

DESCRIPTION

The MP2105 is a 1MHz constant frequency, current mode, PWM step-down converter. The device integrates a main switch and a synchronous rectifier for high efficiency without an external Schottky diode. It is ideal for powering portable equipment that runs from a single cell Lithium-Ion (Li+) battery. The MP2105 can supply 800mA of load current from a 2.5V to 6V input voltage. The output voltage can be regulated as low as 0.6V. The MP2105 can also run at 100% duty cycle for low dropout applications.

The MP2105 is available in a low profile (1mm) 5-pin, TSOT and 10-pin, MSOP packages.

FEATURES

- High Efficiency: Up to 95%
- 1MHz Constant Switching Frequency
- 800mA Available Load Current
- 2.5V to 6V Input Voltage Range
- Output Voltage as Low as 0.6V
- 100% Duty Cycle in Dropout
- Current Mode Control
- Short Circuit Protection
- Thermal Fault Protection
- $0.1\mu\text{A}$ Shutdown Current
- Space Saving 5-Pin TSOT23 and 10-pin MSOP Packages

APPLICATIONS

- Cellular and Smart Phones
- Microprocessors and DSP Core Supplies
- PDAs
- MP3 Players
- Digital Still and Video Cameras
- Portable Instruments

All MPS parts are lead-free and adhere to the RoHS directive. For MPS green status, please visit MPS website under Products, Quality Assurance page.

"MPS" and "The Future of Analog IC Technology" are registered trademarks of Monolithic Power Systems, Inc.

TYPICAL APPLICATION

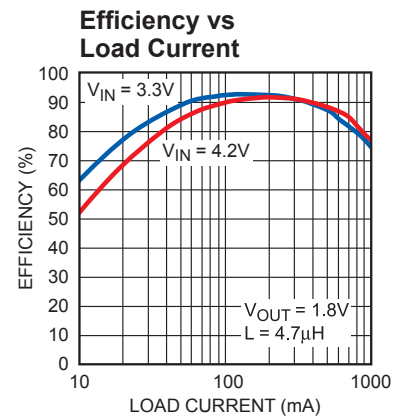
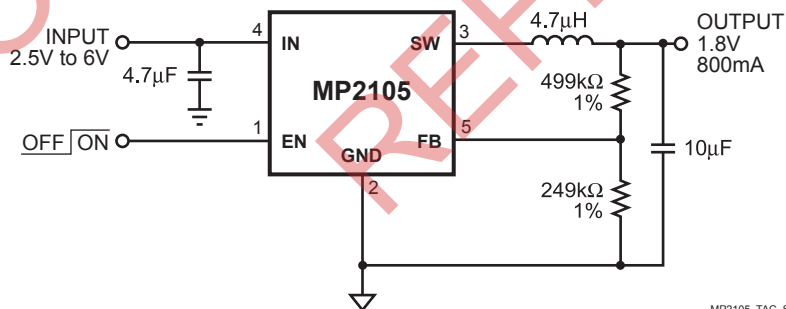

ORDERING INFORMATION

Part Number	Package	Top Marking	Free Air Temperature (T _A)
MP2105DJ*	TSOT23-5	C5	-40°C to +85°C
MP2105DK**	MSOP10	2105D	-40°C to +85°C

* For Tape & Reel, add suffix -Z (g. MP2105DJ-Z).

For RoHS compliant packaging, add suffix -LF (e.g. MP2105DJ-LF-Z)

** For Tape & Reel, add suffix -Z (g. MP2105DK-Z).

For RoHS compliant packaging, add suffix -LF (e.g. MP2105DK-LF-Z)

PACKAGE REFERENCE

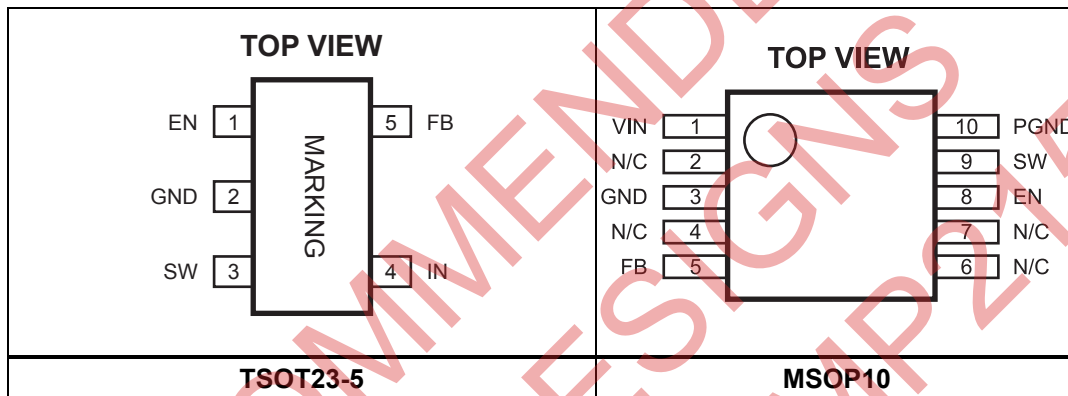

Absolute Maximum Ratings ⁽¹⁾

V _{IN} to GND	-0.3V to +6.5V
V _{SW} to GND	-0.3V to V _{IN} +0.3V
V _{FB} , V _{EN} to GND	-0.3V to +6.5V
Continuous Power Dissipation (T _A = +25°C) ⁽²⁾	
TSOT23-5	0.56W
MSOP10	0.83W
Junction Temperature	+150°C
Lead Temperature	+260°C
Storage Temperature	-65°C to +150°C

Recommended Operating Conditions ⁽³⁾

Supply Voltage V _{IN}	2.5V to 6V
Output Voltage V _{OUT}	0.6V to 6V
Operating Junct. Temp.	-40°C to +125°C

Thermal Resistance ⁽⁴⁾

	θ _{JA}	θ _{JC}
TSOT23-5	220	110
MSOP10	150	65

Notes:

- Exceeding these ratings may damage the device.
- The maximum allowable power dissipation is a function of the maximum junction temperature T_J (MAX), the junction-to-ambient thermal resistance θ_{JA}, and the ambient temperature T_A. The maximum allowable continuous power dissipation at any ambient temperature is calculated by P_D (MAX) = (T_J (MAX) - T_A) / θ_{JA}. Exceeding the maximum allowable power dissipation will cause excessive die temperature, and the regulator will go into thermal shutdown. Internal thermal shutdown circuitry protects the device from permanent damage.
- The device is not guaranteed to function outside of its operating conditions.
- Measured on JESD51-7, 4-layer PCB.

ELECTRICAL CHARACTERISTICS ⁽⁵⁾
 $V_{IN} = V_{EN} = 3.6V$, $T_A = +25^{\circ}C$, unless otherwise noted.

Parameter	Symbol	Condition	Min	Typ	Max	Units
Supply Current		$V_{EN} = V_{IN}$, $V_{FB} = 0.65V$		440	600	μA
Shutdown Current		$V_{EN} = 0V$, $V_{IN} = 6V$		0.10	1	μA
IN Undervoltage Lockout Threshold		Rising Edge	2.15	2.30	2.40	V
IN Undervoltage Lockout Hysteresis				55		mV
Regulated FB Voltage	V_{FB}	$T_A = +25^{\circ}C$	0.588	0.600	0.612	V
		$-40^{\circ}C \leq T_A \leq +85^{\circ}C$	0.582	0.600	0.618	
FB Input Bias Current		$V_{FB} = 0.65V$	-50	0.5	+50	nA
PFET On Resistance		$I_{SW} = 100mA$		0.42		Ω
NFET On Resistance		$I_{SW} = -100mA$		0.26		Ω
SW Leakage Current		$V_{EN} = 0V$, $V_{IN} = 6V$, $V_{SW} = 0V$ or $6V$	-1		+1	μA
PFET Current Limit		Duty Cycle = 100%, Current Pulse Width < 1ms	1.2	1.6		A
Oscillator Frequency	f_{OSC}		0.85	1.05	1.3	MHz
Thermal Shutdown Trip Threshold				145		$^{\circ}C$
EN Trip Threshold		$-40^{\circ}C \leq T_A \leq +85^{\circ}C$	0.3	0.96	1.5	V
EN Input Current		$V_{EN} = 0V$ to $6V$	-1		+1	μA

Notes:

 5) 100% production test at $+25^{\circ}C$. Specifications over the temperature range are guaranteed by design and characterization.

PIN FUNCTIONS

MSOP Pin #	TSOT Pin #	Name	Description
8	1	EN	Regulator Enable Control Input. Drive EN above 1.5V to turn on the MP2105. Drive EN below 0.3V to turn it off (shutdown current < 0.1µA).
3	2	GND	Ground.
9	3	SW	Power Switch Output. Inductor connection to drains of the internal PFET and NFET switches.
1	4	IN	Supply Input. Bypass to GND with a 2.2µF or greater ceramic capacitor.
5	5	FB	Feedback Input. Connect FB to the center point of the external resistor divider. The feedback threshold voltage is 0.6V.
2, 4, 6, 7		NC	No Connect
10		PGND	Power Ground

NOT RECOMMENDED FOR NEW DESIGNS REFER TO MP2151

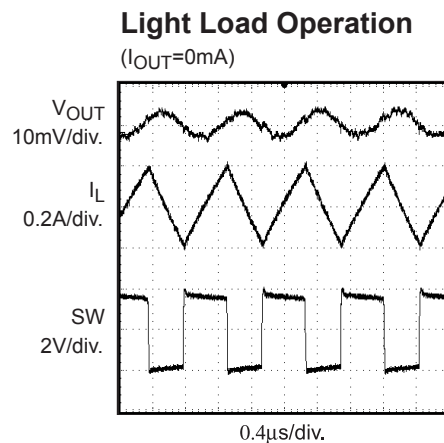
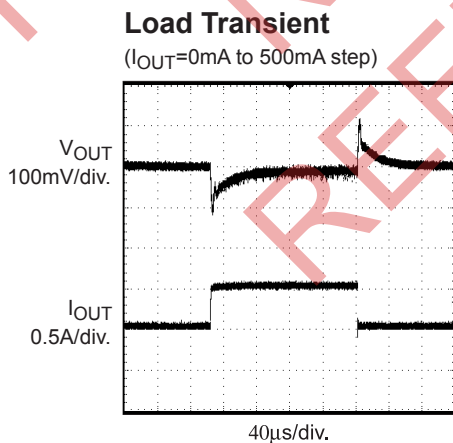
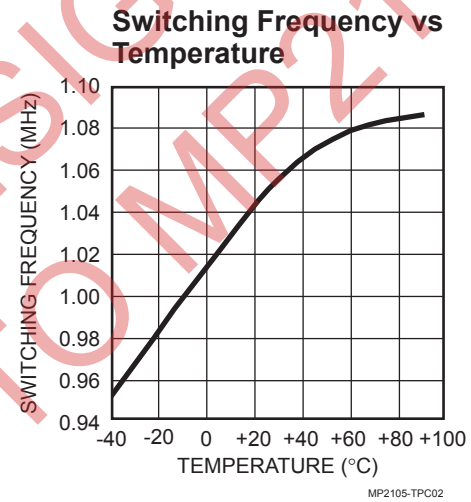
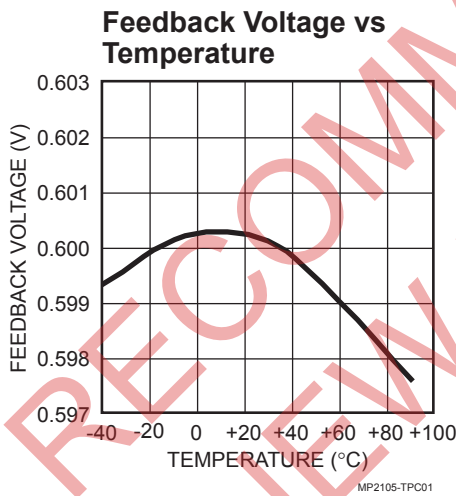
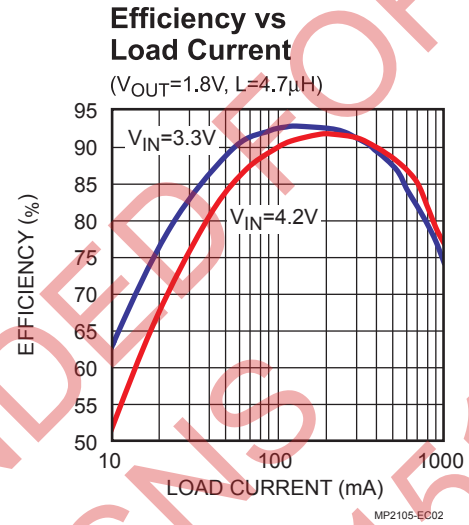
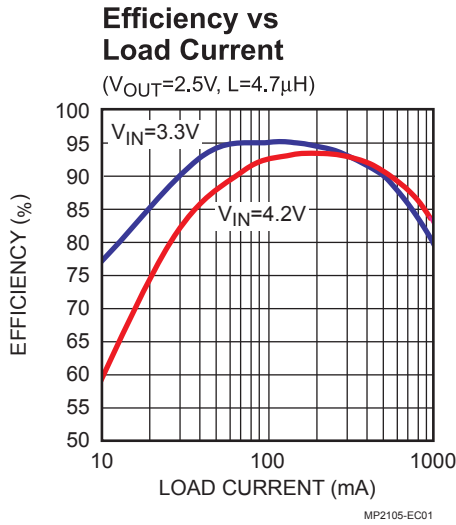
TYPICAL PERFORMANCE CHARACTERISTICS
 $V_{IN} = 3.3V$, $V_{OUT} = 1.8V$, $L1 = 4.7\mu H$, $C1 = 4.7\mu F$, $C3 = 10\mu F$, $T_A = +25^\circ C$, unless otherwise noted.

TYPICAL PERFORMANCE CHARACTERISTICS (continued)
 $V_{IN} = 3.3V$, $V_{OUT} = 1.8V$, $L1 = 4.7\mu H$, $C1 = 4.7\mu F$, $C3 = 10\mu F$, $T_A = +25^\circ C$, unless otherwise noted.

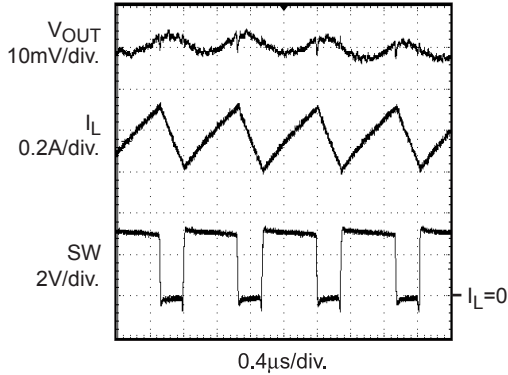
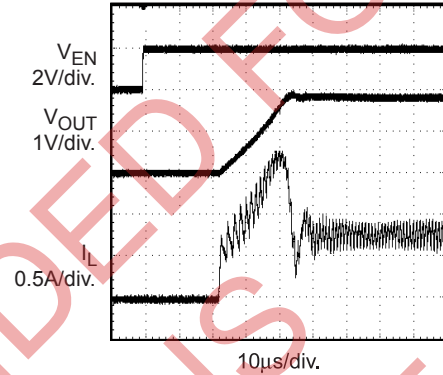
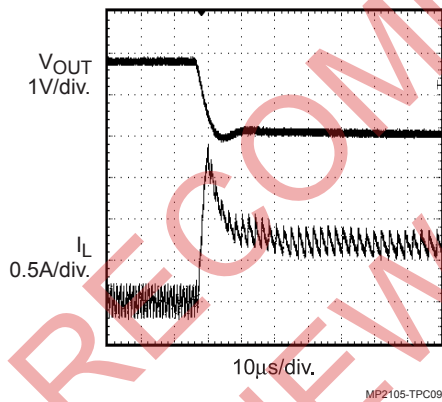
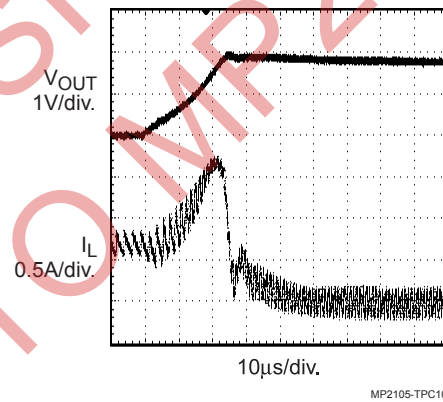
Heavy Load Operation
 $I_{OUT} = 800mA$

Startup from Shutdown

Short Circuit Protection (No Load)

Short Circuit Recovery (No Load)

OPERATION

The MP2105 is a constant frequency current mode PWM step-down converter. The MP2105 is optimized for low voltage, Li-Ion battery powered applications where high efficiency and small size are critical. The MP2105 uses an external resistor divider to set the output voltage from 0.6V to 6V. The device integrates both a main switch and a synchronous rectifier, which provides high efficiency and eliminates

an external Schottky diode. The MP2105 can achieve 100% duty cycle. The duty cycle D of a step-down converter is defined as:

$$D = T_{ON} \times f_{OSC} \times 100\% \approx \frac{V_{OUT}}{V_{IN}} \times 100\%$$

where T_{ON} is the main switch on time, and f_{OSC} is the oscillator frequency (1MHz).

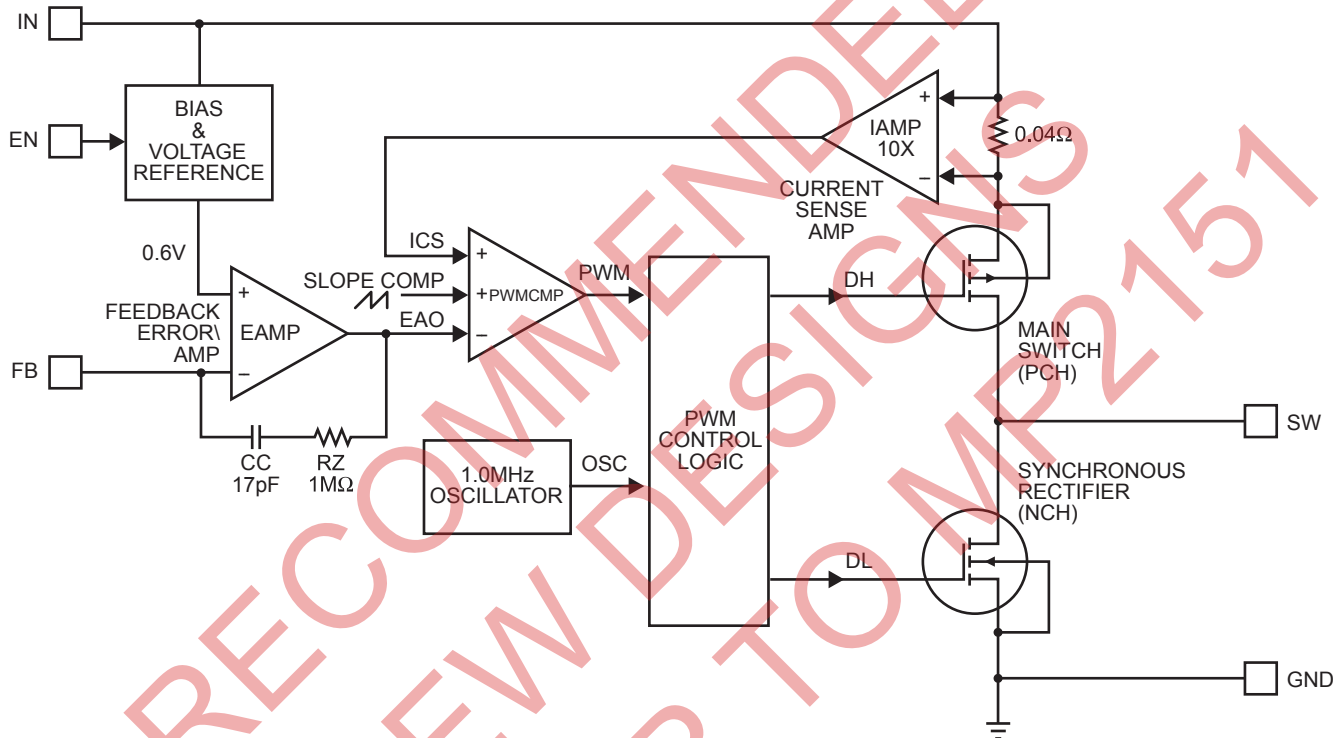

Figure 1—Function Block Diagram

MP2105_BD01

Current Mode PWM Control

Slope compensated current mode PWM control provides stable switching and cycle-by-cycle current limit for superior load and line response and protection of the internal main switch and synchronous rectifier. The MP2105 switches at a constant frequency (1MHz) and regulates the output voltage. During each cycle the PWM comparator modulates the power transferred to the load by changing the inductor peak current based on the feedback error voltage. During normal operation, the main switch is turned on for a certain time to ramp the inductor current at each rising edge of the internal oscillator, and switched off when the peak inductor current is above the error voltage. When the main switch is off, the synchronous rectifier will be turned on immediately and stay on until either the next cycle starts.

Dropout Operation

The MP2105 allows the main switch to remain on for more than one switching cycle and increases the duty cycle while the input voltage is dropping close to the output voltage. When the duty cycle reaches 100%, the main switch is held on continuously to deliver current to the output up to

the PFET current limit. The output voltage then is the input voltage minus the voltage drop across the main switch and the inductor.

Short Circuit Protection

The MP2105 has short circuit protection. When the output is shorted to ground, the oscillator frequency is reduced to prevent the inductor current from increasing beyond the PFET current limit. The PFET current limit is also reduced to lower the short circuit current. The frequency and current limit will return to the normal values once the short circuit condition is removed and the feedback voltage reaches 0.6V.

Maximum Load Current

The MP2105 can operate down to 2.5V input voltage; however the maximum load current decreases at lower input due to large IR drop on the main switch and synchronous rectifier. The slope compensation signal reduces the peak inductor current as a function of the duty cycle to prevent sub-harmonic oscillations at duty cycles greater than 50%. Conversely the current limit increases as the duty cycle decrease

APPLICATION INFORMATION

Output Voltage Setting

The external resistor divider sets the output voltage (see Figure 3). The feedback resistor R1 also sets the feedback loop bandwidth with the internal compensation capacitor (see Figure 1).

Choose R1 around 500kΩ for optimal transient response. R2 is then given by:

$$R2 = \frac{R1}{\frac{V_{OUT}}{0.6V} - 1}$$

Table 1—Resistor Selection vs. Output Voltage Setting

V _{OUT}	R1	R2
1.2V	499kΩ (1%)	499kΩ (1%)
1.5V	499kΩ (1%)	332kΩ (1%)
1.8V	499kΩ (1%)	249kΩ (1%)
2.5V	499kΩ (1%)	158kΩ (1%)

Inductor Selection

A 1μH to 10μH inductor with DC current rating at least 25% higher than the maximum load current is recommended for most applications. For best efficiency, the inductor DC resistance shall be <200mΩ. See Table 2 for recommended inductors and manufacturers. For most designs, the inductance value can be derived from the following equation:

$$L = \frac{V_{OUT} \times (V_{IN} - V_{OUT})}{V_{IN} \times \Delta I_L \times f_{OSC}}$$

where ΔI_L is Inductor Ripple Current. Choose inductor ripple current approximately 30% of the maximum load current, 800mA.

The maximum inductor peak current is:

$$I_{L(MAX)} = I_{LOAD} + \frac{\Delta I_L}{2}$$

Under light load conditions below 100mA, larger inductance is recommended for improved efficiency. Table 3 lists inductors recommended for this purpose.

Table 2—Suggested Surface Mount Inductors

Manufacturer	Part Number	Inductance (μH)	Max DCR (Ω)	Saturation Current (A)	Dimensions L x W x H (mm ³)
Coilcraft	D01605T-472	4.7	0.150	1.20	5.4 x 4.2 x 1.8
Toko	D52LC	4.7	0.087	1.14	5 x 5 x 2
Sumida	CR43-4R7	4.7	0.109	1.15	4.3 x 4.8 x 3.5

Table 3—Inductors for Improved Efficiency at 25mA, 50mA, under 100mA Load.

Manufacturer	Part Number	Inductance (μH)	Max DCR (Ω)	Saturation Current (A)	I _{RMS} (A)
Coilcraft	DO1605T-103MX	10	0.3	1.0	0.9
Murata	LQH4C100K04	10	0.2	1.2	0.8
Sumida	CR32-100	10	0.2	1.0	0.7
Sumida	CR54-100	10	0.1	1.2	1.4

Input Capacitor Selection

The input capacitor reduces the surge current drawn from the input and switching noise from the device. The input capacitor impedance at the switching frequency shall be less than input source impedance to prevent high frequency switching current passing to the input. Ceramic capacitors with X5R or X7R dielectrics are highly recommended because of their low ESR and small temperature coefficients. For most applications, a 4.7μF capacitor is sufficient.

Output Capacitor Selection

The output capacitor keeps output voltage ripple small and ensures regulation loop stable. The output capacitor impedance shall be low at the switching frequency. Ceramic capacitors with X5R or X7R dielectrics are recommended. The output ripple ΔV_{OUT} is approximately:

$$\Delta V_{OUT} \leq \frac{V_{OUT} \times (V_{IN} - V_{OUT})}{V_{IN} \times f_{OSC} \times L} \times \left(ESR + \frac{1}{8 \times f_{OSC} \times C3} \right)$$

PCB layout guide

PCB layout is very important to achieve stable operation. It is highly recommended to duplicate EVB layout for optimum performance.

If change is necessary, please follow these guidelines and take figure 2 for reference.

- 1) Keep the path of switching current short and minimize the loop area formed by Input cap, high-side MOSFET and low-side MOSFET.
- 2) Bypass ceramic capacitors are suggested to be put close to the Vin Pin.

- 3) Ensure all feedback connections are short and direct. Place the feedback resistors and compensation components as close to the chip as possible.
- 4) Route SW away from sensitive analog areas such as FB.
- 5) Connect IN, SW, and especially GND respectively to a large copper area to cool the chip to improve thermal performance and long-term reliability.

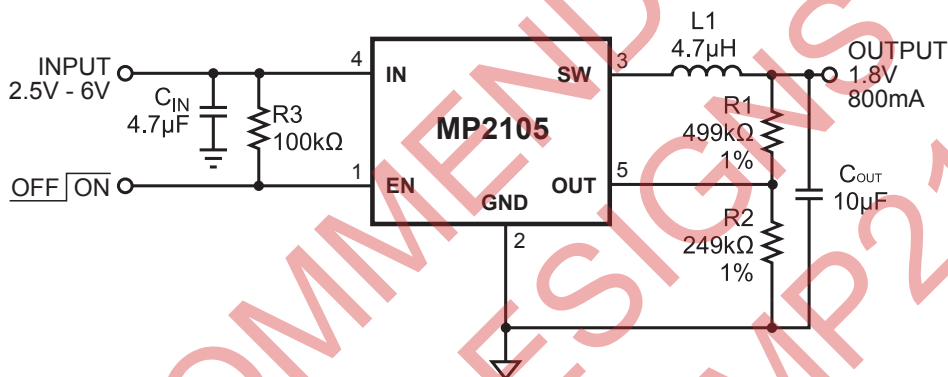
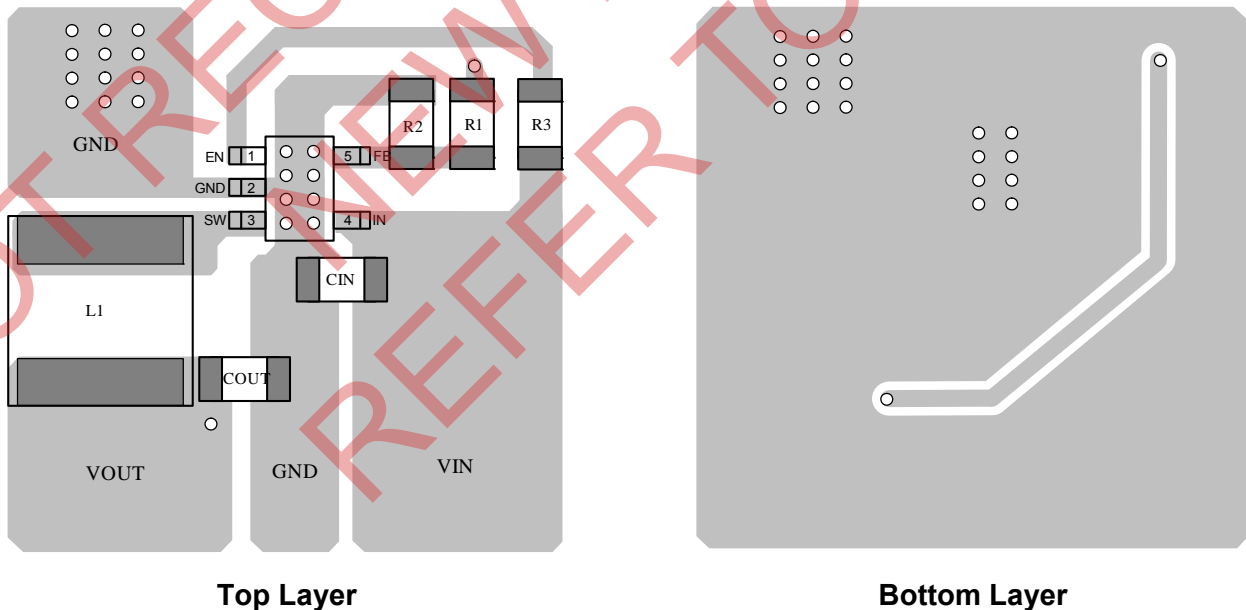

Figure 2 —MP2105 Typical Application Circuit



Top Layer

Bottom Layer

Figure 3—MP2105 Suggested Layout (TQFN)

PACKAGE INFORMATION

TSOT23-5

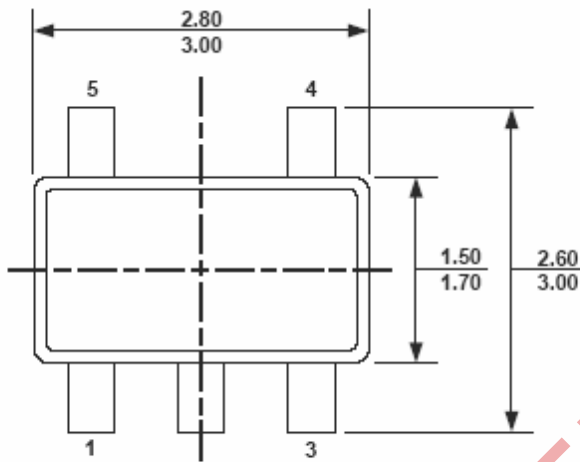

TOP VIEW

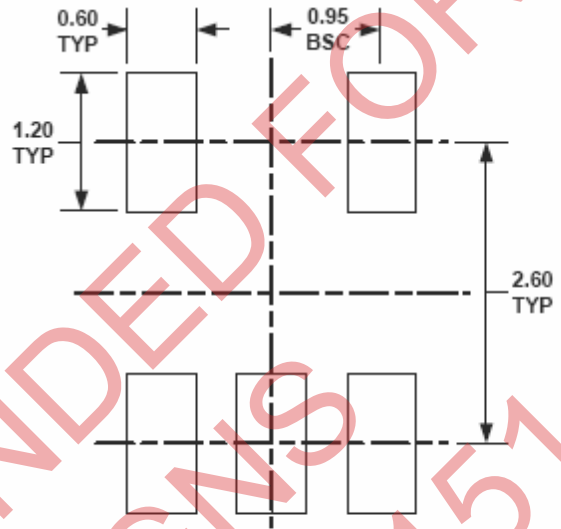

RECOMMENDED LAND PATTERN

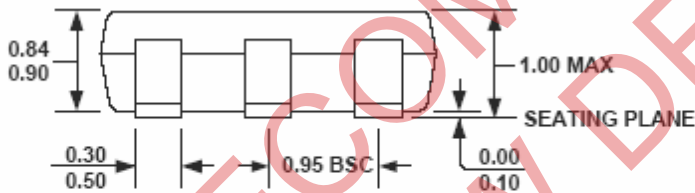

FRONT VIEW

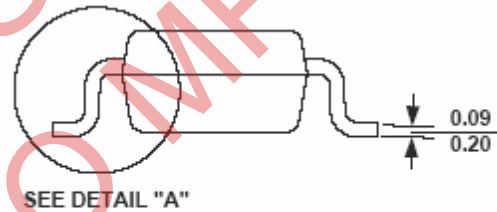

SIDE VIEW

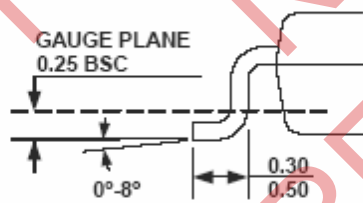

DETAIL "A"

NOTE:

- 1) ALL DIMENSIONS ARE IN MILLIMETERS.
- 2) PACKAGE LENGTH DOES NOT INCLUDE MOLD FLASH, PROTRUSION OR GATE BURR.
- 3) PACKAGE WIDTH DOES NOT INCLUDE INTERLEAD FLASH OR PROTRUSION.
- 4) LEAD COPLANARITY (BOTTOM OF LEADS AFTER FORMING) SHALL BE 0.10 MILLIMETERS MAX.
- 5) DRAWING CONFORMS TO JEDEC MO-193, VARIATION AA.
- 6) DRAWING IS NOT TO SCALE.

MSOP10

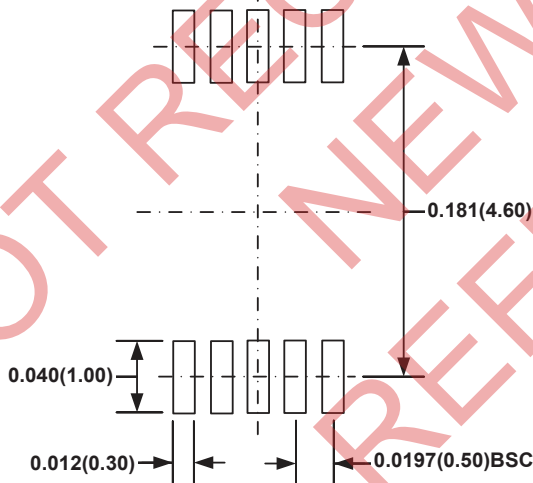
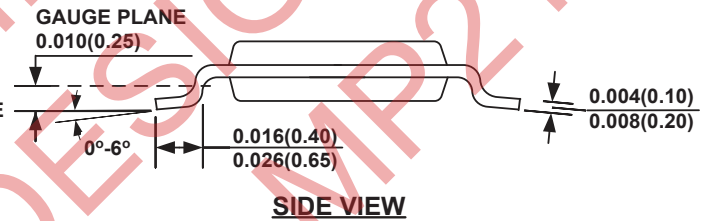
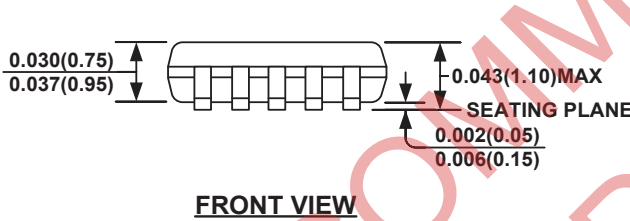
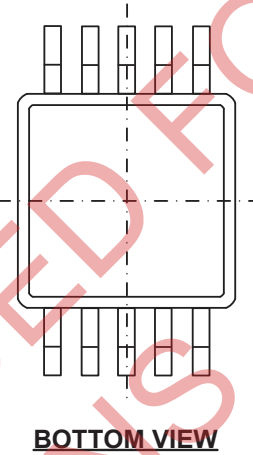
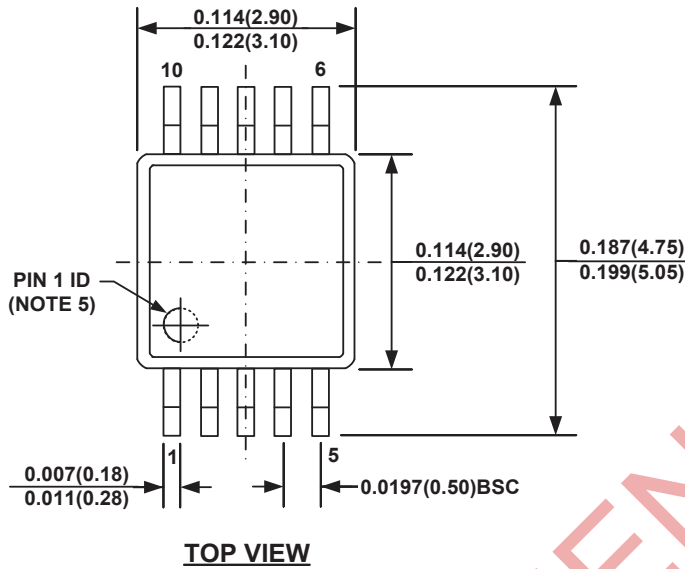

NOTE:

- 1) CONTROL DIMENSION IS IN INCHES. DIMENSION IN BRACKET IS IN MILLIMETERS.
- 2) PACKAGE LENGTH DOES NOT INCLUDE MOLD FLASH, PROTRUSION OR GATE BURR.
- 3) PACKAGE WIDTH DOES NOT INCLUDE INTERLEAD FLASH OR PROTRUSION.
- 4) LEAD COPLANARITY (BOTTOM OF LEADS AFTER FORMING) SHALL BE 0.004" INCHES MAX.
- 5) PIN 1 IDENTIFICATION HAS THE HALF OR FULL CIRCLE OPTION.
- 6) DRAWING MEETS JEDEC MO-817, VARIATION BA.
- 7) DRAWING IS NOT TO SCALE.

NOTICE: The information in this document is subject to change without notice. Please contact MPS for current specifications. Users should warrant and guarantee that third party Intellectual Property rights are not infringed upon when integrating MPS products into any application. MPS will not assume any legal responsibility for any said applications.