

GENERAL DESCRIPTION

This document describes the specifications for the IDTF1102 Zero-Distortion™ RF to IF Downconverting Mixer. This device is part of a series of downconverting mixers covering all UTRA bands. See the Part# Matrix for the details of all devices in the series.

The F1102 dual channel device operates with a single 5V supply. It is optimized for operation in a Multi-carrier BaseStation Receiver for RF bands from 698 to 915 MHz with High or Low Side Injection. IF frequencies from 50 to 300 MHz are supported. The F1102 also supports the 400 MHz RF bands with some simple external matching modifications (see page 25). Nominally, the device offers +43 dBm Output IP3 with 330 mA of I_{CC} . Alternately one can adjust 4 resistor values and a toggle pin to run the devices in low current mode (LC mode) with +36 dBm Output IP3 and 235 mA of I_{CC} .

COMPETITIVE ADVANTAGE

In typical basestation receivers the mixer limits the linearity performance for the entire receive system. The F1102 with Zero-Distortion technology dramatically improves the maximum IM_3 interference that the BTS can withstand at a desired Signal to Noise Ratio (SNR.) Alternately, one can run the device in LC Mode to reduce Power consumption significantly.

- ✓ $IP3_0$: \uparrow **7 dB** STD Mode, \uparrow **3 dB** LC Mode
- ✓ Dissipation: \downarrow **40%** LC Mode, \downarrow **12%** STD Mode
- ✓ Allows for higher RF gain improving **Sensitivity**

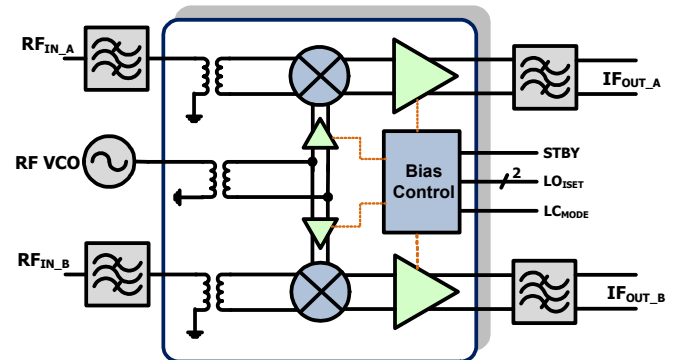

FEATURES

- Dual Path for Diversity Systems
- Ideal for Multi-Carrier Systems
- 9.0 dB Gain
- Ultra linear:
 - **+43 dBm $IP3_0$ (STD Mode)**
 - +36 dBm $IP3_0$ (LC Mode)
- Low NF < 10 dB
- Extended LO level range for MIMO (-6 dBm)
- 200 Ω output impedance
- Ultra high +13 dBm P1dB_I
- **Pin Compatible** with existing solutions
- 6x6 36 pin package
- **Power Down mode**
- < 200 nsec settling from Power Down
- Minimizes Synth pulling in Standby Mode
- Low Current Mode : $I_{CC} = 235$ mA
- Standard Mode: $I_{CC} = 330$ mA

DEVICE BLOCK DIAGRAM

PART# MATRIX

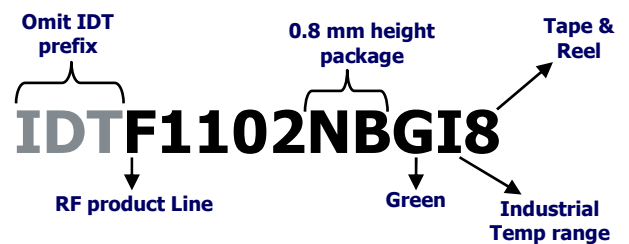
Part#	RF freq range	UTRA bands	IF freq range	Typ. Gain	Injection
F1100	698 - 915	5,6,8,12,13,14,17,19,20	150 - 450	8.3	High Side
F1102	400 - 1000	5,6,8,12,13,14,17,19,20	50 - 300	9.0	Both
F1150 ²	1700 - 2200	1,2,3,4,9,10, 33, 34,35, 36, 37,39	50 - 450	8.5	High Side
F1152	1400 - 2200	1,2,3,4,9,10, 21 ¹ , 24 ¹ , 33, 34,35, 36, 37,39	50 - 350	8.5	Low Side
F1162	2300 – 2700	7,38,40,41 ²	50 – 500	8.8	Low Side

1 - with High side injection
2 - With High side or Low side injection

ORDERING INFORMATION

ABSOLUTE MAXIMUM RATINGS

VCC to GND	-0.3V to +5.5V
STBY, LC _{MODE}	-0.3V to (VCC ₋ + 0.3V)
IF_A+, IF_B+, IF_A-, IF_B-, LO1_ADJ, LO2_ADJ	-0.3V to (VCC ₋ + 0.3V)
LO_IN, LO_IN_ALT, RF_A, RF_B	-0.3V to +0.3V
IF_BiasA, IF_BiasB to GND	-0.3V to +0.3V
RF Input Power (RF_A, RF_B)	+20dBm
Continuous Power Dissipation	2.2W
θ_{JA} (Junction – Ambient)	+35°C/W
θ_{JC} (Junction – Case) The Case is defined as the exposed paddle	+2.5°C/W
Operating Temperature Range (Case Temperature)	T _C = -40°C to +100°C
Maximum Junction Temperature	150°C
Storage Temperature Range	-65°C to +150°C
Lead Temperature (soldering, 10s) .	+260°C

Stresses above those listed above may cause permanent damage to the device. Functional operation of the device at these or any other conditions above those indicated in the operational section of this specification is not implied. Exposure to absolute maximum rating conditions for extended periods may affect device reliability.

IDTF1102 SPECIFICATION (400 – 1000 MHz MIXER w/HIGH OR LOW SIDE INJECTION)

Specifications apply at $V_{CC} = +5.0V$, $F_{RF} = 850 \text{ MHz}$, $F_{IF} = 200 \text{ MHz}$, Hi-Side, $P_{LO} = 0 \text{ dBm}$, $T_C = +25^\circ\text{C}$, $STBY = GND$, $LC_{MODE} = V_{IH}$ (STD Mode), EVKit BOM = Standard Mode, Transformer Loss included (not de-embedded) unless otherwise noted.

Parameter	Comment	Symbol	min	typ	max	units
Logic Input High	For Standby, LC_{MODE} Pins	V_{IH}	2			V
Logic Input Low	For Standby, LC_{MODE} Pins	V_{IL}			0.8	V
Logic Current	For Standby Pin	I_{IH}, I_{IL}	-30		+30	μA
Logic Current	LC_{MODE} Pin	I_{IH}, I_{IL}	-100		-20	μA
Supply Voltage(s)	All V_{CC} pins	V_{CC}		4.75 to 5.25		V
Operating Temperature	Case Temperature	T_{CASE}		-40 to +100		degC
Supply Current	Total V_{CC} , STD Mode ▪ Total Both Channels	I_{STD}		330	370¹	mA
Supply Current	Total V_{CC} , LC Mode ▪ $LC_{MODE} = GND$ ▪ EVkit BOM = LC Mode ▪ Total Both Channels	I_{LC}		235	260	mA
Supply Current	Standby Mode ▪ $STBY = V_{IH}$ ▪ Total Both Channels ▪ STD Mode	I_{STBY}		22	30	mA
RF Freq Range	Operating Range	F_{RF}		400 ³ – 1000		MHz
IF Freq Range	Operating Range	F_{IF}		50 to 300		MHz
LO Freq Range	Operating LO Range	F_{LO}		500 to 1150		MHz
LO Power	Operating LO Range	P_{LO}		-6 to +6		dBm
RF Input Impedance	Single Ended Return Loss ~17 dB	Z_{RF}		50		Ω
IF Output Impedance	Differential Return Loss ~ 13 dB	Z_{IF}		200		Ω
LO port Impedance	Single Ended Return Loss ~15 dB	Z_{LO}		50		Ω
Settling Time	• Pin = -13 dBm • Gate STBY from V_{IH} to V_{IL} • Time for IF Signal to settle to within 0.1 dB of final value	T_{SETT}		0.175		μsec
Gain STD Mode	Conversion Gain • $F_{RF} = 698 \text{ MHz}$ • $LC_{MODE} = V_{IH}$ • EVkit BOM = STD Mode • $F_{IF} = 150 \text{ MHz}$ (Low Side Inj.)	G_{STD}	8.5	9.2	9.9	dB
Gain LC Mode	Conversion Gain • $F_{RF} = 915 \text{ MHz}$ • $LC_{MODE} = GND$ • EVkit BOM = LC Mode • $F_{IF} = 200 \text{ MHz}$ (High Side Inj.)	G_{LC}	7.8	8.5	9.2	dB

IDTF1102 SPECIFICATION (CONTINUED)

Parameter	Comment	Symbol	min	typ	max	units
NF STD Mode	<ul style="list-style-type: none"> LC_{MODE} = V_{IH} EVkit BOM = STD Mode F_{IF} = 200 MHz (High Side Inj.) 	NF _{STD}		9.5		dB
NF LC Mode	<ul style="list-style-type: none"> LC_{MODE} = GND EVkit BOM = LC Mode F_{IF} = 200 MHz (High Side Inj.) 	NF _{LC}		9.3		dB
NF w/Blocker	<ul style="list-style-type: none"> -100 MHz offset blocker P_{IN} = +10 dBm F_{IF} = 200 MHz 	NF _{BLK}		21.7		dB
Output IP3 – Narrowband	<ul style="list-style-type: none"> P_{IN} = -10 dBm per tone 800 KHz Tone Separation F_{IF} = 200 MHz (High Side Inj.) F_{RF} = 850 MHz 	IP3 _{O1}	39 ²	43		dBm
Output IP3 – Wideband	<ul style="list-style-type: none"> P_{IN} = -10 dBm per tone 15 MHz Tone Separation F_{IF} = 200 MHz (High Side Inj.) 	IP3 _{O2}		42		dBm
Output IP3 – LC _{MODE}	<ul style="list-style-type: none"> P_{IN} = -10 dBm per tone F_{IF} = 200 MHz (High Side Inj.) 800 KHz Tone Separation LC_{MODE} = GND F_{RF} = 915 MHz 	IP3 _{O3}	33	36		dBm
2RF – 2LO rejection	<ul style="list-style-type: none"> P_{RF} = -10 dBm Frequency = F_{RF} + ½ F_{IF} 	2x2		-78		dBc
1 dB Compression	<ul style="list-style-type: none"> Input referred 	P1dB _{I1}	11.9	12.5		dBm
1 dB Compression - LC _{MODE}	<ul style="list-style-type: none"> Input referred LC_{MODE} = GND 	P1dB _{I2}	9.0	10.2		dBm
Gain Comp. w/blocker	<ul style="list-style-type: none"> Blocker → unmodulated tone P_{IN} = +8 dBm, 20 MHz offset Signal Pin Tone = -20 dBm Measure ΔG of signal 	ΔG _{AC}		0.15		dB
Spur: 5RF X -4LO	<ul style="list-style-type: none"> F_{LO} = 1087.5 MHz F_{IF} = 190 MHz (High Side Inj.) Desired F_{RF} = 897.5 MHz Spur Freq = 908 MHz Pin = +5 dBm STD Mode 	SPUR ₁		-97	-89	dBc
Channel Isolation	IF_B Pout vs. IF_A w/ RF_A input	ISO _C	45	51		dB
LO to IF leakage		ISO _{LI}		-22	-15	dBm
RF to IF leakage	Pin = -10 dBm	ISO _{RI}		-26	-20	dBm
LO to RF leakage		ISO _{LR}		-40		dBm

Notes:

- 1 – Items in min/max columns in ***bold italics*** are Guaranteed by Test
- 2 – All other Items in min/max columns are Guaranteed by Design Characterization
- 3 – Normal RF range is 698 – 915 MHz. See Page 25 for modifications for 400 – 500 MHz operation

TYPICAL OPERATING CONDITIONS

Unless otherwise Noted, the following Apply to the Typ Ops Graphs

- 800 KHz Tone Spacing
- High Side injection graphs with 200MHz IF (pages 6 – 10)
- Low Side injection graphs with 150MHz IF (pages 11 – 14)
- Average of Channel A & Channel B
- Pin = – 10 dBm per Tone
- LO port = Pin 19 (Main Port)
- Listed Temperatures are Case Temperature (T_C or T_{CASE} = Case Temperature)
- Where noted, T_A or T_{AMB} = Ambient Temperature
- Transformer losses are de-embedded

TYPICAL OPERATING CONDITIONS [IF = 200 MHz, High Side Injection] (-1-)

Gain vs. T_{CASE}

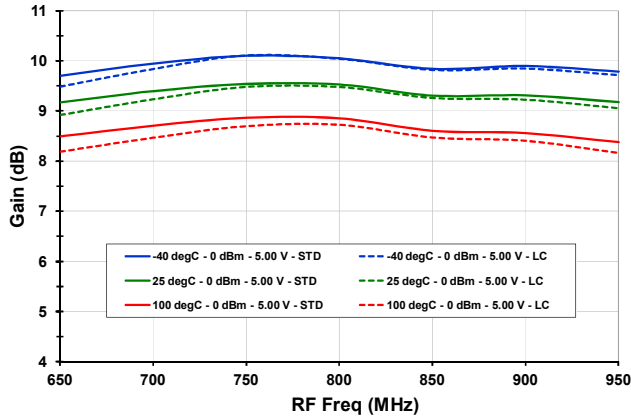

Gain vs. V_{CC}

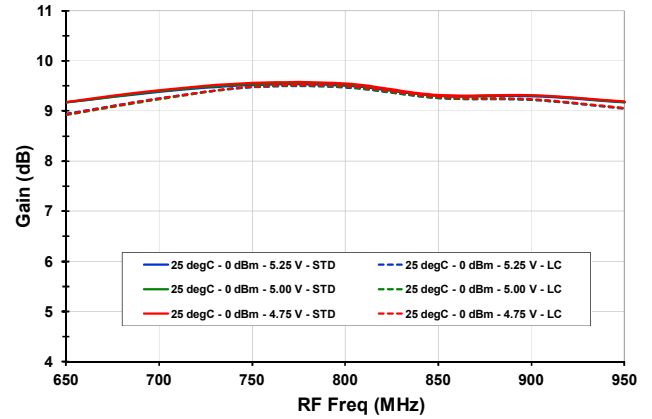

Gain vs. LO Level

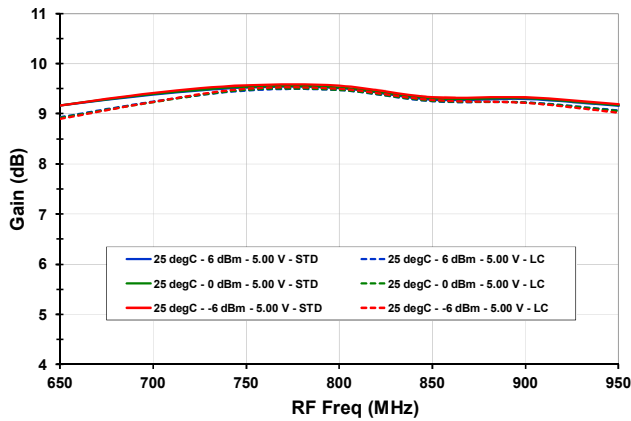

Output IP3 vs. T_{CASE}

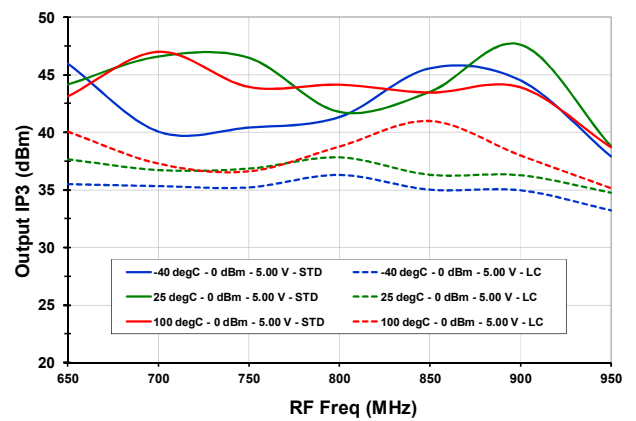

Output IP3 vs. V_{CC}

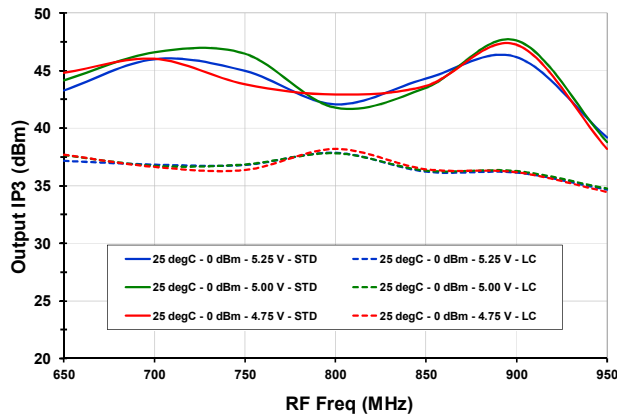

Output IP3 vs. LO Level

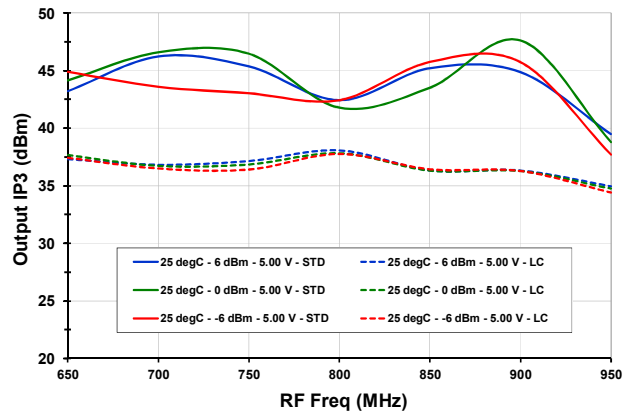

TYPICAL OPERATING CONDITIONS [IF = 200 MHz, High Side Injection] (-2-)

P1dB vs. T_{CASE}

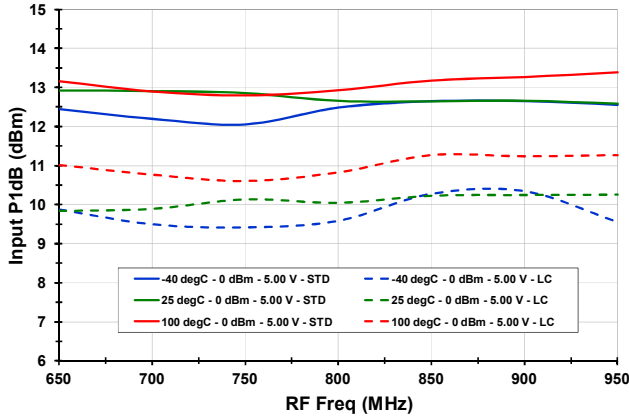

P1dB vs. V_{CC}

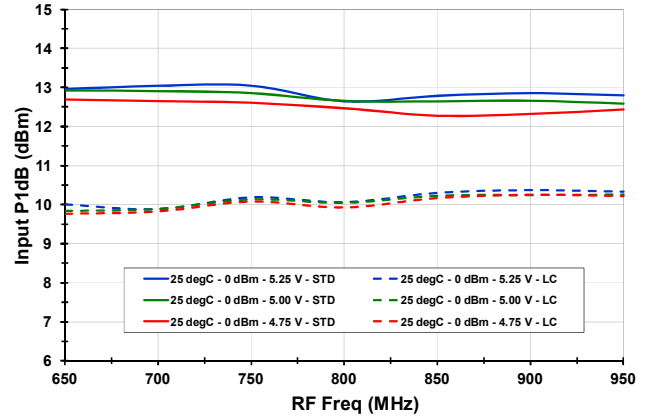

P1dB vs. LO Level

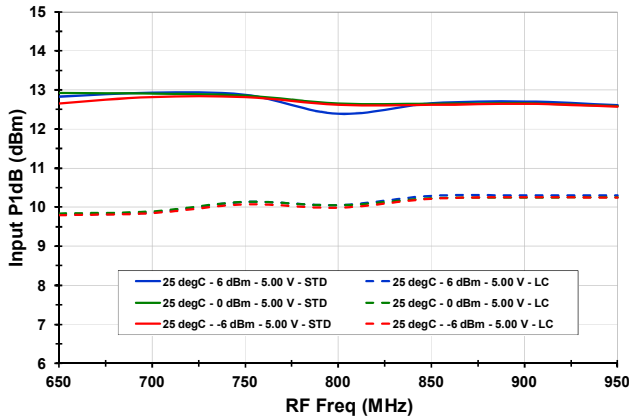

2RF x 2LO rejection vs. T_{CASE}

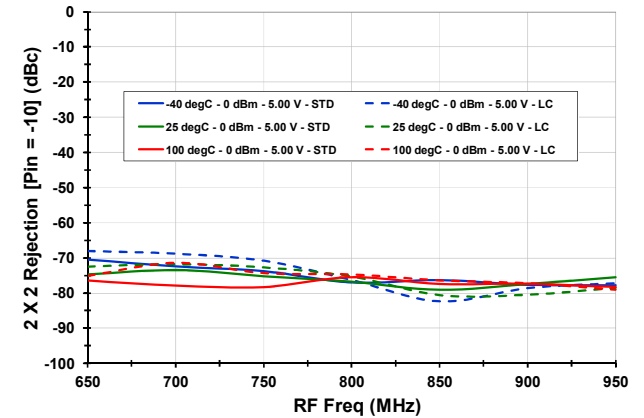

2RF x 2LO Rejection vs. V_{CC}

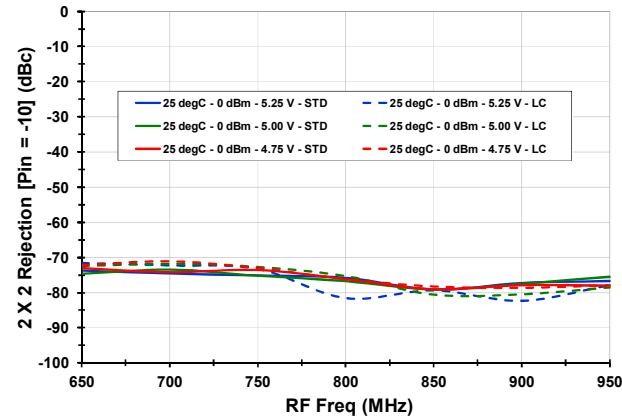

2RF x 2LO Rejection vs. LO Level

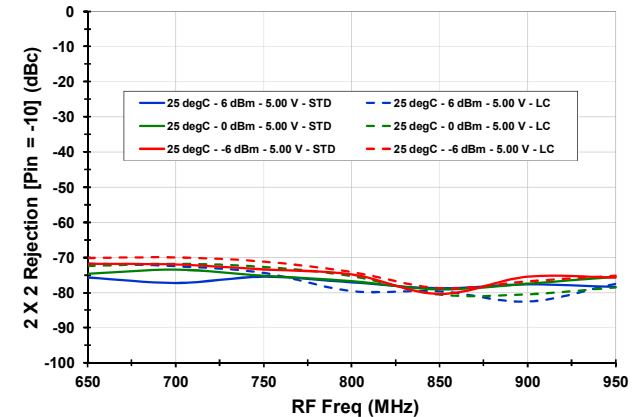

TYPICAL OPERATING CONDITIONS [IF = 200 MHz, High Side Injection] (-3-)

I_{CC} vs. T_{CASE}

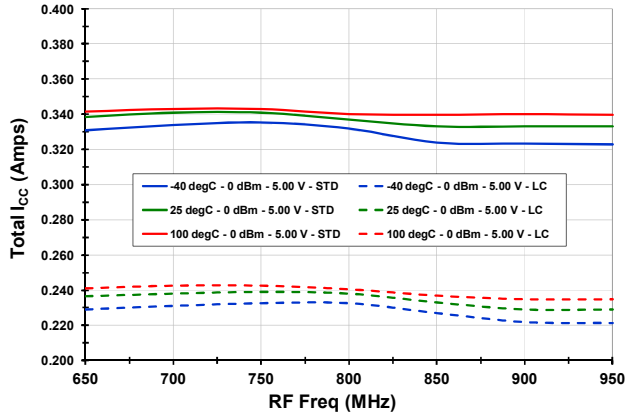

I_{CC} vs. V_{CC}

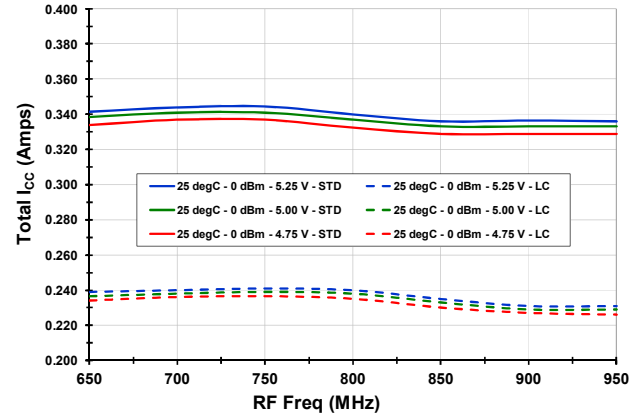

I_{CC} vs. LO Level

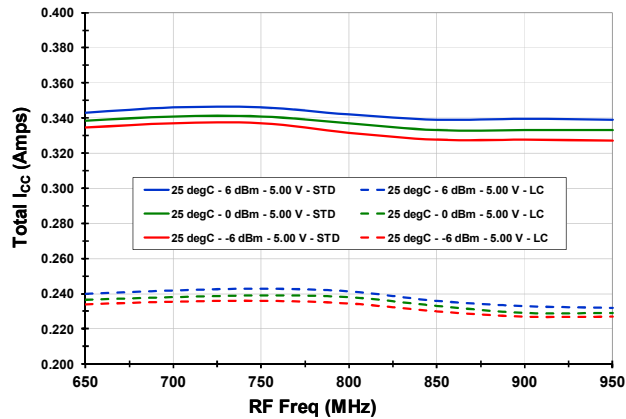

LO-IF Leakage vs. T_{CASE}

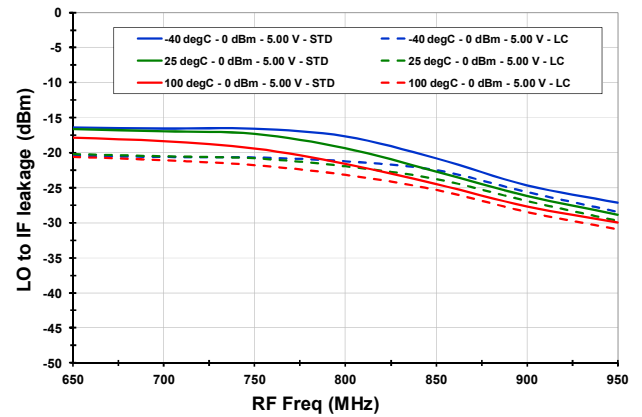

LO-IF Leakage vs. V_{CC}

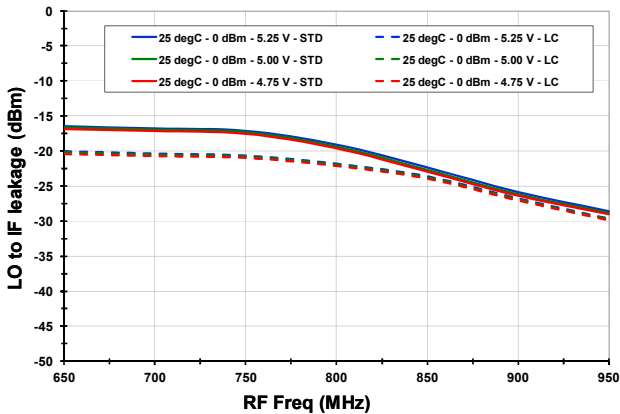

LO-IF Leakage vs. LO Level

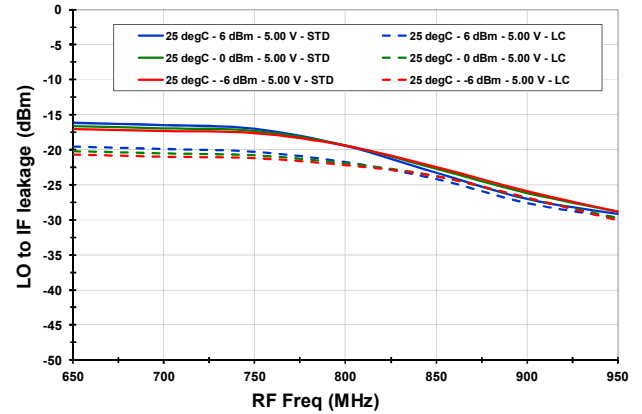

TYPICAL OPERATING CONDITIONS [IF = 200 MHz, High Side Injection] (-4-)

RF-IF Leakage vs. T_{CASE}

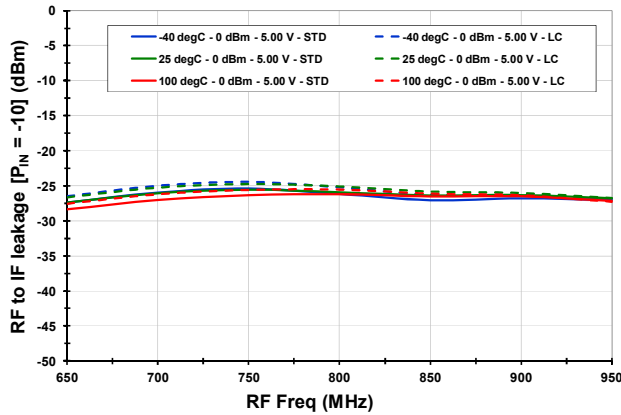

RF-IF Leakage vs. V_{CC}

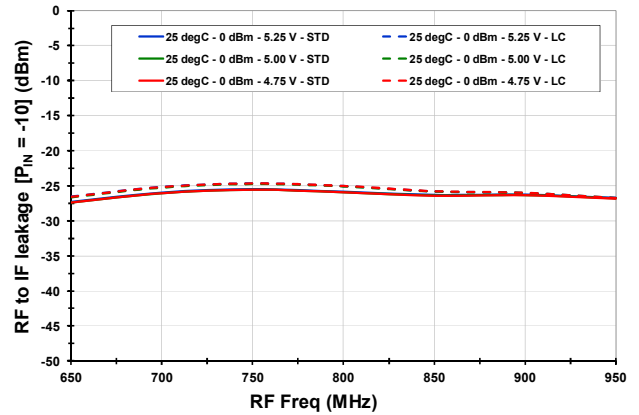

RF-IF Leakage vs. LO Level

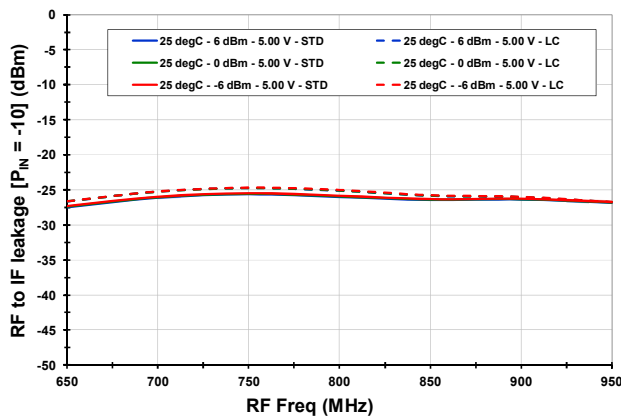

3RF X 3LO Rejection vs. T_{CASE}

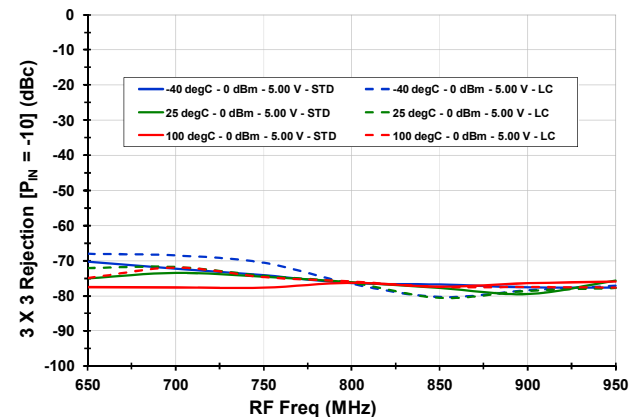

3RF X 3LO Rejection vs. V_{CC}

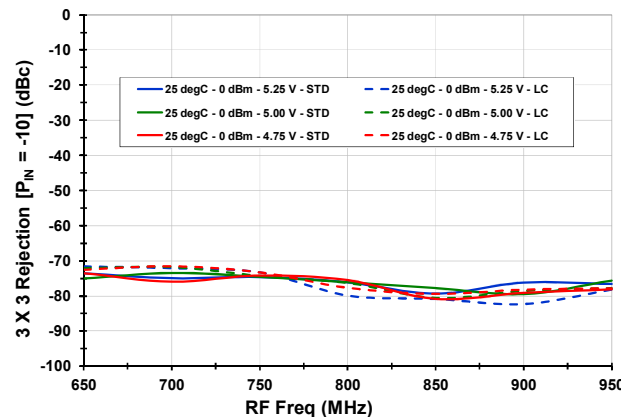

3RF X 3LO Rejection vs. LO Level

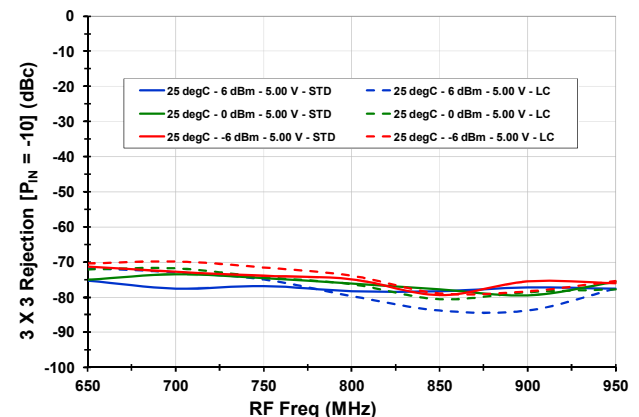

TYPICAL OPERATING CONDITIONS [IF = 200 MHz, High Side Injection] (-5-)

Channel Isolation vs. T_{CASE}

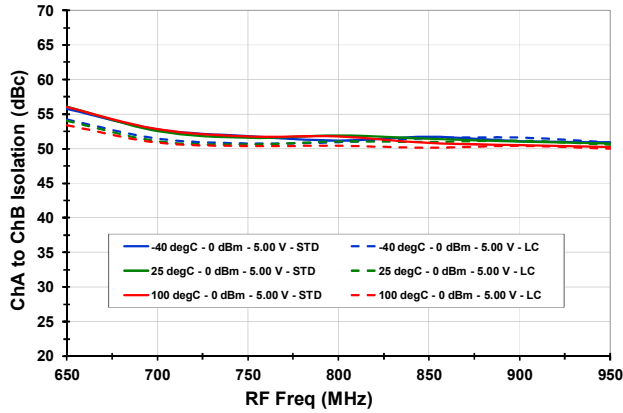

Channel Isolation vs. V_{CC}

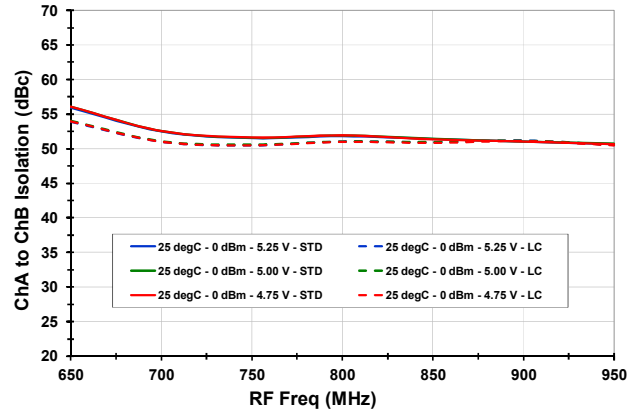

Channel Isolation vs. LO Level

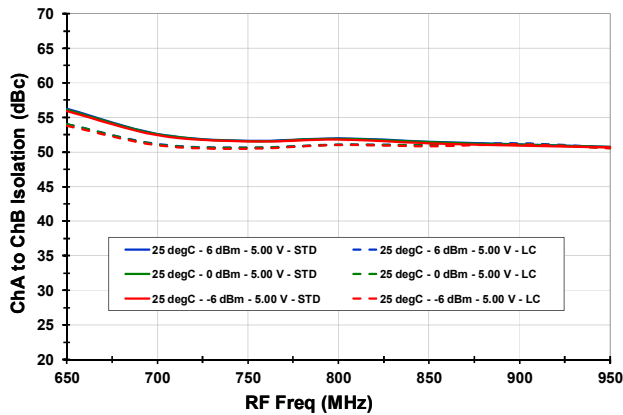

Noise Figure vs. T_{CASE} (LC Mode)

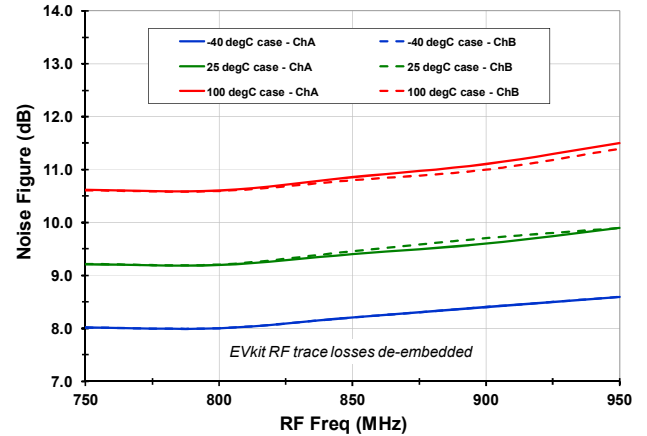

Noise Figure vs. T_{CASE} (STD Mode)

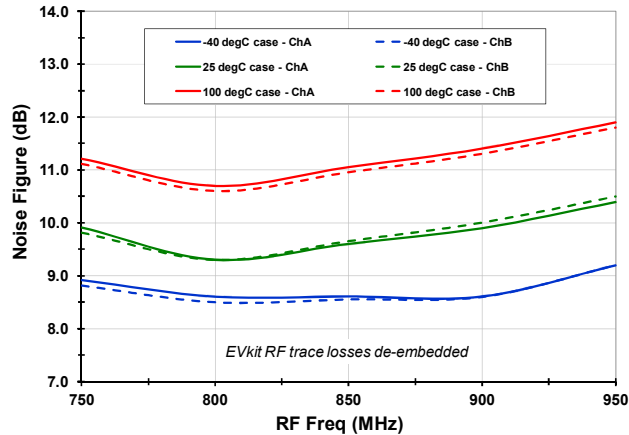

NF vs. Blocker (RF = 850 MHz, IF = 200 MHz, T_A = 25C)

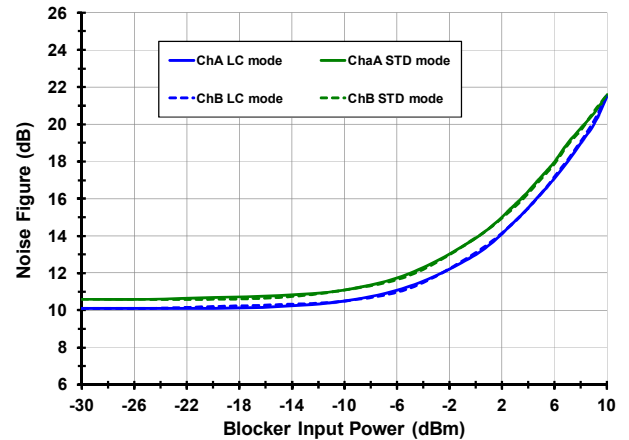

TYPICAL OPERATING CONDITIONS [IF = 150 MHz, Low Side Injection] (-6-)

Gain vs. T_{CASE}

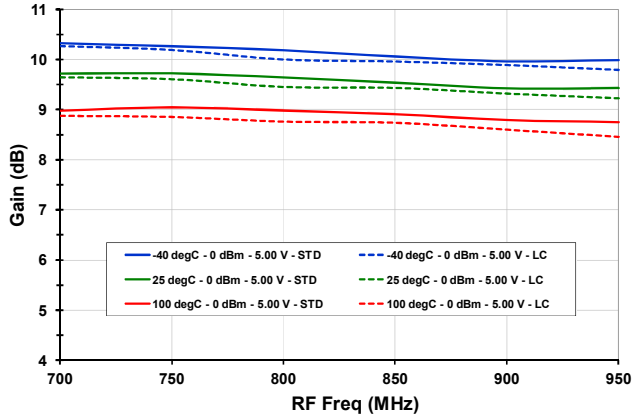

Gain vs. V_{CC}

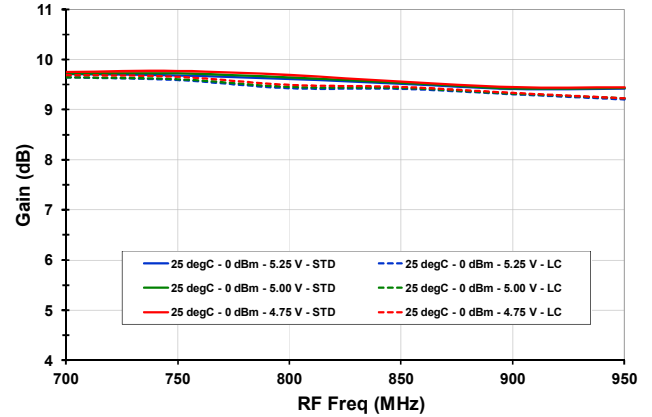

Gain vs. LO level

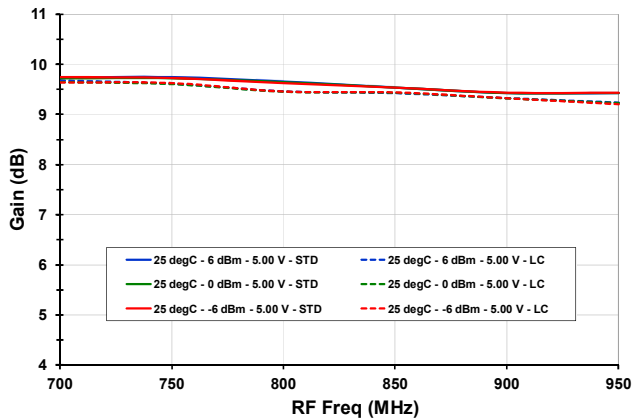

Output IP3 vs. T_{CASE}

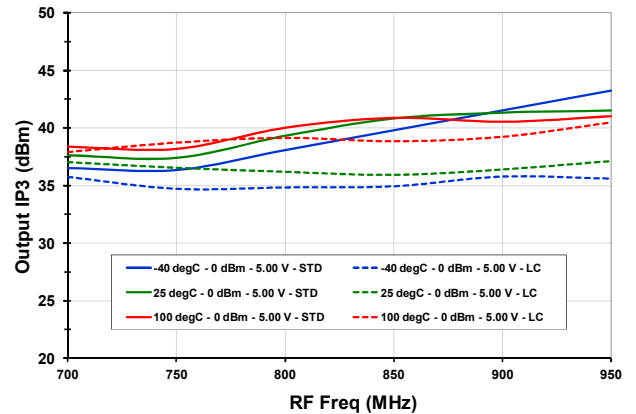

Output IP3 vs. V_{CC}

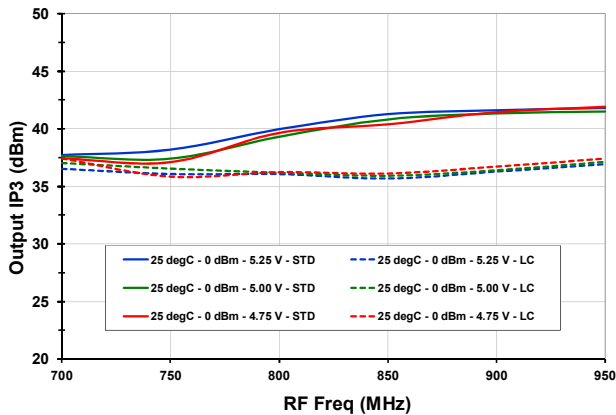

Output IP3 vs. LO Level

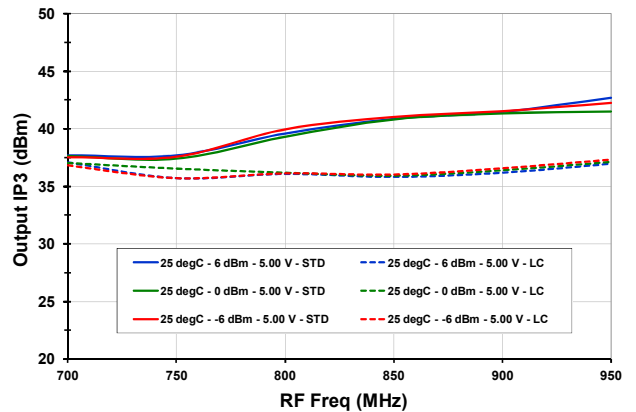

TYPICAL OPERATING CONDITIONS [IF = 150 MHz, Low Side Injection] (-7-)

P1dB vs. T_{CASE}

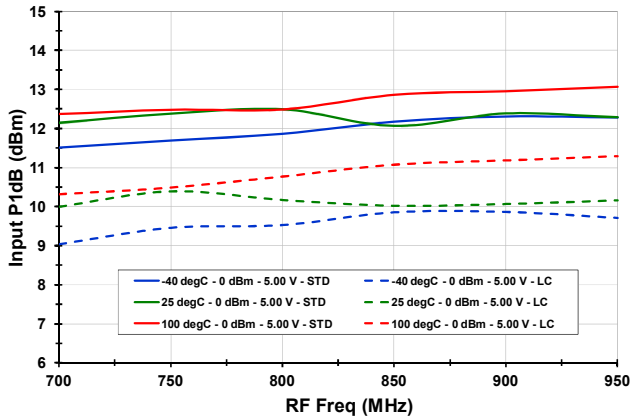

P1dB vs. V_{CC}

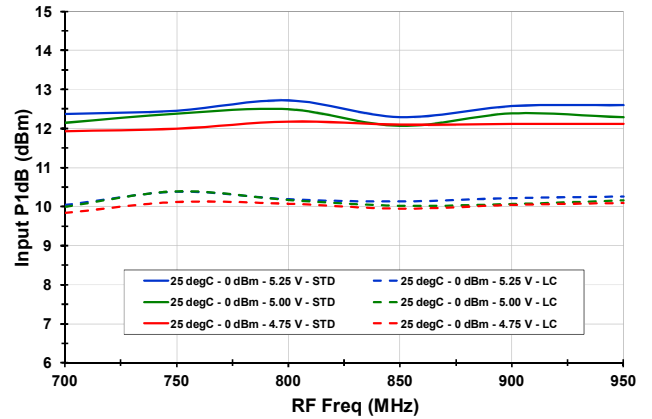

P1dB vs. LO Level

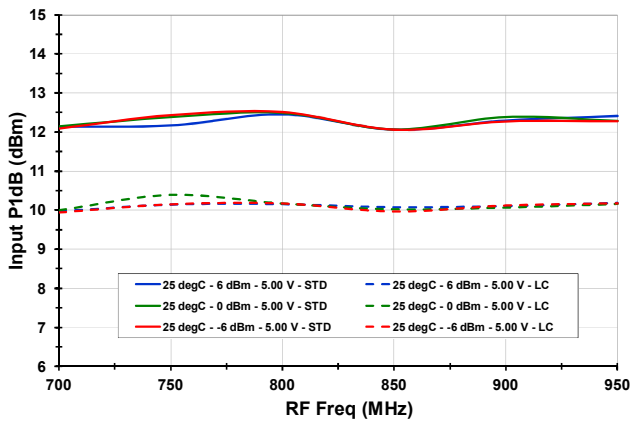

2RF x 2LO rejection vs. T_{CASE}

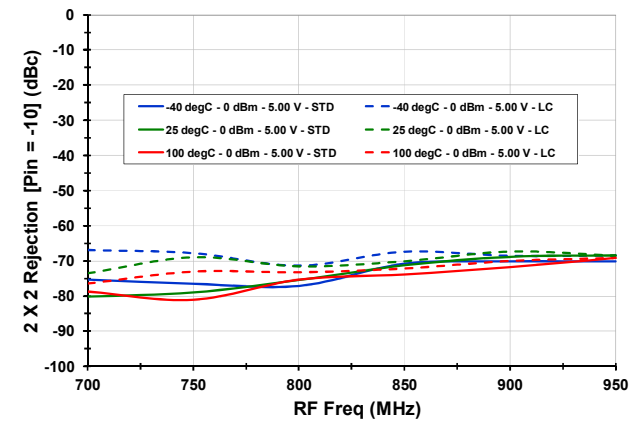

2RF x 2LO Rejection vs. V_{CC}

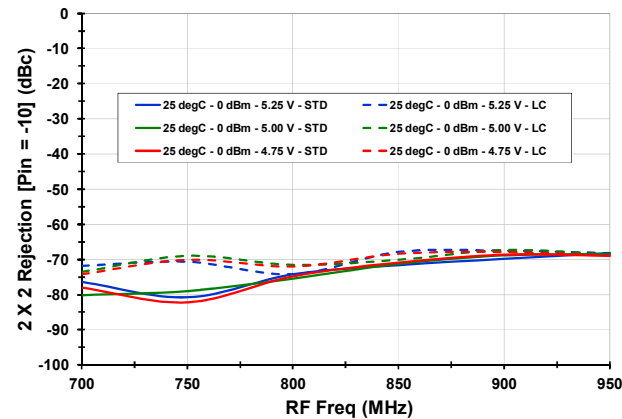

2RF x 2LO rejection vs. LO Level

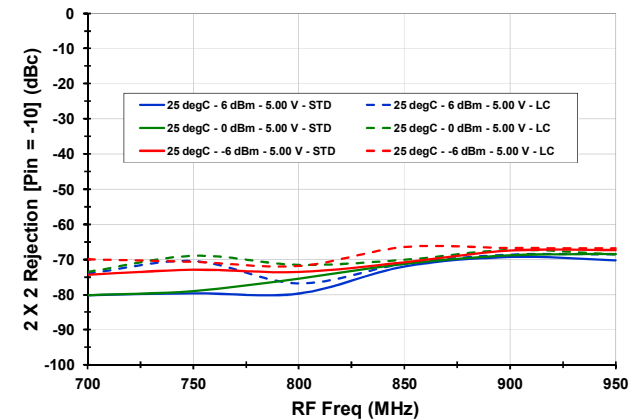

TYPICAL OPERATING CONDITIONS [IF = 150 MHz, Low Side Injection] (-8-)

I_{CC} vs. T_{CASE}

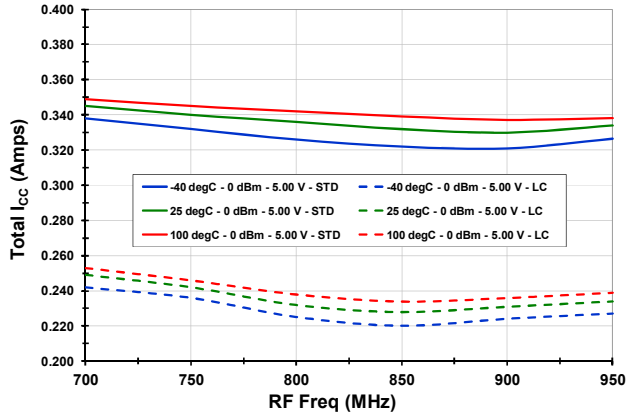

I_{CC} vs. V_{CC}

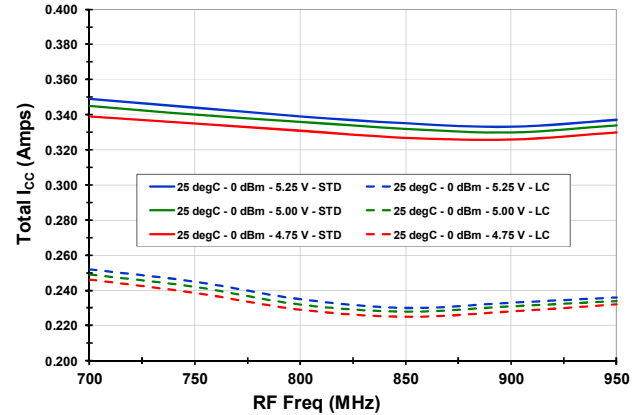

I_{CC} vs. LO Level

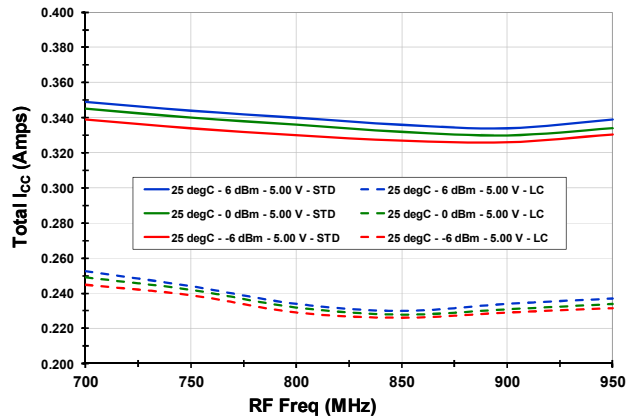

LO-IF Leakage vs. T_{CASE}

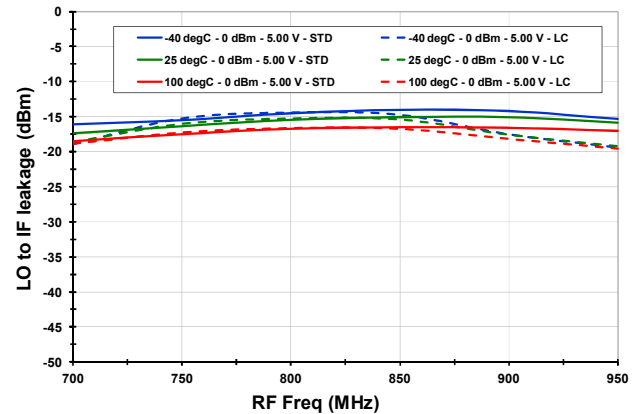

LO-IF Leakage vs. V_{CC}

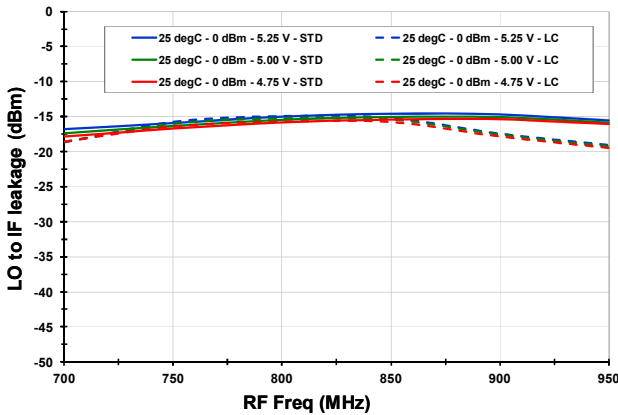

LO-IF Leakage vs. LO Level

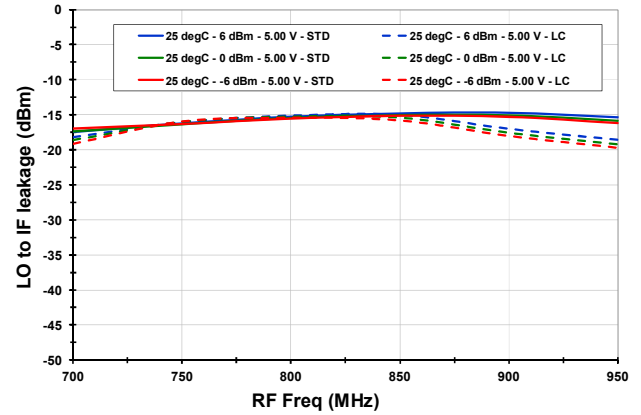

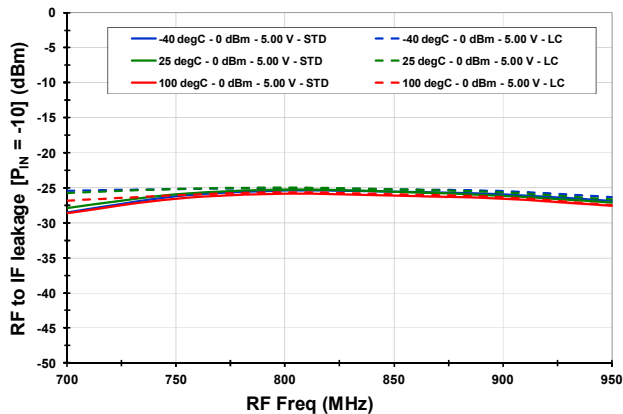
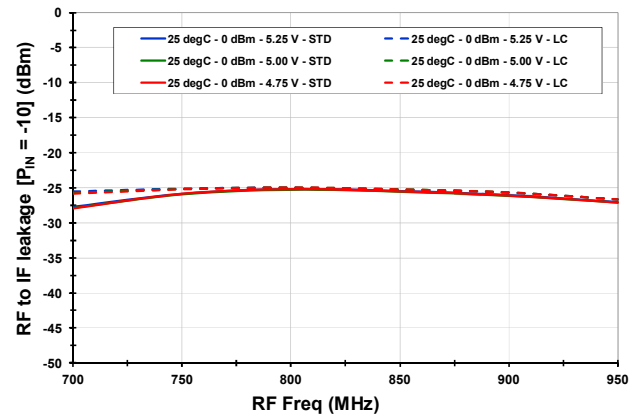
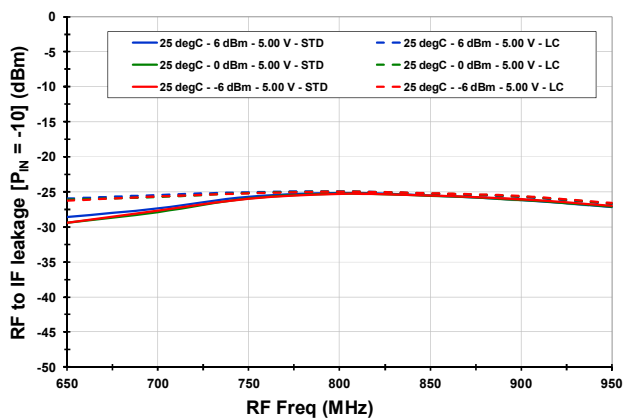
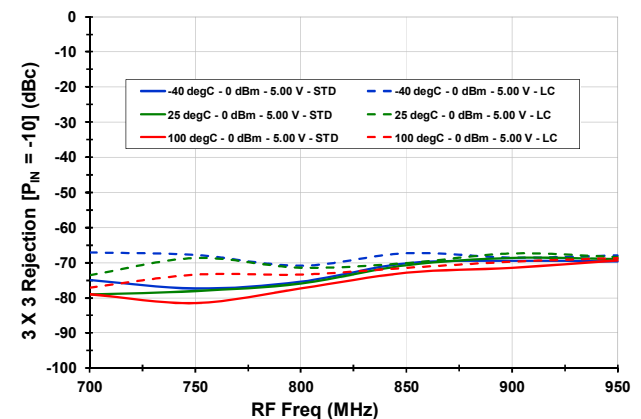
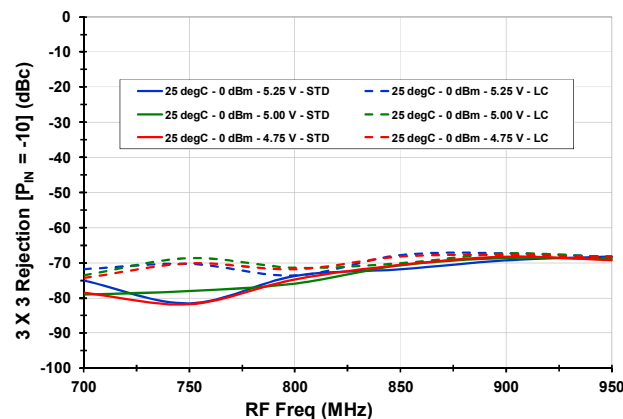
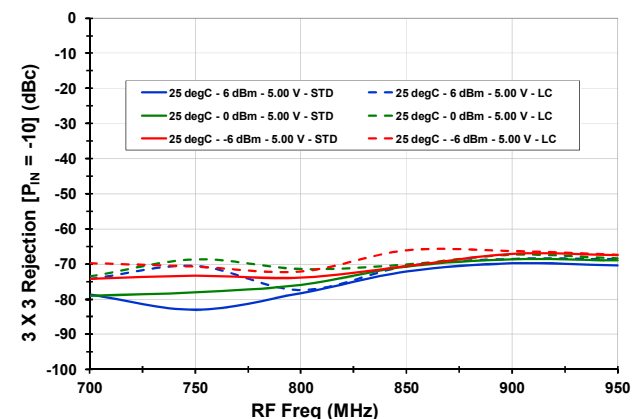
TYPICAL OPERATING CONDITIONS [IF = 150 MHz, Low Side Injection] (-9-)
RF-IF Leakage vs. T_{CASE}

RF-IF Leakage vs. V_{CC}

RF-IF Leakage vs. LO Level

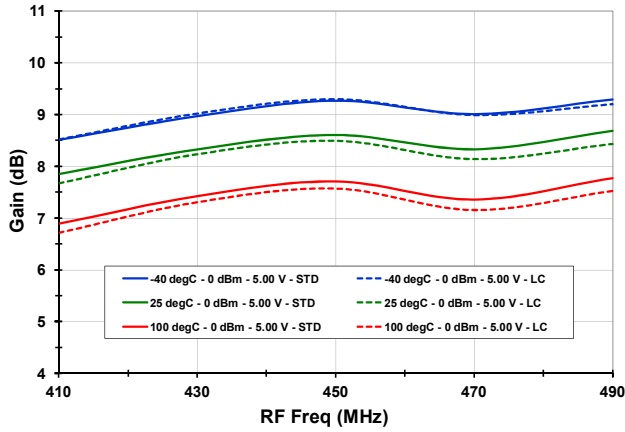
3RF X 3LO Rejection vs. T_{CASE}

3RF X 3LO Rejection vs. V_{CC}

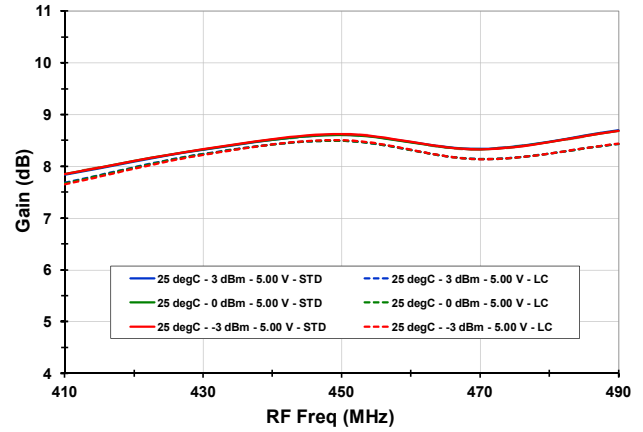
3RF X 3LO Rejection vs. LO Level

TYPICAL OPERATING CONDITIONS [400 MHz Bands see modifications on p. 25] (-10-)

Gain vs. T_{CASE} (130 MHz IF)



Gain vs. LO Level (130 MHz IF)



Output IP3 vs. T_{CASE} (130 MHz IF)

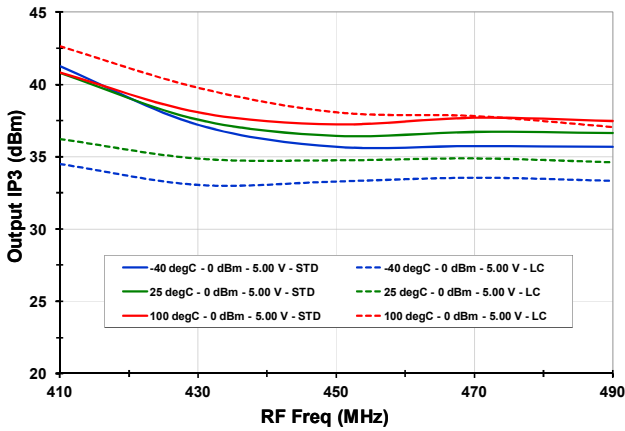

Output IP3 vs. LO Level (130 MHz IF)

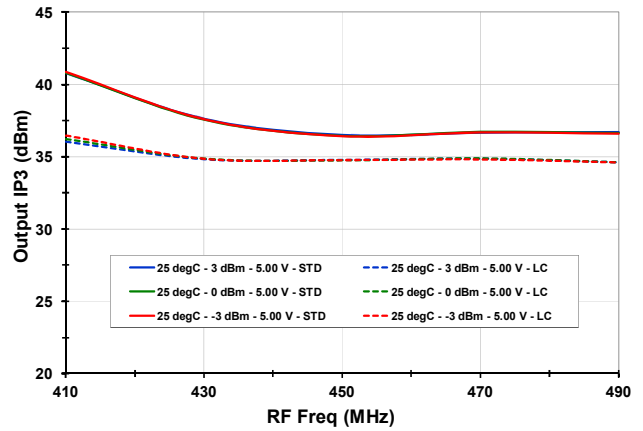

P1dB vs. LO Level (70 MHz IF)

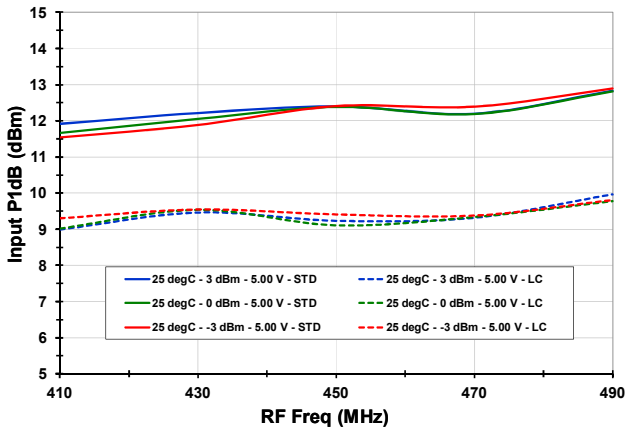

P1dB vs. LO Level (130 MHz IF)

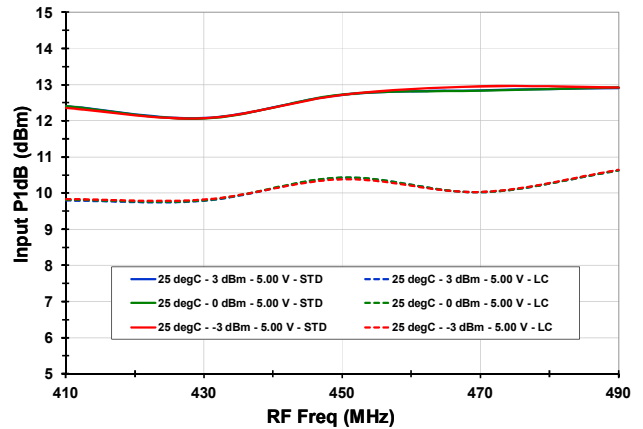

RF to IF Dual Downconverting Mixer

400 – 1000 MHz F1102NBGI

TYPICAL OPERATING CONDITIONS [400 MHz Bands see modifications on p. 25] (-11-)

2RF x 2LO vs. T_{CASE} (130 MHz IF)

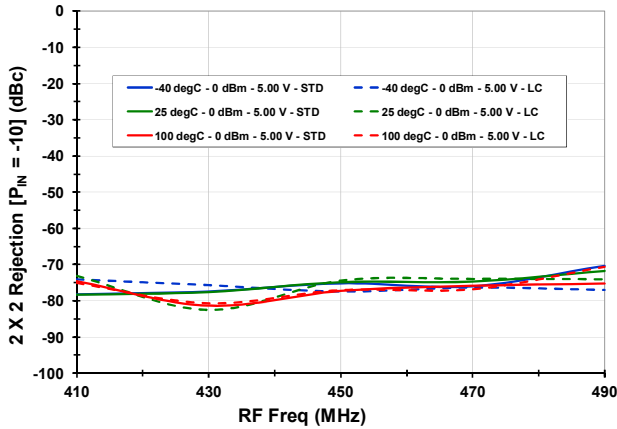

2RF x 2LO vs. LO Level (130 MHz IF)

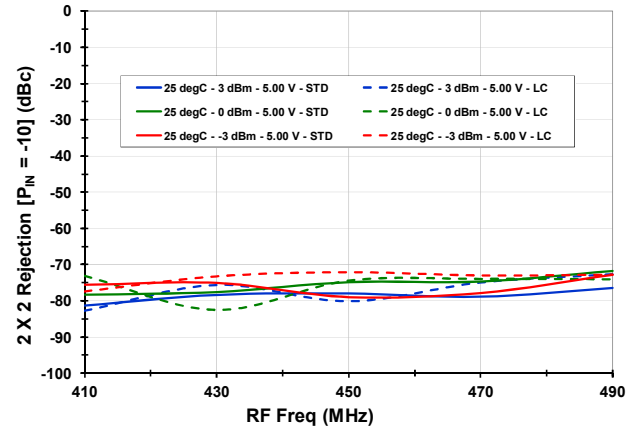

I_{CC} vs. T_{CASE} (130 MHz IF)

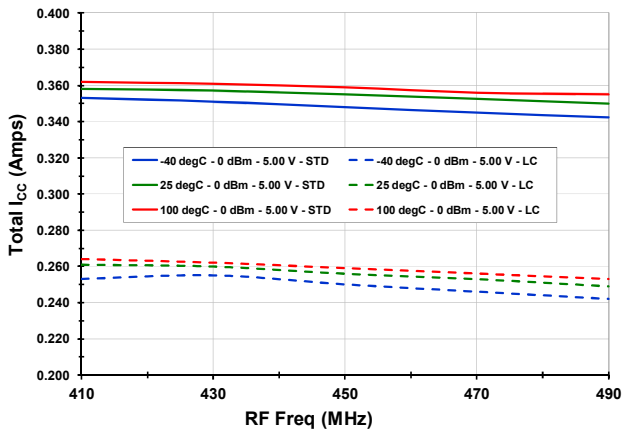

I_{CC} vs. LO Level (130 MHz IF)

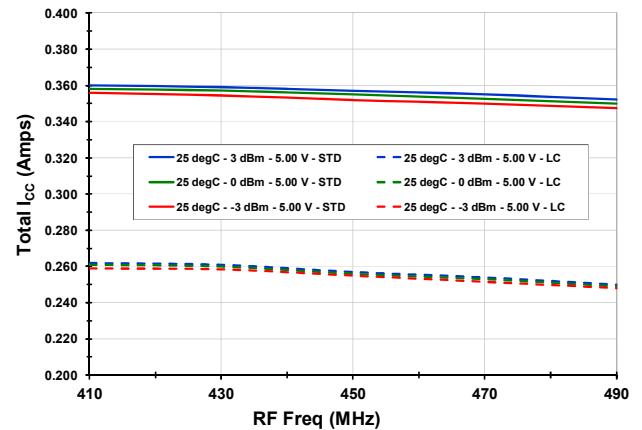

LO to IF Leakage vs. T_{CASE} (130 MHz IF)

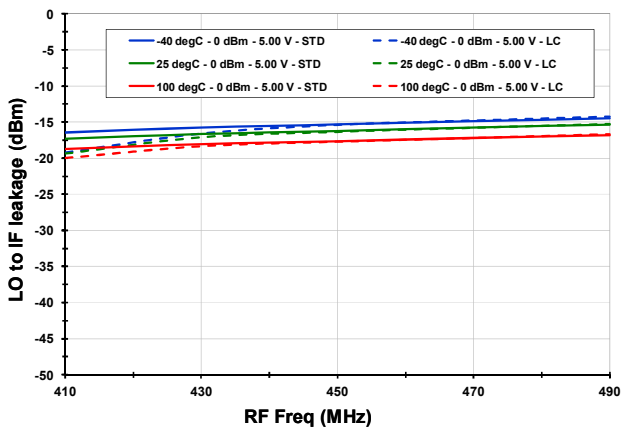

LO to IF Leakage vs. LO Level (130 MHz IF)

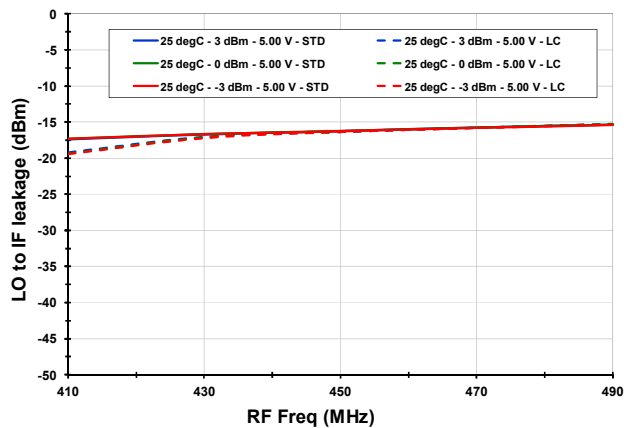

TYPICAL OPERATING CONDITIONS [400 MHz Bands see modifications on p. 25] (-12-)

RF to IF Leakage vs. T_{CASE} (130 MHz IF)

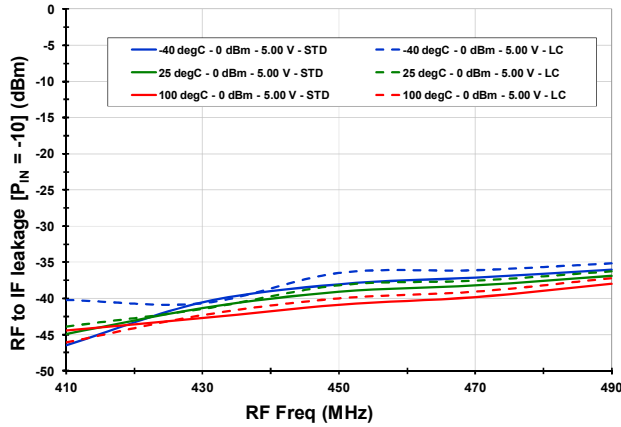

RF to IF Leakage vs. LO Level (130 MHz IF)

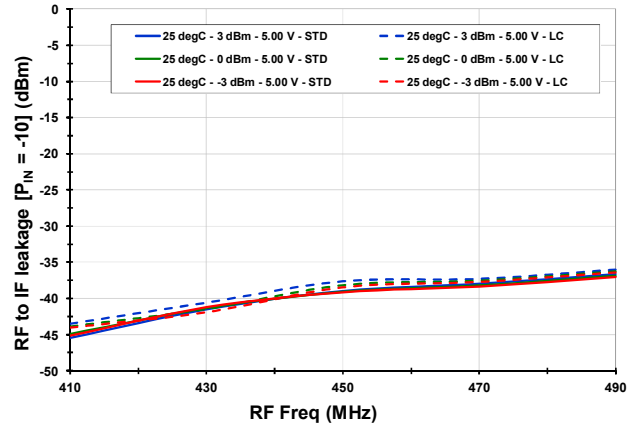

3RF x 3LO rejection vs. T_{CASE} (130 MHz IF)

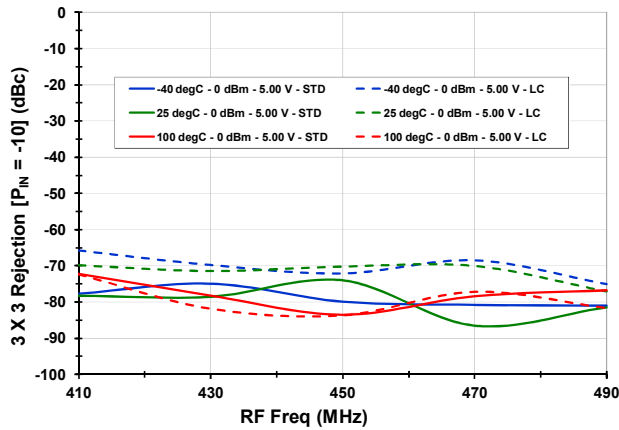

3RF x 3LO rejection vs. LO Level (130 MHz IF)

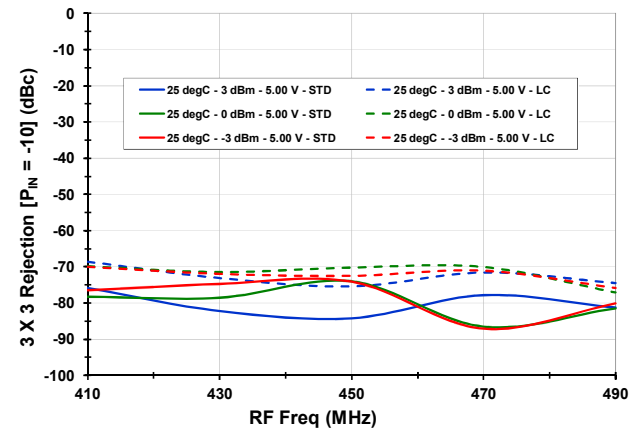

Channel Isolation vs. LO level (130 MHz IF)

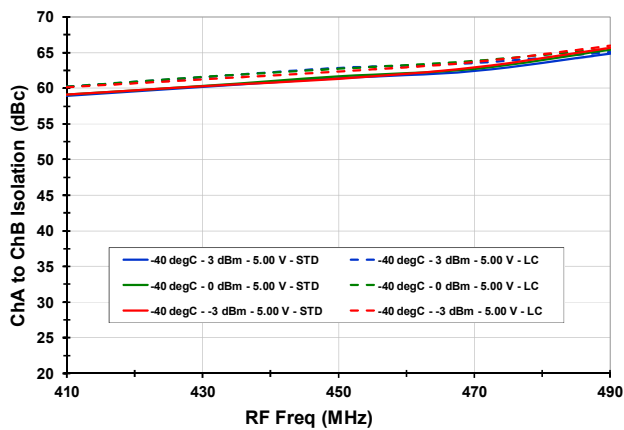

Noise Figure (T_{CASE} = 25C)

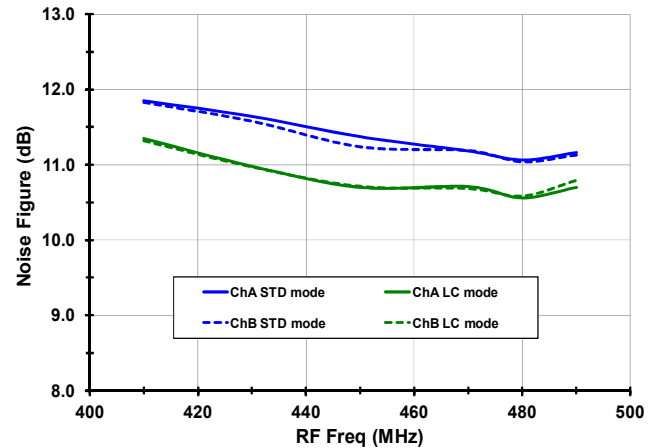

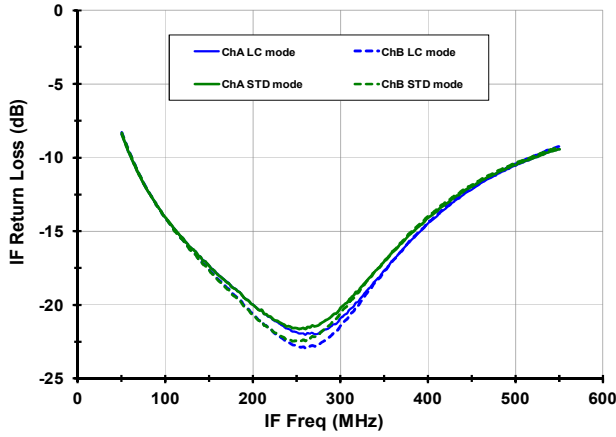
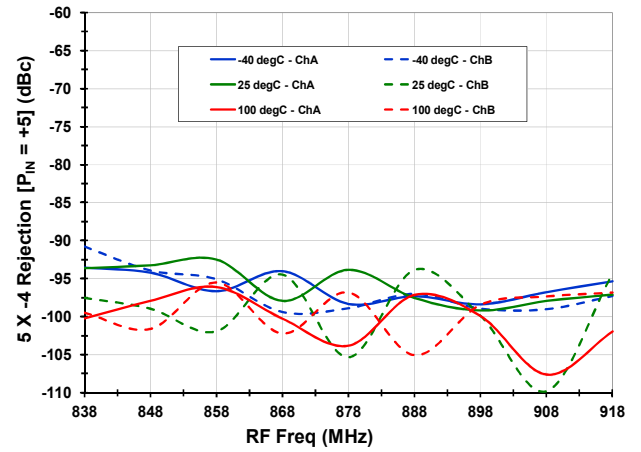
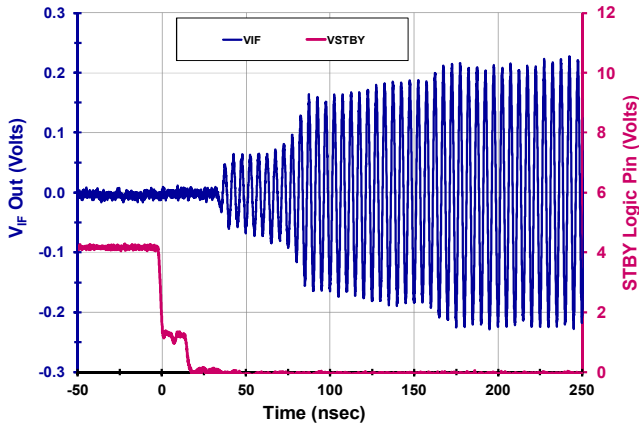
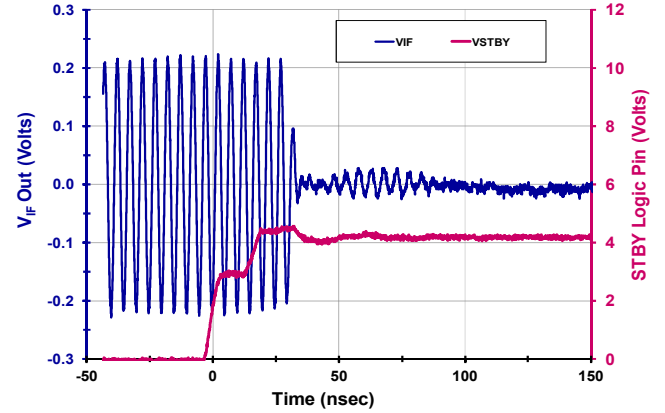
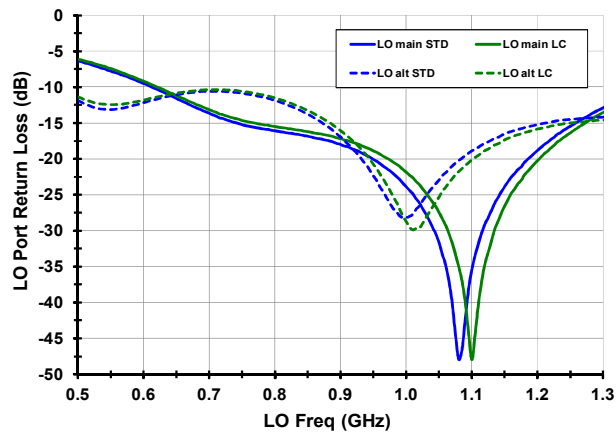
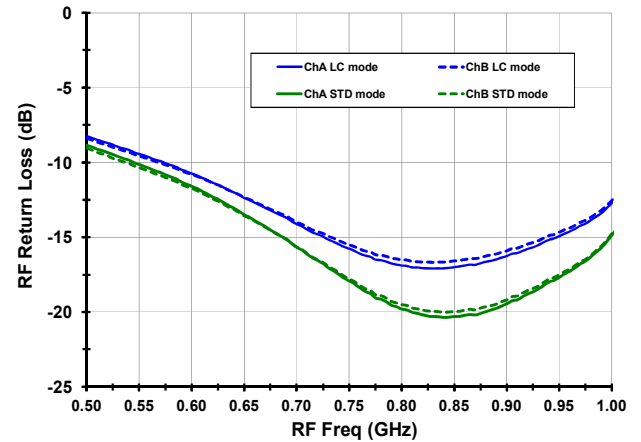
TYPICAL OPERATING CONDITIONS [General] (-13-)
EVkit IF Port Match ($T_A = 25C$)

SRF X -4LO Rejection (IF = 190M, STD Mode)

Settling Time (STBY -> V_{IL})

Settling Time (STBY -> V_{IH})

EVkit LO Port Match ($T_A = 25C, P_{MEAS} = 0 \text{ dBm}$)

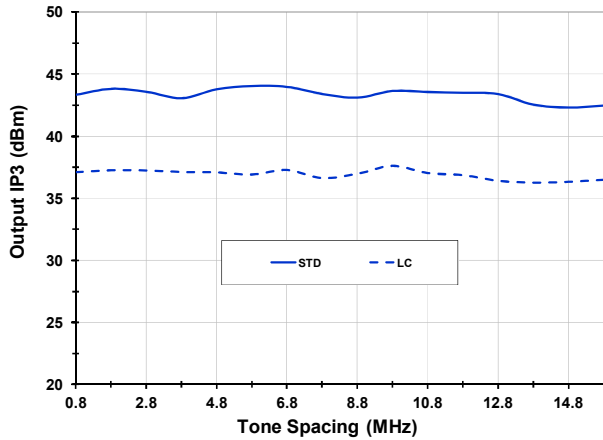
EVkit RF Port Match ($T_A = 25C$)

RF to IF Dual Downconverting Mixer

400 – 1000 MHz F1102NBGI

TYPICAL OPERATING CONDITIONS [General] (-14-)

IP3_O vs. Δf (T_A = 25C, Freq = 850 MHz, IF = 200 MHz)



IP3_O vs. P_{IN} (T_A = 25C, Freq = 850 MHz, IF = 200 MHz)

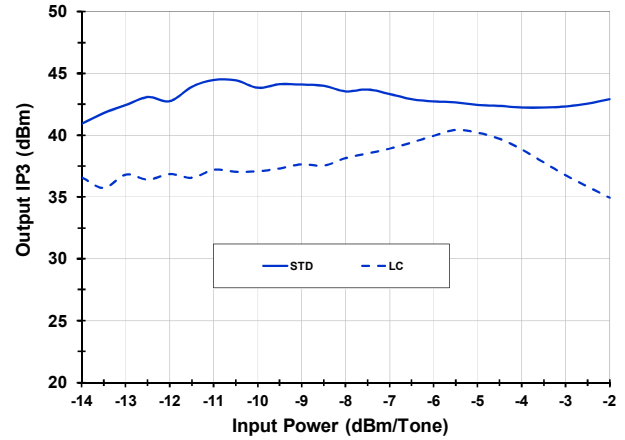

EVkit Input RF Trace Loss (T_A = 25C)

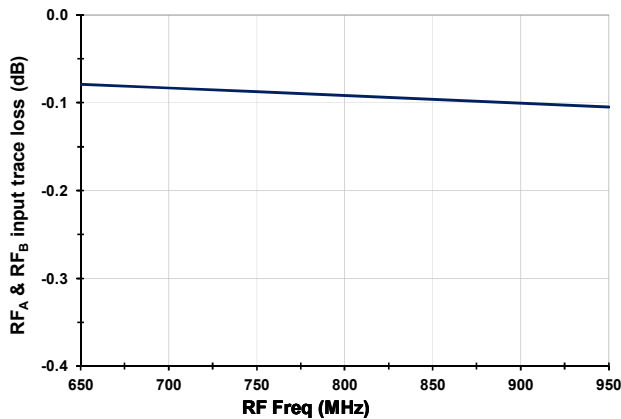

TC4-1T Transformer Loss

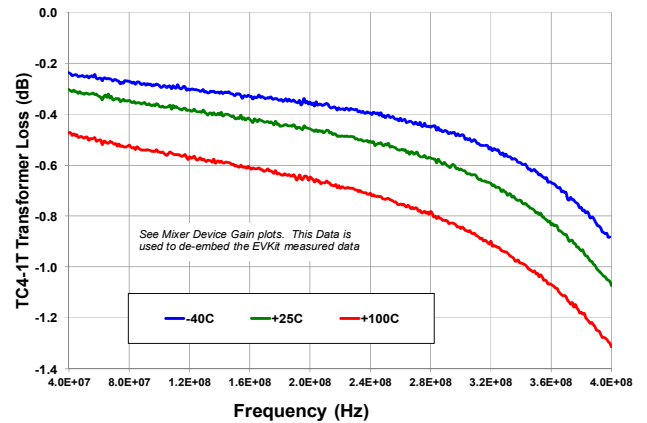

IP3_O Distribution (F_{RF} = 850 MHz, LC mode, N = 1598)

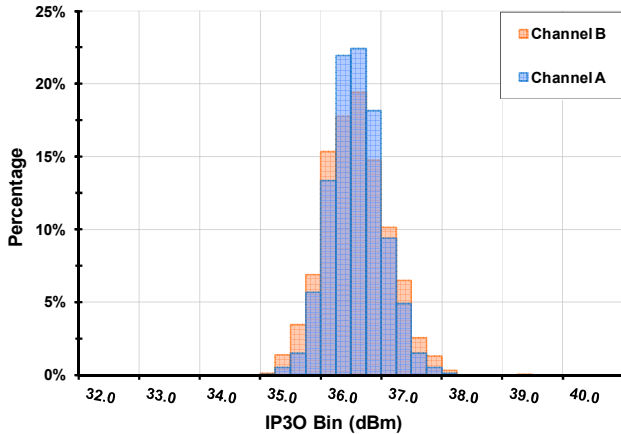

Gain Distribution (F_{RF} = 915 MHz, LC mode, N = 1598)

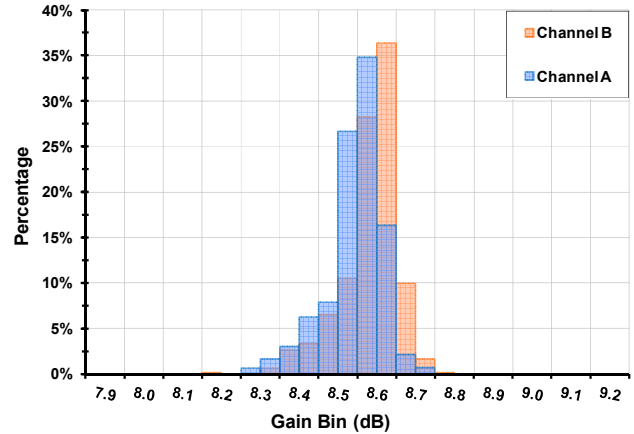

RF to IF Dual Downconverting Mixer

400 – 1000 MHz F1102NBGI

PACKAGE DRAWING (6X6 QFN)

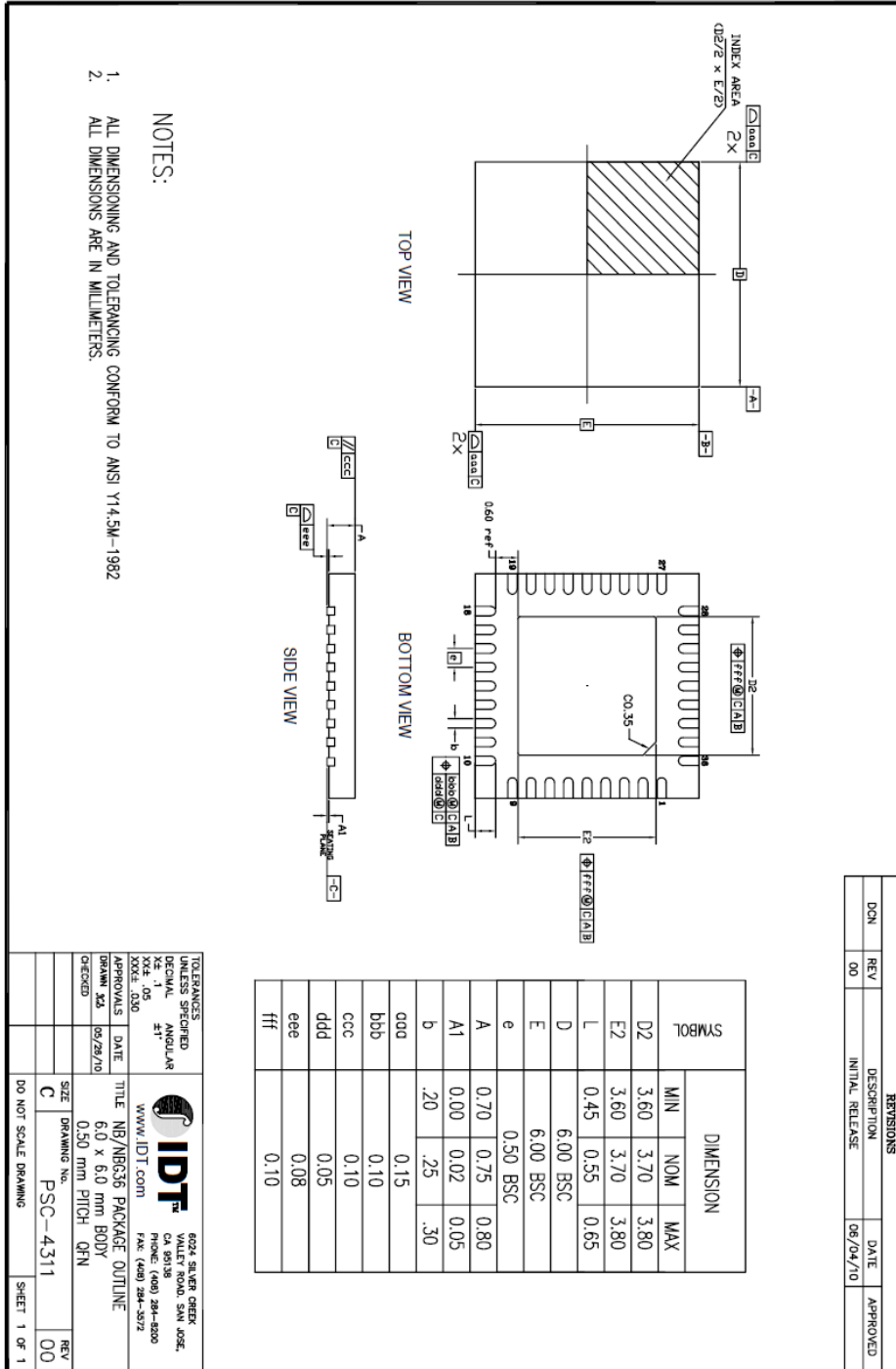

PINOUTS

Black Text denotes recommended external connection

Red Text denotes internal Function or Connection

- DB GND = Downbonded to Paddle
- Internal NC = Pin not connected

Please Note!

- Only connect to one LO feed
- Choose Either Pin 19 or Pin 27
- Do not connect the unused LO pin to ensure good LO return loss

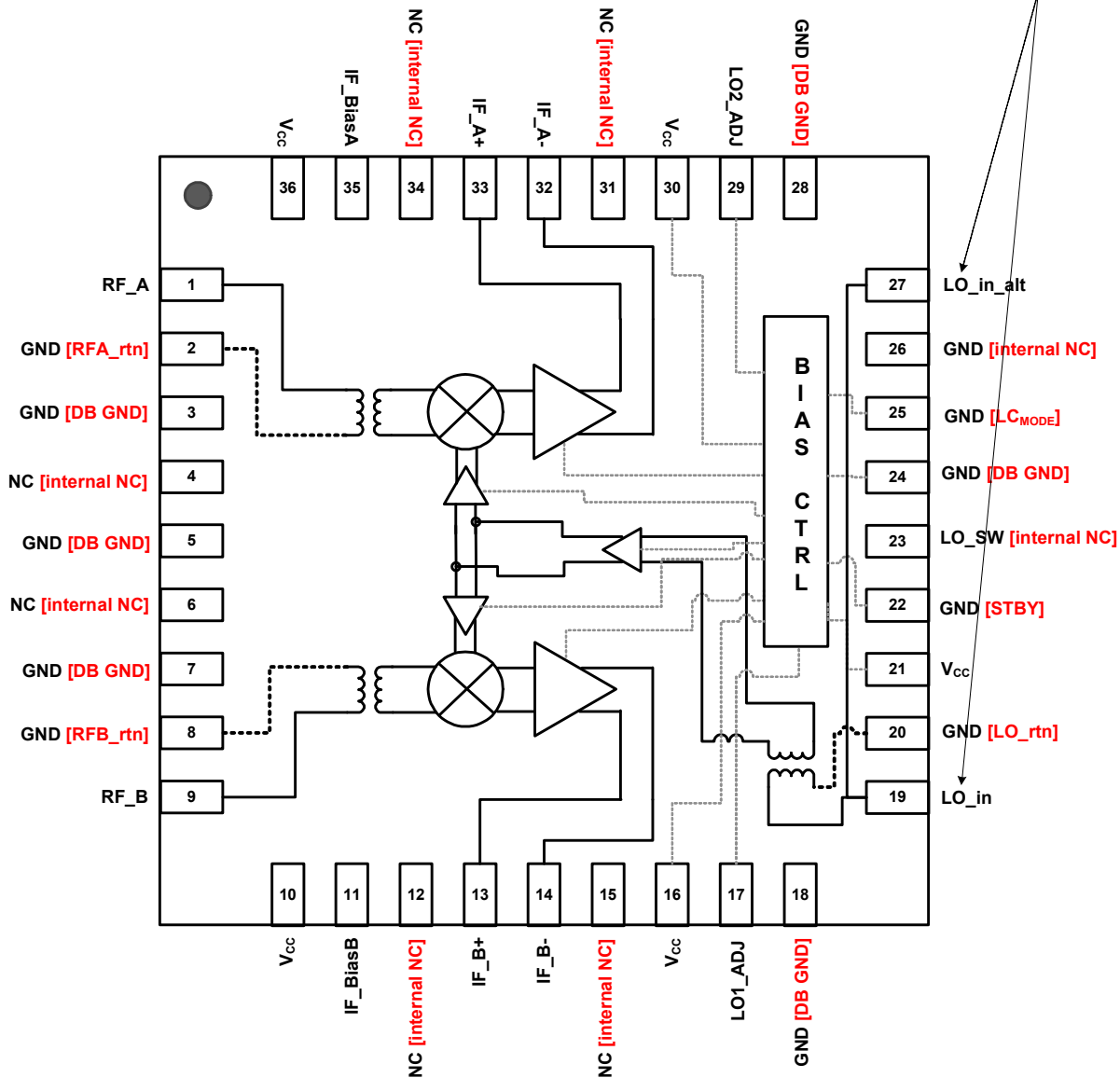

PIN DESCRIPTIONS

Pin	Name	Function
1	RF_A	Main Channel RF Input. Internally matched to 50Ω. DO NOT apply DC to these pins
2, 8, 20	RF_Artn, RF_Brtn, LO_rtn	Transformer Ground Returns. Ground these pins.
3, 5, 7, 18, 24, 28	GND	Ground these pins.
4, 6, 12, 15, 31, 23, 26, 34	N.C.	No Connection. Not internally connected. OK to connect to Vcc. OK to connect to GND
10, 16, 21, 30, 36	VCC	Power Supply. Bypass to GND with capacitors shown in the Typical Application Circuit as close as possible to pin.
9	RF_B	Diversity Channel RF Input. Internally matched to 50Ω
11	IF_BiasB	Connect the specified resistor from this pin to ground to set the bias for the Diversity IF amplifier. This is NOT a current set resistor
13, 14	IFB+, IFB-	Diversity Mixer Differential IF Output. Connect pullup inductors from each of these pins to VCC (see the Typical Application Circuit).
17	LO1_ADJ	Connect the specified resistor for either Standard or LC mode from this pin to ground to set the LO common buffer Icc
19, 27	LO_in LO_in_alt	Local Oscillator Input. Connect the LO to this port through the recommended coupling capacitor. Note that you can only drive one LO port at a time. Remove the series capacitor from the unused port.
25	LC_MODE	Low_Current Mode. Set this pin to low or ground for LC mode. Set to high or No-Connect for Standard mode. There is an internal pull-up resistor.
22	STBY	STBY Mode. Pull this pin high for Standby mode (~20 mA). Pull low or Ground for normal Operation
29	LO2_ADJ	Connect the specified resistor for either Standard or LC mode from this pin to ground to set the LO drive buffers Icc
32, 33	IFA-, IFA+	Main Mixer Differential IF Output. Connect pullup inductors from each of these pins to VCC (see the Typical Application Circuit).
35	IF_BiasA	Connect the specified resistor from this pin to ground to set the bias for the Main IF amplifier. This is NOT a current set resistor
	— EP	Exposed Pad. Internally connected to GND. Solder this exposed pad to a PCB pad that uses multiple ground vias to provide heat transfer out of the device into the PCB ground planes. These multiple via grounds are also required to achieve the noted RF performance.

EVKIT SCHEMATIC

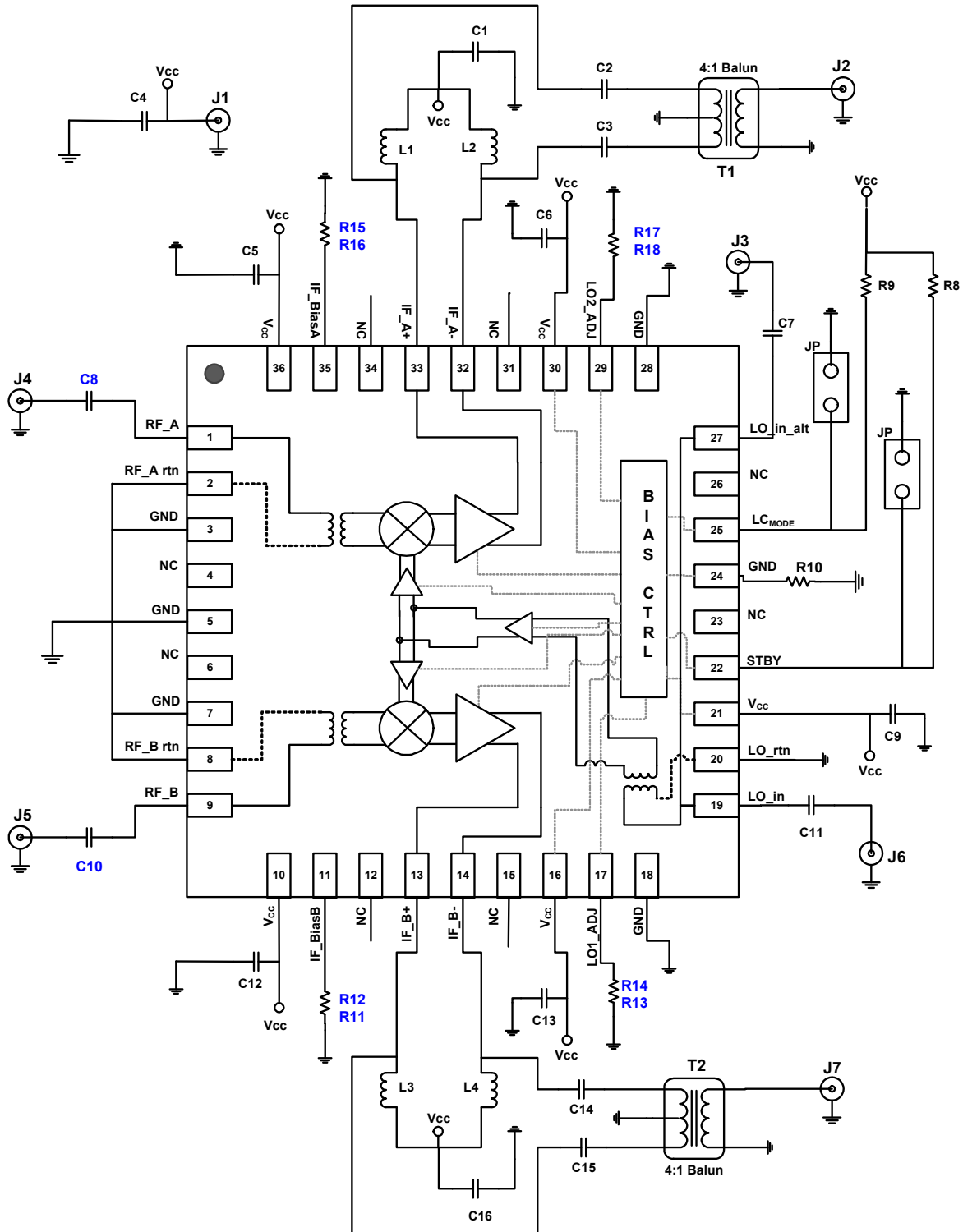

EVKIT PICTURE/LAYOUT/OPERATION

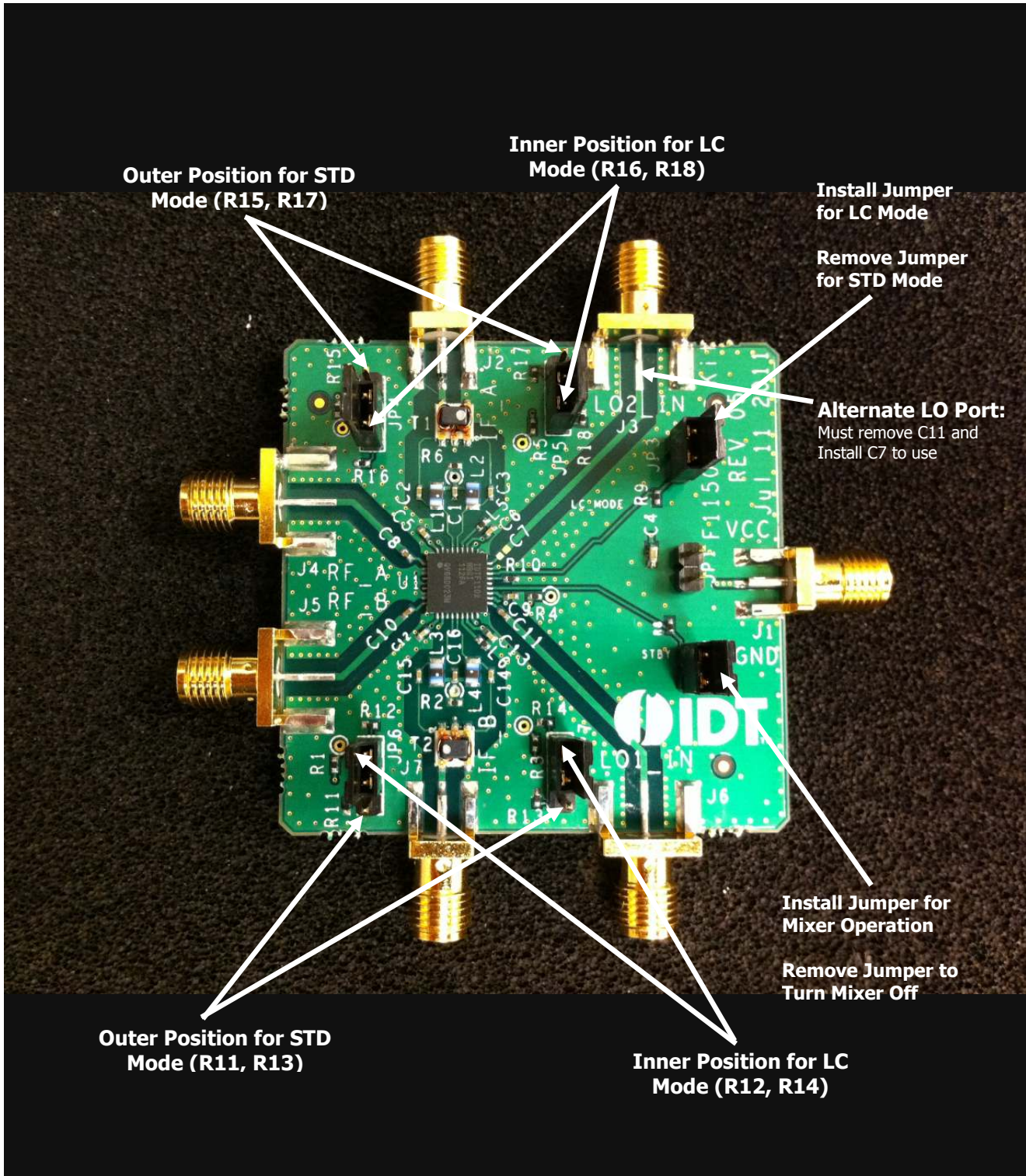

EVKIT BOM
Default BOM:

For Standard Mode, Open the LC_{MODE} jumper in conjunction with positioning the 4 dual jumpers to select the resistors in **red**.

For Low Current Mode close the LC_{MODE} jumper in conjunction with positioning the 4 dual jumpers to select the resistors in **blue**.

F1102 BOM

Item #	Value	Size	Desc	Mfr. Part #	Mfr.	Part Reference	Qty
1	10nF	0402	CAP CER 1000PF 16V 10% X7R 0402	GRM155R71C103KA01D	MURATA	C1,5,6,9,12,13,16	7
2	1000pF	0402	CAP CER 1000PF 50V C0G 0402	GRM1555C1H102JA01D	MURATA	C2,3,14,15	4
3	150pF	0402	CAP CER 150PF 50V C0G 0402	GRM1555C1H151JA01D	MURATA	C8,10,11	3
4	9 pF	0402	Note: C7 and C11 cannot be installed together. C7 for Pin27 LO feed. C11 for Pin19 LO feed			C7	1
5	10uF	0603	CAP CER 10UF 6.3V X5R 0603	GRM188R60J106ME47D	MURATA	C4	1
6	Header 2 Pin	TH 2	CONN HEADER VERT SGL 2POS GOLD	961102-6404-AR	3M	JP1,2,3	3
7	Header 3 Pin	TH 3	CONN HEADER VERT SGL 3POS GOLD	961103-6404-AR	3M	JP4,5,6,7	4
8	SMA_END_LAUNCH	.062	SMA_END_LAUNCH (Small)	142-0711-821	Emerson Johnson	J1,2,7	3
9	SMA_END_LAUNCH	.062	SMA_END_LAUNCH (Big)	142-0701-851	Emerson Johnson	J3,4,5,6	4
10	270nH	0805	0805CS (2012) Ceramic Chip Inductor	0805CS-271XJLB	COILCRAFT	L1,2,3,4	4
11	27	0402	RES 27 OHM 1/10W 1% 0402 SMD	ERJ-2RKF27R0X	Panasonic	R11,15	2
12	62	0402	RES 62.0 OHM 1/10W 1% 0402 SMD	ERJ-2RKF62R0X	Panasonic	R12,16	2
13	91	0402	RES 91.0 OHM 1/10W 1% 0402 SMD	ERJ-2RKF91R0X	Panasonic	R13	1
14	180	0402	RES 180 OHM 1/10W 1% 0402 SMD	ERJ-2RKF1800X	Panasonic	R14	1
15	1.91K	0402	RES 1.91K OHM 1/10W 1% 0402 SMD	ERJ-2RKF1911X	Panasonic	R18	1
16	1.21K	0402	RES 1.21K OHM 1/10W 1% 0402 SMD	ERJ-2RKF1211X	Panasonic	R17	1
17	47K	0402	RES 47.0K OHM 1/16W 1% 0402 SMD	RC0402FR-0747KLL	Yageo	R8,9	2
18	0	0402	RES 0.0 OHM 1/10W 0402 SMD	ERJ-2GE0R00X	Panasonic	R1,2,3,4,5,6,7,10	8
19	4:1 Balun	SM-22	4:1 Center Tap Balun	TC4-1TG2+	Mini Circuits	T1,2	2
20	F1102	QFN-36	Diversity Downconverter (400 - 1000 MHz)	F1102NBGI	IDT	U1	1
21	PCB		EV Kit	F1102 EVkit Rev5			1

Modified BOM and EVKit (for 400 MHz bands):

EVkit Modifications for High Side Injection 400 MHz operation (see TOCs on pages 15 – 17)

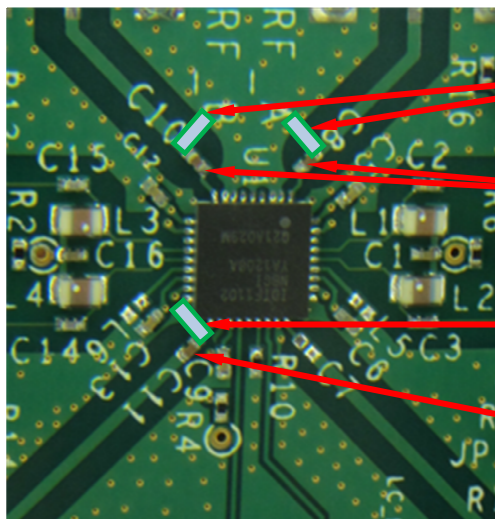

Scrape resist from ground and add shunt 8 pF

Replace C8 and C10 with 18 pF

Scrape resist from ground and add shunt 1.8 pF

Replace C11 with 6.8 pF

RF to IF Dual Downconverting Mixer

400 – 1000 MHz F1102NBGI

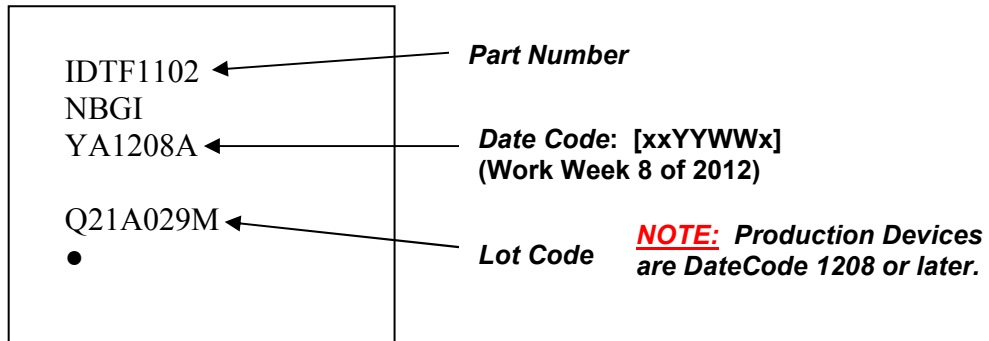
TOPMARKINGS

IMPORTANT NOTICE AND DISCLAIMER

RENESAS ELECTRONICS CORPORATION AND ITS SUBSIDIARIES (“RENESAS”) PROVIDES TECHNICAL SPECIFICATIONS AND RELIABILITY DATA (INCLUDING DATASHEETS), DESIGN RESOURCES (INCLUDING REFERENCE DESIGNS), APPLICATION OR OTHER DESIGN ADVICE, WEB TOOLS, SAFETY INFORMATION, AND OTHER RESOURCES “AS IS” AND WITH ALL FAULTS, AND DISCLAIMS ALL WARRANTIES, EXPRESS OR IMPLIED, INCLUDING, WITHOUT LIMITATION, ANY IMPLIED WARRANTIES OF MERCHANTABILITY, FITNESS FOR A PARTICULAR PURPOSE, OR NON-INFRINGEMENT OF THIRD PARTY INTELLECTUAL PROPERTY RIGHTS.

These resources are intended for developers skilled in the art designing with Renesas products. You are solely responsible for (1) selecting the appropriate products for your application, (2) designing, validating, and testing your application, and (3) ensuring your application meets applicable standards, and any other safety, security, or other requirements. These resources are subject to change without notice. Renesas grants you permission to use these resources only for development of an application that uses Renesas products. Other reproduction or use of these resources is strictly prohibited. No license is granted to any other Renesas intellectual property or to any third party intellectual property. Renesas disclaims responsibility for, and you will fully indemnify Renesas and its representatives against, any claims, damages, costs, losses, or liabilities arising out of your use of these resources. Renesas' products are provided only subject to Renesas' Terms and Conditions of Sale or other applicable terms agreed to in writing. No use of any Renesas resources expands or otherwise alters any applicable warranties or warranty disclaimers for these products.

(Rev.1.0 Mar 2020)

Corporate Headquarters

TOYOSU FORESIA, 3-2-24 Toyosu,
Koto-ku, Tokyo 135-0061, Japan
www.renesas.com

Contact Information

For further information on a product, technology, the most up-to-date version of a document, or your nearest sales office, please visit:
www.renesas.com/contact/

Trademarks

Renesas and the Renesas logo are trademarks of Renesas Electronics Corporation. All trademarks and registered trademarks are the property of their respective owners.