

## SINGLE SUPPLY QUAD OPERATIONAL AMPLIFIER

### ■ GENERAL DESCRIPTION

The NJM13403 is single-supply quad operational amplifier, which can operate from 2V supply. The features are low offset voltage, low bias current, high slew-rate, and free crossover distortion through the AB class output stage.

The package lineup is DIP, DMP and others compact, so that the NJM13403 is suitable for audio for low voltage operation and any other kind of signal amplifier.

### ■ FEATURES

- Operating Voltage ( +2V~+14V )
- Slew Rate ( 1.2V/μs typ. )
- Operating Current ( 3.0mA typ. )
- Bipolar Technology
- Package Outline DIP14,DMP14,SSOP14

### ■ PACKAGE OUTLINE

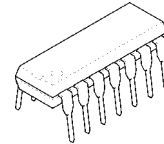

NJM13403D1

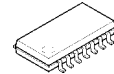

NJM13403M



NJM13403V

### ■ PIN CONFIGURATION

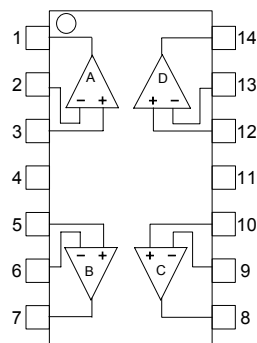

NJM13403D1, NJM13403M  
NJM13403V

#### PIN FUNCTION

- |                  |             |
|------------------|-------------|
| 1.A OUTPUT       | 8.C OUTPUT  |
| 2.A -INPUT       | 9.C -INPUT  |
| 3.A +INPUT       | 10.C +INPUT |
| 4.V <sup>+</sup> | 11.GND      |
| 5.B +INPUT       | 12.D +INPUT |
| 6.B -INPUT       | 13.D -INPUT |
| 7.B OUTPUT       | 14.D OUTPUT |

### ■ EQUIVALENT CIRCUIT ( 1/4 Shown )

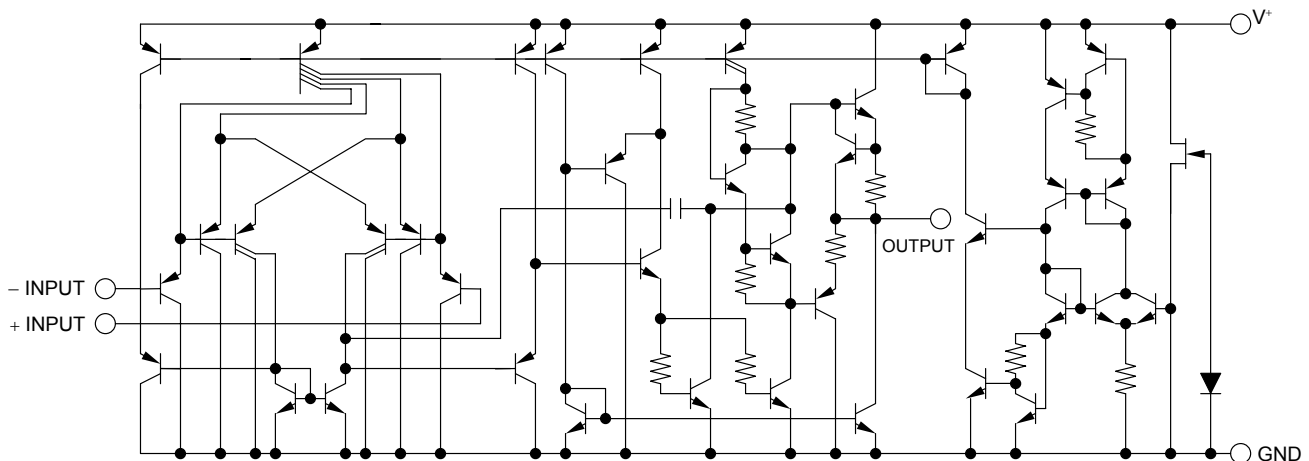

# NJM13403

## ■ ABSOLUTE MAXIMUM RATINGS

( Ta=25°C )

PARAMETER	SYMBOL	RATINGS	UNIT
Supply Voltage	$V^+$	15	V
Differential Input Voltage	$V_{ID}$	14	V
Input Voltage	$V_{IC}$	-0.3~+14	V
Power Dissipation	$P_D$	( DIP14 ) 700 ( DMP14 ) 300 ( SSOP14 ) 300	mW
Operating Temperature Range	$T_{opr}$	-40~+85	°C
Storage Temperature Range	$T_{stg}$	-40~+125	°C

## ■ ELECTRICAL CHARACTERISTICS

(  $V^+=5V, Ta=25°C$  )

PARAMETER	SYMBOL	TEST CONDITION	MIN.	TYP.	MAX.	UNIT
Operating Voltage	$V_{opr}$		2	-	14	V
Input Offset Voltage	$V_{IO}$	$R_S=0\Omega$	-	0.5	4	mV
Input Offset Current	$I_{IO}$		-	5	50	nA
Input Bias Current	$I_B$		-	25	150	nA
Large Signal Voltage Gain	$A_V$	$R_L \geq 2k\Omega$	88	100	-	dB
Maximum Output Voltage Swing	$V_{OM}$	$R_L=2k\Omega$	4.0	4.2	-	V
Input Common Mode Voltage Range	$V_{ICM}$		0~3.5	-	-	V
Common Mode Rejection Ratio	CMR		70	90	-	dB
Supply Voltage Rejection Ratio	SVR		80	94	-	dB
Output Source Current	$I_{SOURCE}$	$V_{IN}^+=1V, V_{IN}^-=0V$	20	35	-	mA
Output Sink Current	$I_{SINK}$	$V_{IN}^+=0V, V_{IN}^-=1V$	10	30	-	mA
Operating Current	$I_{CC}$	$R_L=\infty$	-	3.0	5.0	mA
Slew Rate	SR	$V^+V^-=\pm 2.5V, R_L=2k\Omega,$ $A_V=0dB, f=1kHz$	-	1.2	-	V/ $\mu$ s
Unity Gain Bandwidth	$f_T$	$R_L=2k\Omega$	-	2.0	-	MHz
Total Harmonic Distortion	THD	$R_L=2k\Omega, A_V=40dB,$ $f=20kHz, V_O=1.0V_{rms}$	-	0.2	-	%

## ■ TYPICAL CHARACTERISTICS

Operating Current vs. Operating Voltage  
( $T_a=25^\circ\text{C}$ )

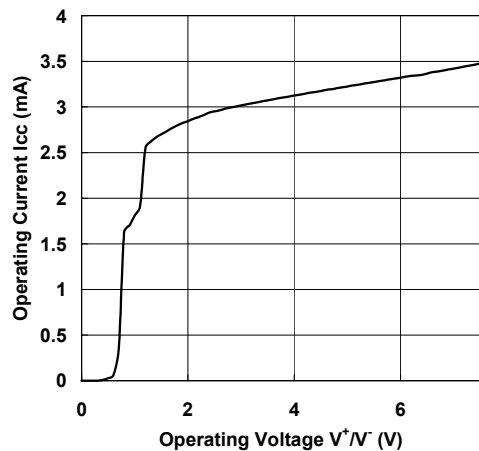

Input Offset Voltage vs. Operating Voltage  
( $T_a=25^\circ\text{C}$ )

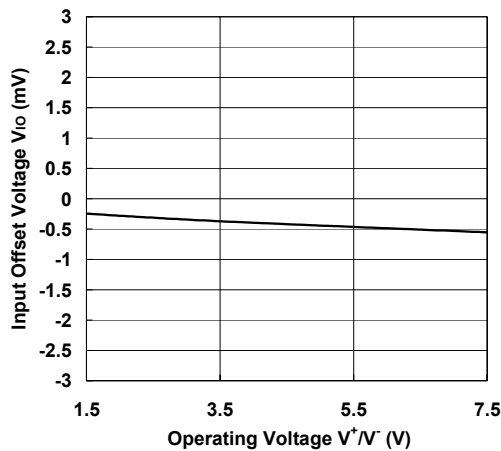

Input Bias Current vs. Operating Voltage  
( $T_a=25^\circ\text{C}$ )

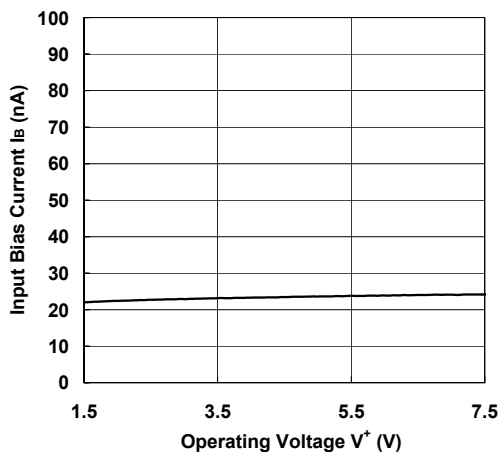

Maximum Output Voltage Swing vs. Operating Voltage  
( $T_a=25^\circ\text{C}$ )

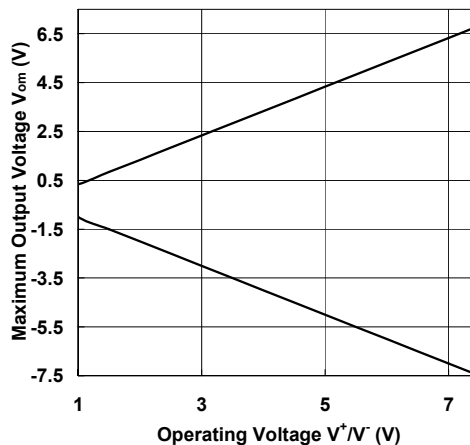

Input Common Mode Voltage Range  
( $V^+=5\text{V}$ ,  $T_a=25^\circ\text{C}$ )

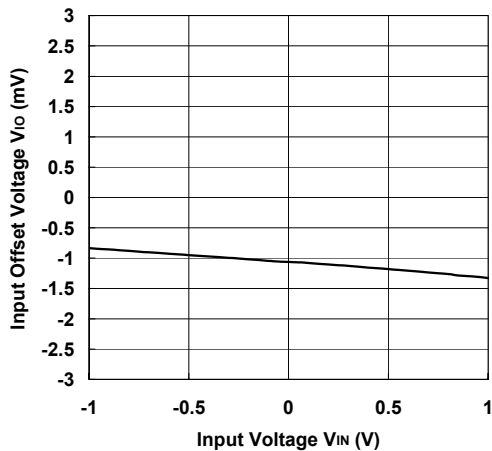

Large Signal Voltage Gain vs. Operating Voltage  
( $T_a=25^\circ\text{C}$ ,  $R_L=2\text{k}\Omega$ )

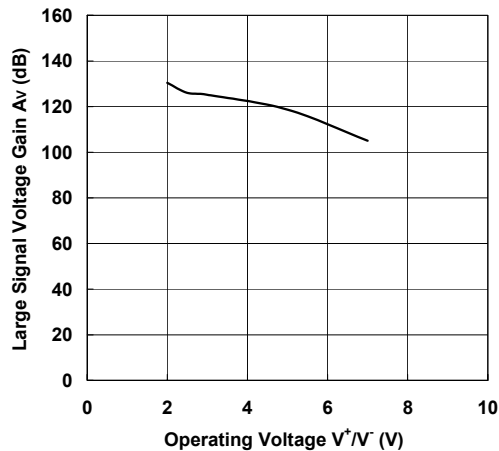

## ■ TYPICAL CHARACTERISTICS

Maximum Output Voltage vs. Frequency  
( $T_a=25^\circ\text{C}$ )

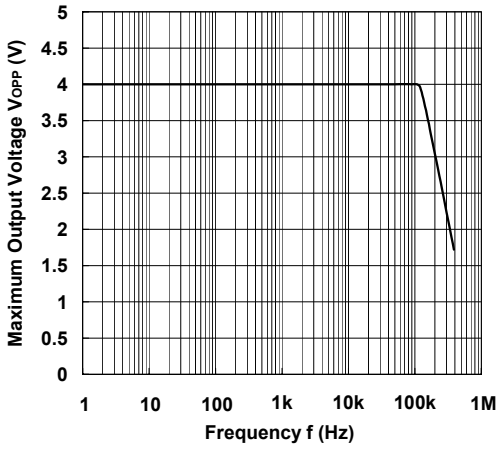

Gain/Phase vs. Frequency  
( $T_a=25^\circ\text{C}$ )

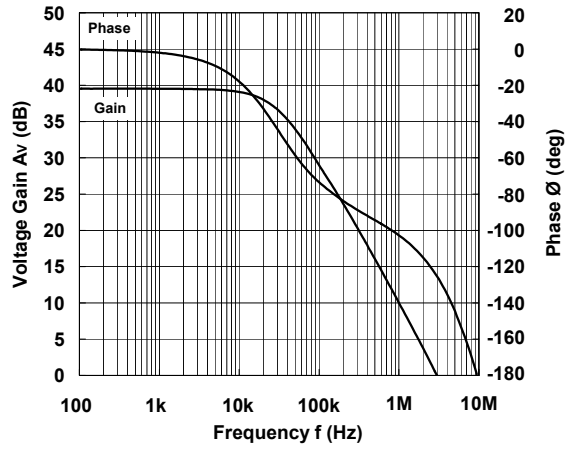

Output Voltage vs. Output Sink Current  
( $T_a=25^\circ\text{C}$ )

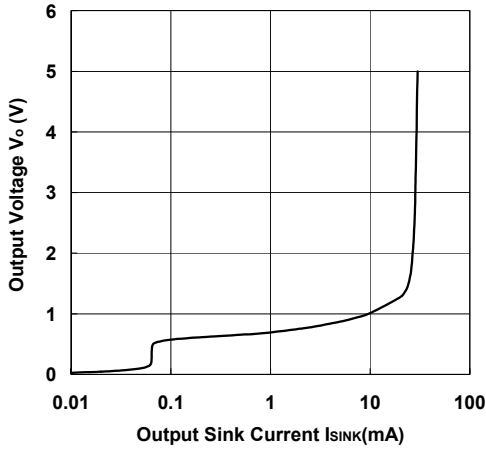

Output Voltage vs. Output Source Current  
( $T_a=25^\circ\text{C}$ )

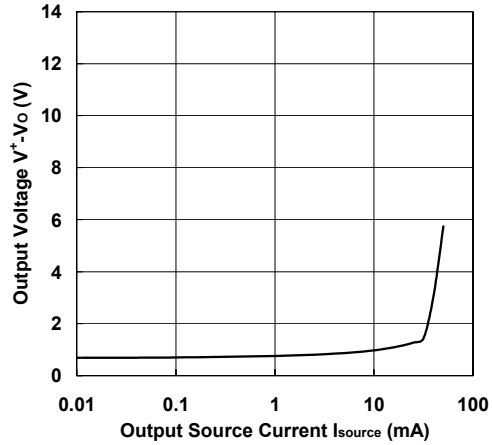

Slew Rate (Rise)

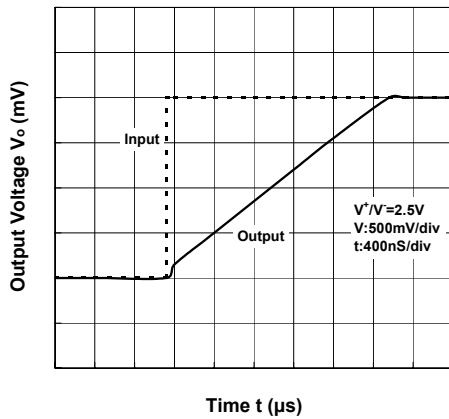

Slew Rate (Fall)

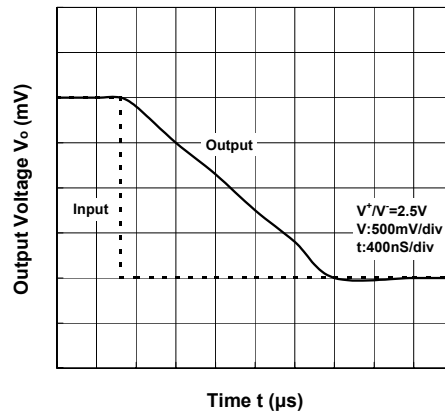

## ■ TYPICAL CHARACTERISTICS

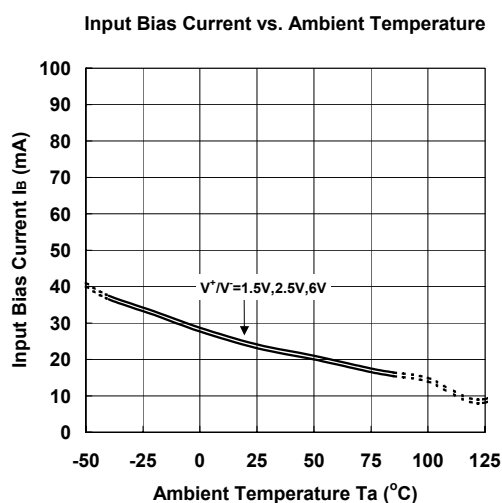
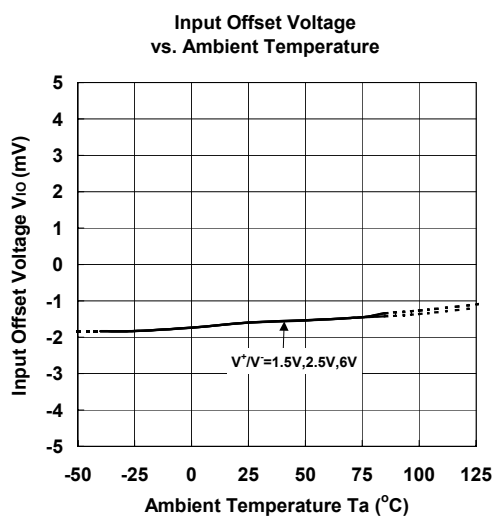
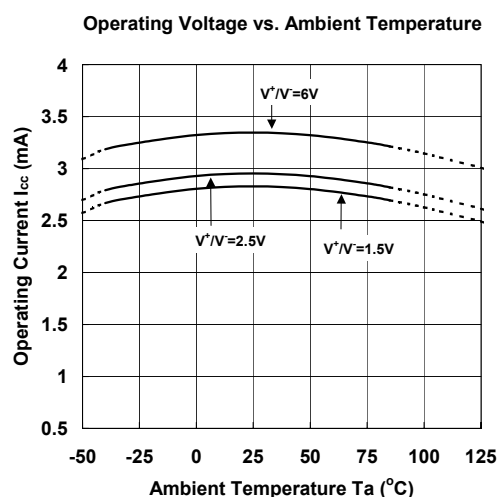
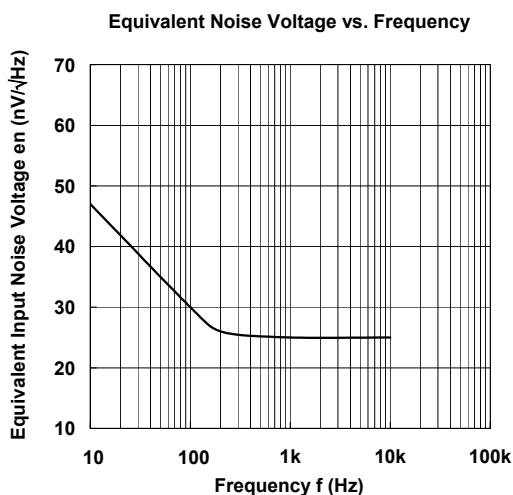
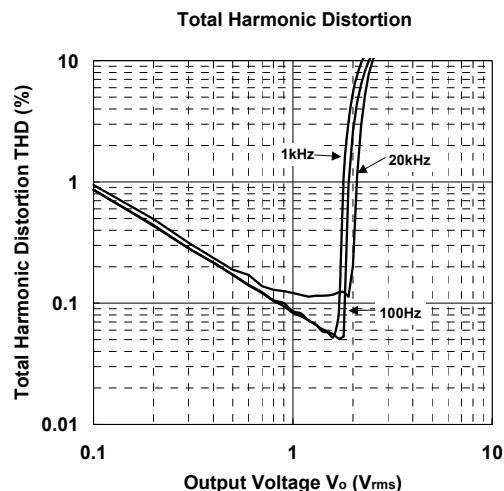
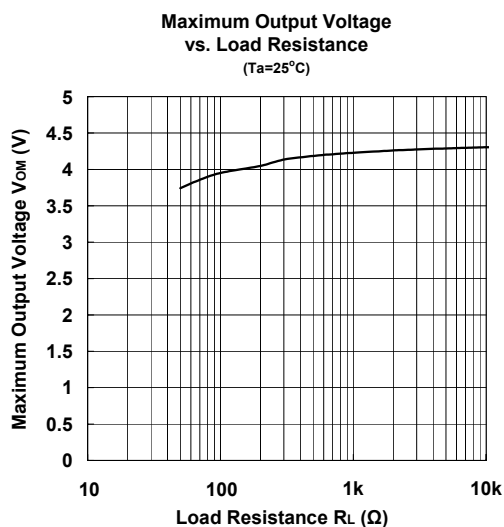

## ■ TYPICAL CHARACTERISTICS

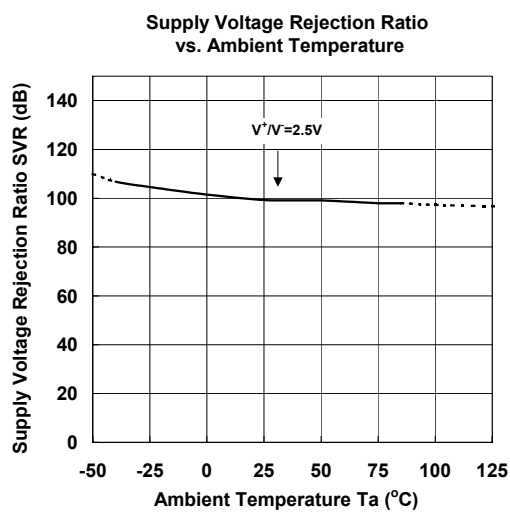
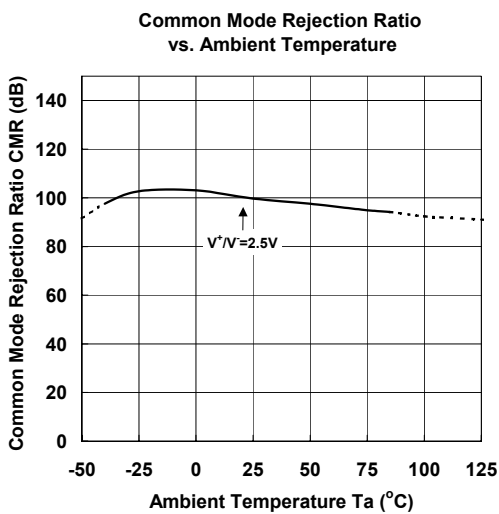
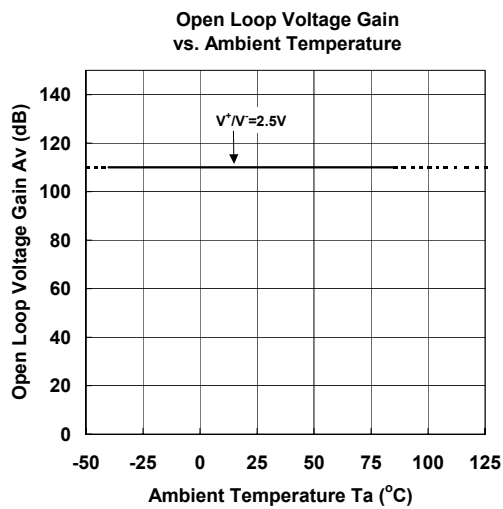
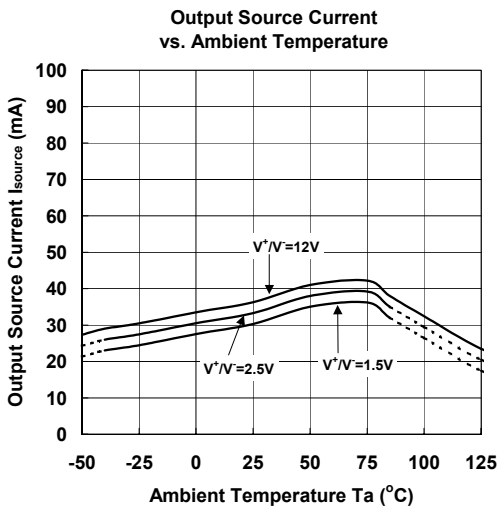
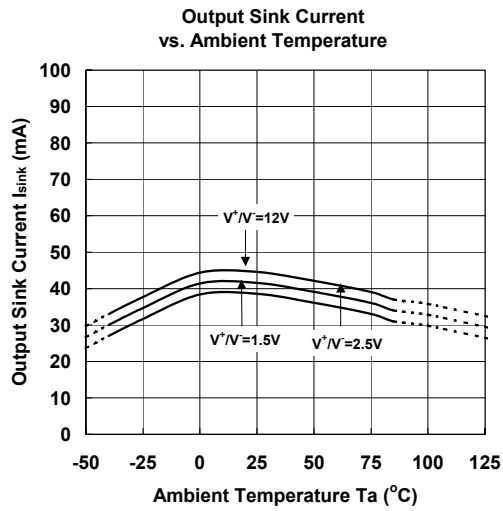
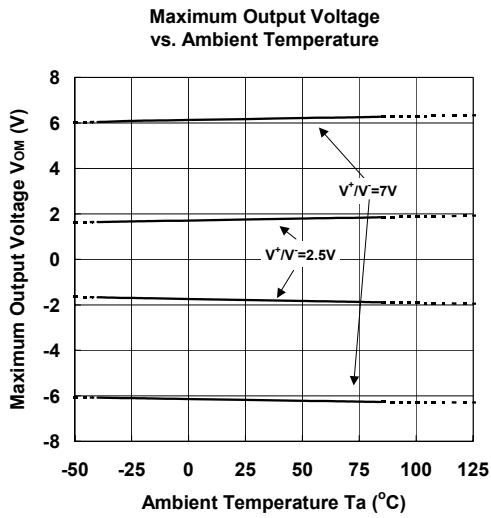

**[CAUTION]**

The specifications on this data book are only given for information, without any guarantee as regards either mistakes or omissions. The application circuits in this data book are described only to show representative usages of the product and not intended for the guarantee or permission of any right including the industrial rights.