



Designers' Choice

AUDIO JACKS & "F" CONNECTORS

SURFACE MOUNT STEREO JACKS

- Mates with 2.5mm and 3.5mm plugs
- Designed for reliable interface with audio equipment including computer speakers, headphones, sound cards, cell phones, etc.
- Models available for mono and stereo applications
- Low profile, surface mount design

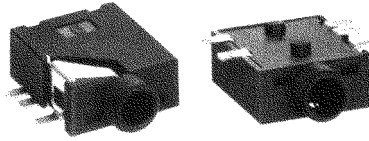

SPECIFICATIONS

Housing: Polyamide, Rated UL 94V-0
Ground Terminal: .012 Brass, Gold Flash ①
Spring Contacts: .008 Phosphor Bronze, Gold Flash ② ⑤
Shunt Terminals: .012 Brass, Gold flash ③ ④

FOR 2.5mm PLUGS

Supplied on Tape and Reel

FOR 3.5mm PLUGS

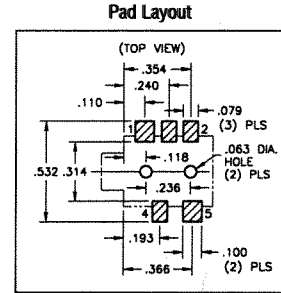
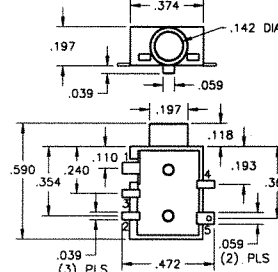
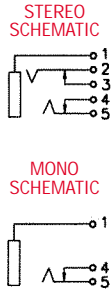
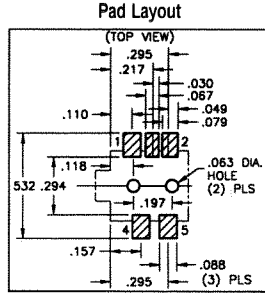
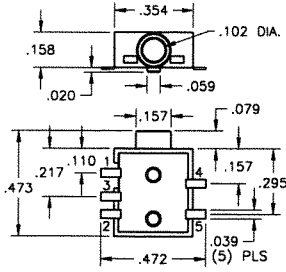

CAT. NO. 980TR (Stereo) Tape Spec's: 24mm wide; 16mm pitch
 CAT. NO. 982TR (Mono) Reel Spec's: 15 inch reel (1,000 pieces per reel)

CAT. NO. 981TR (Stereo) Tape Spec's: 24mm wide; 16mm pitch
 CAT. NO. 983TR (Mono) Reel Spec's: 15 inch reel (800 pieces per reel)

COLOR KEYED — PC PHONO JACKS

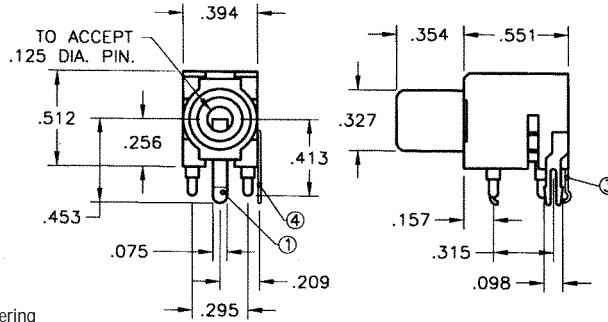
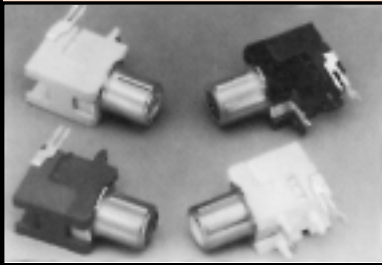

- Mates with .125 diameter pins
- Features a normally closed circuit
- Various colors for circuit identification
- Snap-fit mounting for positive retention during wave soldering

CAT. NO.	COLOR
970	WHITE
971	RED
972	BLACK
973	YELLOW

SPECIFICATIONS

Housing: PBT
Ground Terminal: .020 Brass, Nickel Plate ①
Spring Contact: .012 Phosphor Bronze, Silver Plate ③
Shunt Terminal: .016 Brass, Silver Plate ④

Mounting Detail

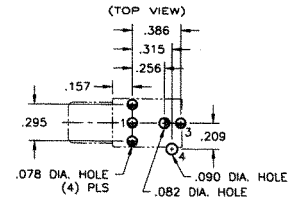

"F" FEMALE CONNECTORS

SNAP-FIT PC MOUNT

- Low profile
- Snap-fit mounting for positive retention during wave soldering
- Rugged, stable construction facilitates reliable mating
- High reliability, manufactured using Nickel Plated Brass bodies and Tin Plated Phosphor Bronze contacts
- Supplied with washer and nut

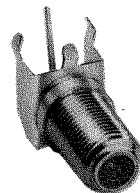
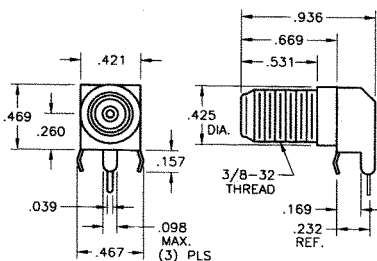

Mounting Detail

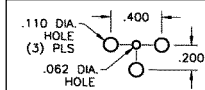

CAT. NO. 911

PANEL MOUNT

- Anti-rotation design
- Rugged construction facilitates reliable mating
- High reliability, manufactured using Nickel Plated Brass bodies and Tin Plated Phosphor Bronze contacts
- Supplied with washer and nut

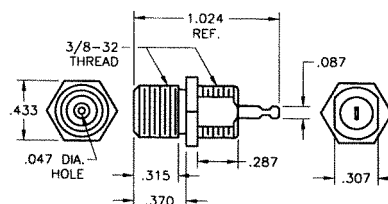

Mounting Detail

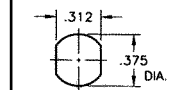

CAT. NO. 912