

DAC1220EVM

Evaluation Module

User's Guide

IMPORTANT NOTICE

Texas Instruments Incorporated and its subsidiaries (TI) reserve the right to make corrections, modifications, enhancements, improvements, and other changes to its products and services at any time and to discontinue any product or service without notice. Customers should obtain the latest relevant information before placing orders and should verify that such information is current and complete. All products are sold subject to TI's terms and conditions of sale supplied at the time of order acknowledgment.

TI warrants performance of its hardware products to the specifications applicable at the time of sale in accordance with TI's standard warranty. Testing and other quality control techniques are used to the extent TI deems necessary to support this warranty. Except where mandated by government requirements, testing of all parameters of each product is not necessarily performed.

TI assumes no liability for applications assistance or customer product design. Customers are responsible for their products and applications using TI components. To minimize the risks associated with customer products and applications, customers should provide adequate design and operating safeguards.

TI does not warrant or represent that any license, either express or implied, is granted under any TI patent right, copyright, mask work right, or other TI intellectual property right relating to any combination, machine, or process in which TI products or services are used. Information published by TI regarding third-party products or services does not constitute a license from TI to use such products or services or a warranty or endorsement thereof. Use of such information may require a license from a third party under the patents or other intellectual property of the third party, or a license from TI under the patents or other intellectual property of TI.

Reproduction of information in TI data books or data sheets is permissible only if reproduction is without alteration and is accompanied by all associated warranties, conditions, limitations, and notices. Reproduction of this information with alteration is an unfair and deceptive business practice. TI is not responsible or liable for such altered documentation.

Resale of TI products or services with statements different from or beyond the parameters stated by TI for that product or service voids all express and any implied warranties for the associated TI product or service and is an unfair and deceptive business practice. TI is not responsible or liable for any such statements.

Following are URLs where you can obtain information on other Texas Instruments products and application solutions:

Products		Applications	
Amplifiers	amplifier.ti.com	Audio	www.ti.com/audio
Data Converters	dataconverter.ti.com	Automotive	www.ti.com/automotive
DSP	dsp.ti.com	Broadband	www.ti.com/broadband
Interface	interface.ti.com	Digital Control	www.ti.com/digitalcontrol
Logic	logic.ti.com	Military	www.ti.com/military
Power Mgmt	power.ti.com	Optical Networking	www.ti.com/opticalnetwork
Microcontrollers	microcontroller.ti.com	Security	www.ti.com/security
		Telephony	www.ti.com/telephony
		Video & Imaging	www.ti.com/video
		Wireless	www.ti.com/wireless

Mailing Address: Texas Instruments
Post Office Box 655303 Dallas, Texas 75265

Copyright © 2004, Texas Instruments Incorporated

EVM IMPORTANT NOTICE

Texas Instruments (TI) provides the enclosed product(s) under the following conditions:

This evaluation kit being sold by TI is intended for use for **ENGINEERING DEVELOPMENT OR EVALUATION PURPOSES ONLY** and is not considered by TI to be fit for commercial use. As such, the goods being provided may not be complete in terms of required design-, marketing-, and/or manufacturing-related protective considerations, including product safety measures typically found in the end product incorporating the goods. As a prototype, this product does not fall within the scope of the European Union directive on electromagnetic compatibility and therefore may not meet the technical requirements of the directive.

Should this evaluation kit not meet the specifications indicated in the EVM User's Guide, the kit may be returned within 30 days from the date of delivery for a full refund. **THE FOREGOING WARRANTY IS THE EXCLUSIVE WARRANTY MADE BY SELLER TO BUYER AND IS IN LIEU OF ALL OTHER WARRANTIES, EXPRESSED, IMPLIED, OR STATUTORY, INCLUDING ANY WARRANTY OF MERCHANTABILITY OR FITNESS FOR ANY PARTICULAR PURPOSE.**

The user assumes all responsibility and liability for proper and safe handling of the goods. Further, the user indemnifies TI from all claims arising from the handling or use of the goods. Please be aware that the products received may not be regulatory compliant or agency certified (FCC, UL, CE, etc.). Due to the open construction of the product, it is the user's responsibility to take any and all appropriate precautions with regard to electrostatic discharge.

EXCEPT TO THE EXTENT OF THE INDEMNITY SET FORTH ABOVE, NEITHER PARTY SHALL BE LIABLE TO THE OTHER FOR ANY INDIRECT, SPECIAL, INCIDENTAL, OR CONSEQUENTIAL DAMAGES.

TI currently deals with a variety of customers for products, and therefore our arrangement with the user **is not exclusive**.

TI assumes **no liability for applications assistance, customer product design, software performance, or infringement of patents or services described herein**.

Please read the EVM User's Guide and, specifically, the EVM Warnings and Restrictions notice in the EVM User's Guide prior to handling the product. This notice contains important safety information about temperatures and voltages. For further safety concerns, please contact the TI application engineer.

Persons handling the product must have electronics training and observe good laboratory practice standards.

No license is granted under any patent right or other intellectual property right of TI covering or relating to any machine, process, or combination in which such TI products or services might be or are used.

Mailing Address:

Texas Instruments
Post Office Box 655303
Dallas, Texas 75265

EVM WARNINGS AND RESTRICTIONS

It is important to operate this EVM within the specified input and output ranges of 0V to 5V that are described in the EVM User's Guide.

Exceeding the specified input range may cause unexpected operation and/or irreversible damage to the EVM. If there are questions concerning the input range, please contact a TI field representative prior to connecting the input power.

Applying loads outside of the specified output range may result in unintended operation and/or possible permanent damage to the EVM. Please consult the EVM User's Guide prior to connecting any load to the EVM output. If there is uncertainty as to the load specification, please contact a TI field representative.

Mailing Address:

Texas Instruments
Post Office Box 655303
Dallas, Texas 75265

Copyright © 2004, Texas Instruments Incorporated

Read This First

About This Manual

This manual describes the DAC1220EVM evaluation fixture and how to use it. Throughout this document, the abbreviation EVM and the term *evaluation module* are synonymous with the DAC1220EVM.

Related Documentation From Texas Instruments

The following documents provide information regarding Texas Instruments integrated circuits used in the assembly of the DAC1220EVM. These documents are available from the TI web site, and are current at the time of the writing of this User's Guide. To obtain a copy of the following TI documents, visit our website at <http://www.ti.com/> or call the Texas Instruments Literature Response Center at (800) 477-8924 or the Product Information Center at (972) 644-5580. When ordering, identify the document by both title and literature number.

Data sheet	Literature number
DAC1220 Data Sheet	SBAS273
REF1004 Data Sheet	SBVS002
OPA335 Data Sheet	SBOS245
OPA350 Data Sheet	SBOS099
SN74LVC1G80 Data Sheet	SCES221

Additional Documentation

The following document provides information regarding selected non-TI components, which may be used in the testing of the DAC1220EVM. This document is available from the corresponding manufacturer.

Document	Manufacturer
HPA449 User's Guide	SoftBaugh, http://www.softbaugh.com

If You Need Assistance

If you have questions regarding either the use of this evaluation module or the information contained in the accompanying documentation, please contact the Texas Instruments Product Information Center at (972) 644-5580 or visit the TI web site at www.ti.com.

FCC Warning

This equipment is intended for use in a laboratory test environment only. It generates, uses, and can radiate radio frequency energy and has not been tested for compliance with the limits of computing devices pursuant to subpart J of part 15 of FCC rules, which are designed to provide reasonable protection against radio frequency interference. Operation of this equipment in other environments may cause interference with radio communications, in which case the user at his own expense will be required to take whatever measures may be required to correct this interference.

Trademarks

SPI is a registered trademark of Motorola, Inc.

I²C is a registered trademark of Royal Philips Electronics B.V., The Netherlands.

All other trademarks are the property of their respective owners.

Contents

1	Overview	1-1
1.1	Introduction	1-2
1.2	Built-In Accessories	1-2
1.3	Connectors	1-3
1.4	Controls	1-3
1.5	Setting Up	1-4
2	Circuit Description	2-1
2.1	DAC1220 and Ancillary Components	2-2
2.1.1	Filter Capacitors	2-2
2.1.2	Power	2-2
2.2	Clock Oscillator	2-3
2.3	Voltage Reference	2-3
2.4	Output Buffer Amplifier	2-4
2.5	Layout	2-4
3	Usage	3-1
3.1	I/O Connectors and Testpoints	3-2
3.1.1	J1: Analog Connector	3-3
3.1.2	J2: Serial Connector	3-4
3.1.3	J4: Power Connector	3-5
3.1.4	Testpoints	3-5
3.2	Jumpers	3-6
3.2.1	J3: DAC1220 Supply Current Measurement Jumpers	3-6
3.2.2	J5: DAC1220 Analog-Digital Ground Shorting Jumpers	3-6
3.3	Switches	3-7
3.3.1	S1: Reference Input Select	3-7
3.3.2	S2: System Clock Select	3-7
4	Schematic and Layout	4-1
4.1	Schematic	4-2
4.2	Board Layout	4-3
4.3	Bill of Materials	4-4

Figures

3-1. DAC1220EVM Connectors and Testpoints	3-2
3-2. Analog Connector Pinout for the DAC1220EVM	3-3
3-3. Serial Connector Pinout for the DAC1220EVM	3-4
3-4. Power Connector Pinout for the DAC1220EVM	3-5
3-5. DAC1220EVM Jumpers	3-6
3-6. Jumper Block J3 on the DAC1220EVM	3-6
3-7. DAC1220EVM Switches	3-7
4-1. DAC1220EVM Schematic	4-2
4-2. DAC1220EVM—Layer 1 (Top)	4-3
4-3. DAC1220EVM—Layer 2 (Bottom)	4-3

Tables

3-1. Analog Connector Pin Descriptions for the DAC1220EVM	3-3
3-2. Serial Connector Pin Descriptions for the DAC1220EVM	3-4
3-3. Power Connector Pin Descriptions for the DAC1220EVM	3-5
4-1. Bill of Materials	4-4

Overview

The DAC1220EVM is an evaluation fixture designed for the DAC1220 20-bit delta-sigma ($\Delta\Sigma$) digital-to-analog data converter. The EVM is designed for prototyping and evaluation, and includes a reference circuit, an oscillator circuit, and an output buffer amplifier. Use of the output buffer amplifier is optional.

Topic	Page
1.1 Introduction	1-2
1.2 Built-In Accessories	1-2
1.3 Connectors	1-3
1.4 Controls	1-3
1.5 Setting Up	1-4

1.1 Introduction

Many data converter evaluation fixtures contain a computer interface or a microcontroller, but the DAC1220EVM contains only the DAC1220 device and a few supporting components. All DAC1220 pins are accessible through various pins on the analog and digital connectors of the DAC1220EVM.

The DAC1220EVM is designed using a simple card format developed by TI. This simple, consistent design makes the DAC1220EVM very easy to connect to your own prototype system. One can even think of the DAC1220EVM as an alternate package for the DAC1220—one much larger than the device itself, but also much easier to wire up by hand on a test bench.

The DAC1220EVM can be plugged directly into suitable motherboards, such as the HPA449 MSP430 microcontroller development system from Soft-Baugh, Inc. (<http://www.softbaugh.com>). See also TI's web site for example code using the DAC1220EVM with the HPA449.

The DAC1220EVM, together with the HPA449 and the appropriate software, also forms a complete evaluation system for verifying the DAC1220 performance. See the Texas Instruments web site for additional information and software.

1.2 Built-In Accessories

The DAC1220EVM includes a system clock generator and a low-noise voltage reference. Using either of these components is optional; you can select an external system clock and/or an external reference, using the slide switches on the EVM.

The +2.5V reference circuit is based on a REF1004-2.5 voltage reference. Its noise performance is sufficient to allow the DAC1220 to perform at its lowest noise level.

The on-board clock circuit uses a 2.4576MHz crystal. A switch selects between the crystal and an external clock signal applied to the TOUT pin of the serial connector, J2.

1.3 Connectors

The DAC1220 device on the DAC1220EVM is connected through three headers: the analog connector, the serial connector, and the power connector. Pin-outs and locations of each connector are given in Chapter 3 of this user's guide.

The analog connector (J1) carries analog I/O. The DAC1220 output appears in buffered and unbuffered versions on this connector. An external voltage reference can be applied to the VREF pins.

The serial connector, J2, carries the DAC1220 serial digital interface, an optional external system clock signal, and an I²C™ connection to the on-board serial EEPROM.

The power connector (J4) carries the power supplies. The DAC1220EVM requires a +5V supply. The board is designed using a single ground net connected to DGND. An AGND pin is also provided and can be connected to DGND using jumper J5.

The DAC1220 uses separate supplies for its analog and digital sections. A jumper is inserted in each supply line. These jumpers allow the current of each supply to be measured independently.

1.4 Controls

The DAC1220EVM is configured using two slide switches. (See Figure 3–7 for the location of these switches.)

Switch S2 selects the system clock source for the DAC1220. You can select from the 2.4576MHz crystal or an external clock.

Switch S2 selects the reference input. One position selects the external reference input pins on the analog connector (J1); the other position selects the on-board +2.5V reference.

1.5 Setting Up

The way that one configures the DAC1220EVM depends on how it will be used. Consequently, there is no one single procedure to follow for setting up the DAC1220EVM.

Nevertheless, it is useful to remember the following points when you are configuring the board:

- Make certain that you have a +5V power supply connected to the proper pins on the power connector, J4.
- If you are not measuring the DAC1220 supply current, remember to place shunts on jumper block J3. Without these shunts, the DAC1220 will not be powered on, and will not work at all.
- Unless you are using two entirely separate power supplies for analog and digital sources, place a shorting block on jumper J2. This jumper connects the analog and digital supplies together, which is the usual method of operating the DAC1220.
- Check the system clock switch. If the switch is set to EXT, and you have not connected a clock signal to the external clock input pin on J2 (TOUT), the DAC1220 will not operate.

Circuit Description

This chapter describes the DAC1220EVM circuit design in detail.

The DAC1220EVM is designed to conform to TI's Modular EVM System. It contains only those parts of the circuit that will typically be used in an application immediately surrounding the DAC1220EVM. This includes:

- The DAC1220 and associated components
- An output buffer amplifier
- A +2.5V voltage reference
- A 2.4576MHz crystal
- Controls and I/O connectors

Each of these items is described in detail in this chapter, with the exception of the controls and connectors, which are described in Chapter 3.

The layout of a circuit incorporating the DAC1220 is critical. The layout used on the DAC1220EVM is briefly described in Section 2.5.

Topic	Page
2.1 DAC1220 and Ancillary Components	2-2
2.1.1 Filter Capacitors	2-2
2.1.2 Power	2-2
2.2 Clock Oscillator	2-3
2.3 Voltage Reference	2-3
2.4 Output Buffer Amplifier	2-4
2.5 Layout	2-4

2.1 DAC1220 and Ancillary Components

The DAC1220 requires the following elements in order to operate properly:

- Filter capacitors
- Clock source
- Voltage reference
- Power connections and bypassing

The output filter capacitors and power connections are described in the following two subsections.

2.1.1 Filter Capacitors

The filter capacitors determine the frequency response of the reconstruction filter in the DAC1220. The selected capacitor values depend on the desired resolution. For 16-bit resolution, smaller capacitors are used; these give a faster settling time at the expense of higher noise. For 20-bit resolution, larger capacitors are used; these give a slower settling time but generate lower noise.

The DAC1220EVM is shipped with the recommended capacitor values for 20-bit mode as given in the product data sheet. If 16-bit operation is desired, the capacitors can easily be removed and replaced because they are mounted to large (0805) surface-mount footprints.

The capacitors are not jumpered or switched due to the high sensitivity of the filter input nodes. This high sensitivity is also the reason that surface-mount capacitors are used instead of through-hole capacitors.

The capacitor type is also a factor. High-quality film capacitors having very low voltage coefficient have been chosen for this EVM. This selection is important for noise and INL performance.

2.1.2 Power

The DAC1220 must be well-bypassed to prevent its digital currents from causing ground bounce. On the DAC1220EVM, 10 multi-layer ceramic capacitors bypass both the AVDD and DVDD pins. These capacitors are placed ahead of the jumpers as close to the device as possible.

Layout is also a critical factor with regard to power supply; see Section 2.5 for details.

2.2 Clock Oscillator

The DAC1220EVM can be used with its on-board 2.4576MHz crystal or with an external clock source. A commonly-available crystal type in a through-hole HC49 package was used.

Selector switch S2 is inserted between the crystal and the DAC. The double-pole switch disconnects the crystal from the device entirely, to better simulate actual application conditions when using an external clock.

As with any CMOS Pierce crystal oscillator circuit, load capacitance is critical. On the DAC1220EVM, slightly lower load capacitor values are used to compensate for the added parasitic capacitance incurred by the switch and longer trace distance between the DAC and the crystal.

2.3 Voltage Reference

The voltage reference circuit is based on the Burr-Brown REF1004-2.5 voltage reference. This device offers low cost, low power consumption, and a relatively uniform noise characteristic well-suited to the DAC1220.

The reference input of the DAC1220 is somewhat demanding, so the REF1004-2.5 is buffered by an OPA350. The output of this is filtered by the large filter capacitor at the amplifier output for low noise. For even lower noise, a tantalum capacitor can be installed at C4.

An external reference voltage can be switched in using switch S1.

2.4 Output Buffer Amplifier

Although the DAC1220 incorporates an on-board amplifier, this is mainly designed as part of the DAC1220 continuous-time reconstruction filter, and has a relatively weak output drive capability. For some loads, a buffer is needed.

The buffer used on the DAC1220EVM is a unity-gain connected OPA335. This device, which is also used in the voltage reference circuit, offers extremely low voltage drift thanks to its auto-zeroing circuit.

Unfortunately, the OPA335 is not rail-to-rail; input voltages over approximately 4.2V cause the device output to swing to the positive supply rail. Although the DAC1220 does not have enough output drive to damage the OPA335, it may be helpful to apply a lower external reference voltage when using the buffer; for example, 2V.

2.5 Layout

The DAC1220EVM employs a two-layer printed circuit board (PCB). This was done to show the possibility of achieving maximum performance for the DAC1220 even on a low-cost PCB.

However, achieving good performance is not accidental. The DAC1220 combines fast digital and precision analog circuitry. The digital circuitry must be prevented from affecting the analog section. The primary enemy is ground current: a sufficient current passing by the appropriate point around the DAC1220 can cause a voltage jump that can appear on the output. Since CMOS circuitry operates using large switching and small quiescent currents, it is particularly prone to causing this phenomenon.

To mitigate this possible interference, large bypassing capacitors are employed at the AVDD and DVDD pins; *snubber* resistors are inserted in the digital lines to reduce the edge speeds of the control signals, and so spread out the current spike; and the layout is designed to give return currents easy paths to their sources, which avoid the sensitive parts of the DAC1220.

The DAC1220 has two extremely sensitive nodes, where the filter capacitors are connected. These pins are surrounded on the top layer by a polygon-fill connected to the voltage reference. This guard plane helps keep high-frequency interference from entering these sensitive nodes.

Usage

This chapter describes how to use the DAC1220EVM. It also describes the switches, jumpers, and connectors on the EVM in detail.

Topic	Page
3.1 I/O Connectors and Testpoints	3-2
3.1.1 J1: Analog Connector	3-3
3.1.2 J2: Serial Connector	3-4
3.1.3 J4: Power Connector	3-5
3.1.4 Testpoints	3-5
3.2 Jumpers	3-6
3.3 Switches	3-7

3.1.1 J1: Analog Connector

The analog connector pinout is shown in Figure 3–2 and described in Table 3–1.

Figure 3–2. Analog Connector Pinout for the DAC1220EVM

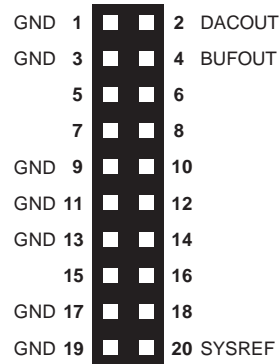

Table 3–1. Analog Connector Pin Descriptions for the DAC1220EVM

Pin No.	Pin Name	Standard Name	Direction	Function	Connection to DAC1220
1	AN0–	AN0–	Output	Signal ground for unbuffered output	Ground
2	AN0+	AN0+	Output	Unbuffered output	Direct
3	AN1–	AN1–	Output	Signal ground for buffered output	Ground
4	AN1+	AN1+	Output	Buffered output	Through buffer
20	SYSREF	REF+	Input	External reference input	n/a

3.1.2 J2: Serial Connector

The serial connector pinout is shown in Figure 3–3 and described in Table 3–2.

Figure 3–3. Serial Connector Pinout for the DAC1220EVM

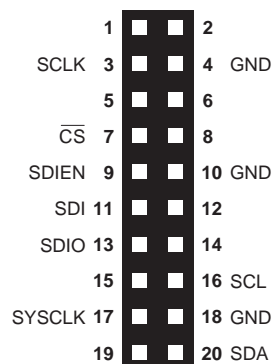

Table 3–2. Serial Connector Pin Descriptions for the DAC1220EVM

Pin Number	Pin Name	Standard Name	Direction	Function
3	SCLK	CLKX	Input	SPI clock
7	$\overline{\text{CS}}$	FSX	Input	Chip select (Active low)
9	SDIEN	FSR	Input	Driver enable
11	SDI	DX	Input	SPI data in (MOSI)
13	SDIO	DR	I/O	SPI data in/out
17	SYSCLK	TOUT	Input	External clock input
16	SCL	SCL	I/O	I ² C clock
18	SDA	SDA	I/O	I ² C data
4, 10, 18	GND	DGND	Power	Ground

The DAC1220 serial interface is a bidirectional variant of SPI™. It uses an input clock, SCLK, and a bidirectional data line called SDIO.

Most SPI controllers do not have a bidirectional data line; they have an output line, typically called SDO, MOSI, or MISO, and an input line, typically called SDI, MISO, or SOMI. To more easily support these interfaces, the DAC1220EVM includes a tristate buffer connected to the serial connector input line. The buffer can be enabled and disabled using pin 9 on the serial connector; a low on this line activates the buffer.

If you use an SPI interface, set this line low before writing data to the DAC1220EVM, and high when receiving data from the DAC1220EVM. Be certain to only activate the line when the DAC1220 is not sending data. However, the 100Ω resistor in the SDIO line should prevent excessive current consumption during driver contention.

The interface can easily be bit-banged. To bit-bang in bidirectional mode, fix pin 9 high, and use only the DR pin for both transmit and receive.

SCL and SDA are used to communicate with the I²C serial EEPROM.

3.1.3 J4: Power Connector

The power connector pinout is shown in Figure 3–4 and described in Table 3–3

Figure 3–4. Power Connector Pinout for the DAC1220EVM

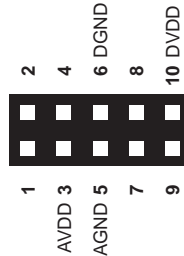

Table 3–3. Power Connector Pin Descriptions for the DAC1220EVM

Pin Number	Pin Name	Standard Name	Function
3	AVDD	+5VA	Analog power supply
5	GND	AGND	Analog/main ground
6	DGND	DGND	Digital ground from motherboard
10	DVDD	+5VD	Digital power supply

The DAC1220 has separate analog and digital power supply connections. Both supplies must be +5V. The motherboard must supply both voltages; however, both may (and usually do) come from the same source.

The DAC1220 has separate analog and digital ground connections for internal layout reasons; the DAC1220EVM uses a single ground plane. The motherboard may have separate ground domains on AGND and DGND. The DAC1220EVM takes its ground connection from AGND. You can connect DGND to AGND on the DAC1220EVM using jumper J5, as described in section 3.2.2.

3.1.4 Testpoints

There is one testpoint on the board; it is marked TP1. The testpoint is connected to the DAC1220 VREF input. This testpoint is positioned very near the chip VREF input, which allows its reference to be measured with good accuracy. This is useful for calibration purposes.

3.2 Jumpers

The jumpers are shown in Figure 3–5.

Figure 3–5. DAC1220EVM Jumpers

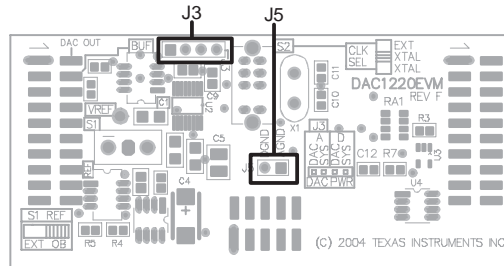

3.2.1 J3: DAC1220 Supply Current Measurement Jumpers

Jumper block J3 is shown in Figure 3–6.

Figure 3–6. Jumper Block J3 on the DAC1220EVM



This jumper block can be used to measure the current drawn by the DAC1220 power supplies.

For normal operation, when not measuring current, place shunting blocks across both jumper positions in the block.

3.2.2 J5: DAC1220 Analog-Digital Ground Shorting Jumpers

This jumper is used to connect the analog and digital grounds together.

If you are using a single power supply, you should usually place a shunting block across this jumper. If you are using two different supplies (each with its own ground), you should usually leave this jumper unconnected.

Schematic and Layout

This chapter contains the complete bill of materials, schematic, and PCB layout for the DAC1220EVM.

Note:

Board layouts are not to scale. These are intended to show how the board is laid out; they are not intended to be used for manufacturing DAC1220EVM PCBs.

Topic	Page
4.1 Schematic	4-2
4.1 Schematic	4-2
4.3 Bill of Materials	4-4

4.1 Schematic

Figure 4–1. DAC1220EVM Schematic

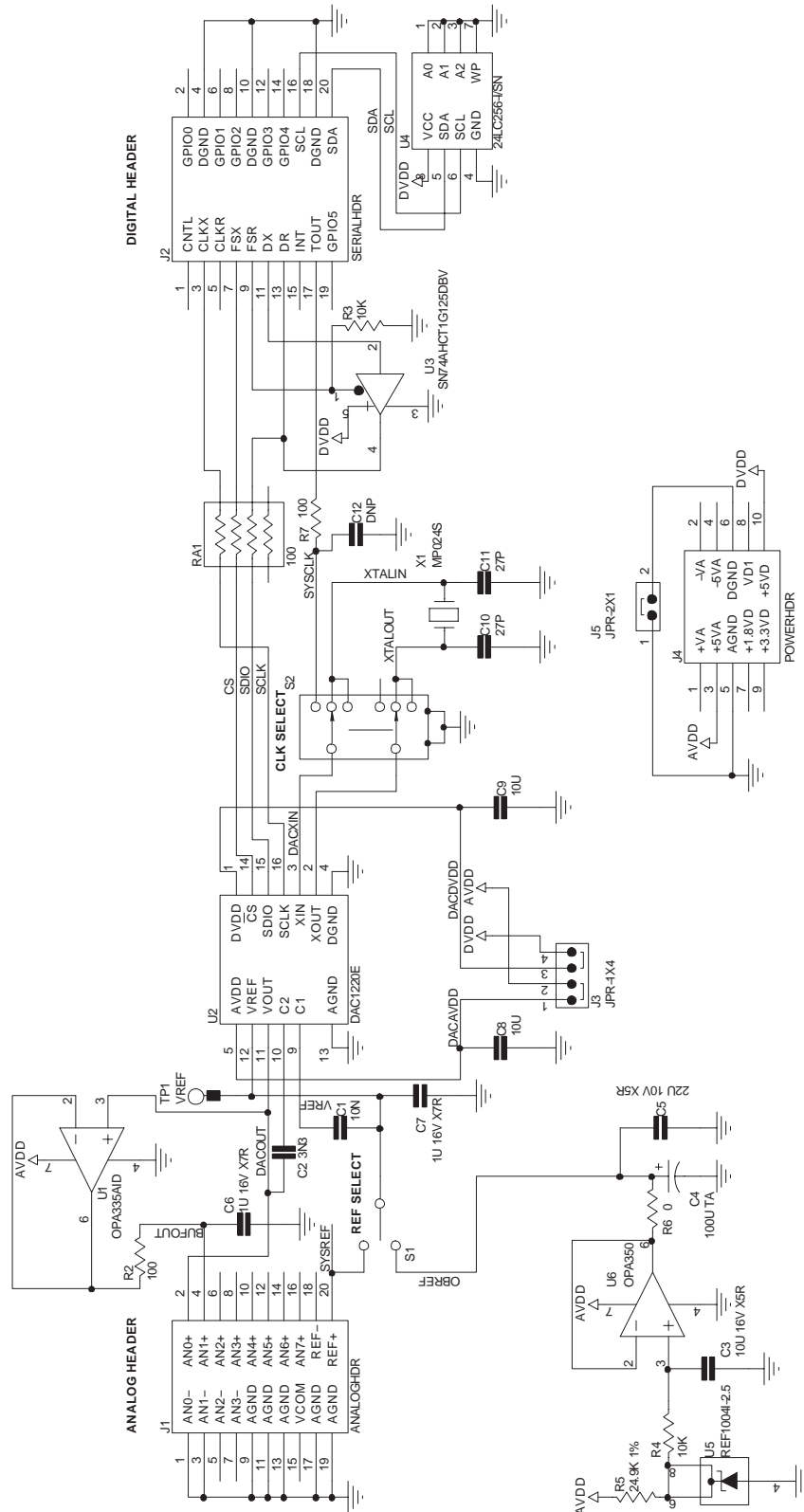

4.2 Board Layout

Figure 4-2. DAC1220EVM—Layer 1 (Top)

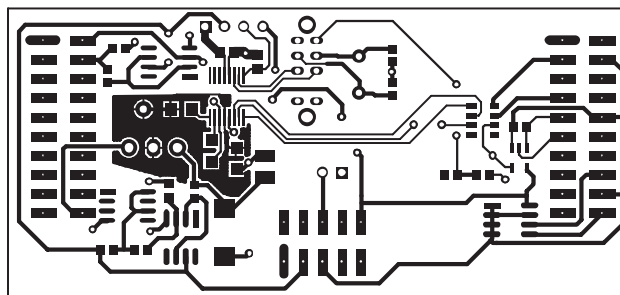
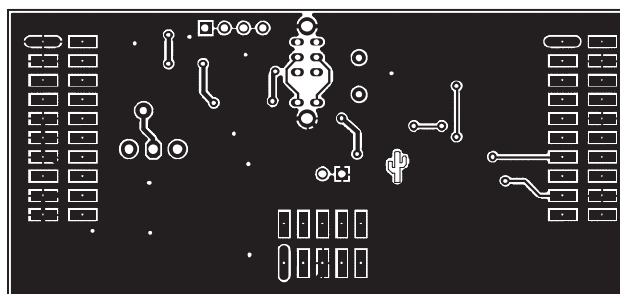

Figure 4-3. DAC1220EVM—Layer 2 (Bottom side, viewed from top)



4.3 Bill of Materials

Table 4–1. Bill of Materials

Reference Designator	Description	Vendor	Part Number
R2, R7	100Ω 1/16W 5% chip resistor	Panasonic	ERJ-3GEYJ101V
R3, R4	10kΩ 1/16W 5% chip resistor	Panasonic	ERJ-3GEYJ103V
R5	24.9kΩ 1/16W 1% chip resistor	Panasonic	ERJ-3EKF24R9V
R6	0Ω 1/10W 5% chip resistor	Panasonic	ERJ-3GEY0R00V
RA1	100Ω resistor array	CTS	744C083101JTR
C1	10nF 50V 2% PPS film capacitor	Panasonic	ECH-U1H103GX5
C2	3.3nF 50V 2% PPS film capacitor	Panasonic	ECH-U1H332GX5
C5	22μF 16V X5R 20% ceramic chip resistor	TDK	C3225X5R1C226M
C6	1μF 16V X5R 10% ceramic chip resistor	TDK	C1608X5R1C105K
C7	1μF 16V X7R 10% ceramic chip resistor	TDK	C3216X7R1C226M
C8, C9, C3	10μF 6.3V X5R 20% ceramic chip resistor	TDK	C2012X5R0J106M
U1	Operational amplifier	Texas Instruments	OPA335AID
U2	Digital-to-analog converter	Texas Instruments	DAC1220E
U3	Tri-state buffer	Texas Instruments	SN74AHCT1G125DBV
U4	256K I ² C EEPROM	Microchip	24LC256-I/SN
U5	2.5V voltage reference	Texas Instruments	REF1104I-2.5
U6	Operational amplifier	Texas Instruments	OPA350UA
X1	2.4576MHz crystal, 25pF load	CTS	MP024S