



28V_{IN}, 3.3 to 15V_{OUT}, ZVS Isolated Converter Module Family

Product Description

The ZVS Isolated Converter Module Series consists of high-density isolated DC-DC converters implementing Zero-Voltage Switching topology.

The 28V_{IN} series operates over a wide range input of 16V to 50V_{DC}, delivering 50W of output power, yielding an unprecedented power density of 334W/in³.

These converter modules are surface mountable and only ~0.5in square in area achieving ~50% space reduction versus conventional solutions.

Device	Output Voltage		I _{OUT} Max
	Set	Range	
PI3108-00-HVMZ	3.3V	2.97 – 3.63V	10A
PI3109-00-HVMZ	5V	4 – 5.5V	10A
PI3106-00-HVMZ	12V	9.6 – 13.2V	4.2A
PI3111-00-HVMZ	15V	12 – 16.5V	3.33A

The switching frequency of 900kHz allows for small input and output filter components which further reduces the total size and cost of the overall system solution. The output voltage is sensed and fed back to the internal controller using a high performance isolated magnetic feedback scheme which allows for high bandwidth and good common mode noise immunity.

The PI31xx-00-HVMZ series requires no external feedback compensation and offers a total solution with a minimum number of external components. A rich feature set is offered, including output voltage trim capability, output overvoltage protection, adjustable soft start, overcurrent protection with auto-restart, over and under input voltage lockout and a temperature monitoring and protection function that provides an analog voltage proportional to the die temperature as well as shut down and alarm capabilities.

Features & Benefits

- Efficiency up to 88%
- High switching frequency minimizes input filter requirements and reduces output capacitance
- Proprietary “Double-Clamped” ZVS Buck-Boost Topology
- Proprietary isolated magnetic feedback
- Small footprint (0.57in²) enables PCB area savings
- Very low profile (0.265in)
- Wide input voltage range operation (16 – 50V_{DC})
- On/Off Control, positive logic
- Wide trim range +10/-20% most models
- Temperature Monitor (TM) & Overtemperature Protection (OTP)
- Input UVLO & OVLO and output OVP
- Overcurrent protection with auto restart
- Adjustable soft start
- 2250V_{DC} input-to-output isolation

Applications

- Wide Temperature, Aerospace & Defense Applications
- Space-Constrained Systems
- Isolated Board-Level Power

Package Information

- Surface Mountable 0.87 x 0.65 x 0.265in package
- Weight = 7.8 grams



Contents

Order Information	3
Absolute Maximum Ratings	4
Functional Block Diagram	5
Pin Description	6
Package Pinout	6
PI3108-00-HVMZ Electrical Characteristics	7
PI3109-00-HVMZ Electrical Characteristics	11
PI3106-00-HVMZ Electrical Characteristics	15
PI3111-00-HVMZ Electrical Characteristics	19
Functional Description	23
Input Power Pins IN(+) and IN(-)	23
ENABLE	23
TRIM/SS Pin	23
TM	24
SGND	24
Output Power Pins +OUT and -OUT	24
Package Outline & Recommended PCB Land Pattern	25
Product Warranty	26

Order Information

Part Number	V _{IN}	V _{OUT}	I _{OUT} Max	Package	Transport Media
PI3108-00-HVMZ	16 – 50V	3.3V	10A	0.87 x 0.65 x 0.265in	TRAY
PI3109-00-HVMZ	16 – 50V	5V	10A	0.87 x 0.65 x 0.265in	TRAY
PI3106-00-HVMZ	16 – 50V	12V	4.2A	0.87 x 0.65 x 0.265in	TRAY
PI3111-00-HVMZ	16 – 50V	15V	3.33A	0.87 x 0.65 x 0.265in	TRAY
Also Available					
PI3101-00-HVIZ	36 – 75V	3.3V	18A	0.87 x 0.65 x 0.265in	TRAY
PI3105-00-HVIZ	36 – 75V	12V	5A	0.87 x 0.65 x 0.265in	TRAY
PI3110-01-HVIZ	41 – 57V	18V	3.3A	0.87 x 0.65 x 0.265in	TRAY
PI3109-01-HVIZ	18 – 36V	5V	10A	0.87 x 0.65 x 0.265in	TRAY
PI3106-01-HVIZ	18 – 36V	12V	4.2A	0.87 x 0.65 x 0.265in	TRAY

Absolute Maximum Ratings

Name	Rating
+IN to -IN Max Operating Voltage	-1.0 to 50V _{DC} (operating)
+IN to -IN Max Peak Voltage	55V _{DC} (non-operating, 12.5ms)
ENABLE to -IN	-0.3 to 6.0V _{DC}
TM to -IN	-0.3 to 6.0V _{DC}
TRIM/SS to -IN	-0.3 to 6.0V _{DC}
+OUT to -OUT	See relevant model output section
Isolation Voltage (+IN/-IN to +OUT/-OUT)	2250V _{DC}
Continuous Output Current	See relevant model output section
Peak Output Current	See relevant model output section
Operating Junction Temperature	-55 to 125°C
Storage Temperature	-65 to 125°C
Case Temperature During Reflow	245°C
Peak Compressive Force Applied to Case (Z-axis)	3lbs (supported by J-lead only)

Functional Block Diagram

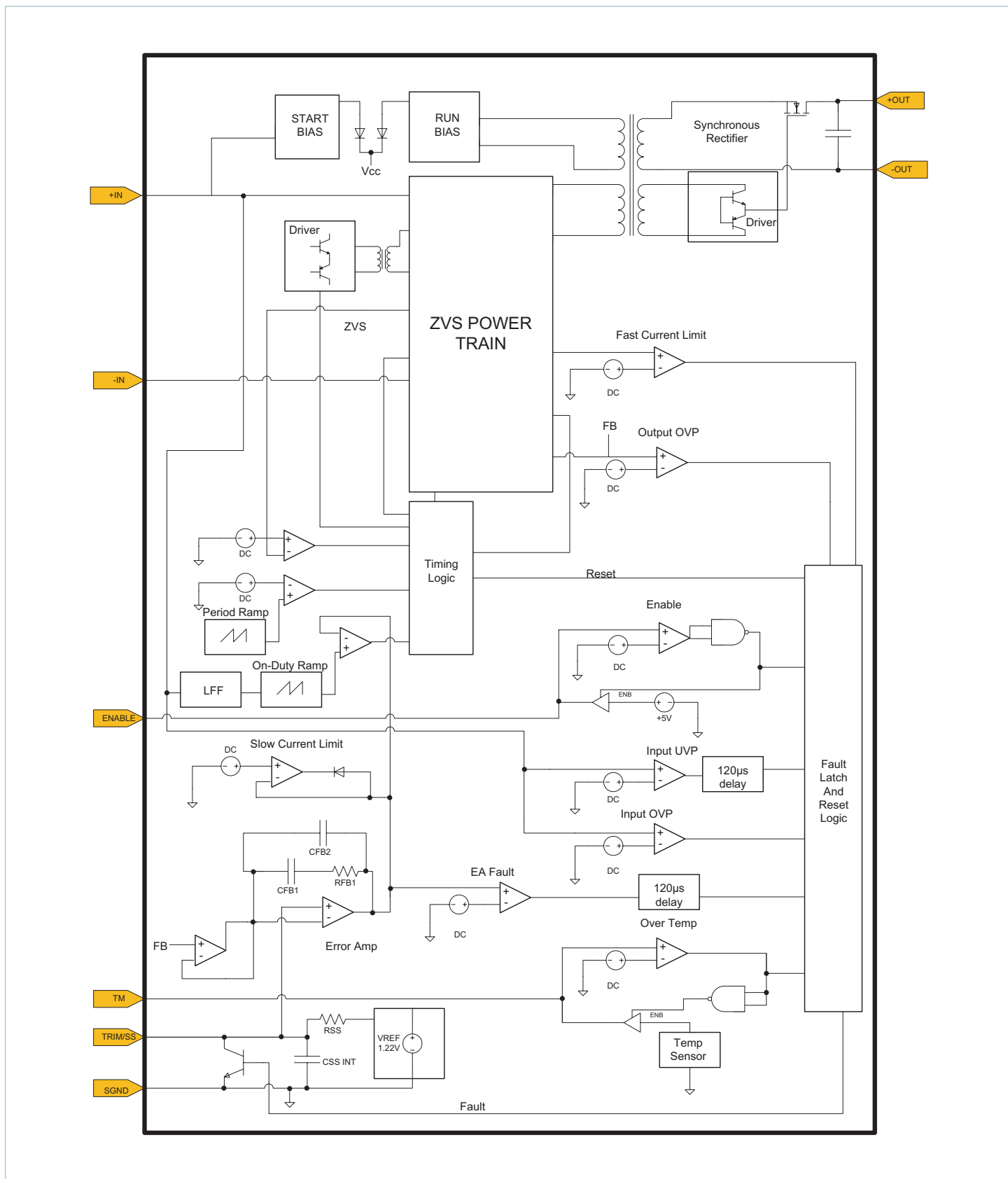

Pin Description

Pin Name	Description
+IN	Primary side positive input voltage terminals.
-IN	Primary side negative input voltage terminals.
ENABLE	Converter enable option, functions as 5V reference and on / off control pin. Pull low for off.
TRIM/SS	External soft-start pin and trim function. Connect to SGND or ENABLE through resistor for trim up or trim down.
TM	Temperature measurement output pin.
SGND	Signal ground, primary side referenced.
+OUT	Isolated secondary DC output voltage positive terminals.
-OUT	Isolated secondary DC output voltage negative terminals.

Package Pinout



PI3108-00-HVMZ Electrical Characteristics

Unless otherwise specified: $16V < V_{IN} < 50V$, $0A < I_{OUT} < 10A$, $-55^{\circ}C < T_{CASE} < 100^{\circ}C$ [a]

Parameter	Symbol	Conditions	Min	Typ	Max	Unit
Input Specifications						
Input Voltage Range	V_{IN}		16	28	50	V_{DC}
Input dV/dt [a]	V_{INDVDT}	$V_{IN} = 50V$			1.0	$V/\mu s$
Input Undervoltage Turn-on	V_{UVON}	$I_O = 10A$	14.5	15.3	16	V_{DC}
Input Undervoltage Turn-off	V_{UVOFF}	$I_O = 10A$	13.5	14.1	15.2	V_{DC}
Input Undervoltage Hysteresis	V_{UVH}	$I_O = 10A$		1.2		V_{DC}
Input Overvoltage Turn-on	V_{OVON}	$I_O = 10A$	50	52.5	54	V_{DC}
Input Overvoltage Turn-off	V_{OVOFF}	$I_O = 10A$	51	53.7	55	V_{DC}
Input Overvoltage Hysteresis	V_{OVH}	$I_O = 10A$		1.2		V_{DC}
Input Quiescent Current	I_Q	$V_{IN} = 28V$, $ENABLE = 0V$		2		mA_{DC}
Input Idling Power	P_{IDLE}	$V_{IN} = 28V$, $I_{OUT} = 0A$		2.6		W
Input Standby Power	P_{SBY}	$V_{IN} = 28V$, $ENABLE = 0V$		0.048		W
Input Current Full Load	I_{IN}	$T_{CASE} = 100^{\circ}C$, $I_{OUT} = 10A$, $\eta_{FL} = 86\%$ typical, $V_{IN} = 28V$		1.37		A_{DC}
Input Reflected Ripple Current	I_{INRR}	$L_{IN} = 0.47\mu H$ $C_{IN} = 100\mu F$ 63V electrolytic + 2 x 4.7 μF 50V X7R ceramic		15		mApp
Recommended Ext Input Capacitance	C_{IN}	$C_{IN} = 100\mu F$ 63V electrolytic + 2 x 4.7 μF 50V X7R ceramic $C_{IN} = C_{bulk} + C_{hf}$		109.4		μF
Output Specifications						
Output Voltage Set Point	V_{OUT}	$I_{OUT} = 5A$		3.3		V_{DC}
Total Output Accuracy	V_{OA}	$-0^{\circ}C < T_{CASE} < 100^{\circ}C$	-3		+3	%
		$-55^{\circ}C < T_{CASE} < 0^{\circ}C$	-5		+3	%
Output Voltage Trim Range	V_{OAJD}		-10		10	%
Output Current Range	I_{OUT}				10	A_{DC}
Overcurrent Protection	I_{OCP}		11.0	15	20	A_{DC}
Efficiency – Full Load	η_{FL}	$T_{CASE} = 100^{\circ}C$, $V_{IN} = 28V$	84	86		%
Efficiency – Half Load	η_{HL}	$T_{CASE} = 100^{\circ}C$, $V_{IN} = 28V$	80	82		%
Output OVP Set Point	V_{OVP}		3.9	4.1	4.3	V_{DC}
Output Ripple Voltage	V_{ORPP}	$C_{OUT} = 6 \times 10\mu F$ 10V X7R DC-20MHz		90		mVpp
Switching Frequency	f_{SW}			900		kHz
Output Turn-on Delay Time	t_{ONDLY}	$V_{IN} = V_{UVON}$ to $ENABLE = 5V$; V_{IN} rise time < 1ms		80		ms
Output Turn-off Delay Time	t_{OFFDLY}	$V_{IN} = V_{UVOFF}$ to $ENABLE < 2.35V$		375		μs
Soft-Start Ramp Time	t_{SS}	$ENABLE = 5V$ to 90% V_{OUT} $C_{REF} = 0$		380		μs
Maximum Load Capacitance	C_{OUT}	$C_{REF} = 0.22\mu F$, $C_{OUT} = Al$ Electrolytic			4700	μF
Load Transient Deviation	V_{ODV}	$I_{OUT} = 50\%$ step $0.1A/\mu s$ $C_{OUT} = 6 \times 10\mu F$ 10V X7R		145		mV
Load Transient Recovery Time	t_{OVR}	$I_{OUT} = 50\%$ step $0.1A/\mu s$ $C_{OUT} = 6 \times 10\mu F$ 10V X7R $V_{OUT} \leq 1\%$		100		μs
Maximum Output Power	P_{OUT}			33		W
Absolute Maximum Output Ratings						
Name	Rating					
+OUT to -OUT	-0.5V to 6.8V _{DC}					
Continuous Output Current	10A _{DC}					
Peak Output Current	20A _{DC}					

[a] These parameters are not production tested but are guaranteed by design, characterization and correlation with statistical process control. Unless otherwise specified, ATE tests are completed at room temperature.

[b] Current flow sourced by a pin has a negative sign.

PI3108-00-HVMZ Electrical Characteristics (Cont.)

Parameter	Symbol	Conditions	Min	Typ	Max	Unit
ENABLE						
DC Voltage Reference Output	V_{ERO}		4.65	4.9	5.15	V_{DC}
Output Current Limit ^[b]	I_{ECL}	ENABLE = 3.3V	-3.3	-2.6	-1.9	mA_{DC}
Start Up Current Limit ^[b]	I_{ESL}	ENABLE = 1V	-120	-90	-60	μA
Module Enable Voltage	V_{EME}		1.95	2.5	3.05	V_{DC}
Module Disable Voltage	V_{EMD}		1.8	2.35	2.9	V_{DC}
Disable Hysteresis	V_{EDH}			150		mV
Enable Delay Time	t_{EE}			10		μs
Disable Delay Time	t_{ED}			10		μs
Maximum Capacitance	C_{EC}				1500	pF
Maximum External Toggle Rate	f_{EXT}				1	Hz
TRIM/SS						
Trim Voltage Reference	V_{REF}			1.240		V_{DC}
Internal Capacitance	C_{REFI}			10		nF
External Capacitance	C_{REF}				0.22	μF
Internal Resistance	R_{REFI}			10		k Ω
TM (Temperature Monitor)						
Temperature Coefficient ^[a]	TM_{TC}			10		mV / $^{\circ}K$
Temperature Full Range Accuracy ^[a]	TM_{ACC}		-5		5	$^{\circ}K$
Drive Capability	I_{TM}		-100			μA
TM Output Setting	V_{TM}	Ambient Temperature = 300 $^{\circ}K$		3.00		V
Thermal Specification						
Junction Temperature Shutdown ^[a]	T_{MAX}		130	135	140	$^{\circ}C$
Junction-to-Case Thermal Impedance	θ_{J-C}			3		$^{\circ}C / W$
Case-to-Ambient Thermal Impedance	θ_{C-A}	Mounted on 9in ² 1oz. Cu 6 layer PCB 25 $^{\circ}C$		9.6		$^{\circ}C / W$
Soldering						
Peak Temperature During Reflow		MSL 5; time on floor = 48 hours			225	$^{\circ}C$
		MSL 6; time on floor = 4 hours			245	$^{\circ}C$
Regulatory Specification						
IEC 60950-1:2005 (2nd Edition)						
EN 60950-1:2006						
IEC 61000-4-2						
UL60950-1:2007						
CAN/CSA C22.2 NO. 60950-1-07						
Recommended Input Fuse Rating	I_{FUSE}	Fast acting LITTLEFUSE Nano ² Series Fuse	4		10	A

^[a] These parameters are not production tested but are guaranteed by design, characterization and correlation with statistical process control. Unless otherwise specified, ATE tests are completed at room temperature.

^[b] Current flow sourced by a pin has a negative sign.

PI3108-00-HVMZ Electrical Characteristics (Cont.)

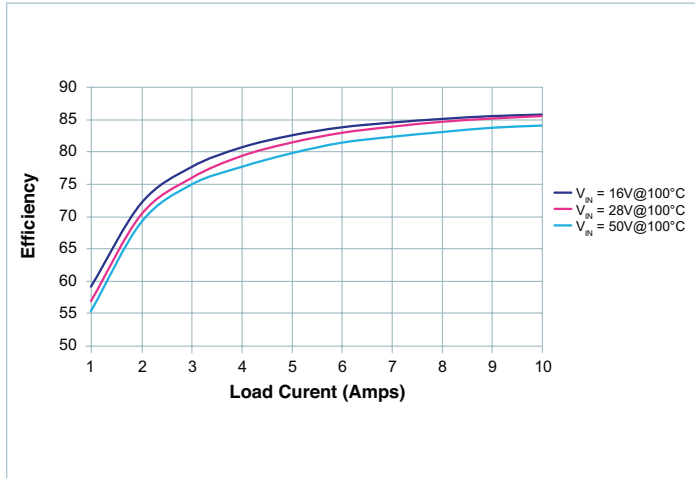

Figure 1 — Conversion efficiency

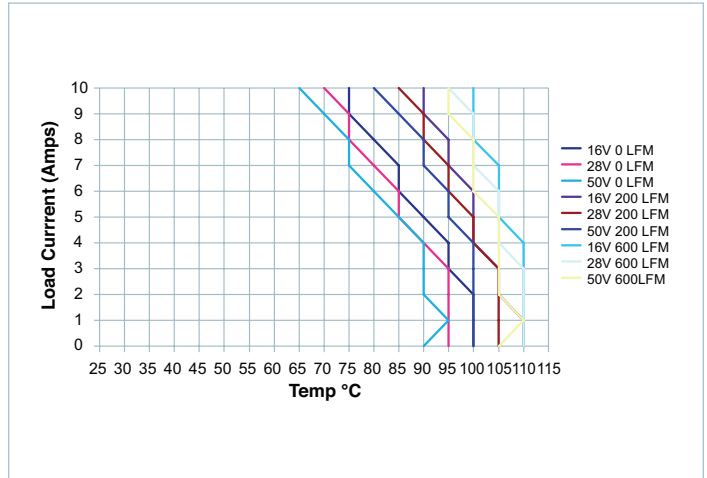

Figure 4 — Load current vs. temperature (11mm heat sink)

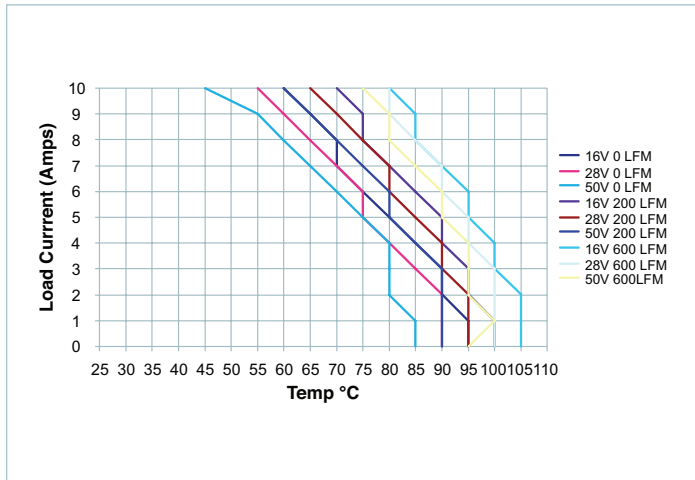

Figure 2 — Load current vs. temperature (without heat sink)

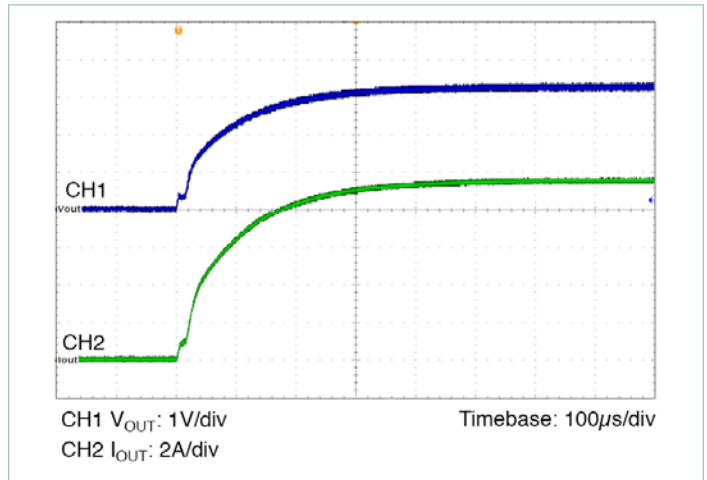

Figure 5 — Start up, $C_{REF} = 0$ ($V_{IN} = 16V$, $I_{OUT} = 10A$, C_R , $C_{OUT} = 6 \times 10\mu F$ X7R ceramic)

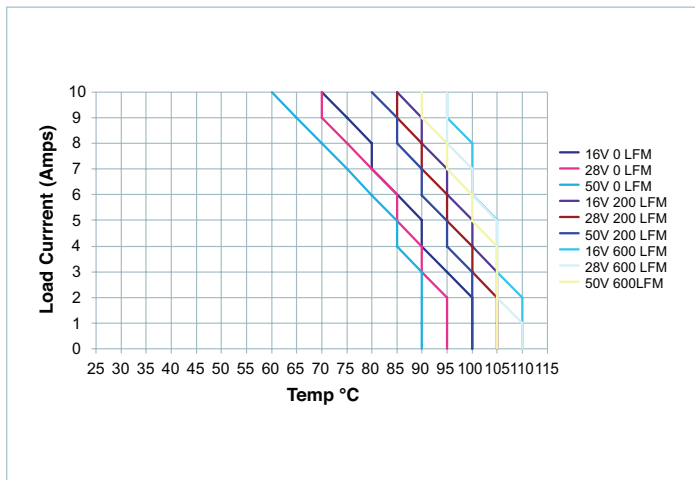

Figure 3 — Load current vs. temperature (6.33mm heat sink)

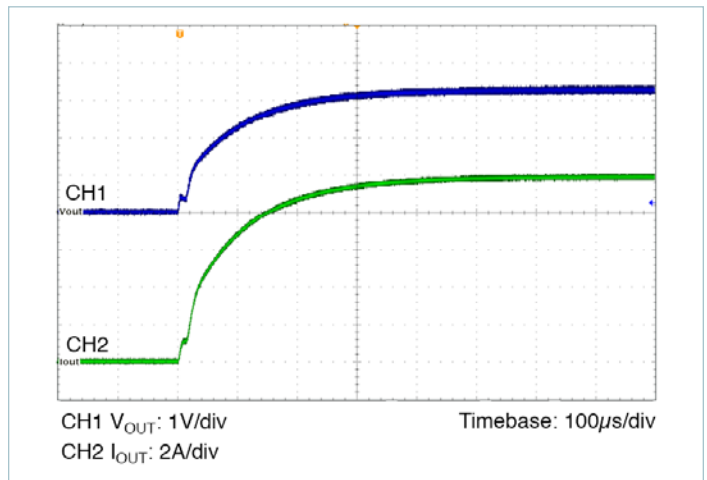

Figure 6 — Start up, $C_{REF} = 0$ ($V_{IN} = 28V$, $I_{OUT} = 10A$, C_R , $C_{OUT} = 6 \times 10\mu F$ X7R ceramic)

PI3108-00-HVMZ Electrical Characteristics (Cont.)

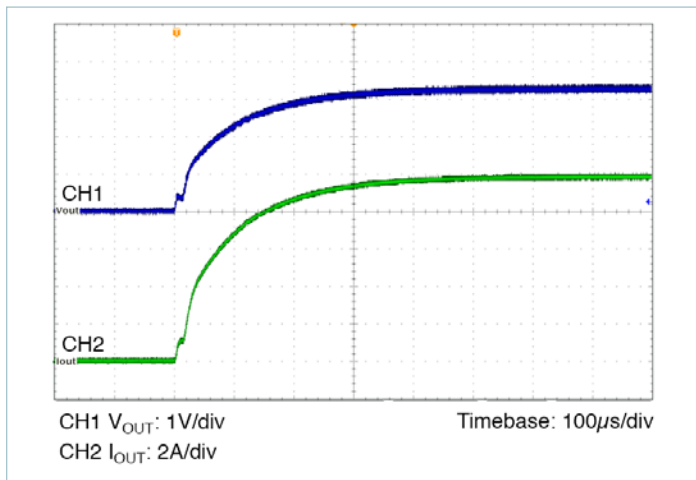

Figure 7 — Start up, $C_{REF} = 0$ ($V_{IN} = 50V$, $I_{OUT} = 10A$, CR, $C_{OUT} = 6 \times 10\mu F$ X7R ceramic)

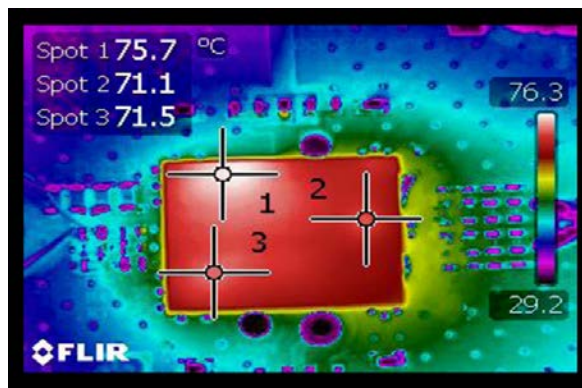

Figure 10 — Thermal image ($V_{IN} = 28V$, $I_{OUT} = 10A$, CR, 0LFM evaluation PCB)

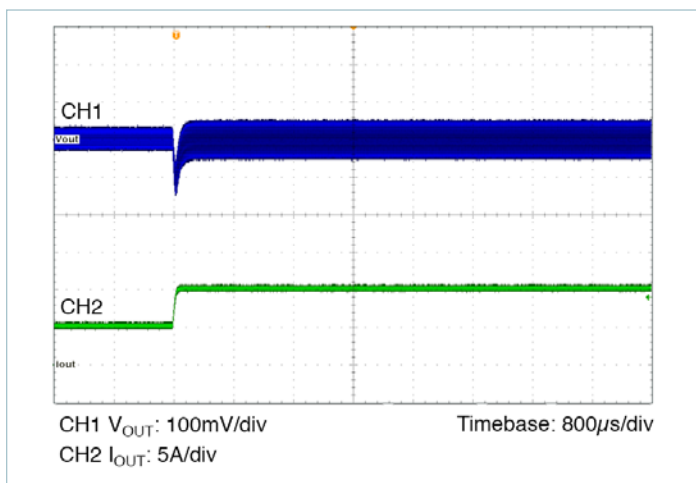

Figure 8 — Transient response ($V_{IN} = 28V$, $I_{OUT} = 5 - 10A$, 0.1A/µs, $C_{OUT} = 6 \times 10\mu F$ X7R ceramic)

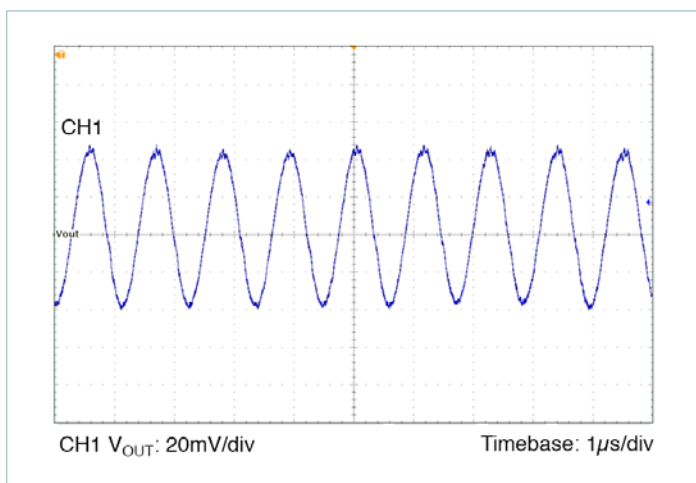

Figure 9 — Output ripple ($V_{IN} = 28V$, $I_{OUT} = 10A$, CR, $C_{OUT} = 6 \times 10\mu F$ X7R ceramic)

PI3109-00-HVMZ Electrical Characteristics

Unless otherwise specified: $16V < V_{IN} < 50V$, $0A < I_{OUT} < 10A$, $-55^{\circ}C < T_{CASE} < 100^{\circ}C$ ^[a]

Parameter	Symbol	Conditions	Min	Typ	Max	Unit
Input Specifications						
Input Voltage Range	V_{IN}		16	28	50	V_{DC}
Input dV/dt ^[a]	V_{INDVDT}	$V_{IN} = 50V$			1.0	$V/\mu s$
Input Undervoltage Turn-on	V_{UVON}	$I_O = 10A$	14.5	15.3	16	V_{DC}
Input Undervoltage Turn-off	V_{UVOFF}	$I_O = 10A$	13.5	14.1	15.2	V_{DC}
Input Undervoltage Hysteresis	V_{UVH}	$I_O = 10A$		1.2		V_{DC}
Input Overvoltage Turn-on	V_{OVON}	$I_O = 10A$	50.0	52.5	54	V_{DC}
Input Overvoltage Turn-off	V_{OVOFF}	$I_O = 10A$	51	53.7	55	V_{DC}
Input Overvoltage Hysteresis	V_{OVH}	$I_O = 10A$		1.2		V_{DC}
Input Quiescent Current	I_Q	$V_{IN} = 28V$, $ENABLE = 0V$		2		mA_{DC}
Input Idling Power	P_{IDLE}	$V_{IN} = 28V$, $I_{OUT} = 0A$		3.5		W
Input Standby Power	P_{SBY}	$V_{IN} = 28V$, $ENABLE = 0V$		0.056		W
Input Current Full Load	I_{IN}	$T_{CASE} = 100^{\circ}C$, $I_{OUT} = 10A$, $\eta_{FL} = 88\%$ typical, $V_{IN} = 28V$		2.03		A_{DC}
Input Reflected Ripple Current	I_{INRR}	$L_{IN} = 0.47\mu H$ $C_{IN} = 100\mu F$ 63V electrolytic + 2 x 4.7 μF 50V X7R ceramic		13		mApp
Recommended Ext Input Capacitance	C_{IN}	$C_{IN} = 100\mu F$ 63V electrolytic + 2 x 4.7 μF 50V X7R ceramic $C_{IN} = C_{bulk} + C_{hf}$		109.4		μF
Output Specifications						
Output Voltage Set Point	V_{OUT}	$I_{OUT} = 5A$		5.0		V_{DC}
Total Output Accuracy	V_{OA}	$-0^{\circ}C < T_{CASE} < 100^{\circ}C$	-3		+3	%
		$-55^{\circ}C < T_{CASE} < 0^{\circ}C$	-5		+3	%
Output Voltage Trim Range	V_{OAdj}		-20		10	%
Output Current Range	I_{OUT}				10	A_{DC}
Overcurrent Protection	I_{OCP}		10.8	15	20	A_{DC}
Efficiency – Full Load	η_{FL}	$T_{CASE} = 100^{\circ}C$, $V_{IN} = 28V$	86	88		%
Efficiency – Half Load	η_{HL}	$T_{CASE} = 100^{\circ}C$, $V_{IN} = 28V$	83.5	85.5		%
Output OVP Set Point	V_{OVP}		6.0	6.3	6.6	V_{DC}
Output Ripple Voltage	V_{ORPP}	$C_{OUT} = 6 \times 10\mu F$ 10V X7R DC-20MHz		135		mVpp
Switching Frequency	f_{SW}			900		kHz
Output Turn-on Delay Time	t_{ONDLY}	$V_{IN} = V_{UVON}$ to $ENABLE = 5V$; V_{IN} rise time < 1ms		80		ms
Output Turn-off Delay Time	t_{OFFDLY}	$V_{IN} = V_{UVOFF}$ to $ENABLE < 2.35V$		375		μs
Soft-Start Ramp Time	t_{SS}	$ENABLE = 5V$ to 90% V_{OUT} $C_{REF} = 0$		230		μs
Maximum Load Capacitance	C_{OUT}	$C_{REF} = 0.22\mu F$, $C_{OUT} = Al$ Electrolytic			4700	μF
Load Transient Deviation	V_{ODV}	$I_{OUT} = 50\%$ step 0.1A/ μs $C_{OUT} = 6 \times 10\mu F$ 10V X7R		90		mV
Load Transient Recovery Time	t_{OVR}	$I_{OUT} = 50\%$ step 0.1A/ μs $C_{OUT} = 6 \times 10\mu F$ 10V X7R $V_{OUT} \leq 1\%$		100		μs
Maximum Output Power	P_{OUT}			50		W
Absolute Maximum Output Ratings						
Name	Rating					
+OUT to -OUT	-0.5V to 6.8V _{DC}					
Continuous Output Current	10A _{DC}					
Peak Output Current	20A _{DC}					

^[a] These parameters are not production tested but are guaranteed by design, characterization and correlation with statistical process control. Unless otherwise specified, ATE tests are completed at room temperature.

^[b] Current flow sourced by a pin has a negative sign.

PI3109-00-HVMZ Electrical Characteristics (Cont.)

Parameter	Symbol	Conditions	Min	Typ	Max	Unit
ENABLE						
DC Voltage Reference Output	V_{ERO}		4.65	4.9	5.15	V_{DC}
Output Current Limit ^[b]	I_{ECL}	ENABLE = 3.3V	-3.3	-2.6	-1.9	mA_{DC}
Start Up Current Limit ^[b]	I_{ESL}	ENABLE = 1V	-120	-90	-60	μA
Module Enable Voltage	V_{EME}		1.95	2.5	3.05	V_{DC}
Module Disable Voltage	V_{EMD}		1.8	2.35	2.9	V_{DC}
Disable Hysteresis	V_{EDH}			150		mV
Enable Delay Time	t_{EE}			10		μs
Disable Delay Time	t_{ED}			10		μs
Maximum Capacitance	C_{EC}				1500	pF
Maximum External Toggle Rate	f_{EXT}				1	Hz
TRIM/SS						
Trim Voltage Reference	V_{REF}			1.240		V_{DC}
Internal Capacitance	C_{REFI}			10		nF
External Capacitance	C_{REF}				0.22	μF
Internal Resistance	R_{REFI}			10		k Ω
TM (Temperature Monitor)						
Temperature Coefficient ^[a]	TM_{TC}			10		mV / $^{\circ}K$
Temperature Full Range Accuracy ^[a]	TM_{ACC}		-5		5	$^{\circ}K$
Drive Capability	I_{TM}		-100			μA
TM Output Setting	V_{TM}	Ambient Temperature = 300 $^{\circ}K$		3.00		V
Thermal Specification						
Junction Temperature Shutdown ^[a]	T_{MAX}		130	135	140	$^{\circ}C$
Junction-to-Case Thermal Impedance	θ_{J-C}			3		$^{\circ}C / W$
Case-to-Ambient Thermal Impedance	θ_{C-A}	Mounted on 9in ² 1oz. Cu 6 layer PCB 25 $^{\circ}C$		9.1		$^{\circ}C / W$
Soldering						
Peak Temperature During Reflow		MSL 5; time on floor = 48 hours			225	$^{\circ}C$
		MSL 6; time on floor = 4 hours			245	$^{\circ}C$
Regulatory Specification						
IEC 60950-1:2005 (2nd Edition)						
EN 60950-1:2006						
IEC 61000-4-2						
UL60950-1:2007						
CAN/CSA C22.2 NO. 60950-1-07						
Recommended Input Fuse Rating	I_{FUSE}	Fast acting LITTLEFUSE Nano ² Series Fuse	4		10	A

^[a] These parameters are not production tested but are guaranteed by design, characterization and correlation with statistical process control. Unless otherwise specified, ATE tests are completed at room temperature.

^[b] Current flow sourced by a pin has a negative sign.

PI3109-00-HVMZ Electrical Characteristics (Cont.)

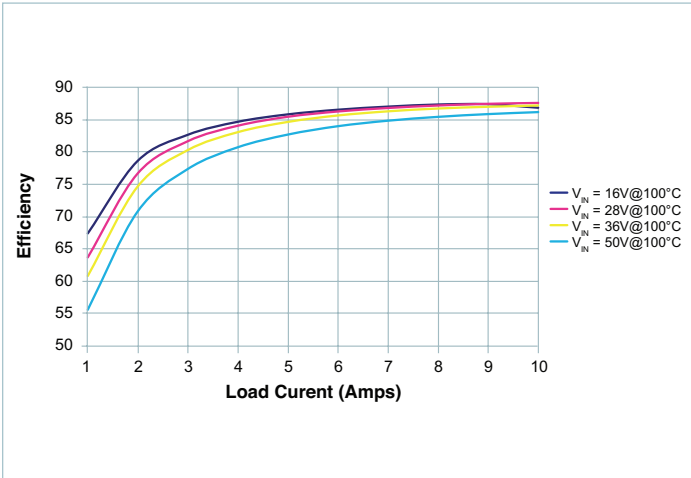

Figure 11 — Conversion efficiency

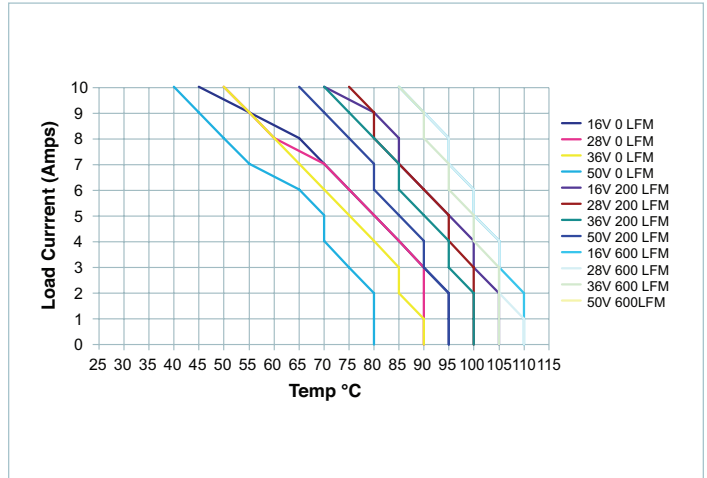

Figure 14 — Load current vs. temperature (11mm heat sink)

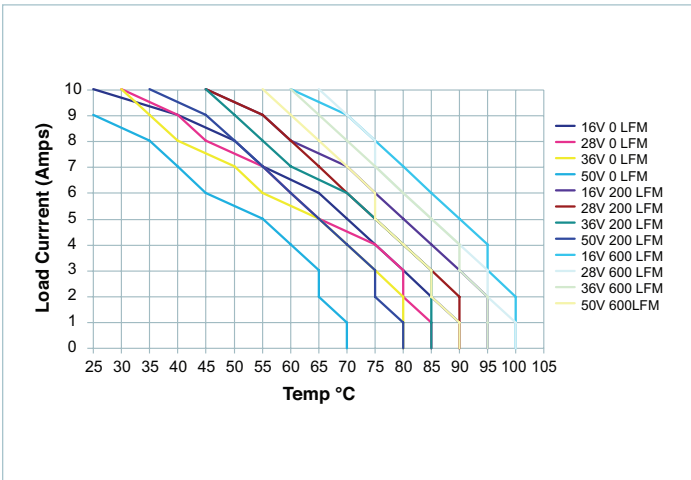

Figure 12 — Load current vs. temperature (without heat sink)

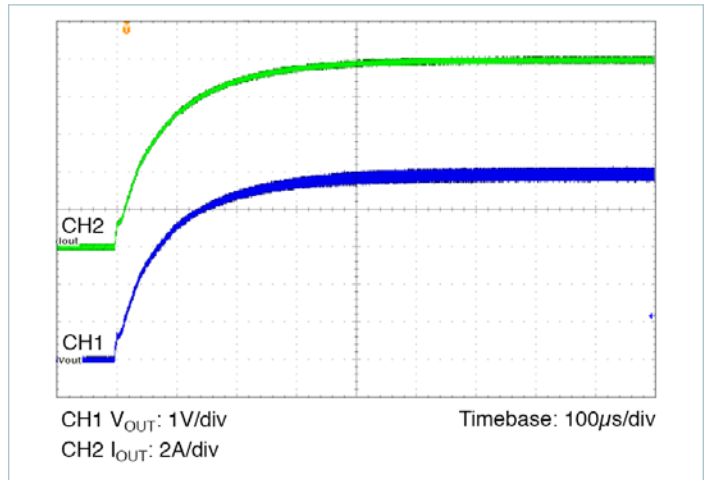

Figure 15 — Start up, $C_{REF} = 0$ ($V_{IN} = 16V$, $I_{OUT} = 10A$, C_R , $C_{OUT} = 6 \times 10\mu F$ X7R ceramic)

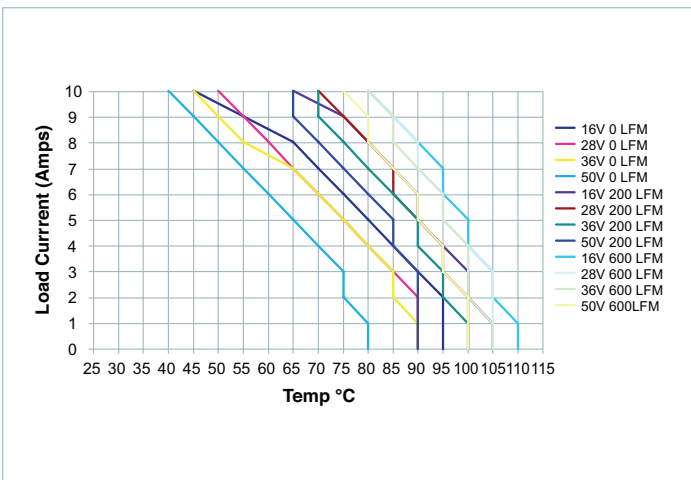

Figure 13 — Load current vs. temperature (6.33mm heat sink)

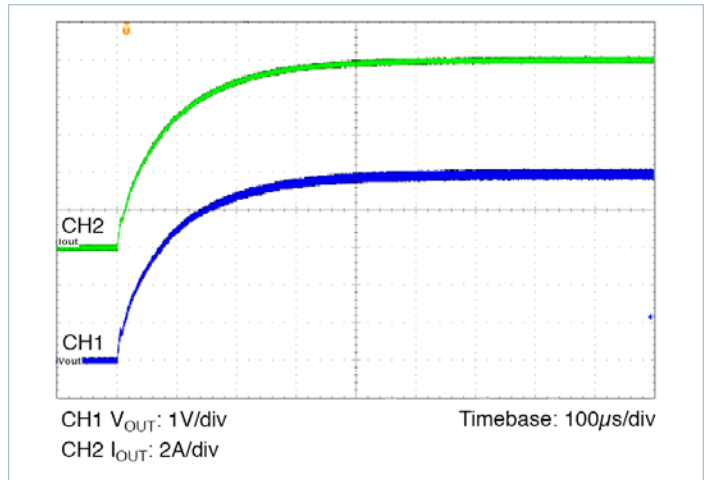

Figure 16 — Start up, $C_{REF} = 0$ ($V_{IN} = 28V$, $I_{OUT} = 10A$, C_R , $C_{OUT} = 6 \times 10\mu F$ X7R ceramic)

PI3109-00-HVMZ Electrical Characteristics (Cont.)

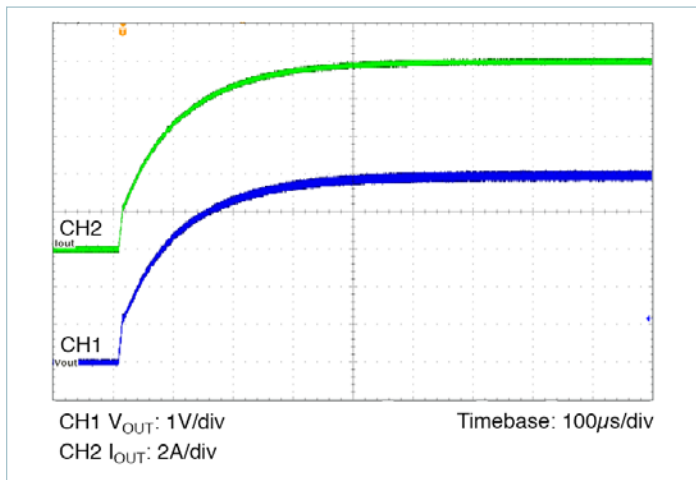

Figure 17 — Start up, $C_{REF} = 0$ ($V_{IN} = 50V$, $I_{OUT} = 10A$, CR, $C_{OUT} = 6 \times 10\mu F$ X7R ceramic)



Figure 20 — Thermal image ($V_{IN} = 28V$, $I_{OUT} = 10A$, CR, OLFM evaluation PCB)

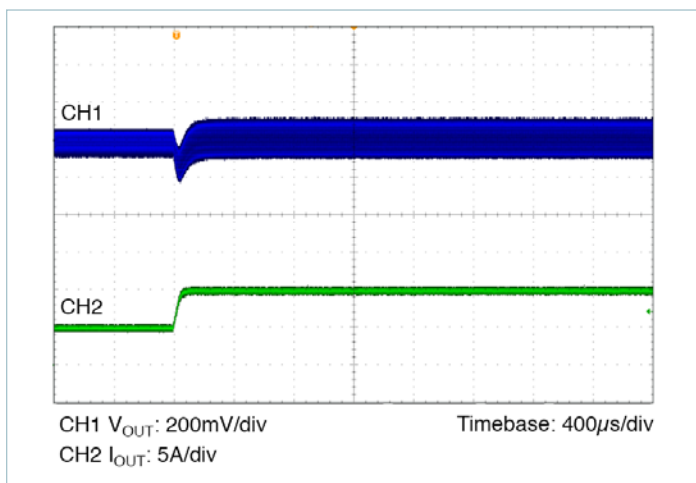

Figure 18 — Transient response ($V_{IN} = 28V$, $I_{OUT} = 5 - 10A$, $0.1A/\mu s$, $C_{OUT} = 6 \times 10\mu F$ X7R ceramic)

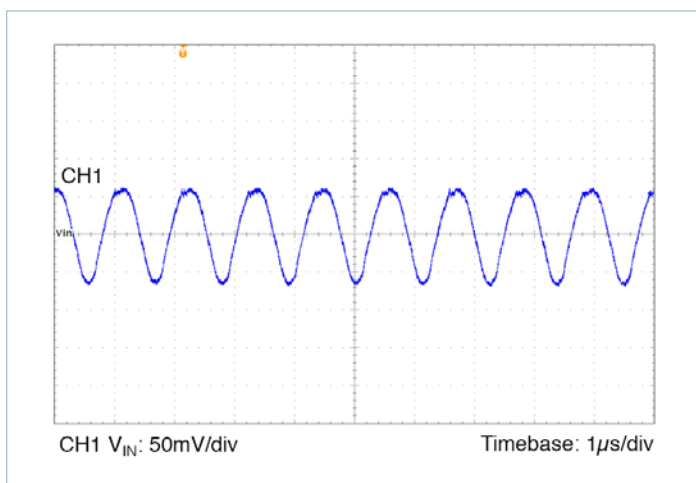

Figure 19 — Output ripple ($V_{IN} = 28V$, $I_{OUT} = 10A$, CR, $C_{OUT} = 6 \times 10\mu F$ X7R ceramic)

PI3106-00-HVMZ Electrical Characteristics

Unless otherwise specified: $16V < V_{IN} < 50V$, $0A < I_{OUT} < 4.2A$, $-55^{\circ}C < T_{CASE} < 100^{\circ}C$ [a]

Parameter	Symbol	Conditions	Min	Typ	Max	Unit
Input Specifications						
Input Voltage Range	V_{IN}		16	28	50	V_{DC}
Input dV/dt [a]	V_{INDVDT}	$V_{IN} = 50V$			1.0	$V/\mu s$
Input Undervoltage Turn-on	V_{UVON}	$I_O = 4.2A$	14.5	15.4	16	V_{DC}
Input Undervoltage Turn-off	V_{UVOFF}	$I_O = 4.2A$	13.5	14.4	15.2	V_{DC}
Input Undervoltage Hysteresis	V_{UVH}	$I_O = 4.2A$		1.0		V_{DC}
Input Overvoltage Turn-on	V_{OVON}	$I_O = 4.2A$	50	52.3	54	V_{DC}
Input Overvoltage Turn-off	V_{OVOFF}	$I_O = 4.2A$	51	53.5	55	V_{DC}
Input Overvoltage Hysteresis	V_{OVH}	$I_O = 4.2A$		1.2		V_{DC}
Input Quiescent Current	I_Q	$V_{IN} = 28V$, $ENABLE = 0V$		2		mA_{DC}
Input Idling Power	P_{IDLE}	$V_{IN} = 28V$, $I_{OUT} = 0A$		3.5		W
Input Standby Power	P_{SBY}	$V_{IN} = 28V$, $ENABLE = 0V$		0.056		W
Input Current Full Load	I_{IN}	$T_{CASE} = 100^{\circ}C$, $I_{OUT} = 4.2A$, $\eta_{FL} = 88\%$ typical, $V_{IN} = 28V$		2.045		A_{DC}
Input Reflected Ripple Current	I_{INRR}	$L_{IN} = 0.47\mu H$ $C_{IN} = 100\mu F$ 63V electrolytic + 2 x 4.7 μF 50V X7R ceramic		13		mApp
Recommended Ext Input Capacitance	C_{IN}	$C_{IN} = 100\mu F$ 63V electrolytic + 2 x 4.7 μF 50V X7R ceramic $C_{IN} = C_{bulk} + C_{hf}$		109.4		μF
Output Specifications						
Output Voltage Set Point	V_{OUT}	$I_{OUT} = 2.1A$		12.0		V_{DC}
Total Output Accuracy	V_{OA}	$-0^{\circ}C < T_{CASE} < 100^{\circ}C$	-3		+3	%
		$-55^{\circ}C < T_{CASE} < 0^{\circ}C$	-5		+3	%
Output Voltage Trim Range	V_{OAJD}		-20		10	%
Output Current Range	I_{OUT}				4.2	A_{DC}
Overcurrent Protection	I_{OCP}		4.6	6.8	12	A_{DC}
Efficiency – Full Load	η_{FL}	$T_{CASE} = 100^{\circ}C$, $V_{IN} = 28V$	86	88		%
Efficiency – Half Load	η_{HL}	$T_{CASE} = 100^{\circ}C$, $V_{IN} = 28V$	83	85		%
Output OVP Set Point	V_{OVP}		13.8	14.6	15.3	V_{DC}
Output Ripple Voltage	V_{ORPP}	$C_{OUT} = 6 \times 2.2\mu F$ 16V X7R DC-20MHz		150		mVpp
Switching Frequency	f_{SW}			900		kHz
Output Turn-on Delay Time	t_{ONDLY}	$V_{IN} = V_{UVON}$ to $ENABLE = 5V$; V_{IN} rise time < 1ms		80		ms
Output Turn-off Delay Time	t_{OFFDLY}	$V_{IN} = V_{UVOFF}$ to $ENABLE < 2.35V$		375		μs
Soft-Start Ramp Time	t_{SS}	$ENABLE = 5V$ to 90% V_{OUT} $C_{REF} = 0$		230		μs
Maximum Load Capacitance	C_{OUT}	$C_{REF} = 0.22\mu F$, $C_{OUT} = Al$ Electrolytic			1000	μF
Load Transient Deviation	V_{ODV}	$I_{OUT} = 50\%$ step $0.1A/\mu s$ $C_{OUT} = 6 \times 2.2\mu F$ 16V X7R		360		mV
Load Transient Recovery Time	t_{OVR}	$I_{OUT} = 50\%$ step $0.1A/\mu s$ $C_{OUT} = 6 \times 2.2\mu F$ 16V X7R $V_{OUT} \leq 1\%$		100		μs
Maximum Output Power	P_{OUT}			50		W
Absolute Maximum Output Ratings						
Name	Rating					
+OUT to -OUT	-0.5V to $16V_{DC}$					
Continuous Output Current	$4.2A_{DC}$					
Peak Output Current	$12A_{DC}$					

[a] These parameters are not production tested but are guaranteed by design, characterization and correlation with statistical process control. Unless otherwise specified, ATE tests are completed at room temperature.

[b] Current flow sourced by a pin has a negative sign.

PI3106-00-HVMZ Electrical Characteristics (Cont.)

Parameter	Symbol	Conditions	Min	Typ	Max	Unit
ENABLE						
DC Voltage Reference Output	V_{ERO}		4.65	4.9	5.15	V_{DC}
Output Current Limit ^[b]	I_{ECL}	ENABLE = 3.3V	-3.3	-2.6	-1.9	mA_{DC}
Start Up Current Limit ^[b]	I_{ESL}	ENABLE = 1V	-120	-90	-60	μA
Module Enable Voltage	V_{EME}		1.95	2.5	3.05	V_{DC}
Module Disable Voltage	V_{EMD}		1.8	2.35	2.9	V_{DC}
Disable Hysteresis	V_{EDH}			150		mV
Enable Delay Time	t_{EE}			10		μs
Disable Delay Time	t_{ED}			10		μs
Maximum Capacitance	C_{EC}				1500	pF
Maximum External Toggle Rate	f_{EXT}				1	Hz
TRIM/SS						
Trim Voltage Reference	V_{REF}			1.235		V_{DC}
Internal Capacitance	C_{REFI}			10		nF
External Capacitance	C_{REF}				0.22	μF
Internal Resistance	R_{REFI}			10		k Ω
TM (Temperature Monitor)						
Temperature Coefficient ^[a]	TM_{TC}			10		mV / $^{\circ}K$
Temperature Full Range Accuracy ^[a]	TM_{ACC}		-5		5	$^{\circ}K$
Drive Capability	I_{TM}		-100			μA
TM Output Setting	V_{TM}	Ambient Temperature = 300 $^{\circ}K$		3.00		V
Thermal Specification						
Junction Temperature Shutdown ^[a]	T_{MAX}		130	135	140	$^{\circ}C$
Junction-to-Case Thermal Impedance	θ_{J-C}			3		$^{\circ}C / W$
Case-to-Ambient Thermal Impedance	θ_{C-A}	Mounted on 9in ² 1oz. Cu 6 layer PCB 25 $^{\circ}C$		8.2		$^{\circ}C / W$
Soldering						
Peak Temperature During Reflow		MSL 5; time on floor = 48 hours			225	$^{\circ}C$
		MSL 6; time on floor = 4 hours			245	$^{\circ}C$
Regulatory Specification						
IEC 60950-1:2005 (2nd Edition)						
EN 60950-1:2006						
IEC 61000-4-2						
UL60950-1:2007						
CAN/CSA C22.2 NO. 60950-1-07						
Recommended Input Fuse Rating	I_{FUSE}	Fast acting LITTLEFUSE Nano ² Series Fuse	4		10	A

^[a] These parameters are not production tested but are guaranteed by design, characterization and correlation with statistical process control. Unless otherwise specified, ATE tests are completed at room temperature.

^[b] Current flow sourced by a pin has a negative sign.

PI3106-00-HVMZ Electrical Characteristics (Cont.)

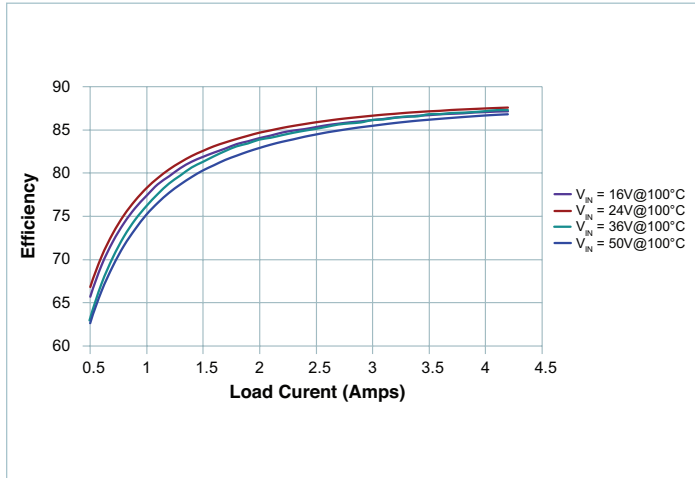

Figure 21 — Conversion efficiency

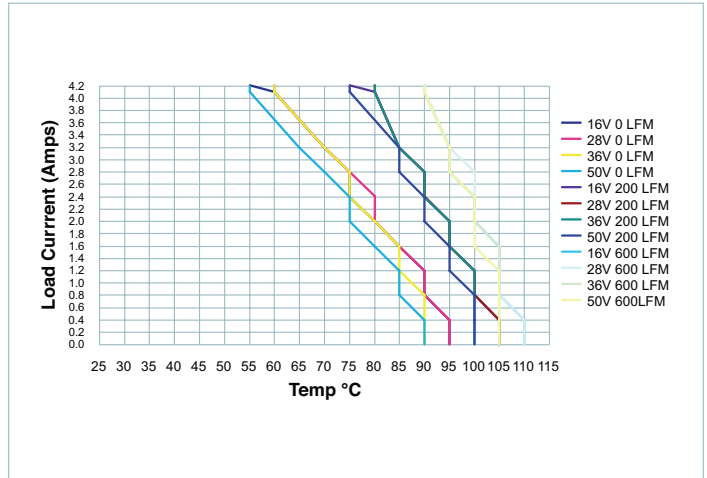

Figure 24 — Load current vs. temperature (11mm heat sink)

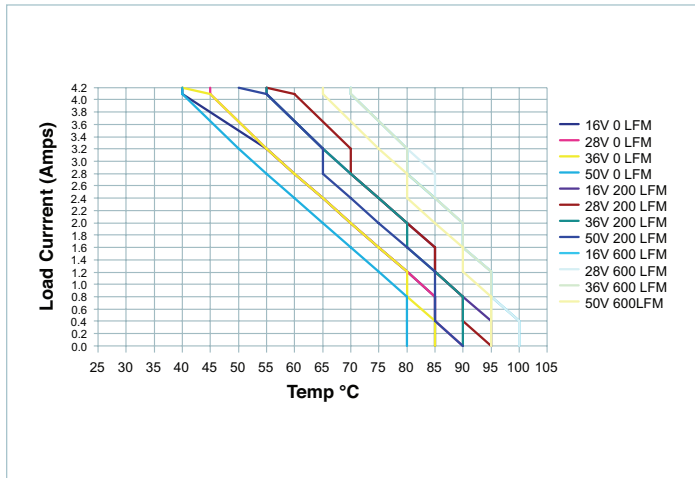

Figure 22 — Load current vs. temperature (without heat sink)

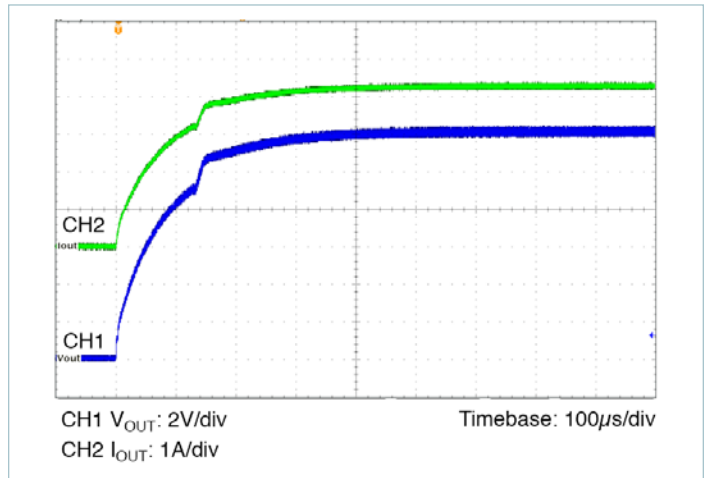

Figure 25 — Start up, $C_{REF} = 0$ ($V_{IN} = 16V$, $I_{OUT} = 4.2A$, C_R , $C_{OUT} = 6 \times 2.2\mu F$ X7R ceramic)

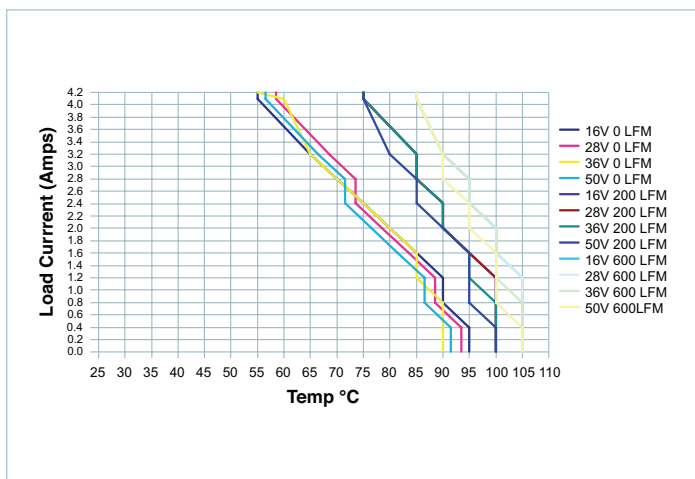

Figure 23 — Load current vs. temperature (6.3mm heat sink)

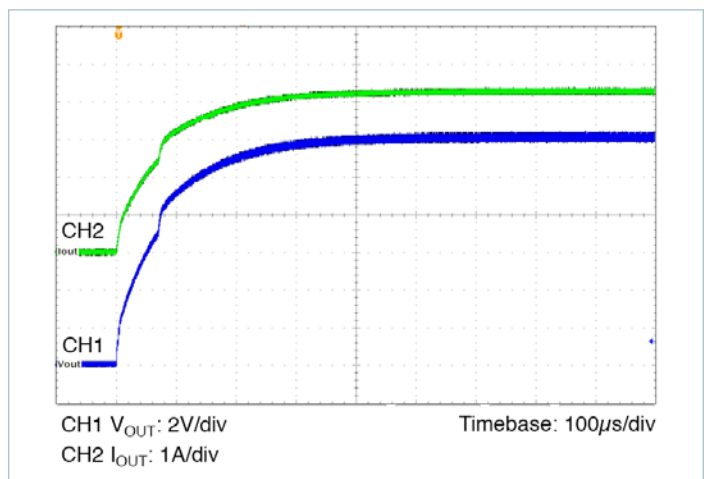

Figure 26 — Start up, $C_{REF} = 0$ ($V_{IN} = 28V$, $I_{OUT} = 4.2A$, C_R , $C_{OUT} = 6 \times 2.2\mu F$ X7R ceramic)

PI3106-00-HVMZ Electrical Characteristics (Cont.)

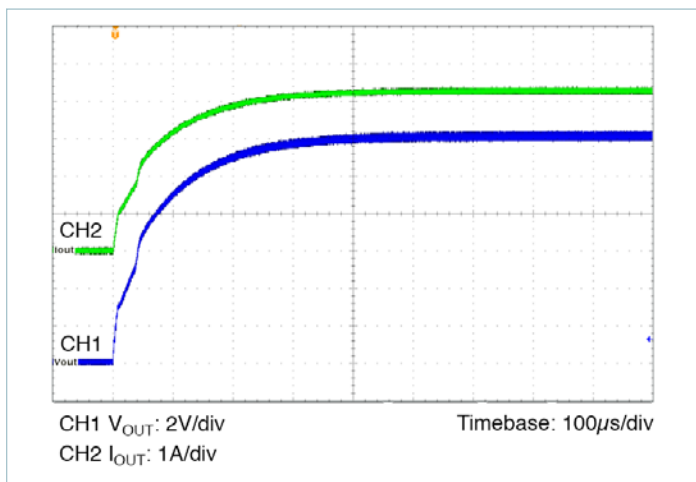

Figure 27 — Start up, $C_{REF} = 0$ ($V_{IN} = 50V$, $I_{OUT} = 4.2A$, $C_{OUT} = 6 \times 2.2\mu F$ X7R ceramic)

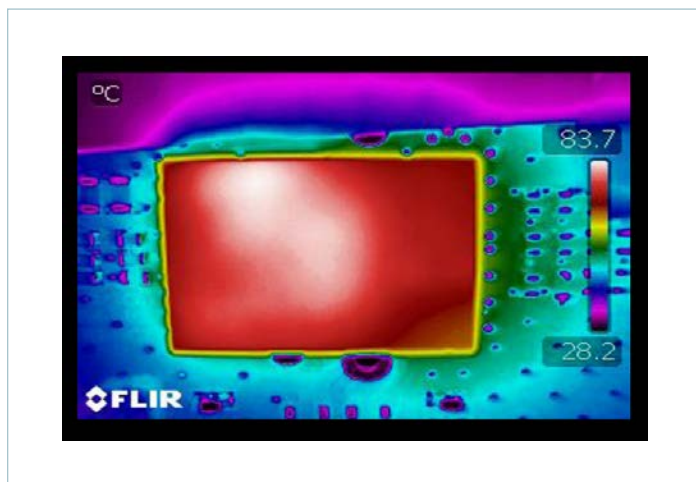

Figure 30 — Thermal image ($V_{IN} = 28V$, $I_{OUT} = 4.2A$, CR, OLFM evaluation PCB)

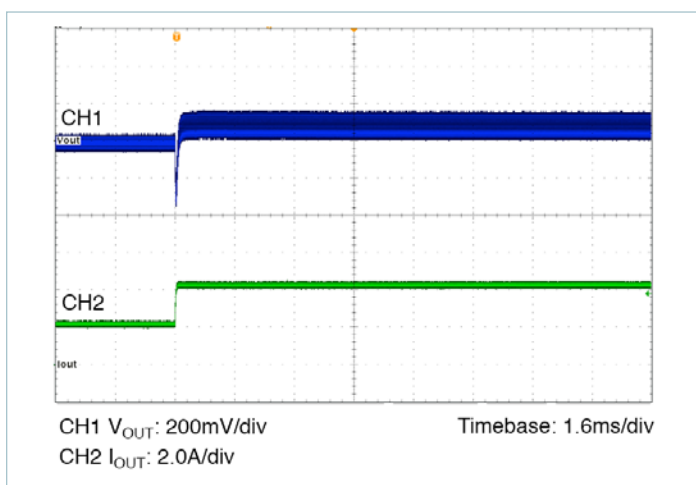

Figure 28 — Transient response ($V_{IN} = 28V$, $I_{OUT} = 2.1 - 4.2A$, $0.1A/\mu s$, $C_{OUT} = 6 \times 2.2\mu F$ X7R ceramic)

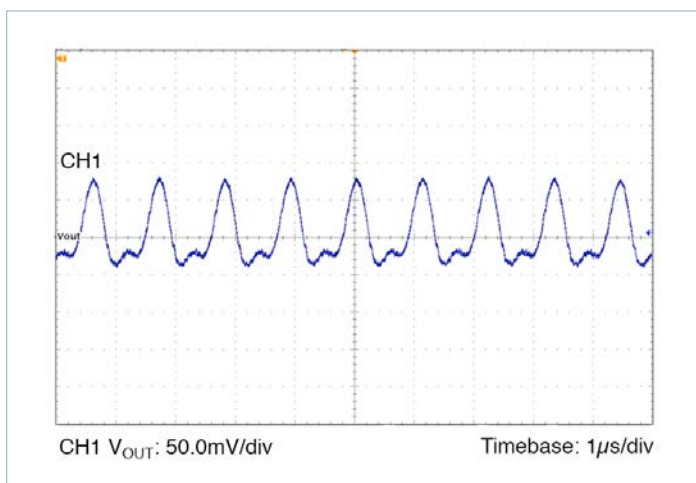

Figure 29 — Output ripple ($V_{IN} = 28V$, $I_{OUT} = 4.2A$, $C_{OUT} = 6 \times 2.2\mu F$ X7R ceramic)

PI3111-00-HVMZ Electrical Characteristics

Unless otherwise specified: $16V < V_{IN} < 50V$, $0A < I_{OUT} < 3.3A$, $-55^{\circ}C < T_{CASE} < 100^{\circ}C$ [a]

Parameter	Symbol	Conditions	Min	Typ	Max	Unit
Input Specifications						
Input Voltage Range	V_{IN}		16	28	50	V_{DC}
Input dV/dt [a]	V_{INDVDT}	$V_{IN} = 50V$			1.0	$V/\mu s$
Input Undervoltage Turn-on	V_{UVON}	$I_O = 3.3A$	14.5	15.4	16	V_{DC}
Input Undervoltage Turn-off	V_{UVOFF}	$I_O = 3.3A$	13.5	14.3	15.2	V_{DC}
Input Undervoltage Hysteresis	V_{UVH}	$I_O = 3.3A$		1.1		V_{DC}
Input Overvoltage Turn-on	V_{OVON}	$I_O = 3.3A$	50	52.4	54	V_{DC}
Input Overvoltage Turn-off	V_{OVOFF}	$I_O = 3.3A$	51	53.5	55	V_{DC}
Input Overvoltage Hysteresis	V_{OVH}	$I_O = 3.3A$		1.1		V_{DC}
Input Quiescent Current	I_Q	$V_{IN} = 28V$, $ENABLE = 0V$		2		mA_{DC}
Input Idling Power	P_{IDLE}	$V_{IN} = 28V$, $I_{OUT} = 0A$		4.1		W
Input Standby Power	P_{SBY}	$V_{IN} = 28V$, $ENABLE = 0V$		0.056		W
Input Current Full Load	I_{IN}	$T_{CASE} = 100^{\circ}C$, $I_{OUT} = 3.3A$, $\eta_{FL} = 87.5\%$ typical, $V_{IN} = 28V$		2.039		A_{DC}
Input Reflected Ripple Current	I_{INRR}	$L_{IN} = 0.47\mu H$ $C_{IN} = 100\mu F$ 63V electrolytic + 2 x 4.7 μF 50V X7R ceramic		13		mApp
Recommended Ext Input Capacitance	C_{IN}	$C_{IN} = 100\mu F$ 63V electrolytic + 2 x 4.7 μF 50V X7R ceramic $C_{IN} = C_{bulk} + C_{hf}$		109.4		μF
Output Specifications						
Output Voltage Set Point	V_{OUT}	$I_{OUT} = 1.65A$		15.0		V_{DC}
Total Output Accuracy	V_{OA}	$-0^{\circ}C < T_{CASE} < 100^{\circ}C$	-3		+3	%
		$-55^{\circ}C < T_{CASE} < 0^{\circ}C$	-5		+3	%
Output Voltage Trim Range	V_{OAdj}		-20		10	%
Output Current Range	I_{OUT}				3.3	A_{DC}
Overcurrent Protection	I_{OCP}		3.8	5.6	9.6	A_{DC}
Efficiency – Full Load	η_{FL}	$T_{CASE} = 100^{\circ}C$, $V_{IN} = 28V$	85.5	87.5		%
Efficiency – Half Load	η_{HL}	$T_{CASE} = 100^{\circ}C$, $V_{IN} = 28V$	82.3	84.3		%
Output OVP Set Point	V_{OVP}		17.6	18.2	18.8	V_{DC}
Output Ripple Voltage	V_{ORPP}	$C_{OUT} = 6 \times 2.2\mu F$ 16V X7R DC-20MHz		275		mVpp
Switching Frequency	f_{SW}			900		kHz
Output Turn-on Delay Time	t_{ONDLY}	$V_{IN} = V_{UVON}$ to $ENABLE = 5V$; V_{IN} rise time < 1ms		80		ms
Output Turn-off Delay Time	t_{OFFDLY}	$V_{IN} = V_{UVOFF}$ to $ENABLE < 2.35V$		375		μs
Soft-Start Ramp Time	t_{SS}	$ENABLE = 5V$ to 90% V_{OUT} $C_{REF} = 0$		230		μs
Maximum Load Capacitance	C_{OUT}	$C_{REF} = 0.22\mu F$, $C_{OUT} = Al$ Electrolytic			1000	μF
Load Transient Deviation	V_{ODV}	$I_{OUT} = 50\%$ step $0.1A/\mu s$ $C_{OUT} = 6 \times 2.2\mu F$ 16V X7R		375		mV
Load Transient Recovery Time	t_{OVR}	$I_{OUT} = 50\%$ step $0.1A/\mu s$ $C_{OUT} = 6 \times 2.2\mu F$ 16V X7R $V_{OUT} \leq 1\%$		100		μs
Maximum Output Power	P_{OUT}			50		W
Absolute Maximum Output Ratings						
Name	Rating					
+OUT to -OUT	-0.5V to $20V_{DC}$					
Continuous Output Current	$3.3A_{DC}$					
Peak Output Current	$9.6A_{DC}$					

[a] These parameters are not production tested but are guaranteed by design, characterization and correlation with statistical process control. Unless otherwise specified, ATE tests are completed at room temperature.

[b] Current flow sourced by a pin has a negative sign.

PI3111-00-HVMZ Electrical Characteristics (Cont.)

Parameter	Symbol	Conditions	Min	Typ	Max	Unit
ENABLE						
DC Voltage Reference Output	V_{ERO}		4.65	4.9	5.15	V_{DC}
Output Current Limit ^[b]	I_{ECL}	ENABLE = 3.3V	-3.3	-2.6	-1.9	mA_{DC}
Start Up Current Limit ^[b]	I_{ESL}	ENABLE = 1V	-120	-90	-60	μA
Module Enable Voltage	V_{EME}		1.95	2.5	3.05	V_{DC}
Module Disable Voltage	V_{EMD}		1.8	2.35	2.9	V_{DC}
Disable Hysteresis	V_{EDH}			150		mV
Enable Delay Time	t_{EE}			10		μs
Disable Delay Time	t_{ED}			10		μs
Maximum Capacitance	C_{EC}				1500	pF
Maximum External Toggle Rate	f_{EXT}				1	Hz
TRIM/SS						
Trim Voltage Reference	V_{REF}			1.230		V_{DC}
Internal Capacitance	C_{REFI}			10		nF
External Capacitance	C_{REF}				0.22	μF
Internal Resistance	R_{REFI}			10		k Ω
TM (Temperature Monitor)						
Temperature Coefficient ^[a]	TM_{TC}			10		mV / $^{\circ}K$
Temperature Full Range Accuracy ^[a]	TM_{ACC}		-5		5	$^{\circ}K$
Drive Capability	I_{TM}		-100			μA
TM Output Setting	V_{TM}	Ambient Temperature = 300 $^{\circ}K$		3.00		V
Thermal Specification						
Junction Temperature Shutdown ^[a]	T_{MAX}		130	135	140	$^{\circ}C$
Junction-to-Case Thermal Impedance	θ_{J-C}			3		$^{\circ}C / W$
Case-to-Ambient Thermal Impedance	θ_{C-A}	Mounted on 9in ² 1oz. Cu 6 layer PCB 25 $^{\circ}C$		9.4		$^{\circ}C / W$
Soldering						
Peak Temperature During Reflow		MSL 5; time on floor = 48 hours			225	$^{\circ}C$
		MSL 6; time on floor = 4 hours			245	$^{\circ}C$
Regulatory Specification						
IEC 60950-1:2005 (2nd Edition)						
EN 60950-1:2006						
IEC 61000-4-2						
UL60950-1:2007						
CAN/CSA C22.2 NO. 60950-1-07						
Recommended Input Fuse Rating	I_{FUSE}	Fast acting LITTLEFUSE Nano ² Series Fuse	4		10	A

^[a] These parameters are not production tested but are guaranteed by design, characterization and correlation with statistical process control. Unless otherwise specified, ATE tests are completed at room temperature.

^[b] Current flow sourced by a pin has a negative sign.

PI3111-00-HVMZ Electrical Characteristics (Cont.)

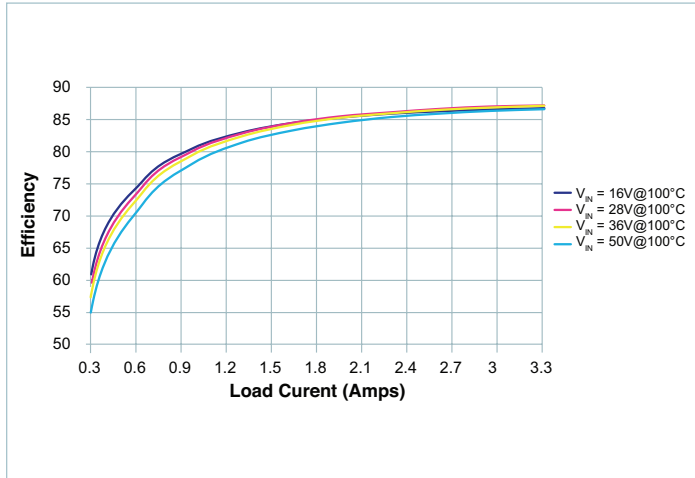

Figure 31 — Conversion efficiency

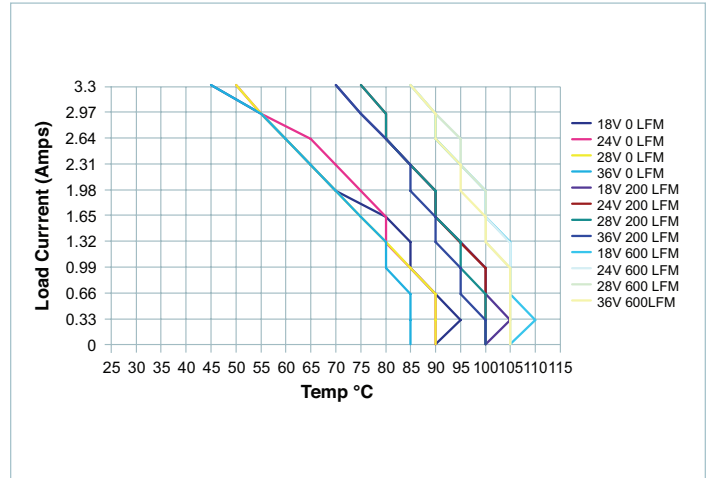

Figure 34 — Load current vs. temperature (11mm heat sink)

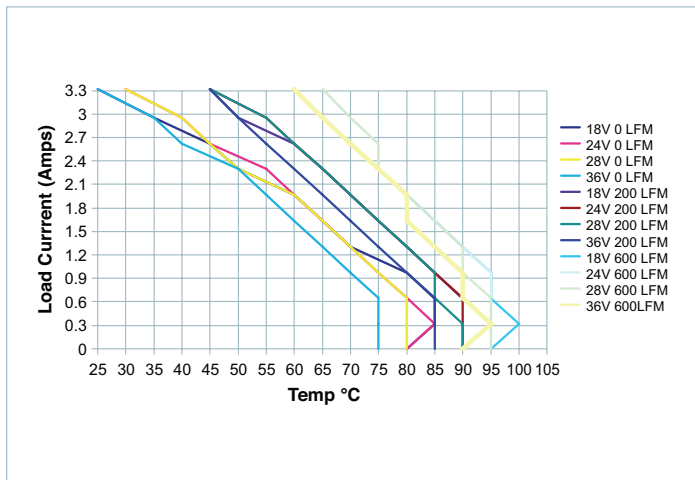

Figure 32 — Load current vs. temperature (without heat sink)

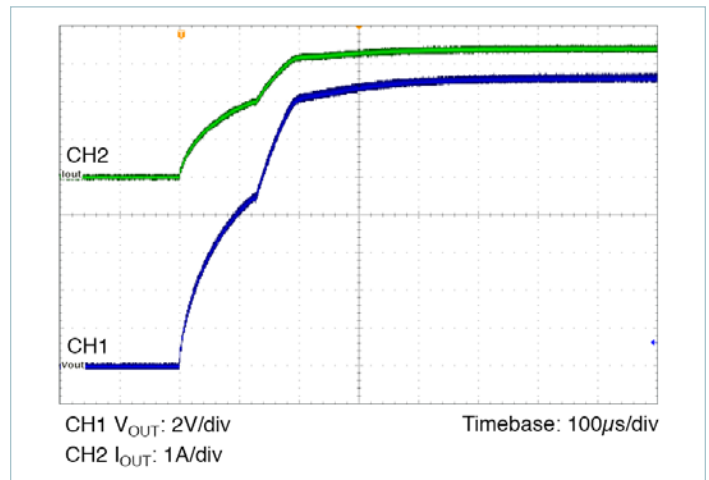

Figure 35 — Start up, $C_{REF} = 0$ ($V_{IN} = 16V$, $I_{OUT} = 3.3A$, C_R , $C_{OUT} = 6 \times 2.2\mu F$ X7R ceramic)

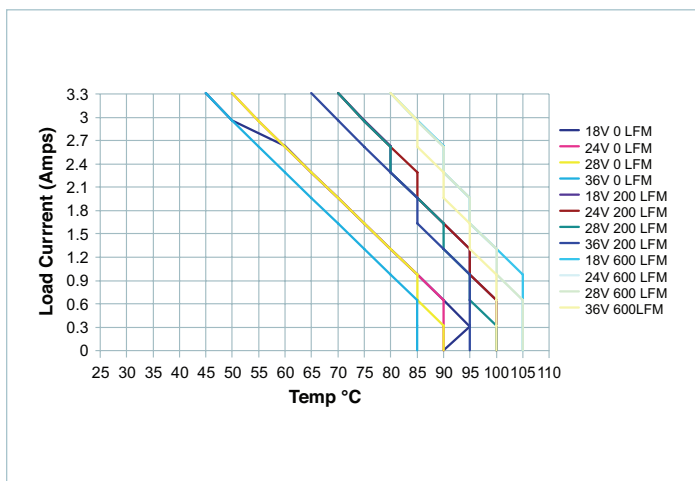

Figure 33 — Load current vs. temperature (6.33mm heat sink)

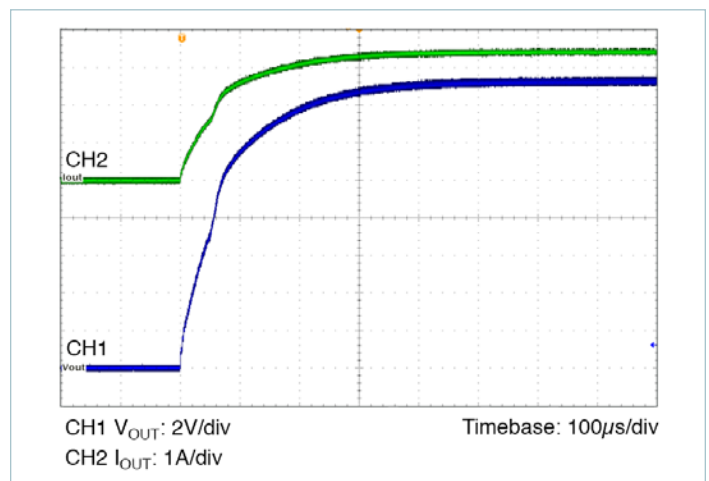

Figure 36 — Start up, $C_{REF} = 0$ ($V_{IN} = 28V$, $I_{OUT} = 3.3A$, C_R , $C_{OUT} = 6 \times 2.2\mu F$ X7R ceramic)

PI3111-00-HVMZ Electrical Characteristics (Cont.)

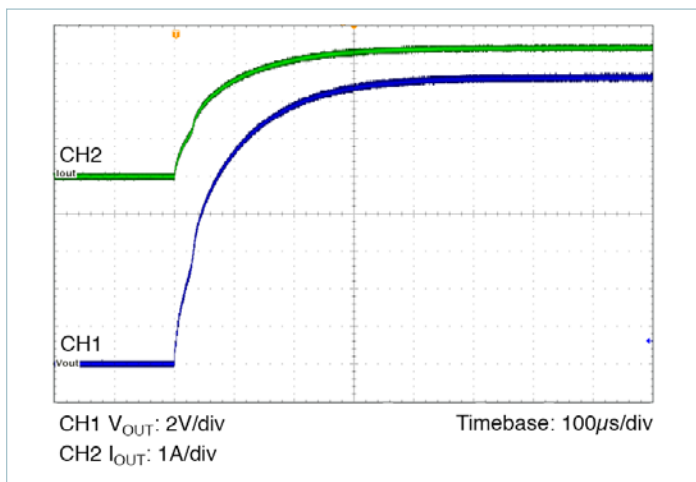

Figure 37 — Start up, $C_{REF} = 0$ ($V_{IN} = 50V$, $I_{OUT} = 3.3A$, CR, $C_{OUT} = 6 \times 2.2\mu F$ X7R ceramic)



Figure 40 — Thermal image ($V_{IN} = 28V$, $I_{OUT} = 3.33A$, CR, OLFM Evaluation PCB)

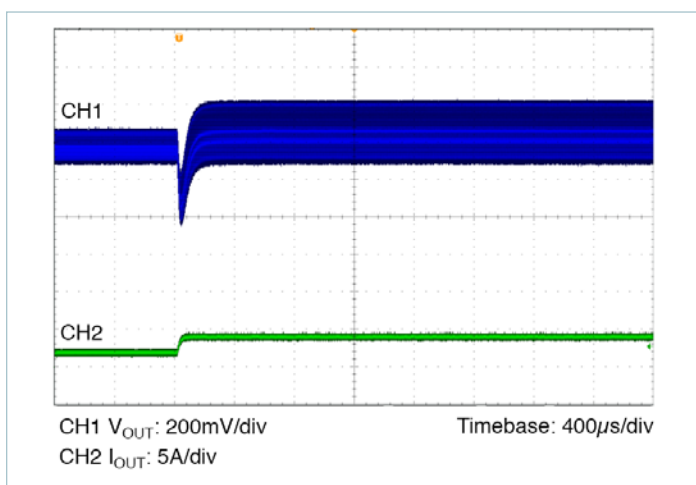

Figure 38 — Transient response ($V_{IN} = 28V$, $I_{OUT} = 1.65 - 3.3A$, $0.1A/\mu s$, $C_{OUT} = 6 \times 2.2\mu F$ X7R ceramic)

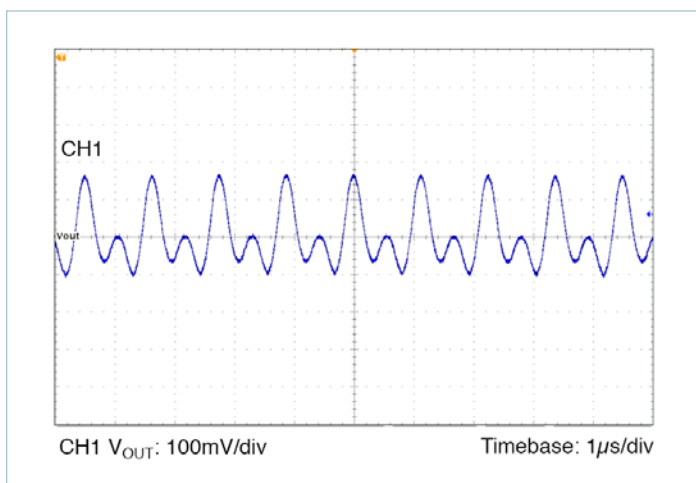

Figure 39 — Output ripple ($V_{IN} = 28V$, $I_{OUT} = 3.3A$, $C_{OUT} = 6 \times 2.2\mu F$ X7R ceramic)

Functional Description

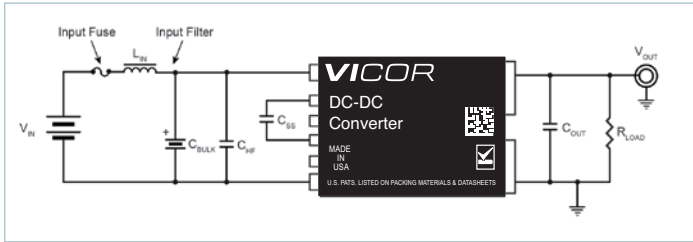

Figure 41 — PI31xx-00-HVMZ shown with system fuse, filter, decoupling and extended soft start

Input Power Pins IN(+) and IN(-)

The input power pins on the PI31xx-00-HVMZ are connected to the input power source which can range from 16 – 50V_{DC}. Under surge conditions, the PI31xx-00-HVMZ can withstand up to 55V_{DC} for 12.5ms without incurring damage. The user should take care to avoid driving the input rails above the specified ratings. Since the PI31xx-00-HVMZ is designed with high reliability in mind, the input pins are continuously monitored. If the applied voltage exceeds the input overvoltage trip point (typically 53.5V) the conversion process shall be terminated immediately. The converter initiates soft start automatically within 80ms after the input voltage is reduced back to the appropriate value. The input pins do not have reverse-polarity protection. If the PI31xx-00-HVMZ is operated in an environment where reverse polarity is a concern, the user should consider using a polarity protection device such as a suitably rated diode. To avoid the high losses of using a diode, the user should consider the much higher efficiency family of intelligent Cool-ORing[®] solutions that can be used in reverse-polarity applications. Information is available at vicorpower.com.

The PI31xx-00-HVMZ will draw nearly zero current until the input voltage reaches the internal start up threshold. If the ENABLE pin is not pulled low by external circuitry, the output voltage will begin rising to its final output value about 80ms after the input UV lockout releases. This will occur automatically even if the ENABLE pin is floating.

To help keep the source impedance low, the input to the PI31xx-00-HVMZ should be bypassed with (2) 4.7μF 50V ceramic capacitors of X7R dielectric in parallel with a low Q 100μF 63V electrolytic capacitor. To reduce EMI and reflected ripple current, a series inductor of 0.2 – 0.47μH can be added. The input traces to the module should be low impedance configured in such a manner as to keep stray inductance minimized.

ENABLE

The ENABLE pin serves as a multi-function pin for the PI31xx-00-HVMZ. During normal operation, it outputs the on-board 4.9V regulator which can be used for trimming the module up. The ENABLE pin can also be used as a remote enable pin either from the secondary via an optocoupler and an external isolated bias supply or from the primary side through a small-signal transistor, FET, or any device that sinks 3.3mA, minimum.

If the ENABLE pin is lower than 2.35V typical, the converter will be held off or shut down if already operating. A third feature is offered in that during a fault condition, such as output OVP, input UV or OV, or output current limit, the ENABLE pin is pulled low internally. This can be used as a signal to the user that a fault has occurred. Whenever the ENABLE pin is pulled low, the TRIM/SS pin follows, resetting the internal and external soft-start circuitry. All faults will pull ENABLE low including overtemperature. If increased turn-on delay is desired, the ENABLE pin can be bypassed with a small capacitor up to a maximum of 1500pF.

TRIM/SS Pin

The TRIM/SS pin serves as another multi-purpose pin. First, it is used as the reference for the internal error amplifier. Connecting a resistor from TRIM/SS to SGND allows the reference to be margined down by as much as –20%. Connecting a resistor from TRIM/SS to ENABLE will allow the reference and output voltage to be margined up by 10%. If the user wishes a longer start up time, a small ceramic capacitor can be added to TRIM/SS to increase it. It is critical to connect any device between TRIM/SS and SGND and not –IN, otherwise high frequency noise will be introduced to the reference and possibly cause erratic operation. Referring to the figures below, the appropriate trim up or trim-down resistor can be calculated using the equivalent circuit diagram and the equations. When trimming up, the trim-down resistor is not populated. When trimming down, the trim-up resistor is not populated. The soft-start time is adjustable and has a default value of 500μs to reach steady state. The internal soft-start capacitor value is 10nF.

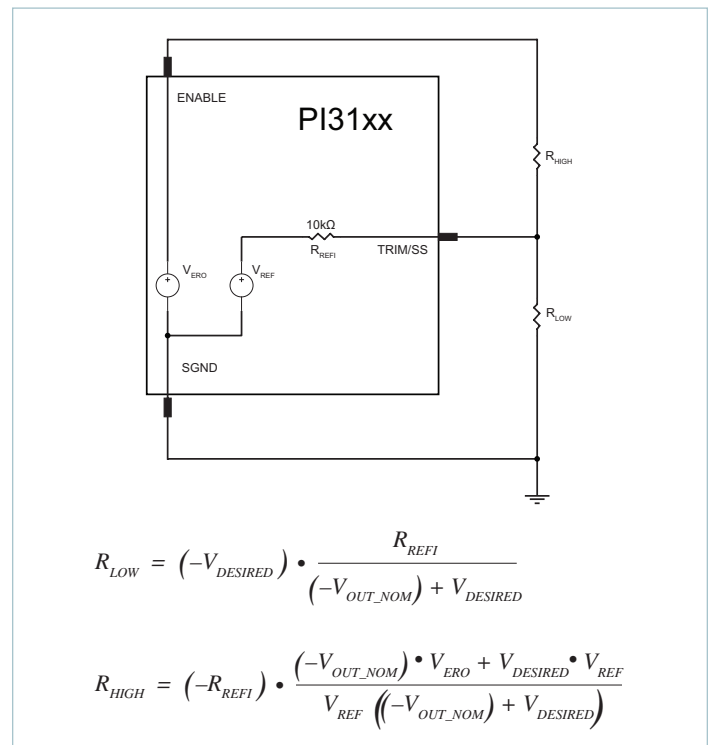

Figure 42 — Trim equations and equivalent circuit

$$C_{REF} = \frac{T_{SS_DESIRED} - 230 \cdot 10^{-6}}{23000}$$

TM

The TM pin serves as an output indicator of the internal package temperature which is within $\pm 5^{\circ}\text{K}$ of the hottest junction temperature. Because of this, it is a good indicator of a thermal overload condition. The output is a scaled, buffered analog voltage which indicates the internal temperature in degrees Kelvin. Upon a thermal overload, the TM pin is pulled low, indicating a thermal fault has occurred. Upon restart of the converter, the TM pin reverts back to a buffered monitor. The thermal shutdown function of the PI31xx-00-HVMZ is a fault feature which interrupts power processing if a certain maximum temperature is exceeded. TM can be monitored by an external microcontroller or circuit configured as an adaptive fan speed controller so that air flow in the system can be conveniently regulated.

SGND

The PI31xx-00-HVMZ SGND pin is the “quiet” control circuitry return. It is basically an extension of the internal signal ground. To avoid contamination and potential ground loops, this ground should NOT be connected to –IN since it is already star connected inside the package. Connect signal logic to SGND.

Output Power Pins +OUT and –OUT

The output power terminals OUT(+) and OUT(–) deliver the maximum output current from the PI31xx-00-HVMZ through the J-lead output pins. This configuration allows for a low impedance output and should be connected to multi-layer PCB parallel planes for best performance. Due to the high switching frequency, output ripple and noise can be easily attenuated by adding just a few high-quality X7R ceramic capacitors while retaining adequate transient response for most applications. The PI31xx-00-HVMZ does not require any feedback loop compensation nor does it require any opto-isolation. All isolation is contained within the package. This greatly simplifies the use of the converter and eliminates all outside influences of noise on the quality of the output voltage regulation and feedback loop. It is important for the user to minimize resistive connections from the load to the converter output and to keep stray inductance to a minimum for best regulation and transient response. The very small size footprint and height of the PI31xx-00-HVMZ allows the converter to be placed in the optimum location to allow for tight connections to the point-of-load.

Package Outline & Recommended PCB Land Pattern

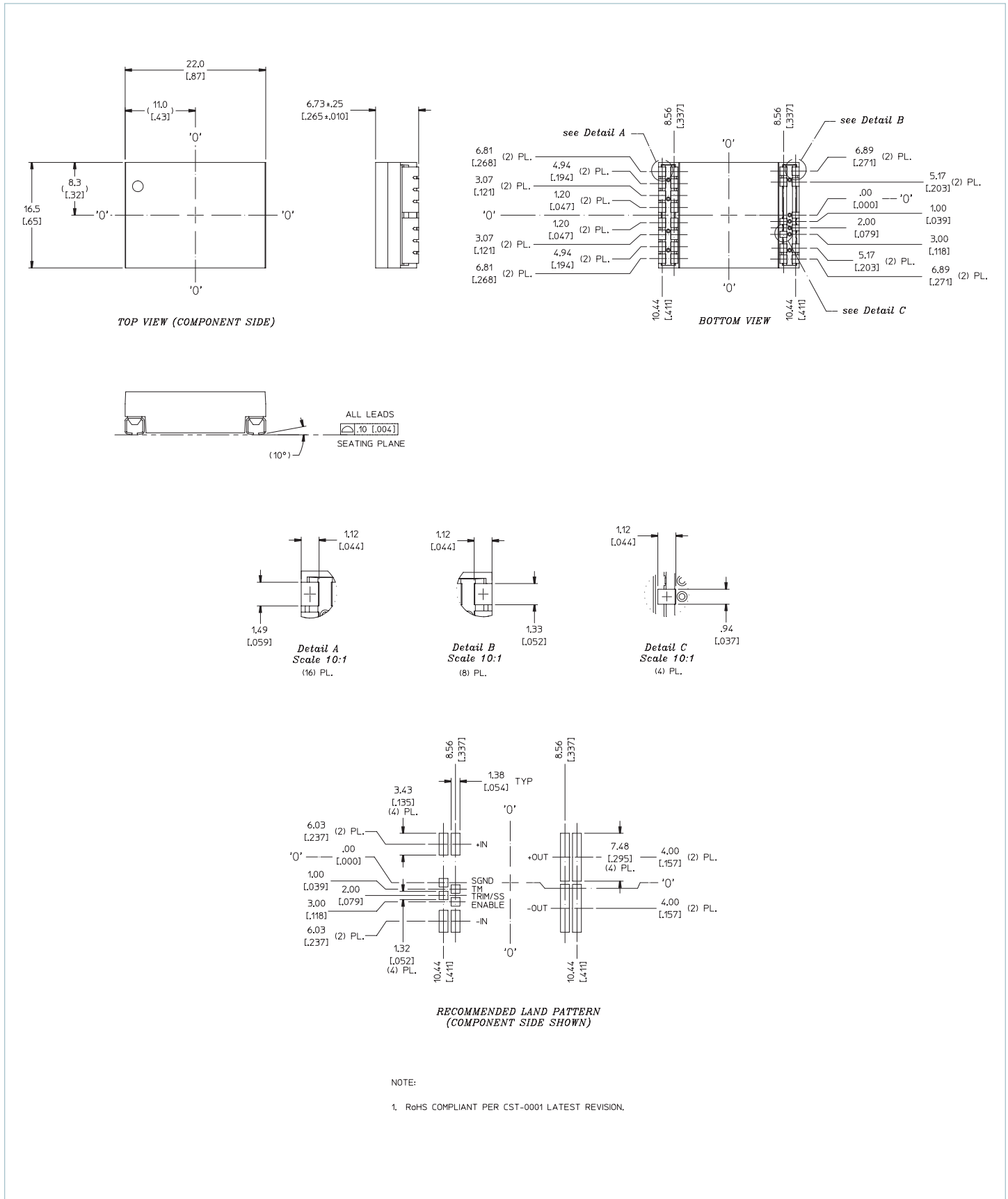

Figure 43 — Package outline & recommended PCB land pattern

Vicor's comprehensive line of power solutions includes high density AC-DC and DC-DC modules and accessory components, fully configurable AC-DC and DC-DC power supplies, and complete custom power systems.

Information furnished by Vicor is believed to be accurate and reliable. However, no responsibility is assumed by Vicor for its use. Vicor makes no representations or warranties with respect to the accuracy or completeness of the contents of this publication. Vicor reserves the right to make changes to any products, specifications, and product descriptions at any time without notice. Information published by Vicor has been checked and is believed to be accurate at the time it was printed; however, Vicor assumes no responsibility for inaccuracies. Testing and other quality controls are used to the extent Vicor deems necessary to support Vicor's product warranty. Except where mandated by government requirements, testing of all parameters of each product is not necessarily performed.

Specifications are subject to change without notice.

Visit <http://www.vicorpower.com/pi31xx-isolated-regulated-dc-dc-converter> for the latest product information.

Vicor's Standard Terms and Conditions and Product Warranty

All sales are subject to Vicor's Standard Terms and Conditions of Sale, and Product Warranty which are available on Vicor's webpage (<http://www.vicorpower.com/termsconditionswarranty>) or upon request.

Life Support Policy

VICOR'S PRODUCTS ARE NOT AUTHORIZED FOR USE AS CRITICAL COMPONENTS IN LIFE SUPPORT DEVICES OR SYSTEMS WITHOUT THE EXPRESS PRIOR WRITTEN APPROVAL OF THE CHIEF EXECUTIVE OFFICER AND GENERAL COUNSEL OF VICOR CORPORATION. As used herein, life support devices or systems are devices which (a) are intended for surgical implant into the body, or (b) support or sustain life and whose failure to perform when properly used in accordance with instructions for use provided in the labeling can be reasonably expected to result in a significant injury to the user. A critical component is any component in a life support device or system whose failure to perform can be reasonably expected to cause the failure of the life support device or system or to affect its safety or effectiveness. Per Vicor Terms and Conditions of Sale, the user of Vicor products and components in life support applications assumes all risks of such use and indemnifies Vicor against all liability and damages.

Intellectual Property Notice

Vicor and its subsidiaries own Intellectual Property (including issued U.S. and Foreign Patents and pending patent applications) relating to the products described in this data sheet. No license, whether express, implied, or arising by estoppel or otherwise, to any intellectual property rights is granted by this document. Interested parties should contact Vicor's Intellectual Property Department.

The products described on this data sheet are protected by U.S. Patents. Please see www.vicorpower.com/patents for the latest patent information.

Contact Us: <http://www.vicorpower.com/contact-us>

Vicor Corporation
25 Frontage Road
Andover, MA, USA 01810
Tel: 800-735-6200
Fax: 978-475-6715
www.vicorpower.com

email

Customer Service: custserv@vicorpower.com
Technical Support: apps@vicorpower.com