

C027-C20/U20/G35

mbed enabled Internet of Things (IoT) starter kit

User Guide

Abstract

This user guide explains how to set up the C027 starter kit to begin developing Internet of Things applications for the u-blox LISA-U200, LISA-C200 or SARA-G350 cellular and MAX-M8 positioning modules.



Document Information

Title	C027-C20/U20/G35		
Subtitle	mbed enabled Internet of Things (IoT) starter kit		
Document type	User Guide		
Document number	UBX-13004386		
Revision, date	R03	07-Nov-2015	
Document status	Early Production Information		

Document status explanation

Objective Specification	Document contains target values. Revised and supplementary data will be published later.		
Advance Information	Document contains data based on early testing. Revised and supplementary data will be published later.		
Early Production Information	Document contains data from product verification. Revised and supplementary data may be published later.		
Production Information	Document contains the final product specification.		

This document applies to the following products:

Name	Type number	Firmware version	PCN / IN
C027-C20	C027-C20-0-02	N/A	N/A
C027-C20	C027-C20-1-02	N/A	N/A
C027-U20	C027-U20-0-02	N/A	N/A
C027-G35	C027-G35-0-02	N/A	N/A

This document and the use of any information contained therein, is subject to the acceptance of the u-blox terms and conditions. They can be downloaded from www.u-blox.com.

u-blox makes no warranties based on the accuracy or completeness of the contents of this document and reserves the right to make changes to specifications and product descriptions at any time without notice.

u-blox reserves all rights to this document and the information contained herein. Reproduction, use or disclosure to third parties without express permission is strictly prohibited. Copyright © 2015, u-blox AG.

Trademark Notice

u-blox® is a registered trademark of u-blox Holding AG in the EU and other countries.

ARM® is the registered trademark of ARM Limited in the EU and other countries.

Microsoft and Windows are either registered trademarks or trademarks of Microsoft Corporation in the United States and/or other countries. All other registered trademarks or trademarks mentioned in this document are property of their respective owners.



Contents

Contents.....	3
1 Starting up.....	4
1.1 C027-C20/U20/G35 pin definition.....	5
1.2 C027-C20/U20/G35 block diagram	6
1.3 C027 starter kit BoM	6
1.4 Features.....	6
1.4.1 Cellular and GNSS modules	6
1.4.2 Main CPU.....	6
1.4.3 Interfaces and electrical data	6
1.5 C027-C20/U20/G35 connectors	7
1.6 LEDs	7
2 Getting started with mbed.....	8
2.1 Board setup and settings	8
2.2 Board power supply.....	8
2.3 Windows serial configuration	8
2.4 Board interface settings	8
2.5 Flashing the ARM-Cortex M0 LPC11U35 MCU	8
2.6 Getting started with mbed	8
3 Cloud services and analytics.....	9
Related documents	10
Revision history.....	10
Contact.....	11

1 Starting up

The C027 is a complete starter kit that allows quick prototyping of a variety of applications for the Internet of Things. The application board has a MAX-M8 GNSS receiver and a LISA-U200, LISA-C200 or SARA-G350 cellular module, enabling straightforward development of location-aware, global communicating applications. The application board provides access to Ethernet and CAN interfaces, and to a variety of hardware interfaces (22 GPIOs with SPI, I²C, UART, I²S) through a standard-based header connector.

The board is powered by a Cortex-M3 microprocessor, which is fully supported by the mbed platform. The CPU has 512 kB flash, 64 kB RAM, and runs at 96 MHz. The board provides simple USB drag-n-drop programming and a CMSIS-DAP debug interface for the target microcontroller. The mbed platform provides free software libraries and online tools for professional rapid prototyping. The programming is done using a standard-based C/C++ SDK. The mbed compiler also supports full export to different tool chains, for projects that demand it as they go to production.

C027-C20/U20/G35/ supports different cellular technologies via the u-blox nested design concept:

- CDMA 1xRTT: C027-C20 (LISA-C200-04S / LISA-C200-24S mounted)
- UMTS/HSPA/GSM/EGPRS: C027-U20 (LISA-U200-02S mounted)
- GSM/GPRS: C027-G35 (SARA-G350-01S mounted)



This document identifies all the variants as C027.

1.1 C027-C20/U20/G35 pin definition

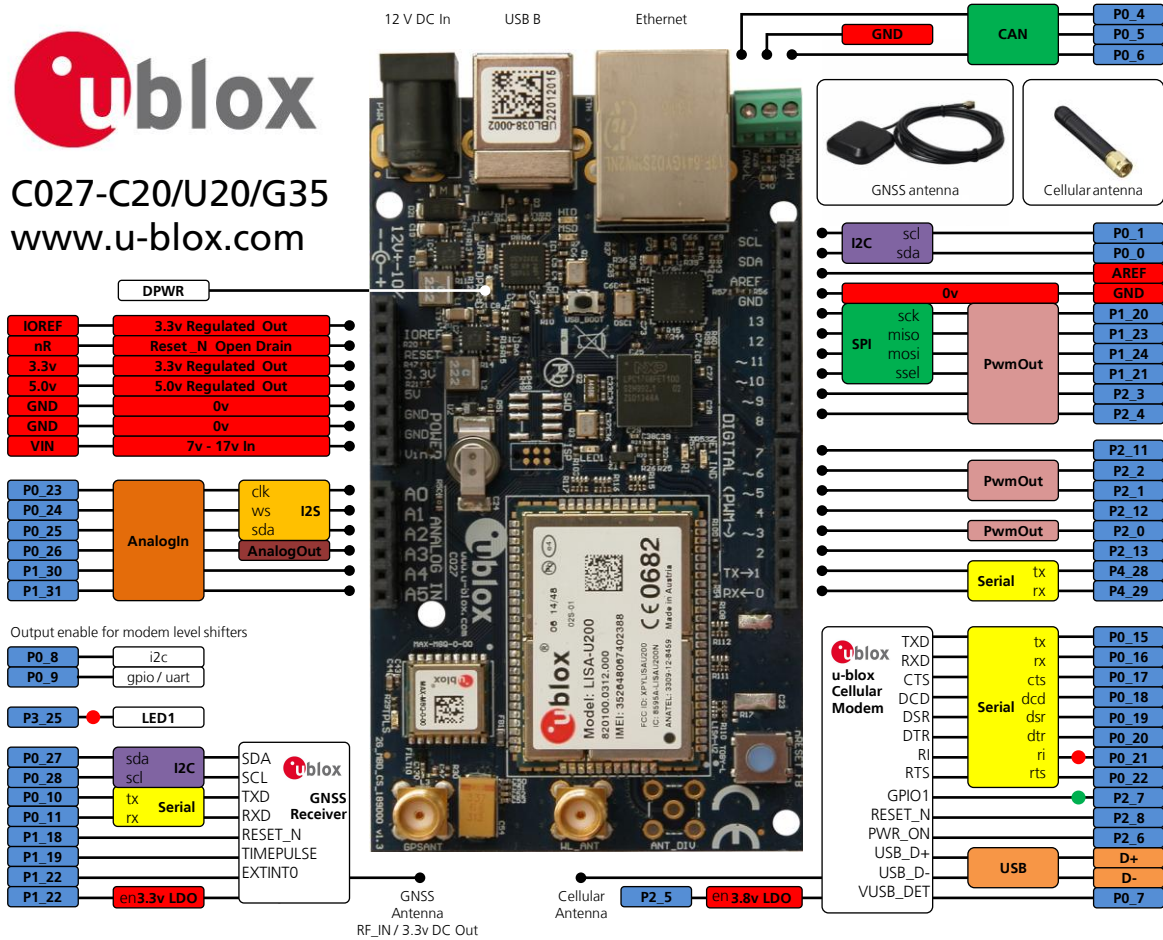

Figure 1: C027-C20/U20/G35 pin definition

1.2 C027-C20/U20/G35 block diagram

Figure 2 shows the main interfaces and internal connections of the C027:

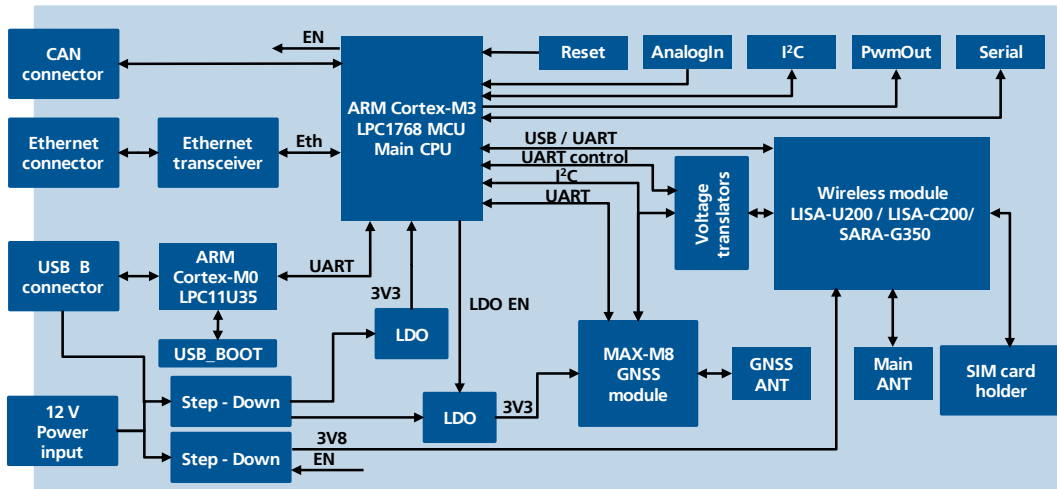

Figure 2: C027 block diagram

1.3 C027 starter kit BoM

The C027 IoT starter kit contains the following items:

- C027 PCB with cellular module, GNSS module, ARM CPU and all interfaces
- GNSS antenna (Taoglas AA.161 or AA.162)
- Quick start instruction card

1.4 Features

1.4.1 Cellular and GNSS modules

- LISA-C200 (C027-C20), LISA-U200 (C027-U20) or SARA-G350 (C027-G35)
- MAX-M8 GNSS receiver

1.4.2 Main CPU

- High-performance ARM(R) Cortex(TM)-M3 NXP LPC 1768 MCU running at 96 MHz
- 512 kByte on-chip flash
- 64 kByte on-chip SRAM

1.4.3 Interfaces and electrical data

- A standard-based header connector with
 - 6 analog inputs
 - 9 PWM capable outputs
 - 22 GPIOs
 - 1 x SPI
 - 1 x I²C
 - 1 x UART
 - 1 x I²S
- GNSS antenna SMA connector for external GNSS antenna

- Cellular antenna SMA connector for external cellular antenna
- Ethernet RJ45 connector
- CAN screw terminal connector
- SIM / mini SIM card holder
- USB (connector type B)
- CMSIS-DAP
- Serial port
- Power supply 12V ± 10% @ 900 mA (power jack or header connector pins)
- IO voltage 3.3 V output, 5 V compatible input

1.5 C027-C20/U20/G35 connectors

Function	Description
12V ± 10% Power Input	+12 V / 2.5 A AC/DC power adapter input for the whole board supply
CAN connector	Controller Area Network controlled by Cortex-M3 processor
USB B-type connector	Functions: disk drive for drag and drop programming, CDC Serial Port, CMSIS-DAP debug interface, power input
Ethernet connector	Ethernet connector for Cortex-M3 processor
Cellular main antenna	SMA connector for the cellular module main antenna
SIM card holder	SIM card holder
GNSS antenna	SMA connector for the GNSS antenna
Arduino connectors	I/O connectors compatible with Arduino devices

Table 1: C027-C20/U20/G35 connectors description

1.6 LEDs









Function	Description	Color
DPWR	USB cable plugged in USB B connector	
UART	CDC serial port activity	
MSD	Drag and drop programming activity	
HID	CMSIS-DAP debug interface activity	
NET_IND	Module network indicator	
RI	Module ring indicator	
TPLS	Indicates if the GNSS is synchronized with GNSS or UTC time grid	
LED1	User / error LED	

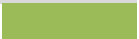

Table 2: C027-C20/U20/G35 LEDs description

2 Getting started with mbed

2.1 Board setup and settings

- Insert the SIM card into the SIM connector / card holder (not required for CDMA variants).
- Connect the cellular antenna to the cellular main antenna SMA female connector.
- Connect the GNSS antenna to GNSS antenna SMA female connector.

2.2 Board power supply

-  **There are three mutually exclusive ways to supply the board:**
- Connect a power supply to the **12 V DC In** connector (power supply is not included in the kit).
 - Provide power supply 12V to **VIN** pin of the row connector.
 - Connect C027 to host PC using USB cable (USB cable is not included in the kit).
-  **Due to the USB current limitation, optimal RF performance can be achieved only by supplying the board either through the 12 V DC In connector or the VIN pin of the row connector.**

2.3 Windows serial configuration

The mbed serial port works by default on Mac and Linux, but Windows OS needs a driver. The driver is available in: <https://mbed.org/handbook/Windows-serial-configuration>.

2.4 Board interface settings

- Connect a USB cable to the USB B connector. Status light DPWR (green LED) will come on.
- Connect the other interfaces (CAN, Ethernet) as needed.
- The board is ready.

2.5 Flashing the ARM-Cortex M0 LPC11U35 MCU

There is a "USB_BOOT" switch located near the small microcontroller unit.

- If you want to re-flash the ARM-Cortex M0 LPC11U35 MCU, then press the "USB_BOOT" switch and then connect the C027 device to the host PC via a USB cable.
- C027 device will appear as CRP DISABLD removable disk. To re-flash the FW, simply delete the file "firmware.bin" and copy the new firmware binary to this disk.
- Reconnect the USB cable. Your device will now appear as "MBED" removable disk and is ready for use.

2.6 Getting started with mbed

Up-to-date information on how to operate the C027 starter kit within the mbed development environment is available in: www.mbed.org/users/ublox/notebook/u-blox-C027-Getting-Started.

Other instructions and information:

- u-blox C027 downloading instructions: <https://mbed.org/users/ublox/notebook/u-blox-C027-Downloading/>
- Creating a program: <https://mbed.org/handbook/Creating-a-program>
- How to check the firmware version: <https://mbed.org/users/ublox/notebook/ublox-C027-Update-CMSIS-DAP-Interface-Firmware/>

3 Cloud services and analytics

u-blox C027 is pre-enabled to support the IBM Internet of Things Foundation through the [IBM Bluemix Platform](#), a hub that provides access to more than 100 open-source tools and platform services, for data storage and analytics.

The C027 internet of things starter kit provides users with an immediate access to IBM services, such as device registration, rapid visualization of dashboards and storage of data. Users can collect and manage a time-series view of data from things, run advanced analytics or even compose new analytics applications for multiple market verticals. Some examples are:

- Predictive modeling and geospatial analytics
- Understanding vehicle performance by analyzing data from its On-Board Diagnostic system
- Linking real-time machine condition monitoring with IBM asset management to monitor everything from the health of household appliances to wheels on a railroad car
- Spotting trends and obtaining solutions to common problems through graphical representation of historical and real-time data from IoT devices

Tutorials on how to get cellular connectivity to the [IBM Bluemix Platform](#) with C027 boards are available through the [IBM developerWorks Recipes](#) web site.

Related documents

All LISA-U, LISA-C and SARA-G technical documents are available on our homepage (<http://www.u-blox.com>).



For regular updates to u-blox documentation and to receive product change notifications, register on our homepage.

Revision history

Revision	Date	Name	Status / Comments
R01	13-Dec-2013	jpod	Initial Release
R02	28-Jan-2015	jbev	New ordering codes: C027-U20-0-02, C027-G35-0-02, C027-C20-0-02, C027-C20-1-02
R03	18-Nov-2015	smoi	New section, Cloud services and analytics

Contact

For complete contact information visit us at www.u-blox.com

u-blox Offices

North, Central and South America

u-blox America, Inc.

Phone: +1 703 483 3180
E-mail: info_us@u-blox.com

Regional Office West Coast:

Phone: +1 408 573 3640
E-mail: info_us@u-blox.com

Technical Support:

Phone: +1 703 483 3185
E-mail: support_us@u-blox.com

Headquarters

Europe, Middle East, Africa

u-blox AG

Phone: +41 44 722 74 44
E-mail: info@u-blox.com
Support: support@u-blox.com

Asia, Australia, Pacific

u-blox Singapore Pte. Ltd.

Phone: +65 6734 3811
E-mail: info_ap@u-blox.com
Support: support_ap@u-blox.com

Regional Office Australia:

Phone: +61 2 8448 2016
E-mail: info_anz@u-blox.com
Support: support_ap@u-blox.com

Regional Office China (Beijing):

Phone: +86 10 68 133 545
E-mail: info_cn@u-blox.com
Support: support_cn@u-blox.com

Regional Office China (Chongqing):

Phone: +86 23 6815 1588
E-mail: info_cn@u-blox.com
Support: support_cn@u-blox.com

Regional Office China (Shanghai):

Phone: +86 21 6090 4832
E-mail: info_cn@u-blox.com
Support: support_cn@u-blox.com

Regional Office China (Shenzhen):

Phone: +86 755 8627 1083
E-mail: info_cn@u-blox.com
Support: support_cn@u-blox.com

Regional Office India:

Phone: +91 959 1302 450
E-mail: info_in@u-blox.com
Support: support_in@u-blox.com

Regional Office Japan (Osaka):

Phone: +81 6 6941 3660
E-mail: info_jp@u-blox.com
Support: support_jp@u-blox.com

Regional Office Japan (Tokyo):

Phone: +81 3 5775 3850
E-mail: info_jp@u-blox.com
Support: support_jp@u-blox.com

Regional Office Korea:

Phone: +82 2 542 0861
E-mail: info_kr@u-blox.com
Support: support_kr@u-blox.com

Regional Office Taiwan:

Phone: +886 2 2657 1090
E-mail: info_tw@u-blox.com
Support: support_tw@u-blox.com