

SINGLE SUPPLY QUAD OPERATIONAL AMPLIFIER

■ GENERAL DESCRIPTION

The NJM12902 is a single-supply quad amplifier which can operate from 2V supply.

It features low voltage operation, small offset voltage, small bias current and directly drives TTL and DTL circuit.

2.5mm square leadless package PCSP-14 and standard surface mount package are available for a wide application coverage.

■ PACKAGE OUTLINE

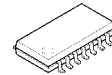

NJM12902M



NJM12902V



NJM12902SC3

■ FEATURES

- Operating Voltage (+2V~+14V)
- Input Offset Voltage (5mV max.)
- Slew Rate (0.7V/μs typ.)
- Operating Current (1.0mA typ.)
- Bipolar Technology
- Package Outline DMP14, SSOP14,PCSP14-C3

■ PIN CONFIGURATION

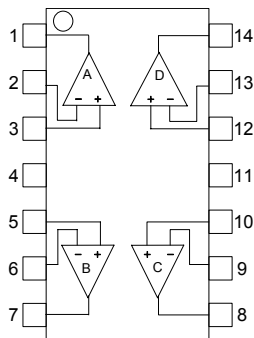

NJM12902M, NJM12902V

PIN FUNCTION

- | | |
|------------------|--------------------------|
| 1.A OUTPUT | 8.C OUTPUT |
| 2.A -INPUT | 9.C -INPUT |
| 3.A +INPUT | 10.C +INPUT |
| 4.V ⁺ | 11. GND(V ⁻) |
| 5.B +INPUT | 12.D +INPUT |
| 6.B -INPUT | 13.D -INPUT |
| 7.B OUTPUT | 14.D OUTPUT |

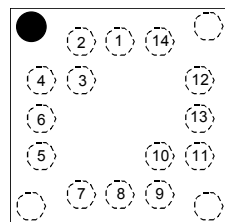

(TOP VIEW)

NJM12902SC3

PIN FUNCTION

- | | |
|------------------|--------------------------|
| 1.A OUTPUT | 8.C OUTPUT |
| 2.A -INPUT | 9.C -INPUT |
| 3.A +INPUT | 10.C +INPUT |
| 4.V ⁺ | 11. GND(V ⁻) |
| 5.B +INPUT | 12.D +INPUT |
| 6.B -INPUT | 13.D -INPUT |
| 7.B OUTPUT | 14.D OUTPUT |

NJM12902

■ EQUIVALENT CIRCUIT (1/4 Shown)

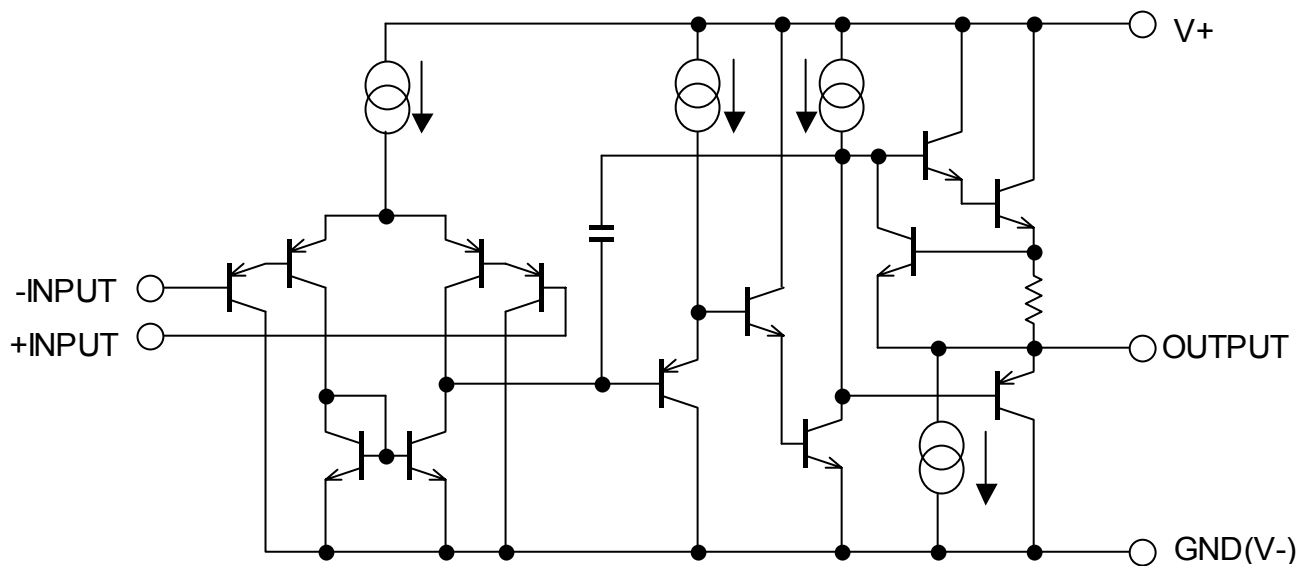

■ ABSOLUTE MAXIMUM RATINGS

(Ta=25°C)

PARAMETER	SYMBOL	RATINGS	UNIT
Supply Voltage	V*	15	V
Differential Input Voltage	V _{ID}	14	V
Input Voltage	V _{IC}	-0.3~+14	V
Power Dissipation	P _D	(DMP14) 300 (SSOP14) 300 (PCSP14-C3) 640 (Note1)	mW
Operating Temperature Range	T _{opr}	-40~+85	°C
Storage Temperature Range	T _{stg}	-50~+125	°C

(Note 1) On the PCB "EIA/JEDEC (114.3×76.2×1.6mm, 4 layers, FR-4)"

■ ELECTRICAL CHARACTERISTICS

(V*=5V, Ta=25°C)

PARAMETER	SYMBOL	TEST CONDITION	MIN.	TYP.	MAX.	UNIT
Operating Voltage	V _{opr}		2	-	14	V
Input Offset Voltage	V _{IO}	R _S =0Ω	-	1	5	mV
Input Offset Current	I _{IO}		-	5	50	nA
Input Bias Current	I _B		-	20	150	nA
Large Signal Voltage Gain	A _V	R _L ≥2kΩ	-	100	-	dB
Maximum Output Voltage Swing	V _{OPP}	R _L =2kΩ	3.5	-	-	V
Input Common Mode Voltage Range	V _{ICM}		0~3.5	-	-	V
Common Mode Rejection Ratio	CMR		-	85	-	dB
Supply Voltage Rejection Ratio	SVR		-	100	-	dB
Output Source Current	I _{SOURCE}	V _{IN+} =1V, V _{IN-} =0V	20	40	-	mA
Output Sink Current	I _{SINK}	V _{IN+} =0V, V _{IN-} =1V	8	30	-	mA
Channel Separation	CS	f=1k~20kHz	-	120	-	dB
Operating Current	I _{CC}	R _L =∞	-	1.0	2.0	mA
Slew Rate	SR	V*/V=±2.5V, R _L =2kΩ, A _V =0dB, f=1kHz	-	0.7	-	V/μs
Gain Bandwidth Product	GB		-	1.5	-	MHz

■ TYPICAL CHARACTERISTICS

Operating Current vs. Operating Voltage
($T_a=25^\circ\text{C}$)

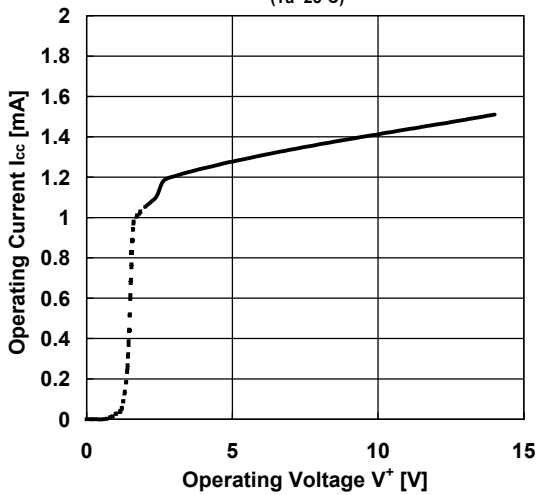

Input Offset Voltage vs. Operating Voltage
($T_a=25^\circ\text{C}$)

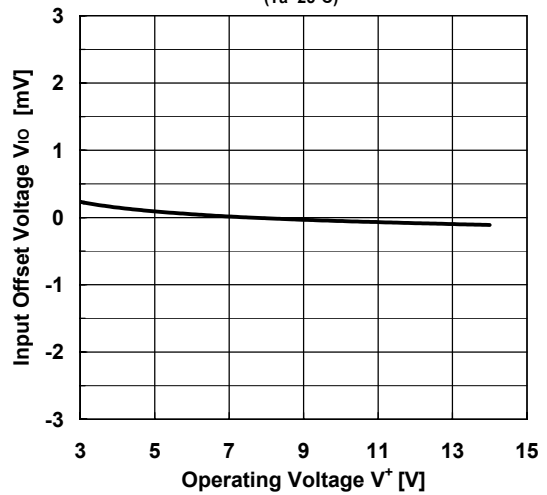

Input Bias Current vs. Operating Voltage
($T_a=25^\circ\text{C}$)

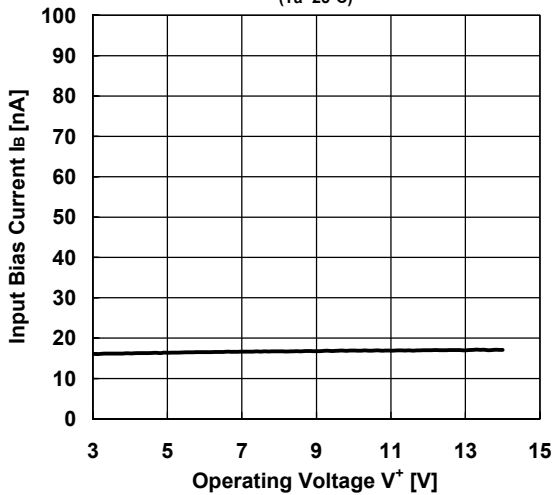

Maximum Output Voltage vs. Operating Voltage
($T_a=25^\circ\text{C}$)

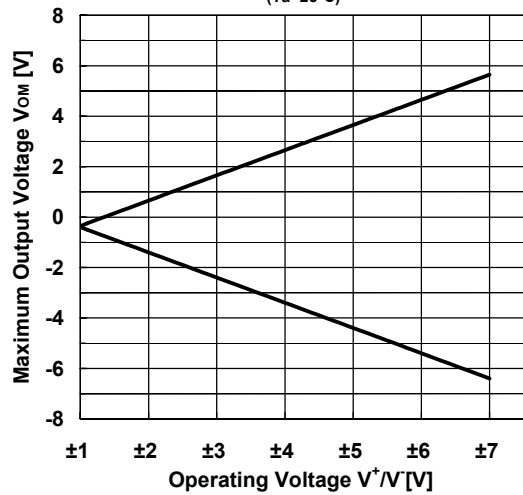

Input offset Voltage vs. Input voltage
($V^+=5\text{V}, T_a=25^\circ\text{C}$)

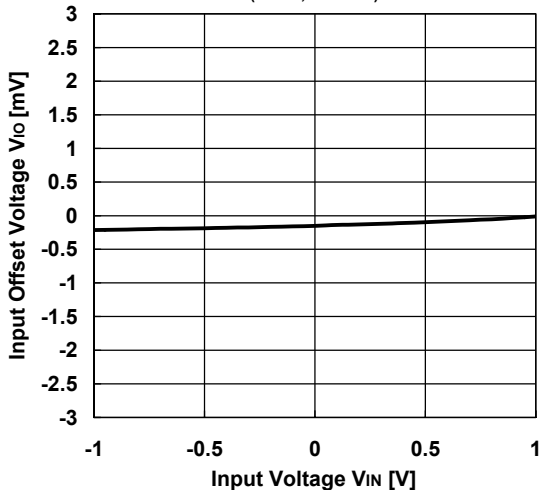

Maximum Output Voltage vs. Frequency
($V^+=5\text{V}, T_a=25^\circ\text{C}$)

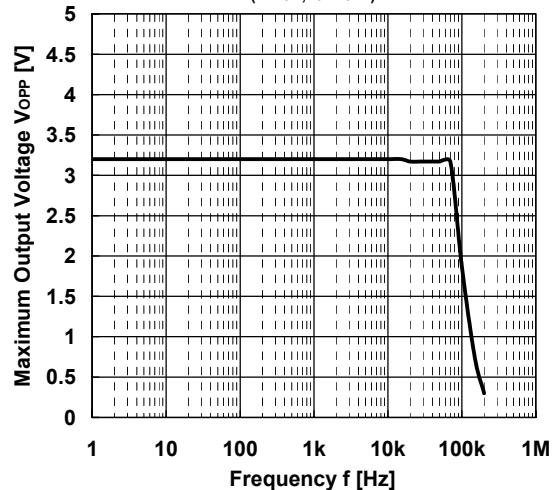

■ TYPICAL CHARACTERISTICS

Output Voltage vs. Output Sink Current
($V^+=5V, T_a=25^\circ C$)

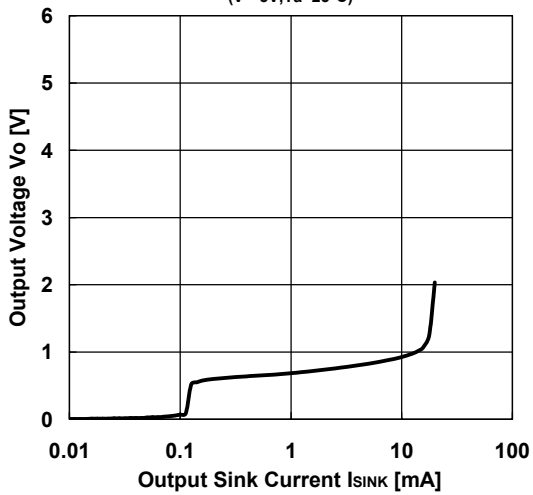

Output Voltage vs. Output Source Current
($V^+=5V, T_a=25^\circ C$)

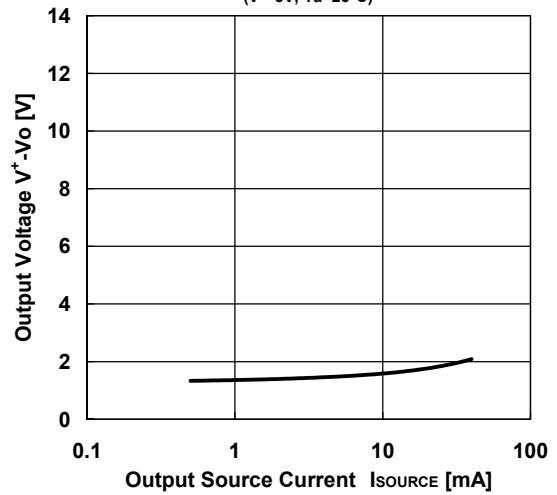

Voltage Gain vs. Operating Voltage
($R_L=2k\Omega, T_a=25^\circ C$)

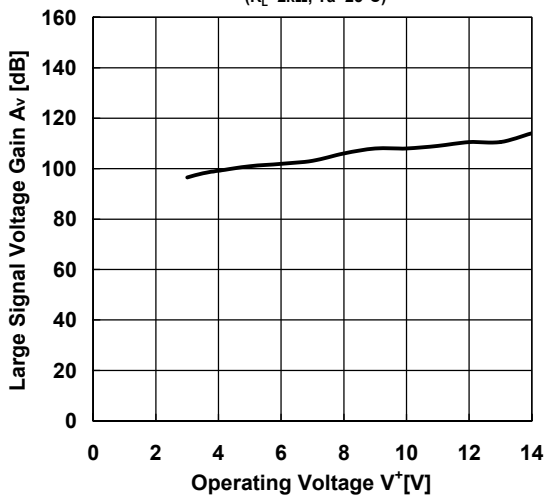

Voltage Gain / Phase vs. Frequency
($V^+=5V, T_a=25^\circ C$)

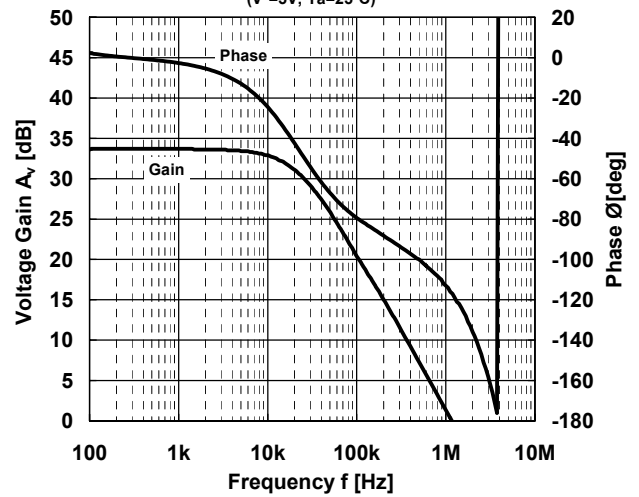

Slew Rate (Rise)
($V^+=5V, T_a=25^\circ C$)

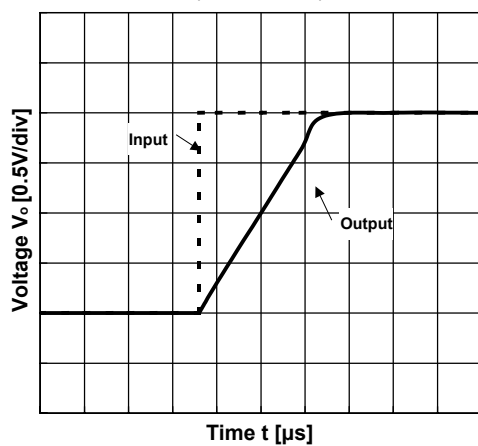

Slew Rate (Fall)
($V^+=5V, T_a=25^\circ C$)

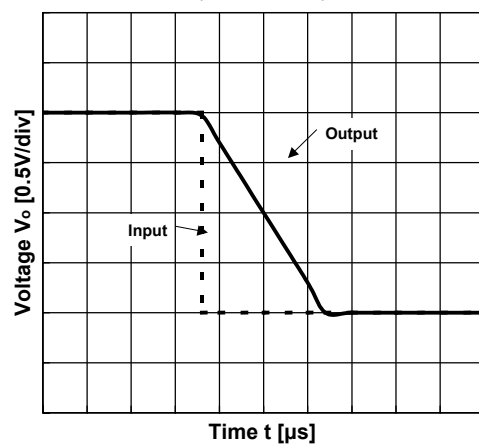

■ TYPICAL CHARACTERISTICS

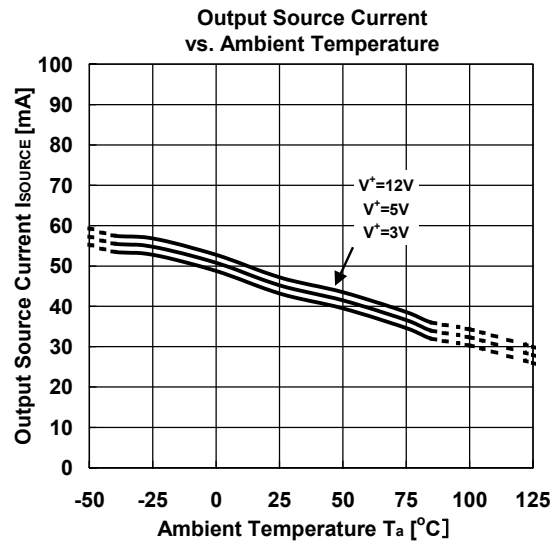
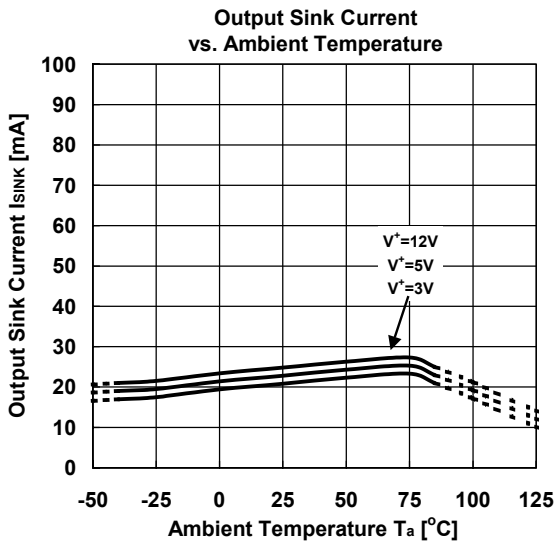
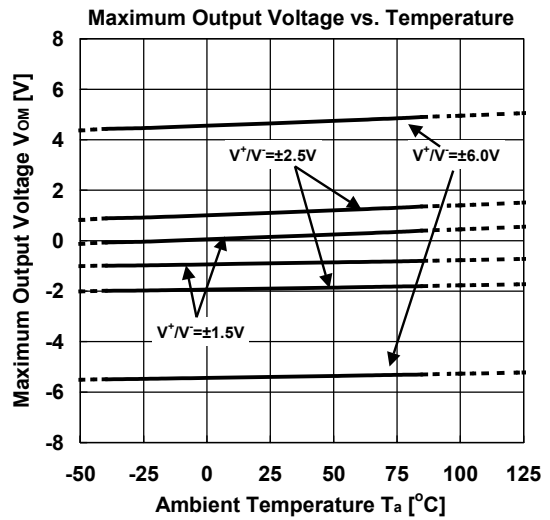
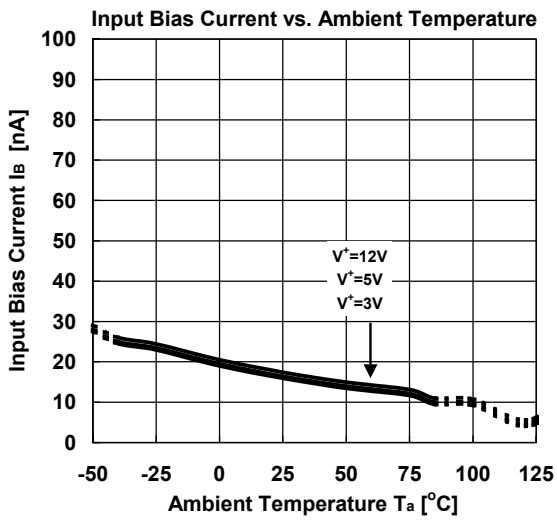
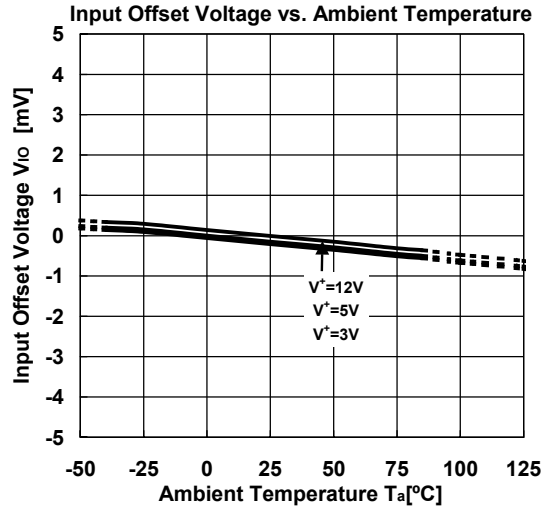
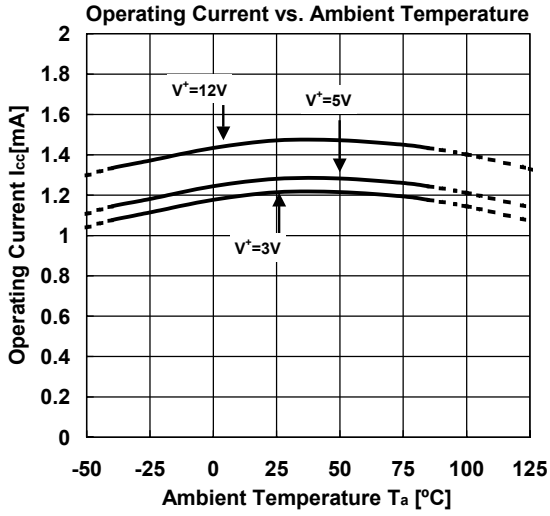

■ TYPICAL CHARACTERISTICS

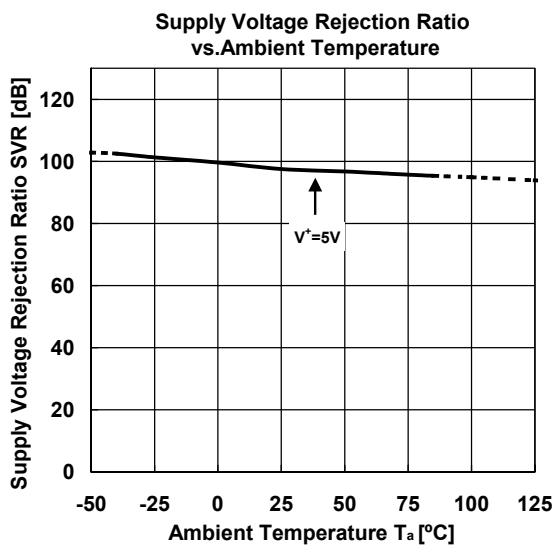
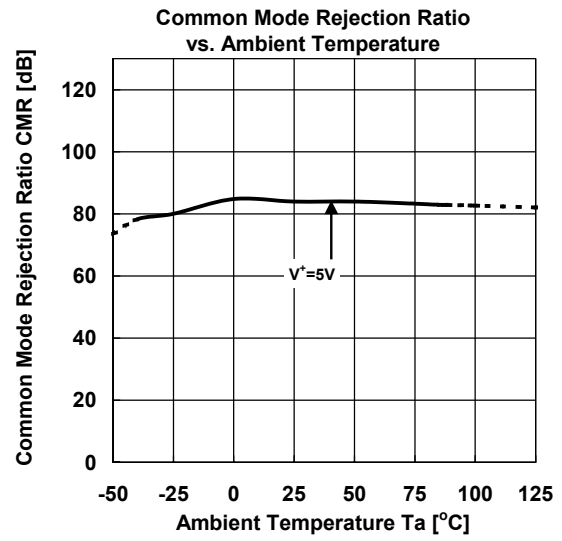
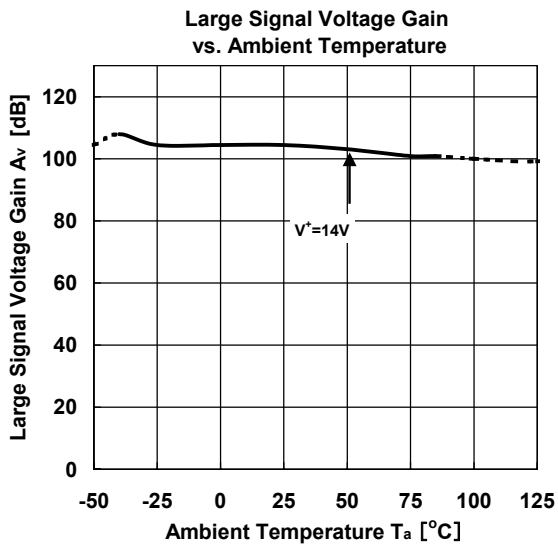

[CAUTION]

The specifications on this data book are only given for information, without any guarantee as regards either mistakes or omissions. The application circuits in this data book are described only to show representative usages of the product and not intended for the guarantee or permission of any right including the industrial rights.