



Website: www.displaytech.com.hk

LCD Module

Product Specification

Product: DT028ATFT & DT028ATFT-TS
2.8" TFT Display Module (240RGBx320DOTS)

Contents in this document are subject to change without notice. No part of this document may be reproduced or transmitted in any form or by any means, electronic or mechanical, for any purpose, without the express written permission of Displaytech Ltd.

3 November 2011.

1. REVISION RECORD

VERSION	CHANGES	DATE
1.0	Initial revision	26 April 2011
2.0	Added details of TS version in pages 3, 5, 7, & 8	9 June 2011
2.1	Changed the temperature range of TS version	3 November 2011

Table of Content

1. REVISION RECORD 1

2. Introduction 3

3. General Specifications 3

4. Mechanical Drawing..... 4

5. Interface Description 6

6. Absolute Maximum Ratings 8

7. Electrical Characteristics..... 8

8. Display Controller /Power Supply Timing 8

9. Backlight specification 9

10. Optical Characteristics..... 9

11. Safety Precaution 12

2. Introduction

DT028ATFT and **DT028ATFT-TS** is a display module that contains a TFT display with a 320 * 240 RGB resolution. The driver used for this project is the Ilitek **ILI9341** or **compatible** and can display 262K colors. The driver is mounted on the glass and the interconnection via FPC including components to drive the display module.

3. General Specifications

Item	Specification	Unit
LCD mode	Transmissive	---
Resolution	240(RGB)	Line
	320	Line
Diagonal Size	2.8	Inch
Overall Size	50.00	mm
	69.20	mm
Active area	43.20	mm
	57.60	mm
Optimum Viewing Direction	6 o'clock	---
Driver IC	ILI9341	---
Interface type	MCU parallel / RGB (1)	---
Colours	262K	---
Operation temperature range	-20~70	°C
Storage temperature range	-30~80	°C

Remarks:

- (1) Serial interface is available, but not recommendable, as the speed of it is very slow.
- (2) Recommended mating connector: Hirose FH19SC-45S-0.5SH, FH12S-45S-0.5SH; or Molex 0512964593, 0512964594; or equivalent
- (3) Color tune may be changed slightly by temperature and driving voltage.
- (4) RoHS compliant.

Component Life Cycle

- 1) Storage Life: min. 1 Year
- 2) Operation Life (*1): min. 43 x 10³ h (24hr/day x 7days/week x 52weeks/year x 5years)
(Not include backlight)
- 3) Storage and Operation Life Times are defined for a temperature of +25°C

Notes:

*1. Operation life ends when one of the listed faults occurs:

- The on/off response-times reach 1.5 times of the max. value specified for a new display
- The contrast is reduced to 0.5 of the original contrast value
- Loss of function
- The number of cosmetic defects exceeds the maximum defined

4. Mechanical Drawing

• DT028ATFT

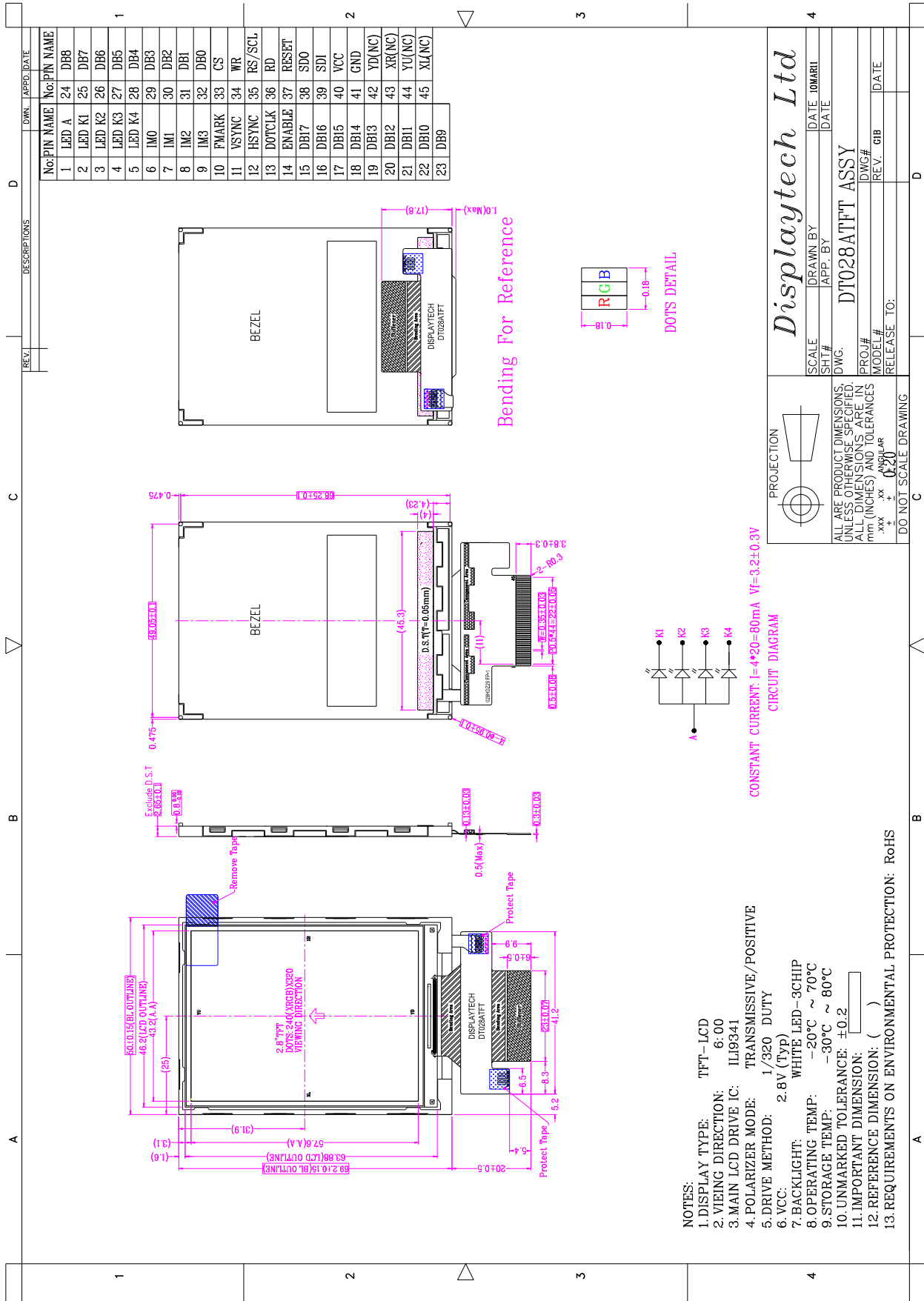

- NOTES:**
1. DISPLAY TYPE: TFT-LCD
 2. VIEWING DIRECTION: 6:00
 3. MAIN LCD DRIVE IC: ILI9341
 4. POLARIZER MODE: TRANSMISSIVE/ POSITIVE
 5. DRIVE METHOD: 1/320 DUTY
 6. VCC: 2.8V (Typ)
 7. BACKLIGHT: WHITE LED-3CHIP
 8. OPERATING TEMP: -20°C ~ 70°C
 9. STORAGE TEMP: -30°C ~ 80°C
 10. UNMARKED TOLERANCE: ±0.2
 11. IMPORTANT DIMENSION: ()
 12. REFERENCE DIMENSION: ()
 13. REQUIREMENTS ON ENVIRONMENTAL PROTECTION: RoHS

• DT028ATFT-TS

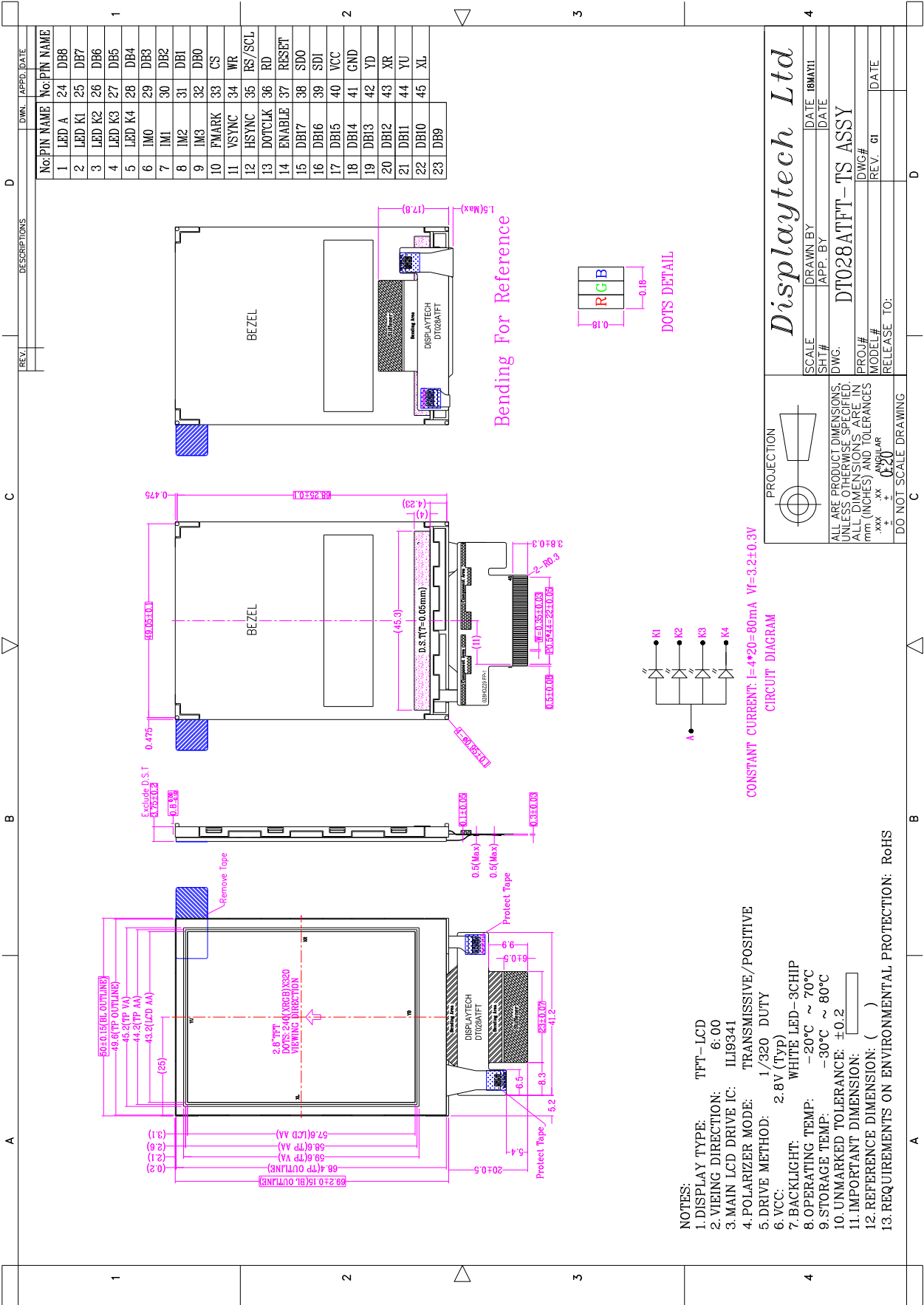

5. Interface Description

Pin no	Symbol	I/O	Description																																																																																													
1	LED A	---	Backlight anode.																																																																																													
2	LED K1	---	Backlight cathode K1																																																																																													
3	LED K2	---	Backlight cathode K2																																																																																													
4	LED K3	---	Backlight cathode K3																																																																																													
5	LED K4	---	Backlight cathode K4																																																																																													
6	IM0	I	- Select the MCU interface mode																																																																																													
			<table border="1"> <thead> <tr> <th rowspan="2">IM3</th> <th rowspan="2">IM2</th> <th rowspan="2">IM1</th> <th rowspan="2">IM0</th> <th rowspan="2">MCU-Interface Mode</th> <th colspan="2">DB Pin in use</th> </tr> <tr> <th>Register/Content</th> <th>GRAM</th> </tr> </thead> <tbody> <tr> <td>0</td> <td>0</td> <td>0</td> <td>0</td> <td>80 MCU 8-bit bus interface I</td> <td>D[7:0]</td> <td>D[7:0]</td> </tr> <tr> <td>0</td> <td>0</td> <td>0</td> <td>1</td> <td>80 MCU 16-bit bus interface I</td> <td>D[7:0]</td> <td>D[15:0]</td> </tr> <tr> <td>0</td> <td>0</td> <td>1</td> <td>0</td> <td>80 MCU 9-bit bus interface I</td> <td>D[7:0]</td> <td>D[8:0]</td> </tr> <tr> <td>0</td> <td>0</td> <td>1</td> <td>1</td> <td>80 MCU 18-bit bus interface I</td> <td>D[7:0]</td> <td>D[17:0]</td> </tr> <tr> <td>0</td> <td>1</td> <td>0</td> <td>1</td> <td>3-wire 9-bit data serial interface I</td> <td colspan="2">SDA: In/OUT</td> </tr> <tr> <td>0</td> <td>1</td> <td>1</td> <td>0</td> <td>4-wire 8-bit data serial interface I</td> <td colspan="2">SDA: In/OUT</td> </tr> <tr> <td>1</td> <td>0</td> <td>0</td> <td>0</td> <td>80 MCU 16-bit bus interface II</td> <td>D[8:1]</td> <td>D[17:10], D[8:1]</td> </tr> <tr> <td>1</td> <td>0</td> <td>0</td> <td>1</td> <td>80 MCU 8-bit bus interface II</td> <td>D[17:10]</td> <td>D[17:10]</td> </tr> <tr> <td>1</td> <td>0</td> <td>1</td> <td>0</td> <td>80 MCU 18-bit bus interface II</td> <td>D[8:1]</td> <td>D[17:0]</td> </tr> <tr> <td>1</td> <td>0</td> <td>1</td> <td>1</td> <td>80 MCU 9-bit bus interface II</td> <td>D[17:10]</td> <td>D[17:9]</td> </tr> <tr> <td>1</td> <td>1</td> <td>0</td> <td>1</td> <td>3-wire 9-bit data serial interface II</td> <td colspan="2">SDI: In SDO: Out</td> </tr> <tr> <td>1</td> <td>1</td> <td>1</td> <td>0</td> <td>4-wire 8-bit data serial interface II</td> <td colspan="2">SDI: In SDO: Out</td> </tr> </tbody> </table>	IM3	IM2	IM1	IM0	MCU-Interface Mode	DB Pin in use		Register/Content	GRAM	0	0	0	0	80 MCU 8-bit bus interface I	D[7:0]	D[7:0]	0	0	0	1	80 MCU 16-bit bus interface I	D[7:0]	D[15:0]	0	0	1	0	80 MCU 9-bit bus interface I	D[7:0]	D[8:0]	0	0	1	1	80 MCU 18-bit bus interface I	D[7:0]	D[17:0]	0	1	0	1	3-wire 9-bit data serial interface I	SDA: In/OUT		0	1	1	0	4-wire 8-bit data serial interface I	SDA: In/OUT		1	0	0	0	80 MCU 16-bit bus interface II	D[8:1]	D[17:10], D[8:1]	1	0	0	1	80 MCU 8-bit bus interface II	D[17:10]	D[17:10]	1	0	1	0	80 MCU 18-bit bus interface II	D[8:1]	D[17:0]	1	0	1	1	80 MCU 9-bit bus interface II	D[17:10]	D[17:9]	1	1	0	1	3-wire 9-bit data serial interface II	SDI: In SDO: Out		1	1	1	0	4-wire 8-bit data serial interface II	SDI: In SDO: Out	
			IM3						IM2	IM1	IM0	MCU-Interface Mode	DB Pin in use																																																																																			
				Register/Content	GRAM																																																																																											
			0	0	0	0	80 MCU 8-bit bus interface I	D[7:0]	D[7:0]																																																																																							
			0	0	0	1	80 MCU 16-bit bus interface I	D[7:0]	D[15:0]																																																																																							
			0	0	1	0	80 MCU 9-bit bus interface I	D[7:0]	D[8:0]																																																																																							
			0	0	1	1	80 MCU 18-bit bus interface I	D[7:0]	D[17:0]																																																																																							
			0	1	0	1	3-wire 9-bit data serial interface I	SDA: In/OUT																																																																																								
			0	1	1	0	4-wire 8-bit data serial interface I	SDA: In/OUT																																																																																								
			1	0	0	0	80 MCU 16-bit bus interface II	D[8:1]	D[17:10], D[8:1]																																																																																							
			1	0	0	1	80 MCU 8-bit bus interface II	D[17:10]	D[17:10]																																																																																							
			1	0	1	0	80 MCU 18-bit bus interface II	D[8:1]	D[17:0]																																																																																							
			1	0	1	1	80 MCU 9-bit bus interface II	D[17:10]	D[17:9]																																																																																							
			1	1	0	1	3-wire 9-bit data serial interface II	SDI: In SDO: Out																																																																																								
			1	1	1	0	4-wire 8-bit data serial interface II	SDI: In SDO: Out																																																																																								
			MPU Parallel interface bus and serial interface select																																																																																													
			If use RGB Interface must select serial interface.																																																																																													
			* : Fix this pin at VDDI or VSS.																																																																																													
10	FMARK	O	Tearing effect output pin to synchronize MPU to frame writing, activated by S/W command. When this pin is not activated, this pin is low. If not used, open this pin.																																																																																													
11	VSYNC	I	Frame synchronizing signal for RGB interface operation. <i>Fix to VDDI or VSS level when not in use.</i>																																																																																													
12	HSYNC	I	Line synchronizing signal for RGB interface operation. <i>Fix to VDDI or VSS level when not in use.</i>																																																																																													
13	DOTCLK	I	Dot clock signal for RGB interface operation. <i>Fix to VDDI or VSS level when not in use.</i>																																																																																													
14	ENABLE	I	Data enable signal for RGB interface operation. <i>Fix to VDDI or VSS level when not in use.</i>																																																																																													
15~32	DB17~DB0	I/O	18-bit parallel bi-directional data bus for MCU system and RGB interface mode <i>Fix to VSS level when not in use.</i> Please refer to the IM[0:3] setting.																																																																																													
33	CS	I	Chip select input pin ("Low" enable). This pin can be permanently fixed "Low" in MPU interface mode only.																																																																																													
34	WR	I	- 8080-I / 8080-II system (WRX): Serves as a write signal and writes data at the rising edge. - 4-line system (D/CX): Serves as command or parameter select. <i>Fix to VDDI or VSS level when not in use.</i>																																																																																													

Pin no	Symbol	I/O	Description
35	RS/SCL	I	This pin is used to select "Data or Command" in the parallel interface or 4-wire 8-bit serial data interface. When RS = '1', data is selected. When RS = '0', command is selected. This pin is used serial interface clock in 3-wire 9-bit / 4-wire 8-bit serial data interface. If not used, this pin should be connected to VDDI or VSS.
36	RD	I	8080-I / 8080-II system (RDX): Serves as a read signal and MCU read data at the rising edge. <i>Fix to VDDI or VSS level when not in use.</i>
37	RESET	I	Reset pin.
38	SDO	O	Serial output signal. The data is outputted on the falling edge of the SCL signal. If not used, open this pin
39	SDI	I	When IM[3] : Low, Serial in/out signal. When IM[3] : High, Serial input signal. The data is applied on the rising edge of the SCL signal. If not used, fix this pin at VDDI or VSS.
40	VCC	---	Power supply 2.8V
41	GND	---	Power ground 0V
42	NC / YD	---	No connection (DT028ATFT) / YD of touch screen (DT028ATFT-TS)
43	NC / XR	---	No connection (DT028ATFT) / XR of touch screen (DT028ATFT-TS)
44	NC / YU	---	No connection (DT028ATFT) / YU of touch screen (DT028ATFT-TS)
45	NC / XL	---	No connection (DT028ATFT) / XL of touch screen (DT028ATFT-TS)

6. Absolute Maximum Ratings

(Ta=25°C)

Item	Symbol	Min.	Max.	Unit
Power supply voltage	VCC	-0.3	+ 4.6	V
Logic signal input/output voltage	Vcc	-0.3	+ 4.6	V
Operating Temperature	TOP	-20	+70	°C
Storage Temperature	TST	-30	+80	°C

Note:

- When temperature is below 0°C, the response time of liquid crystal (LC) will be slower and the color of panel will be darker.
- If module driving condition exceeds the absolute maximum ratings, permanent damaged may be resulted. If module is driven within the absolute maximum ratings but exceeded the DC characteristics, mal-function may be resulted.
- VDD/VCC > VSS

7. Electrical Characteristics

DC Characteristics

(Vss=0V, Ta=25°C)

Item	Symbol	Condition	Min.	Typ.	Max.	Unit
Power supply	VCC / VDD		2.5	2.8	3.3	V
Input voltage "H"	VIH	---	0.7 VCC	---	VCC	V
Input voltage "L"	VIL	---	VSS	---	0.3 VCC	V
Output voltage "H"	VOH	IOL=-1.0mA	0.8 VCC	---	VCC	V
Output voltage "L"	VOL	IOL=1.0mA	VSS	---	0.2 VCC	V

8. Display Controller /Power Supply Timing

See Display Controller Specification: Ilitek ILI9341

9. Backlight specification

(Vcc=2.8V, Vss=0V, Ta=25°C)

Item	Symbol	Condition	Min	Typ	Max	Unit	Note
Supply voltage	Vf	If=80mA	2.9	3.2	3.5	V	1
Forward current	If		---	---	80	mA	2
Uniformity	ΔBp	If=80mA	80	---	---	%	
Color coordination	X		0.270	---	0.315	---	
	Y		0.270	---	0.315	---	

LED circuit diagram:

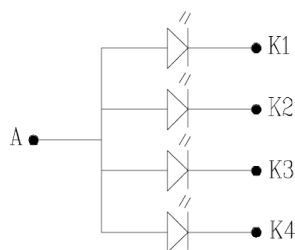

CIRCUIT DIAGRAM

Constant current If=4x20mA=80mA; Vf=3.2V(typ)

Note:

- 1) The LED's driver mode needs to be constant current mode.
- 2) Permanent damage to the device may occur if maximum values are exceeded. Functional operation should be restricted to the conditions described under normal operating conditions.

10. Optical Characteristics

(Vcc=2.8V, Vss=0V, Ta=25°C)

Item	Symbol	Condition	Min	Typ	Max	Unit	Note
Brightness	Bp	θ=0°	180	220	---	cd/m ²	1
Uniformity	ΔBp	Φ=0°	80	---	---	%	1, 2
Viewing Angle	θ1 (Φ=90° or 270°)	Cr≥10	-70 ~ 50			deg	3
	θ2 (Φ=0° or 180°)		-70 ~ 70				
Contrast ratio	Cr	θ=0° Φ=0°	400	500	---	---	4
Response Time	Tr		---	25	30	ms	5
	Tf						
CIE (x,y) Chromaticity	White	x	0.230	0.280	0.330	---	1, 6
		y	0.248	0.298	0.348		
	Red	x	0.580	0.630	0.680		
		y	0.279	0.329	0.379		
	Green	x	0.288	0.338	0.388		
		y	0.557	0.607	0.657		
	Blue	x	0.093	0.143	0.193		
		y	0.025	0.075	0.125		
NTSC Ratio	S	---	65	---	%		

Note 1: The data are measured after LEDs are turned on for 5 minutes. LCM displays full white.
The brightness is the average value of 9 measured spots. Measurement equipment PR-705 (Φ8mm)

Measuring condition:

- Measuring surroundings: Dark room.
- Measuring temperature: Ta=25°C.
- Adjust operating voltage to get optimum contrast at the center of the display.

Measured value at the center point of LCD panel after more than 5 minutes while backlight turning on.

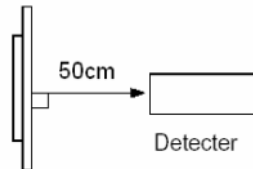

Note 2: The luminance uniformity is calculated by using following formula.

$$\Delta Bp = Bp (\text{Min.}) / Bp (\text{Max.}) \times 100 (\%)$$

Bp (Max.) = Maximum brightness in 9 measured spots

Bp (Min.) = Minimum brightness in 9 measured spots.

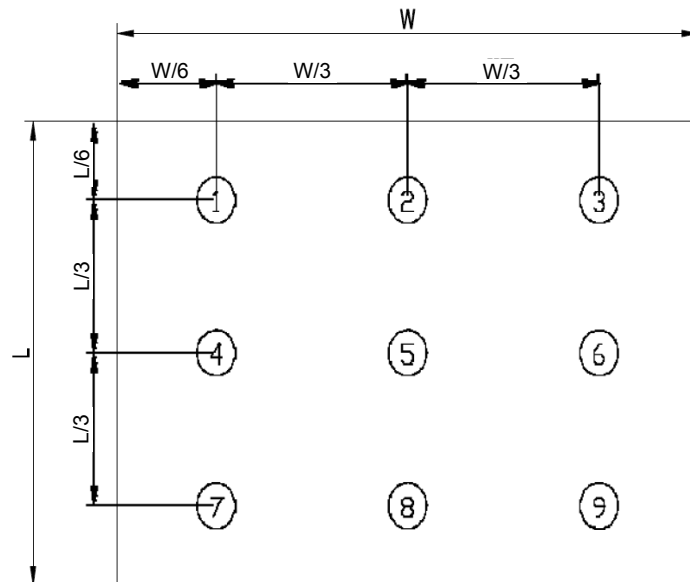

Measurement equipment PR-705 (Φ8mm)

Note 3: The definition of viewing angle:
Refer to the graph below marked by θ and Φ

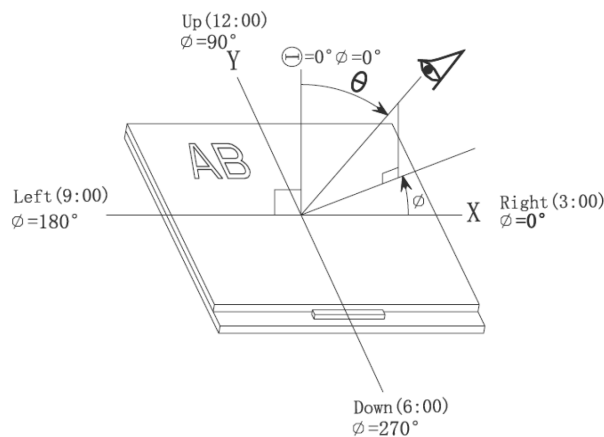

Note 4: The definition of contrast ratio (Test LCM using PR-705):

$$\text{Contrast Ratio (CR)} = \frac{\text{Luminance When LCD is at "White" state}}{\text{Luminance When LCD is at "Black" state}}$$

(Contrast Ratio is measured in optimum common electrode voltage)

Note 5: Definition of Response time. (Test LCD using DMS501):

The output signals of photo detector are measured when the input signals are changed from "black" to "white" (falling time) and from "white" to "black" (rising time), respectively.

The response time is defined as the time interval between the 10% and 90% of amplitudes. Refer to figure as below.



The definition of response time

Note 6: Definition of Color of CIE Coordinate and NTSC Ratio.

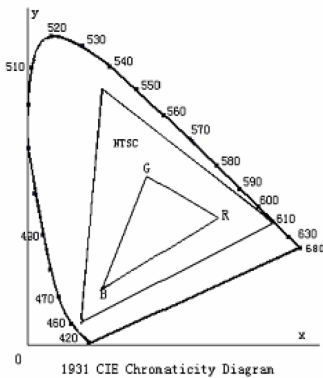

Color gamut:

$$S = \frac{\text{area of RGB triangle}}{\text{area of NTSC triangle}} \times 100\%$$

11. Safety Precaution

Handling precautions:

- This device is susceptible to Electro-Static Discharge (ESD) damage. Observe Anti-Static precautions.

Power supply precautions:

- Identify and, at all times, observe absolute maximum ratings for both logic and LC drivers. Note that there is some variance between models.
- Prevent the application of reverse polarity to VCC and GND, however briefly.
- Use a clean power source free from transients. Power up conditions are occasionally “jolting” and may exceed the maximum ratings of the modules.
- The VCC power of the module should also supply the power to all devices that may access the display. Don’t allow the data bus to be driven when the logic supply to the module is turned off.

Operating precautions:

- DO NOT plug or unplug the module when the system is powered up.
- Minimize the cable length between the module and host MPU.
- Operate the module within the limits of the modules temperature specifications.

Mechanical/Environmental precautions:

- Improper soldering is the major cause of module difficulty. Use of flux cleaner is not recommended as they may seep under the elastomeric connection and cause display failure.
- Mount the module so that it is free from torque and mechanical stress.
- Surface of the LCD panel should not be touched or scratched. The display front surface is an easily scratched, plastic polarizer. Avoid contact and clean only when necessary with soft, absorbent cotton dampened with petroleum benzene.
- Always employ anti-static procedure while handling the module.
- Prevent moisture build-up upon the module and observe the environmental constraints for storage temperature and humidity.
- Do not store in direct sunlight
- If leakage of the liquid crystal material should occur, avoid contact with this material, particularly ingestion. If the body or clothing becomes contaminated by the liquid crystal material, wash thoroughly with water and soap