

DESCRIPTION

The MP2635 is a highly-integrated, flexible, switch-mode battery charge management and system power path management device for a single-cell Li-ion and Li-Polymer battery used in a wide range of portable applications.

The MP2635 has two operating modes—charge mode and boost mode—to allow management of system and battery power based on the state of the input.

When input power is present, the device operates in charge mode. It automatically detects the battery voltage and charges the battery in the three phases: trickle current, constant current and constant voltage. Other features include charge termination and auto-recharge. This device also integrates both input current limit and input voltage regulation in order to manage input power and meet the priority of the system power demand.

In the absence of an input source, the MP2635 switches to boost mode through the MODE pin to power the SYS pins from the battery. The OLIM pin programs the output current limit in boost mode. The MP2635 also allows an output short-circuit thanks to an output disconnect feature, and can auto-recover when the short circuit fault is removed.

The MP2635 provides full operating status indication to distinguish charge mode from boost mode.

The MP2635 achieves low EMI/EMC performance with well-controlled switching edges.

To guarantee safe operation, the MP2635 limits the die temperature to a preset value 120°C. Other safety features include input over-voltage protection, battery over-voltage protection, thermal shutdown, battery temperature monitoring, and a programmable timer to prevent prolonged charging of a dead battery.

The MP2635 has two battery full options. MP2635: 4.2V/3.6V; MP2635B: 4.35V/4.2V.

FEATURES

- 4.5V-to-6V Operating Input Voltage Range
- Power Management Function Integrated Input-Current Limit and Input-Voltage Regulation
- Up to 2A Programmable Charge Current
- Trickle-Charge Function
- Selectable Charge Voltage with 0.5% Accuracy: 3.6V/4.2V(MP2635) or 4.35V/4.2V(MP2635B)
- Negative Temperature Coefficient Pin for Battery Temperature Monitoring
- Programmable Timer Back-Up Protection
- Thermal Regulation and Thermal Shutdown
- Internal Battery Reverse Leakage Blocking
- Reverse Boost Operation Mode for System Power
- Up to 91% 5V Boost Mode Efficiency @ 1A
- Programmable Output Current Limit for Boost Mode
- Integrated Short Circuit Protection for Boost Mode

APPLICATIONS

- Sub-Battery Applications
- Power-Bank Applications for Smart-Phone Tablet and Other Portable Devices

All MPS parts are lead-free and adhere to the RoHS directive. For MPS green status, please visit MPS website under Products, Quality Assurance page.

"MPS" and "The Future of Analog IC Technology" are registered trademarks of Monolithic Power Systems, Inc.

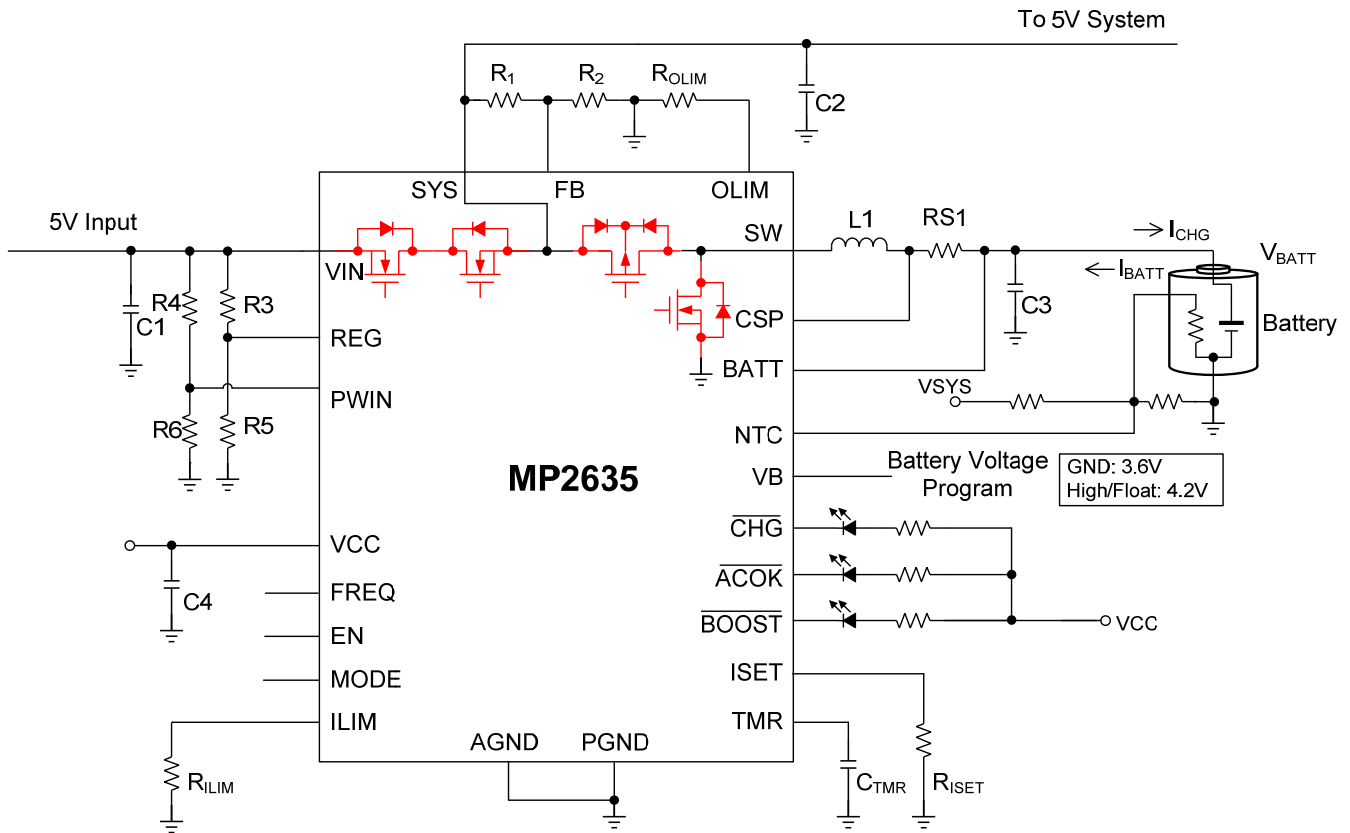
TYPICAL APPLICATION

Table 1: Operation Mode

| Power Source | ACOK | EN | MODE | Operating Mode |
|--|------|------|------|-------------------------------|
| $0.8V < P_{WIN} < 1.15V$ & $V_{IN} > V_{BATT} + 300mV$ | Low | High | X | Charge Mode, Enable Charging |
| | | Low | | Charge Mode, Disable Charging |
| $P_{WIN} < 0.8V$ or $P_{WIN} > 1.15V$ or $V_{IN} < V_{BATT} + 300mV$ | High | X | High | Boost Mode |
| $V_{IN} < 2V$ | High | X | Low | Sleep Mode |

X=Don't Care.

ORDERING INFORMATION

| Part Number* | Battery Full Voltage | Package | Top Marking |
|--------------|---|------------------|-------------|
| MP2635GR | 4.2V (VB=logic high/float) or 3.6V (VB=GND) | QFN-24 (4mm×4mm) | M2635E |
| MP2635BGR | 4.2V (VB=logic high/float) or 4.35V (VB=GND) | QFN-24 (4mm×4mm) | M2635B |

* For Tape & Reel, add suffix -Z (e.g. MP2635GR-Z, MP2635BGR-Z);

PACKAGE REFERENCE

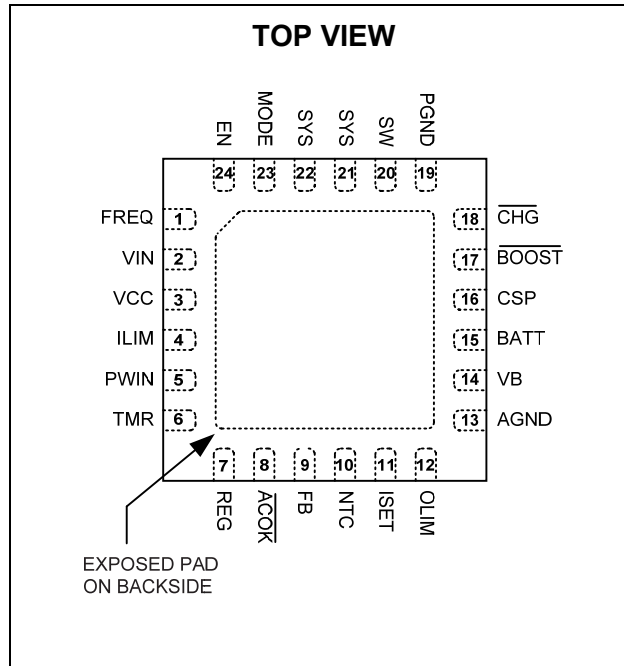

ABSOLUTE MAXIMUM RATINGS ⁽¹⁾

| | |
|--|--|
| VIN | -0.3V to 20V |
| SYS | -0.3V to 6.5V |
| SW | -0.3V (-2V for <20ns) to 6.5V (8.5V for <20ns) |
| BATT | -0.3V to 6.5V |
| ACOK, CHG, BOOST | -0.3V to 6.5V |
| All Other Pins | -0.3V to 6.5V |
| Junction Temperature | 150°C |
| Lead Temperature | 260°C |
| Continuous Power Dissipation (T _A = +25°C) ⁽²⁾ | 2.97W |
| Junction Temperature | 150°C |
| Operating Temperature | -20°C to +85°C |

Recommended Operating Conditions ⁽³⁾

| | |
|--|-----------------|
| Supply Voltage VIN | 4.5V to 6V |
| Battery Voltage V _{OUT} | 2.5V to 4.35V |
| Operating Junction Temp. (T _J) | -40°C to +125°C |

| Thermal Resistance ⁽⁴⁾ | θ_{JA} | θ_{JC} |
|-----------------------------------|---------------|---------------|
| QFN-24 (4mm×4mm) | 42 | 9 ... °C/W |

Notes:

- Exceeding these ratings may damage the device.
- The maximum allowable power dissipation is a function of the maximum junction temperature T_J (MAX), the junction-to-ambient thermal resistance θ_{JA} , and the ambient temperature T_A. The maximum allowable continuous power dissipation at any ambient temperature is calculated by P_D (MAX) = (T_J (MAX)-T_A)/ θ_{JA} . Exceeding the maximum allowable power dissipation will cause excessive die temperature, and the regulator will go into thermal shutdown. Internal thermal shutdown circuitry protects the device from permanent damage.
- The device is not guaranteed to function outside of its operating conditions.
- Measured on JESD51-7, 4-layer PCB.

ELECTRICAL CHARACTERISTICS

$V_{IN} = 5.0V$, $T_A = 25^{\circ}C$, unless otherwise noted.

| Parameter | Symbol | Condition | Min | Typ | Max | Units | |
|---|-------------------|----------------------------|----------------------------|-------|-------|------------|---|
| IN to SYS NMOS ON Resistance | $R_{IN\ to\ SYS}$ | | | 100 | | m Ω | |
| High-side PMOS ON Resistance | $R_{H\ DS}$ | | | 72 | | m Ω | |
| Low-side NMOS ON Resistance | $R_{L\ DS}$ | | | 70 | | m Ω | |
| High-Side PMOS Peak Current Limit | I_{PEAK_HS} | CC Charge Mode/ Boost Mode | | 4 | | A | |
| | | TC Charge Mode | | 1.5 | | A | |
| Low-Side NMOS Peak Current Limit | I_{PEAK_LS} | | | 4.5 | | A | |
| Switching Frequency | f_{sw} | FREQ = 0 | | 600 | | kHz | |
| | | FREQ = Float/ High | | 1200 | | | |
| VCC UVLO | $V_{CC\ UVLO}$ | | 2 | 2.2 | 2.4 | V | |
| VCC UVLO Hysteresis | | | | 100 | | mV | |
| PWIN Lower Threshold | $V_{PWIN\ L}$ | | 0.75 | 0.8 | 0.85 | V | |
| Lower Threshold Hysteresis | | | | 40 | | mV | |
| PWIN Upper Threshold | $V_{PWIN\ H}$ | | 1.1 | 1.15 | 1.2 | V | |
| Upper Threshold Hysteresis | | | | 65 | | mV | |
| Charge Mode | | | | | | | |
| Input Quiescent Current | I_{IN} | EN = 5V, Battery Float | | | 2.5 | mA | |
| | | EN = 0 | | | 1.5 | mA | |
| Input Current Limit | I_{IN_LIMIT} | $R_{ILIM} = 90.9k$ | 400 | 450 | 500 | mA | |
| | | $R_{ILIM} = 49.9k$ | 720 | 810 | 900 | | |
| | | $R_{ILIM} = 15k$ | 2400 | 2700 | 3000 | | |
| Input Over-Current Threshold | $I_{IN(OCP)}$ | | | 3 | | A | |
| Input Over-Current Blanking Time ⁽⁵⁾ | $T_{INOCBLK}$ | | | 120 | | μs | |
| Input Over-Current Recover Time ⁽⁵⁾ | $T_{INRECVR}$ | | | 100 | | ms | |
| Terminal Battery Voltage | V_{BATT_FULL} | MP2635 | VB=GND | 3.582 | 3.6 | 3.618 | V |
| | | | VB=floating or logic HIGH | 4.179 | 4.2 | 4.221 | |
| | | MP2635B | VB= floating or logic HIGH | 4.179 | 4.2 | 4.221 | |
| | | | VB=GND | 4.328 | 4.35 | 4.372 | |
| Recharge Threshold | V_{RECH} | MP2635 | VB=GND | 3.39 | 3.44 | 3.49 | V |
| | | | VB=floating or logic HIGH | 3.95 | 4.01 | 4.07 | |
| | | MP2635B | VB= floating or logic HIGH | 3.95 | 4.01 | 4.07 | |
| | | | VB=GND | 4.091 | 4.153 | 4.215 | |

ELECTRICAL CHARACTERISTICS (continued)
 $V_{IN} = 5.0V$, $T_A = 25^\circ C$, unless otherwise noted.

| Parameter | Symbol | Condition | Min | Typ | Max | Units | |
|--|-----------------|--|---------------------------|--------|-------|------------------|---|
| Recharge Threshold Hysteresis | | | | 200 | | mV | |
| Battery Over Voltage Threshold | | | | 103.3% | | V_{BATT_FULL} | |
| Constant Charge (CC) Current | I_{CC} | $RS1 = 40m\Omega$, $R_{ISET} = 69.8k$ | 900 | 1000 | 1100 | mA | |
| | | $RS1 = 40m\Omega$, $R_{ISET} = 34.9k$ | 1800 | 2000 | 2200 | | |
| Trickle Charge Current | I_{TC} | | | 230 | | mA | |
| Trickle Charge Voltage Threshold | V_{BATT_TC} | MP2635 | VB=GND | 2.47 | 2.57 | 2.67 | V |
| | | | VB=floating or logic HIGH | 2.9 | 3 | 3.1 | |
| | | MP2635B | VB=GND | 3.003 | 3.107 | 3.21 | |
| | | | VB=floating or logic HIGH | 2.9 | 3 | 3.1 | |
| Trickle Charge Hysteresis | | | | 200 | | mV | |
| Termination Charge Current | I_{BF} | $RS1 = 40m\Omega$, $R_{ISET}=69.8k$ | 2.5% | 10% | 17.5% | I_{CC} | |
| | | $RS1 = 40m\Omega$, $R_{ISET}=34.9k$ | 5% | 10% | 15% | I_{CC} | |
| Input-Voltage-Regulation Reference | V_{REG} | | 1.18 | 1.2 | 1.22 | V | |
| Boost Mode | | | | | | | |
| SYS Voltage Range | | | 4.2 | | 5.6 | V | |
| Feedback Voltage | | | 1.18 | 1.2 | 1.22 | V | |
| Feedback Input Current | | $V_{FB}=1V$ | | | 200 | nA | |
| Boost SYS Over-Voltage Protection Threshold | $V_{SYS(OVP)}$ | Threshold over V_{SYS} to turn off the converter during boost mode | 5.8 | 6 | 6.2 | V | |
| SYS Over Voltage Protection Threshold Hysteresis | | V_{SYS} falling from $V_{SYS(OVP)}$ | | 125 | | mV | |
| Boost Quiescent Current | | $I_{SYS} = 0$, MODE = 5V | | | 1.4 | mA | |
| Programmable Boost Output Current Limit Accuracy | I_{OLIM} | $RS1 = 40m\Omega$, $R_{OLIM} = 100k$ | 0.896 | 1.12 | 1.344 | A | |
| Programmable Boost Output Current ⁽⁵⁾ | | $RS1 = 50m\Omega$, $R_{OLIM} = 59k$ | 1.5 | | | A | |
| SYS Over-Current Blanking Time ⁽⁵⁾ | $T_{SYSOCBLK}$ | | | 120 | | μs | |
| SYS Over-Current Recover Time ⁽⁵⁾ | $T_{SYSRECVR}$ | | | 1 | | ms | |
| Weak-Battery Threshold | $V_{BATT(LOW)}$ | During boosting | | 2.5 | | V | |
| | | Before Boost starts | | 2.9 | 3.05 | V | |
| Sleep Mode | | | | | | | |
| Battery Leakage Current | $I_{LEAKAGE}$ | $V_{BATT} = 4.2V$, SYS Float, $V_{IN} = 0V$, MODE = 0V | | 15 | 30 | μA | |

ELECTRICAL CHARACTERISTICS (continued)
 $V_{IN} = 5.0V$, $T_A = 25^{\circ}C$, unless otherwise noted.

| Parameter | Symbol | Condition | Min | Typ | Max | Units | |
|--|--------|--|-----|------|-----|-----------|-------------|
| Indication and Logic | | | | | | | |
| ACOK, CHG, BOOST pin output low voltage | | Sinking 1.5mA | | | 400 | mV | |
| ACOK, CHG, BOOST pin leakage current | | Connected to 5V | | | 1 | μA | |
| NTC and Time-out Fault Blinking Frequency ⁽⁵⁾ | | $C_{TMR} = 0.1\mu F$, $I_{CHG} = 1A$ | | 13.7 | | Hz | |
| EN Input Logic Low Voltage | | | | | 0.4 | V | |
| EN Input High Voltage | | | 1.4 | | | V | |
| Mode Input Logic Low Voltage | | | | | 0.4 | V | |
| Mode Input Logic High Voltage | | | 1.4 | | | V | |
| Protection | | | | | | | |
| Trickle Charge Time | | $C_{TMR}=0.1\mu F$, remains in TC Mode, $I_{CHG}= 1A$ | | 60 | | Min | |
| Total Charge Time | | $C_{TMR}=0.1\mu F$, $I_{CHG}= 1A$ | | 360 | | Min | |
| NTC Low Temp, Rising Threshold | | $R_{NTC}=NCP18XH103(0^{\circ}C)$ | 65% | 66% | 67% | V_{SYS} | |
| NTC Low Temp, Rising Threshold Hysteresis | | | | 1% | | | |
| NTC High Temp, Rising Threshold | | $R_{NTC}=NCP18XH103(50^{\circ}C)$ | 34% | 35% | 36% | | |
| NTC High Temp, Rising Threshold Hysteresis | | | | 1% | | | |
| Charging Current Foldback Threshold ⁽⁵⁾ | | Charge Mode | | 120 | | | $^{\circ}C$ |
| Thermal Shutdown Threshold ⁽⁵⁾ | | | | 150 | | | $^{\circ}C$ |

Notes:

5) Guaranteed by design.

TYPICAL CHARACTERISTICS

MP2635, $C_{IN}=C_{BATT}=C_{SYS}=C_3=22\mu F$, $C_1=C_2=1\mu F$, $L_1=4.7\mu H$, $R_{S1}=50m\Omega$, $C_4=C_{TMR}=0.1\mu F$, Battery Simulator, unless otherwise noted.

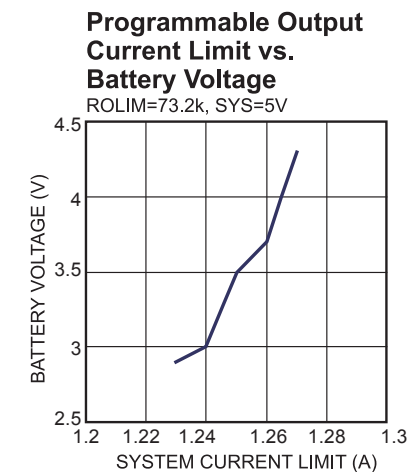
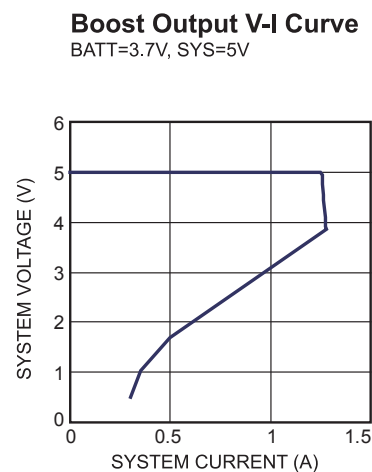
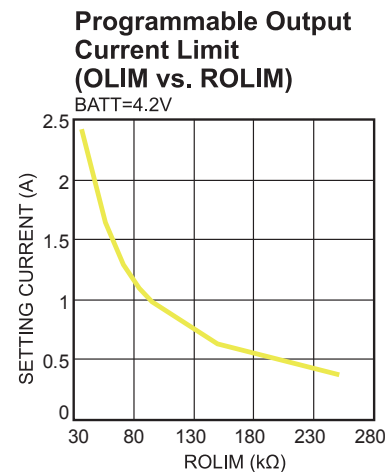
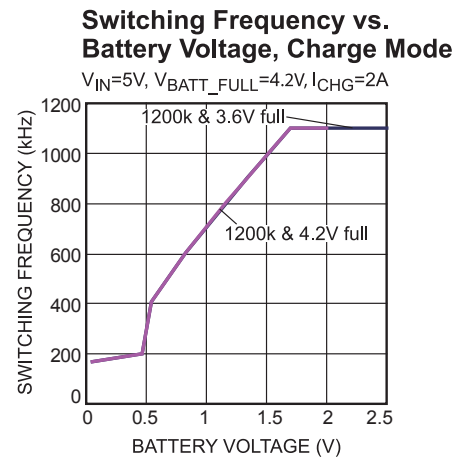
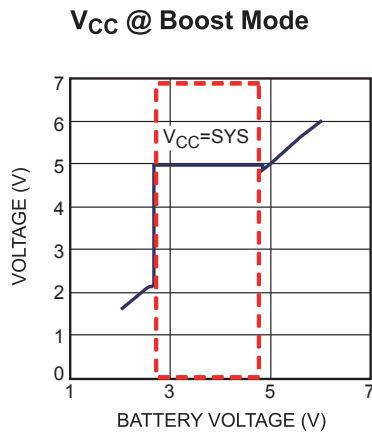
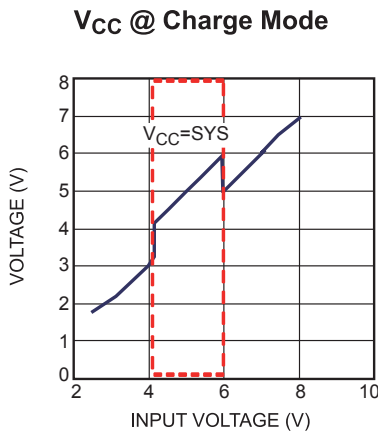
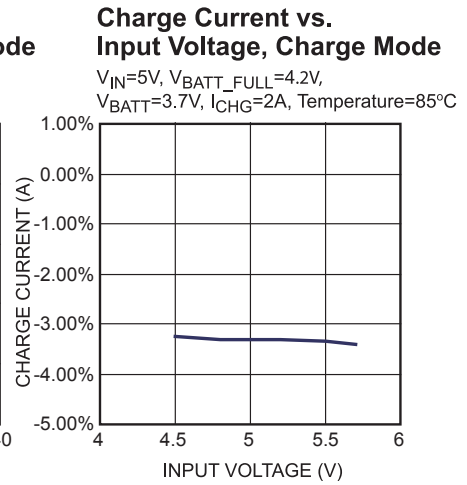
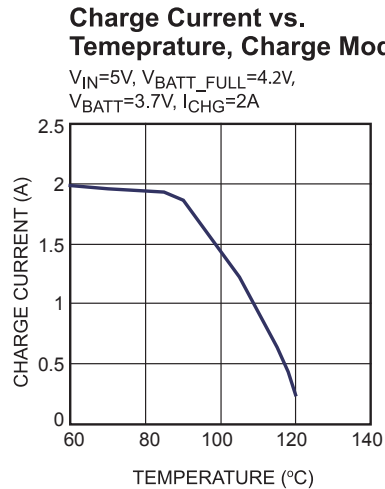
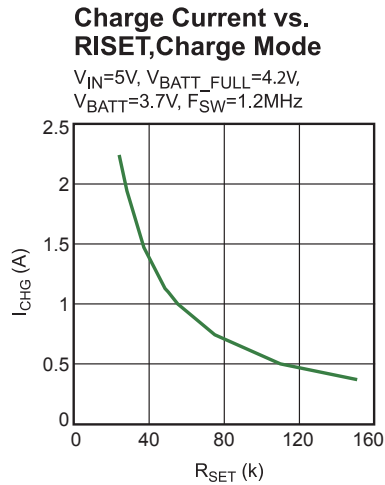

TYPICAL PERFORMANCE CHARACTERISTICS

MP2635, For Charge Mode: $V_{IN}=5V$, $I_{CHG}=1.5A$, $L_{IN_LIM}=2.7A$, $I_{SYS}=0A$

For Boost: $BATT=3.7V$, $SYS_SET=5V$, $OLIM=1.4A$

$C_{IN}=C_{BATT}=C_{SYS}=C3=22\mu F$, $C1=C2=1\mu F$, $L1=4.7\mu H$, $RS1=50m\Omega$, $C4=C_{TMR}=0.1\mu F$, $RILIM=15k\Omega$, $RISSET=28k\Omega$, $ROLIM=63.4k\Omega$, $BATT_FULL=4.2V$, $F_S=1.2MHz$, Battery Simulator, unless otherwise noted.

Battery Charge Curve

$V_{BATT_FULL} = 4.2V$

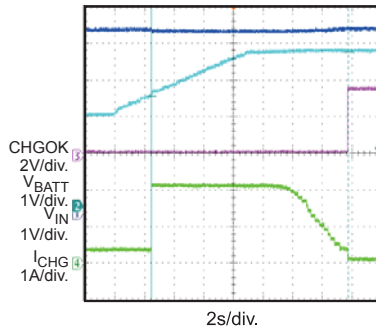

Auto Recharge

$V_{BATT_FULL} = 4.2V$

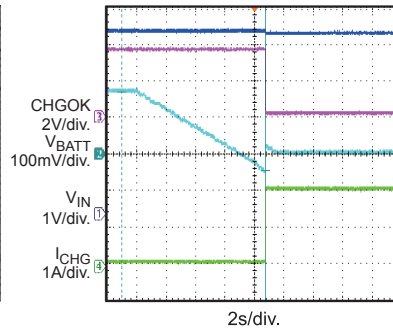

Battery Float Steady State

$V_{BATT_FULL} = 4.2V$

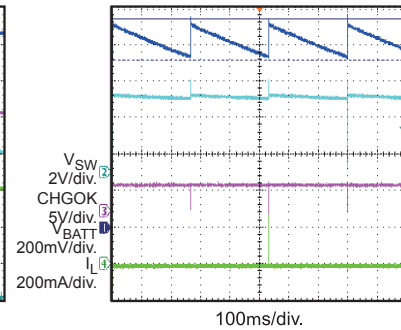

TC Charge Steady State

$V_{BATT_FULL} = 4.2V$, $V_{BATT} = 2V$, $F_{SW} = 600kHz$

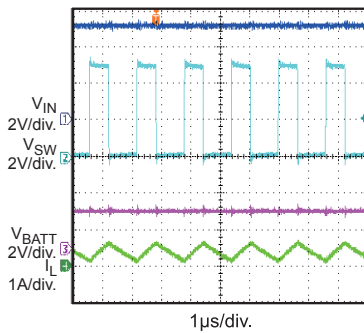

CC Charge Steady State

$V_{BATT_FULL} = 4.2V$, $V_{BATT} = 3.7V$, $F_{SW} = 600kHz$

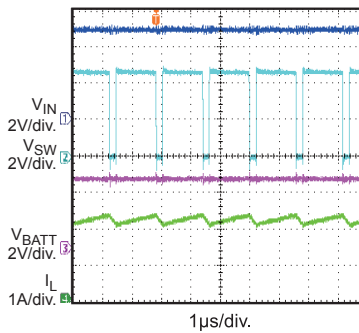

CV Charge Steady State

$V_{BATT_FULL} = 4.2V$, $V_{BATT} = 4.2V$, $F_{SW} = 600kHz$

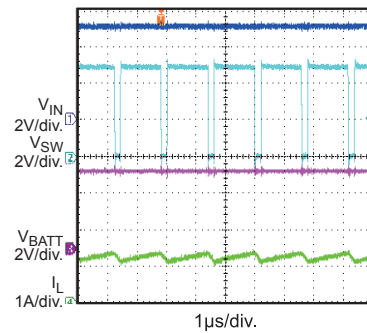

Constant Current Charge Efficiency

$V_{BATT_FULL} = 4.2V$, $V_{BATT} = 0.5-4.2V$, $F_{SW} = 600kHz$

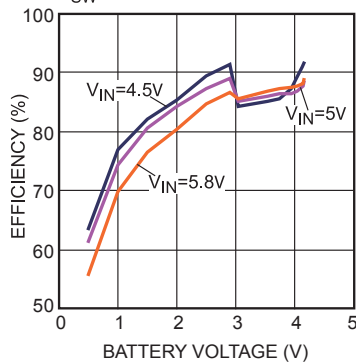

Constant Voltage Charge Efficiency

$V_{BATT_FULL} = 4.2V$, $V_{BATT} = 4.2V$, $F_{SW} = 600kHz$

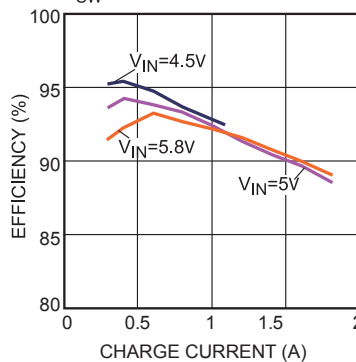

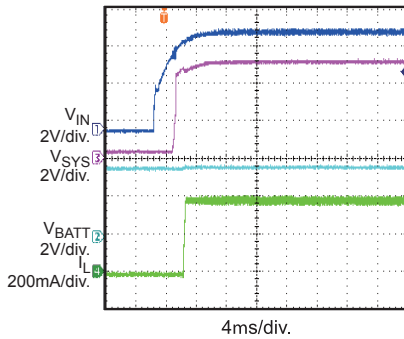
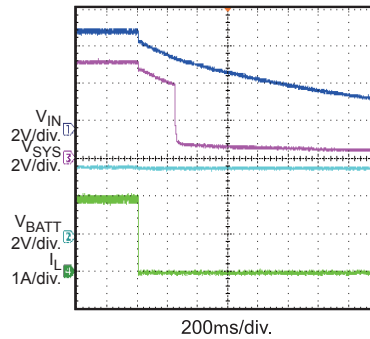
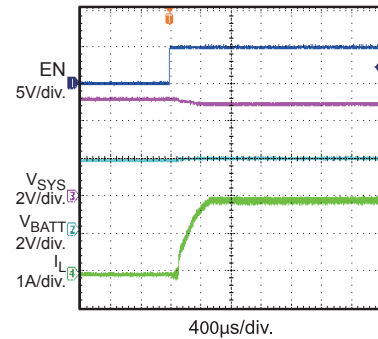
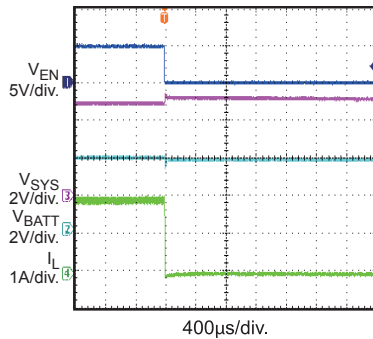
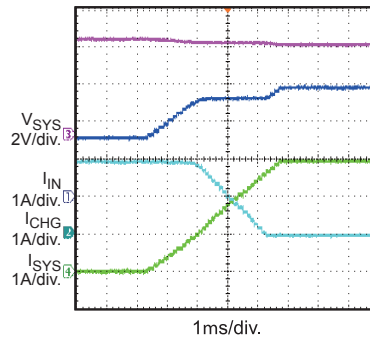
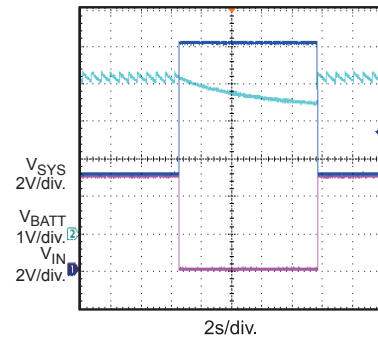
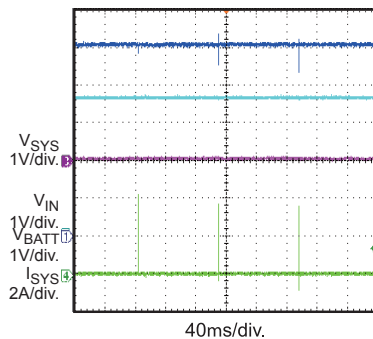
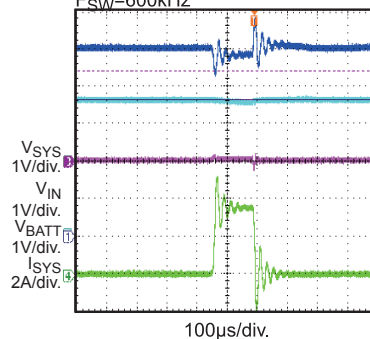
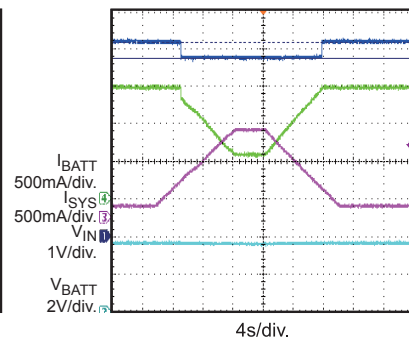
TYPICAL PERFORMANCE CHARACTERISTICS (continued)
MP2635, For Charge Mode: $V_{IN}=5V$, $I_{CHG}=1.5A$, $L_{IN_LIM}=2.7A$, $I_{SYS}=0A$
For Boost: $BATT=3.7V$, $SYS_SET=5V$, $OLIM=1.4A$
 $C_{IN}=C_{BATT}=C_{SYS}=C3=22\mu F$, $C1=C2=1\mu F$, $L1=4.7\mu H$, $RS1=50m\Omega$, $C4=C_{TMR}=0.1\mu F$, $RILIM=15k\Omega$, $RISET=28k\Omega$, $ROLIM=63.4k\Omega$, $BATT_FULL=4.2V$, $F_S=1.2MHz$, Battery Simulator, unless otherwise noted.
Power On, Charge Mode
 $V_{BATT_FULL}=4.2V$, $V_{BATT}=3.7V$,
 $I_{CHG}=2A$

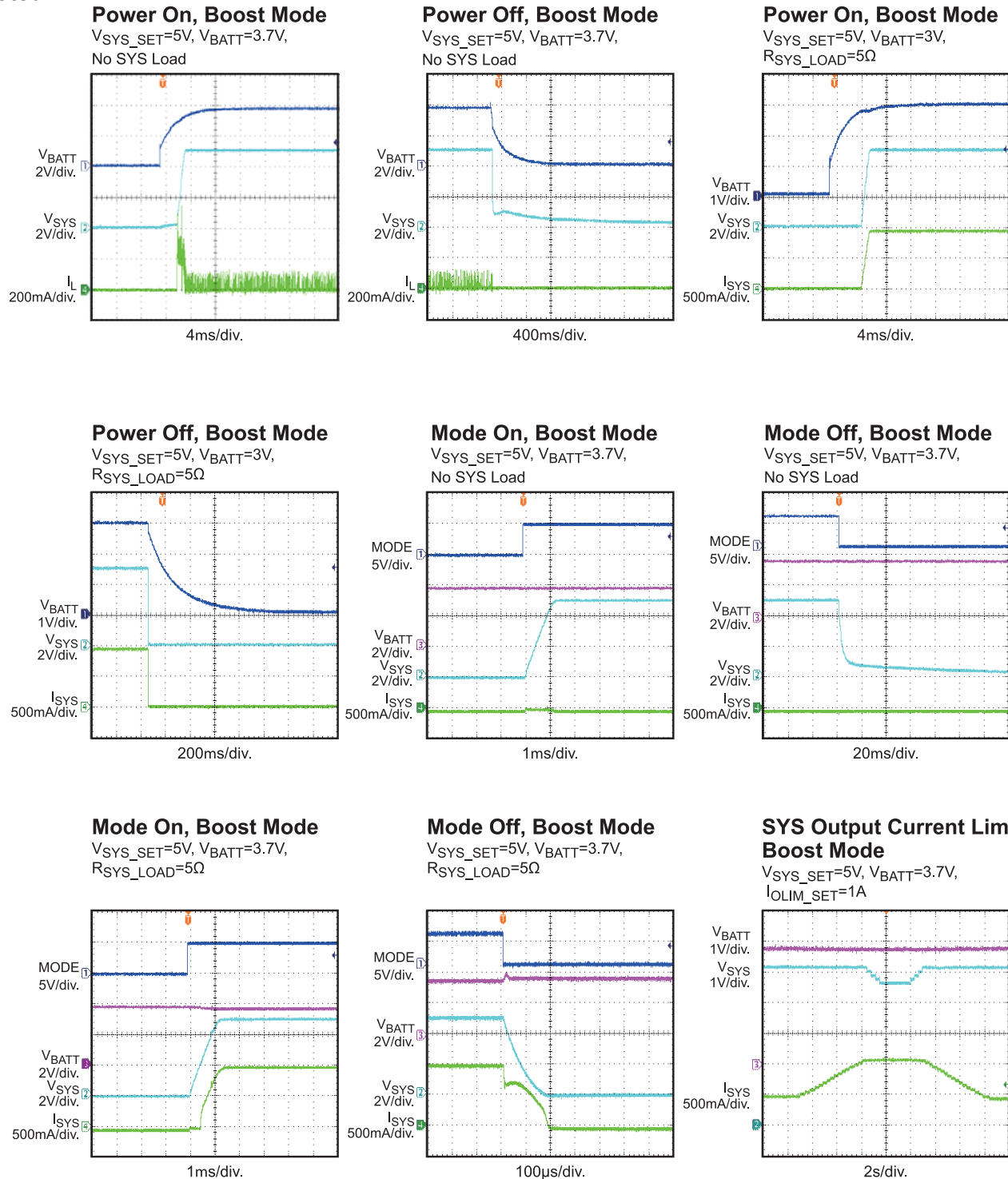
Power Off, Charge Mode
 $V_{BATT_FULL}=4.2V$, $V_{BATT}=3.7V$,
 $I_{CHG}=2A$

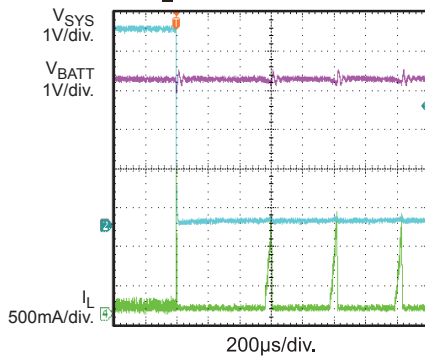
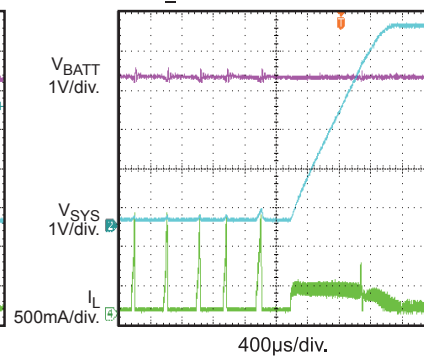
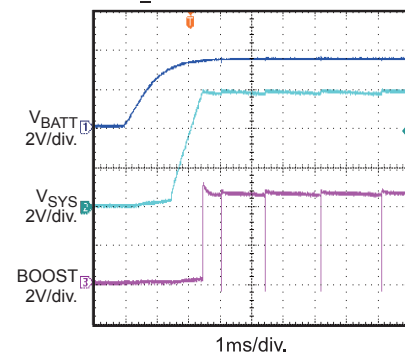
En On, Charge Mode
 $V_{BATT_FULL}=4.2V$, $V_{BATT}=3.7V$,
 $I_{CHG}=2A$

En Off, Charge Mode
 $V_{BATT_FULL}=4.2V$, $V_{BATT}=3.7V$,
 $I_{CHG}=2A$

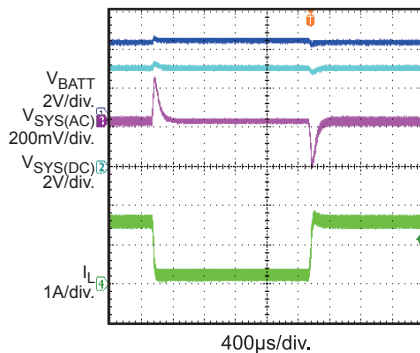
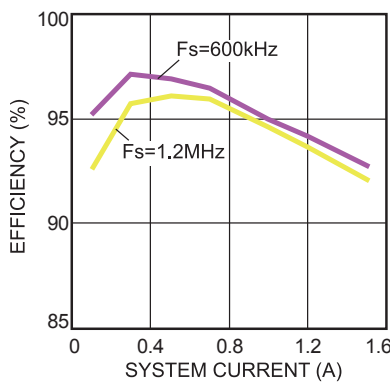
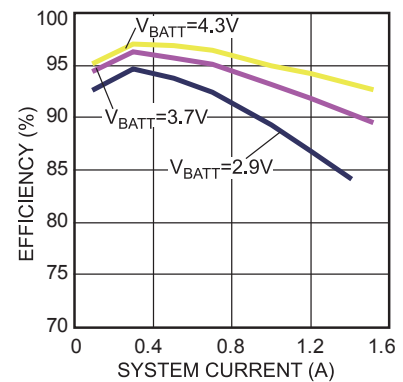
Input Current Limit, Charge Mode
 $V_{BATT_FULL}=4.2V$, $V_{BATT}=3.7V$

Input Over Voltage Protection, Charge Mode
 $V_{IN}=5V$ to $12V$, $R_{SYS_LOAD}=25\Omega$,
 Battery Float, Enabled Charge

System Short Protection
 $V_{BATT_FULL}=4.2V$, $V_{BATT}=2V$,
 $F_{SW}=600kHz$

System Short Protection Zoom In
 $V_{BATT_FULL}=4.2V$, $V_{BATT}=2V$,
 $F_{SW}=600kHz$

Input Voltage Clamp @ 4.6V
 $EN=High$, Mode=Low

TYPICAL PERFORMANCE CHARACTERISTICS (continued)
MP2635, For Charge Mode: $V_{IN}=5V$, $I_{CHG}=1.5A$, $L_{IN_LIM}=2.7A$, $I_{SYS}=0A$
For Boost: $BATT=3.7V$, $SYS_SET=5V$, $OLIM=1.4A$
 $C_{IN}=C_{BATT}=C_{SYS}=C3=22\mu F$, $C1=C2=1\mu F$, $L1=4.7\mu H$, $RS1=50m\Omega$, $C4=C_{TMR}=0.1\mu F$, $RILIM=15k\Omega$, $RISSET=28k\Omega$, $ROLIM=63.4k\Omega$, $BATT_FULL=4.2V$, $F_s=1.2MHz$, Battery Simulator, unless otherwise noted.

TYPICAL PERFORMANCE CHARACTERISTICS (continued)
MP2635, For Charge Mode: $V_{IN}=5V$, $I_{CHG}=1.5A$, $L_{IN_LIM}=2.7A$, $I_{SYS}=0A$
For Boost: $BATT=3.7V$, $SYS_SET=5V$, $OLIM=1.4A$
 $C_{IN}=C_{BATT}=C_{SYS}=C3=22\mu F$, $C1=C2=1\mu F$, $L1=4.7\mu H$, $RS1=50m\Omega$, $C4=C_{TMR}=0.1\mu F$, $RILIM=15k\Omega$, $RISSET=28k\Omega$, $ROLIM=63.4k\Omega$, $BATT_FULL=4.2V$, $F_s=1.2MHz$, Battery Simulator, unless otherwise noted.
SYS Short Circuit Entry, Boost Mode
 $V_{SYS_SET}=5V$, $V_{BATT}=3.7V$

SYS Short Circuit Recovery, Boost Mode
 $V_{SYS_SET}=5V$, $V_{BATT}=3.7V$

SYS Over Voltage Protection, Boost Mode
 $V_{SYS_SET}=6.5V$, $V_{BATT}=3.7V$

Load Transient Response

EN= Low, Mode= High

 $I_{SYS} = 100mA$ to $1A$ with Slew Rate $2.5A/\mu s$

Boost Efficiency
 $BATT=4.3V$, $SYS=5V$

Boost Efficiency
 $SYS=5V$, $F_s=600kHz$

PIN FUNCTIONS

| Pin # | Name | Description |
|--------|---------------------------|--|
| 1 | FREQ | Connect to GND to program the operating frequency to 600kHz. Leave floating or connect to HIGH to program the operating frequency to 1.2MHz. |
| 2 | VIN | Adapter Input. Place a bypass capacitor close to this pin to prevent large input voltage spikes. |
| 3 | VCC | Internal Circuit Power Supply. Bypass to GND with a 100nF ceramic capacitor. This pin can not carry external load higher than 5mA. |
| 4 | ILIM | Input Current Set. Connect to GND with an external resistor to program input current limit in charge mode. |
| 5 | PWIN | AC Input Detect. Detect the presence of valid input power. |
| 6 | TMR | Oscillator Period Timer. Connect a timing capacitor between this pin and GND to set the oscillator period. Short to GND to disable the Timer function. |
| 7 | REG | Input Voltage Feedback for input voltage regulation loop. Connect to tap of an external resistor divider from VIN to GND to program the input voltage regulation. Once the voltage at REG pin drops to the inner threshold, the charge current is reduced to maintain the input voltage at the regulation value. |
| 8 | $\overline{\text{ACOK}}$ | Valid Input Supply Indicator. Logic LOW on this pin indicates the presence of a valid power supply. |
| 9 | FB | System voltage feedback input. |
| 10 | NTC | Negative Temperature Coefficient (NTC) Thermistor. |
| 11 | ISET | Charge Current Set. Connect an external resistor to GND to program the charge current. |
| 12 | OLIM | Programmable Output-Current Limit for boost mode. Connect an external resistor to GND to program the system current in boost mode. |
| 13 | AGND | Analog Ground |
| 14 | VB | MP2635 Programmable Battery-Full Voltage. Connect to GND for 3.6V. Leave floating or connect to logic HIGH for 4.2V |
| | | MP2635B Programmable Battery-Full Voltage. Connect to GND for 4.35V. Leave floating or connect to logic HIGH for 4.2V |
| 15 | BATT | Positive Battery Terminal / Battery Charge Current Sense Negative Input. |
| 16 | CSP | Battery Charge Current Sense Positive Input. |
| 17 | $\overline{\text{BOOST}}$ | Boost Mode indicator. Logic LOW indicates boost mode in operation. The pin becomes an open drain when the part operates in charge mode or sleep mode. |
| 18 | $\overline{\text{CHG}}$ | Charge Completion Indicator. Logic LOW indicates charge mode. The pin becomes an open drain once the charging has completed or is suspended. |
| 19 | PGND, Exposed Pad | Power Ground. Connect the exposed pad and GND pin to the same ground plane. |
| 20 | SW | Switch Output Node. |
| 21, 22 | SYS | System Output. Please make sure the enough bulk capacitors from SYS to GND. Suggest 4.7μF at least. The capacitor should be put as close as possible to SYS and GND. |
| 23 | MODE | Mode Select. Logic HIGH→boost mode. Logic LOW→sleep mode. Active only when $\overline{\text{ACOK}}$ is HIGH (input power is not available). |
| 24 | EN | Charge Control Input. Logic HIGH enables charging. Logic LOW disables charging. Active only when $\overline{\text{ACOK}}$ is low (input power is OK). |

BLOCK DIAGRAM

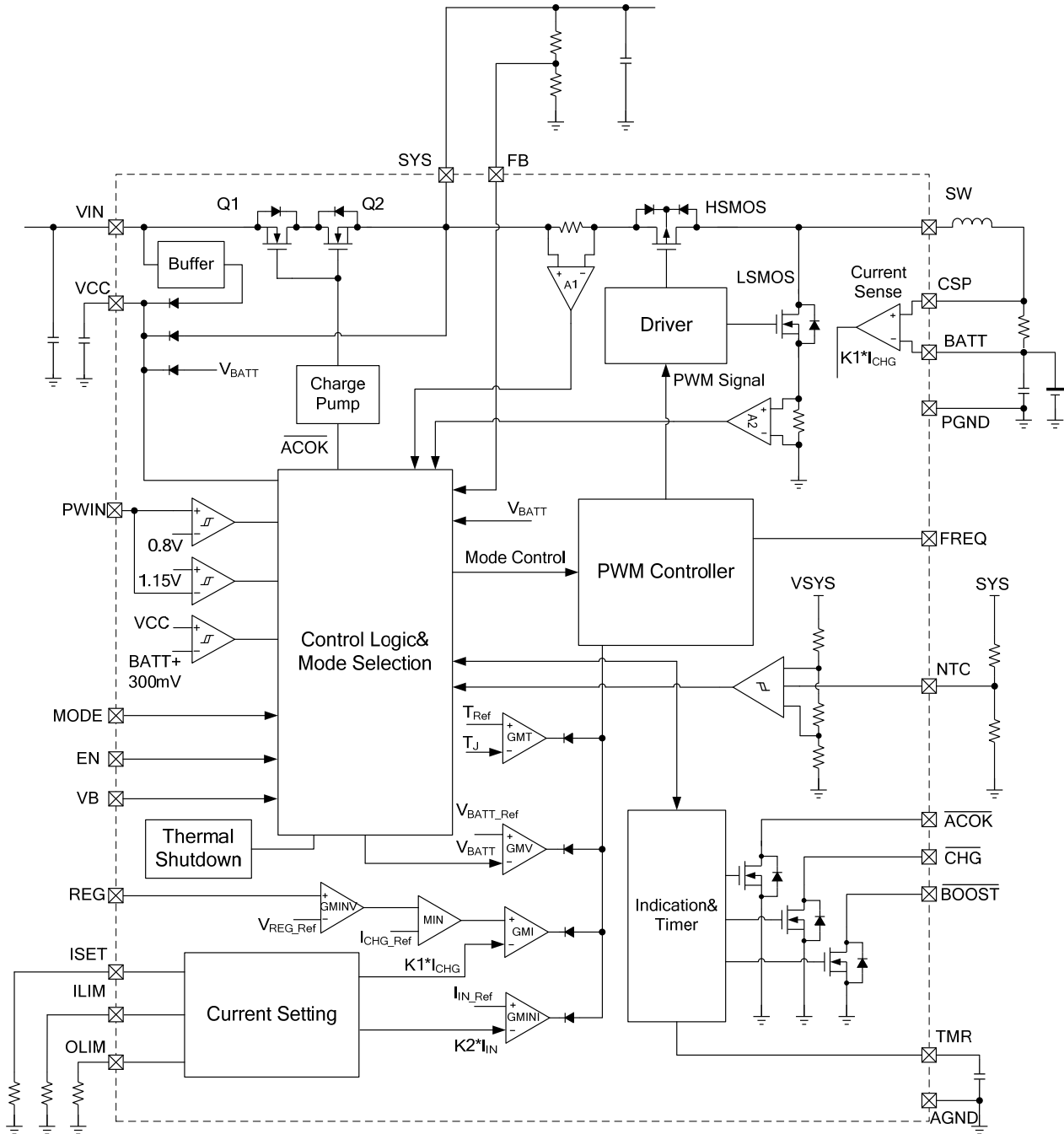

Figure 1: Functional Block Diagram in Charge Mode

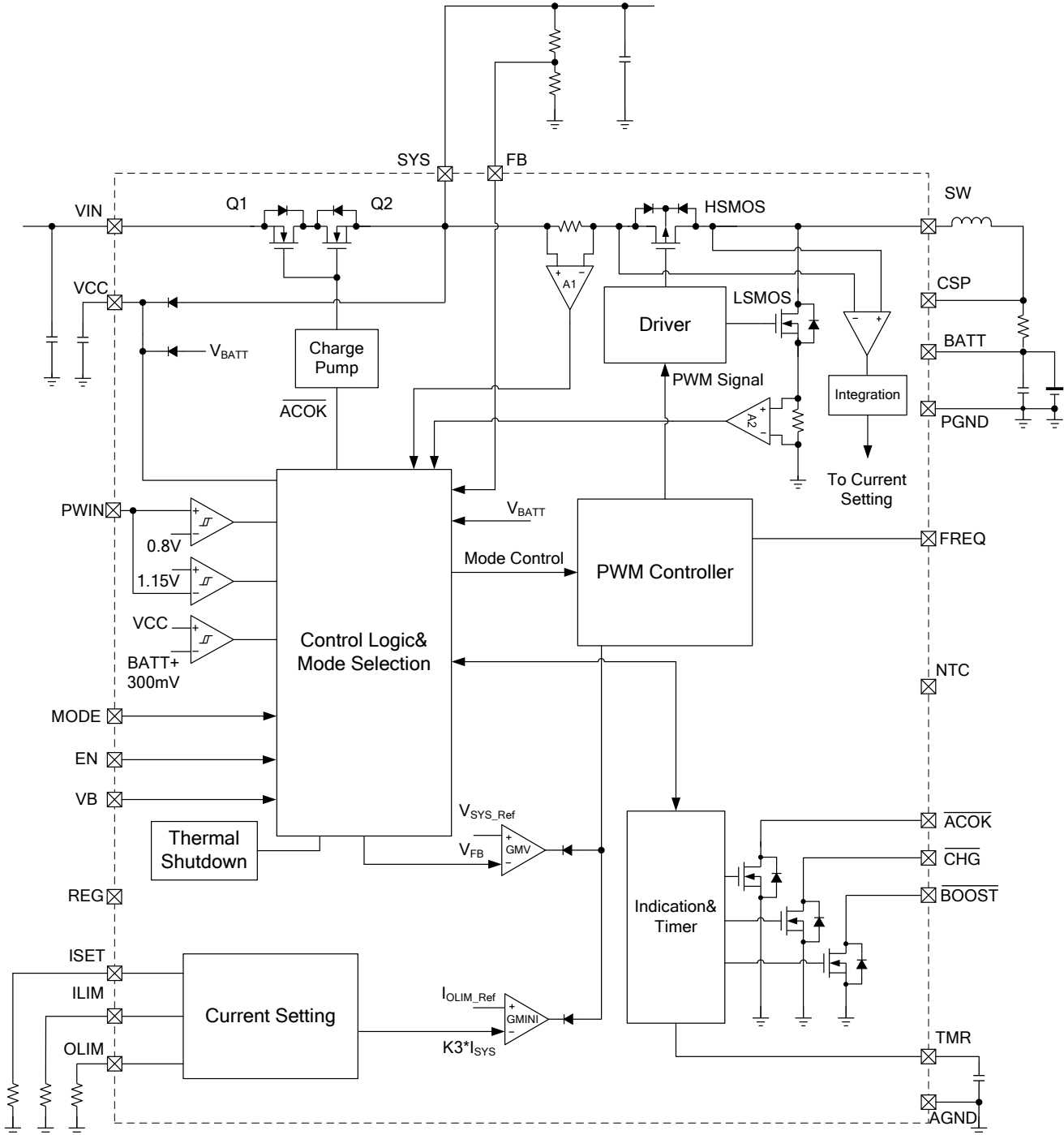

Figure 2: Functional Block Diagram in Boost Mode

OPERATION FLOW CHART

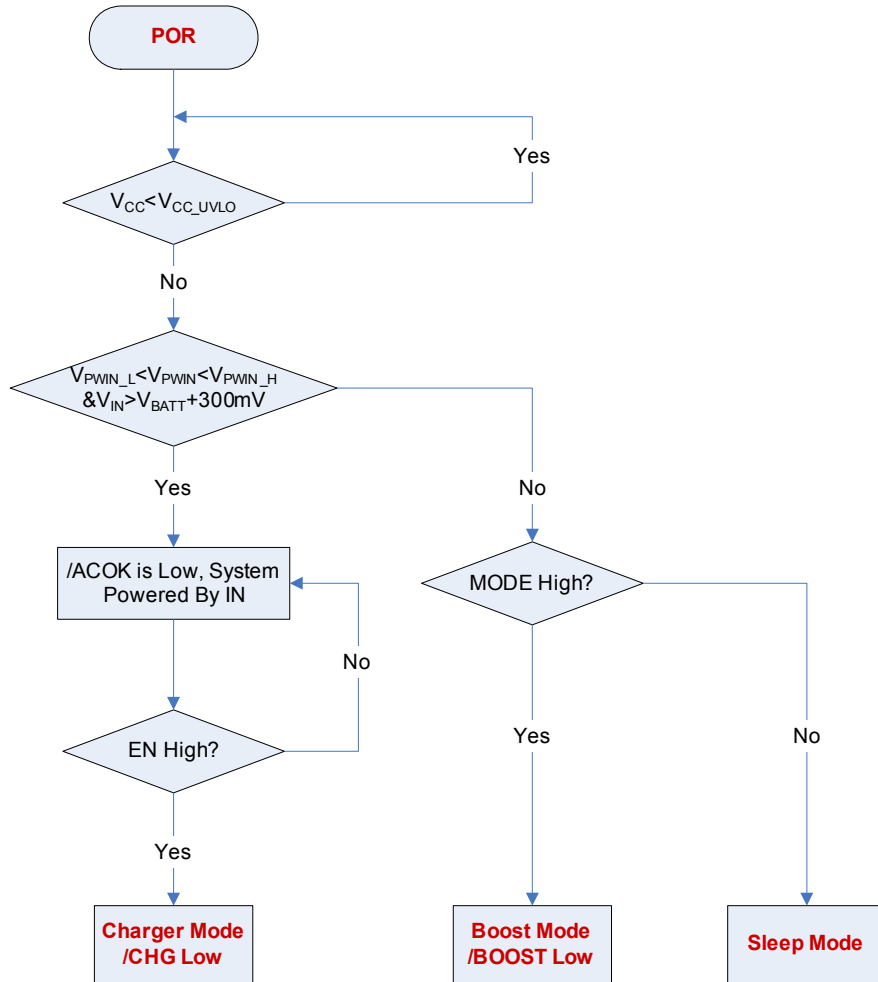

Figure 3: Mode Selection Flow Chart

OPERATION FLOW CHART (continued)

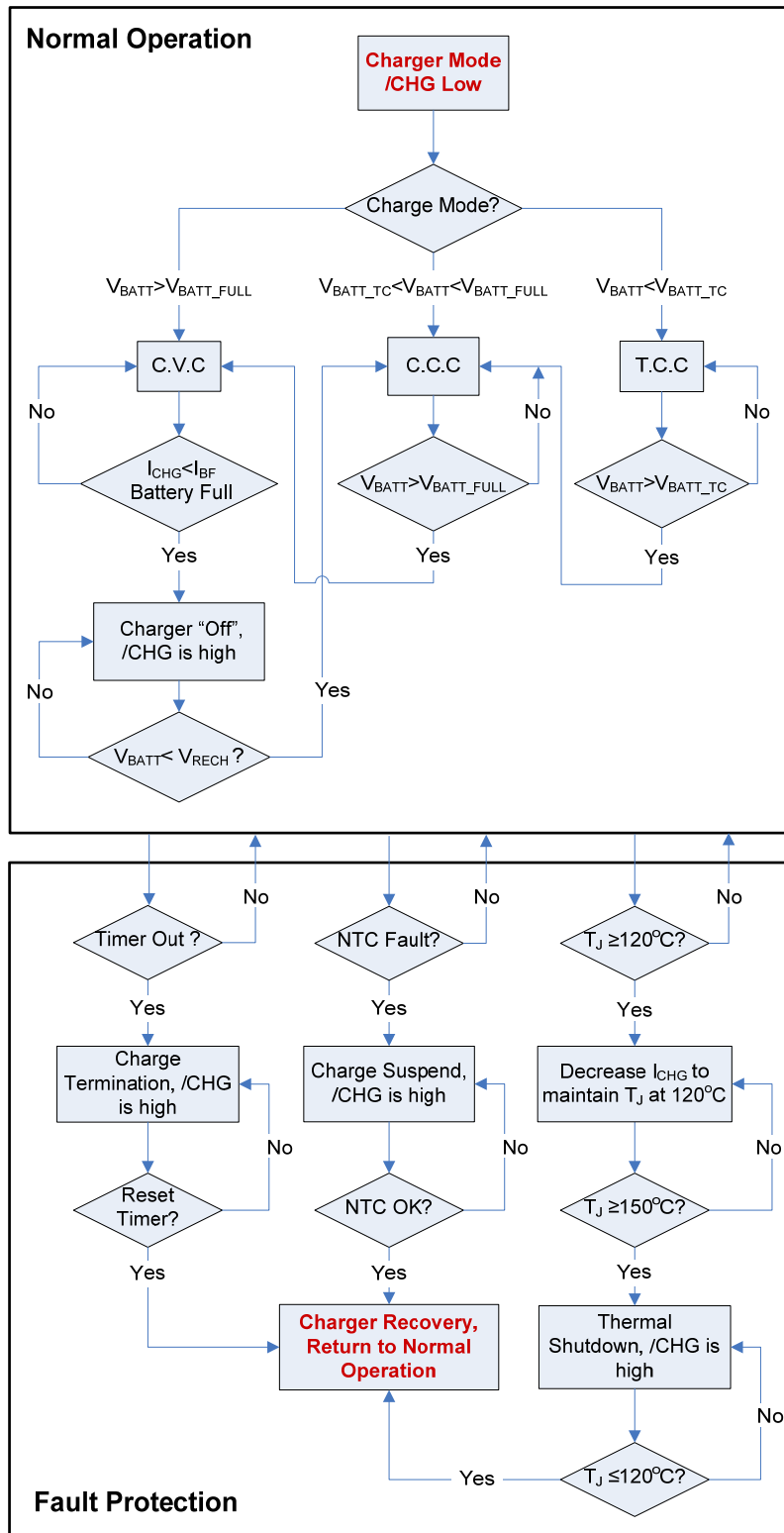

Figure 4: Normal Operation and Fault Protection in Charge Mode

OPERATION FLOW CHART (continued)

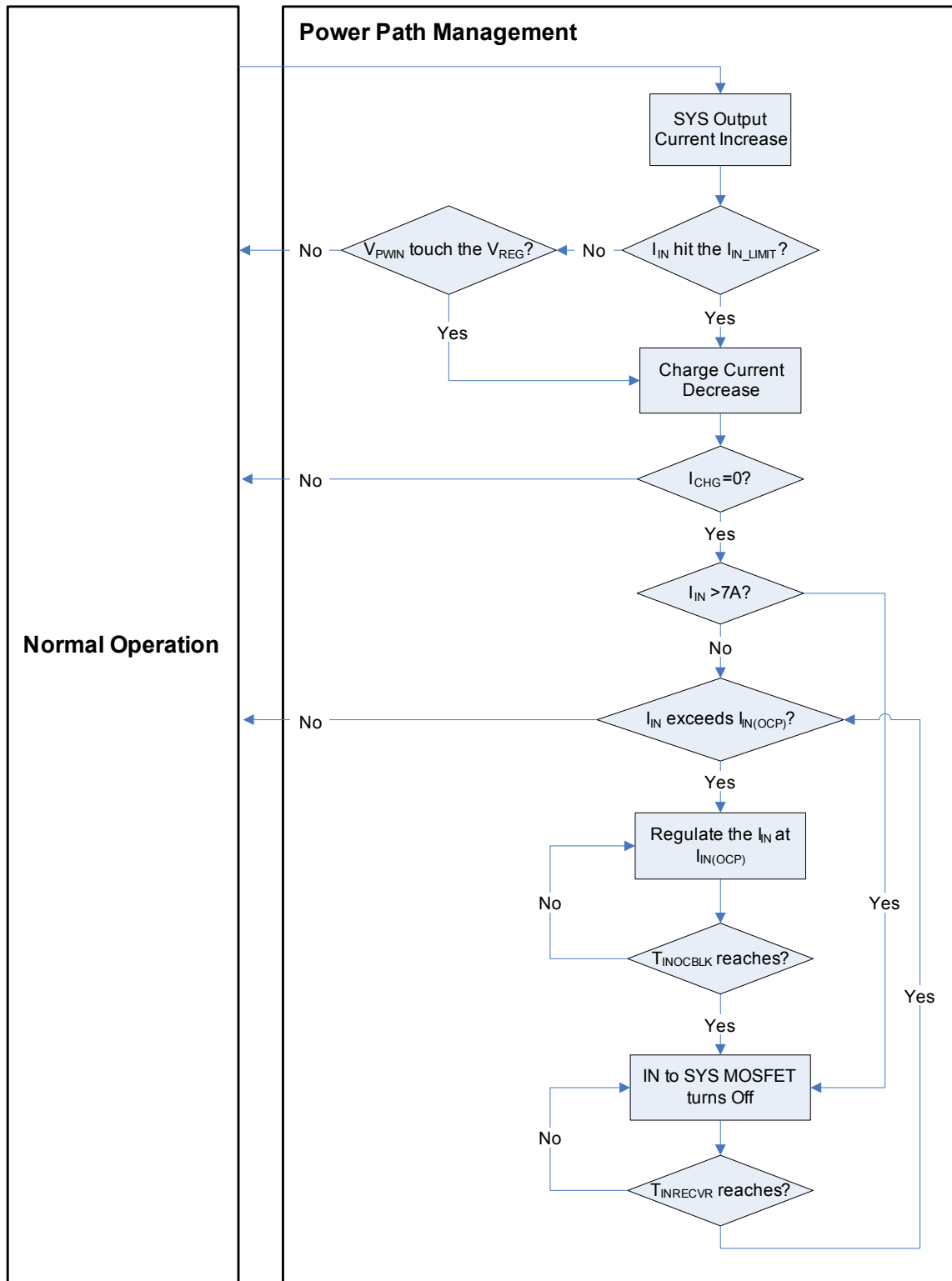

Figure 5: Power-path Management in Charge Mode

OPERATION FLOW CHART (continued)

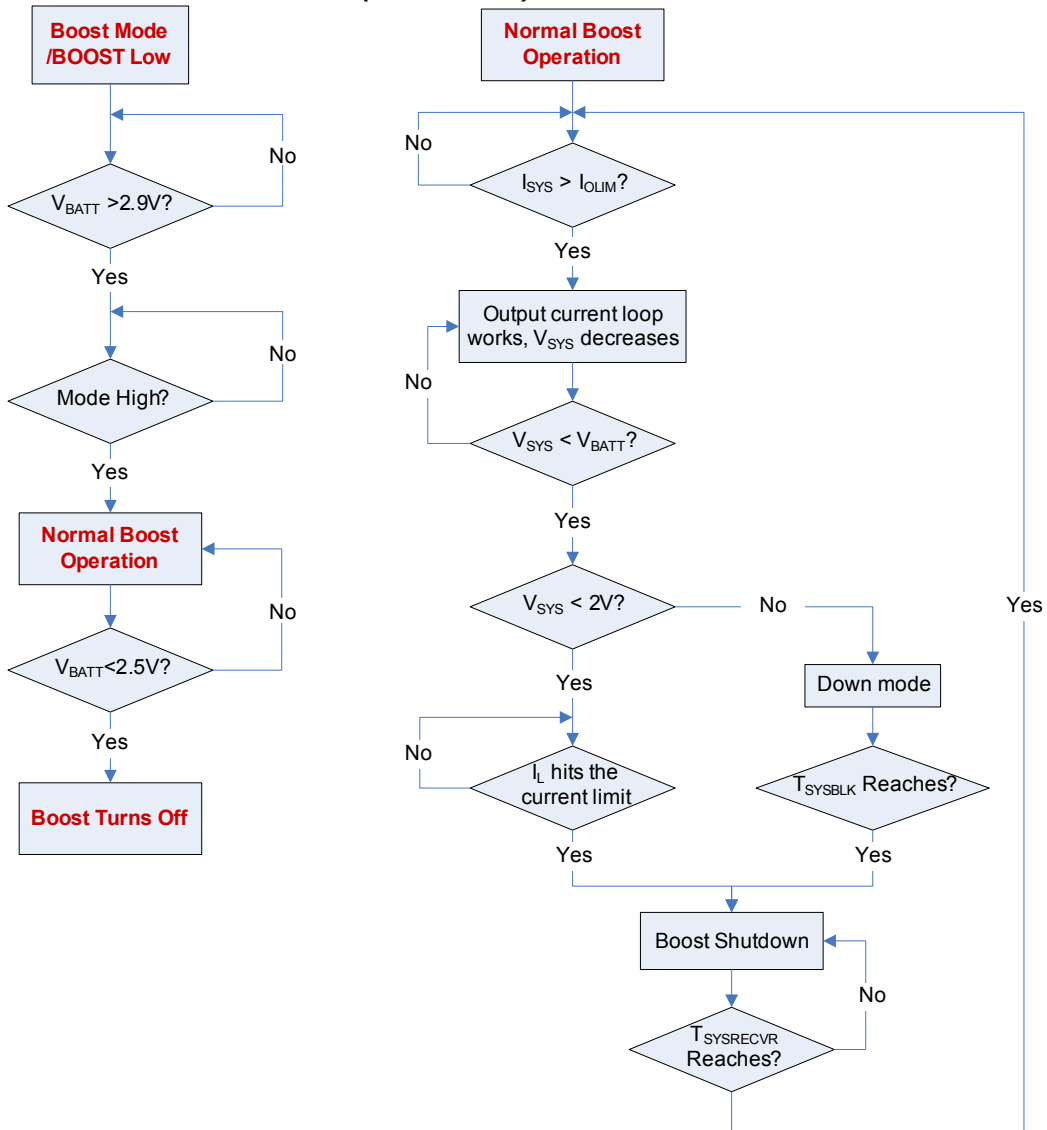

Figure 6: Operation Flow Chart in Boost Mode

START UP TIME FLOW IN CHARGE MODE

Condition: EN = 5V, Mode = 0V, /ACOK and /CHG are always pulled up to an external constant 5V

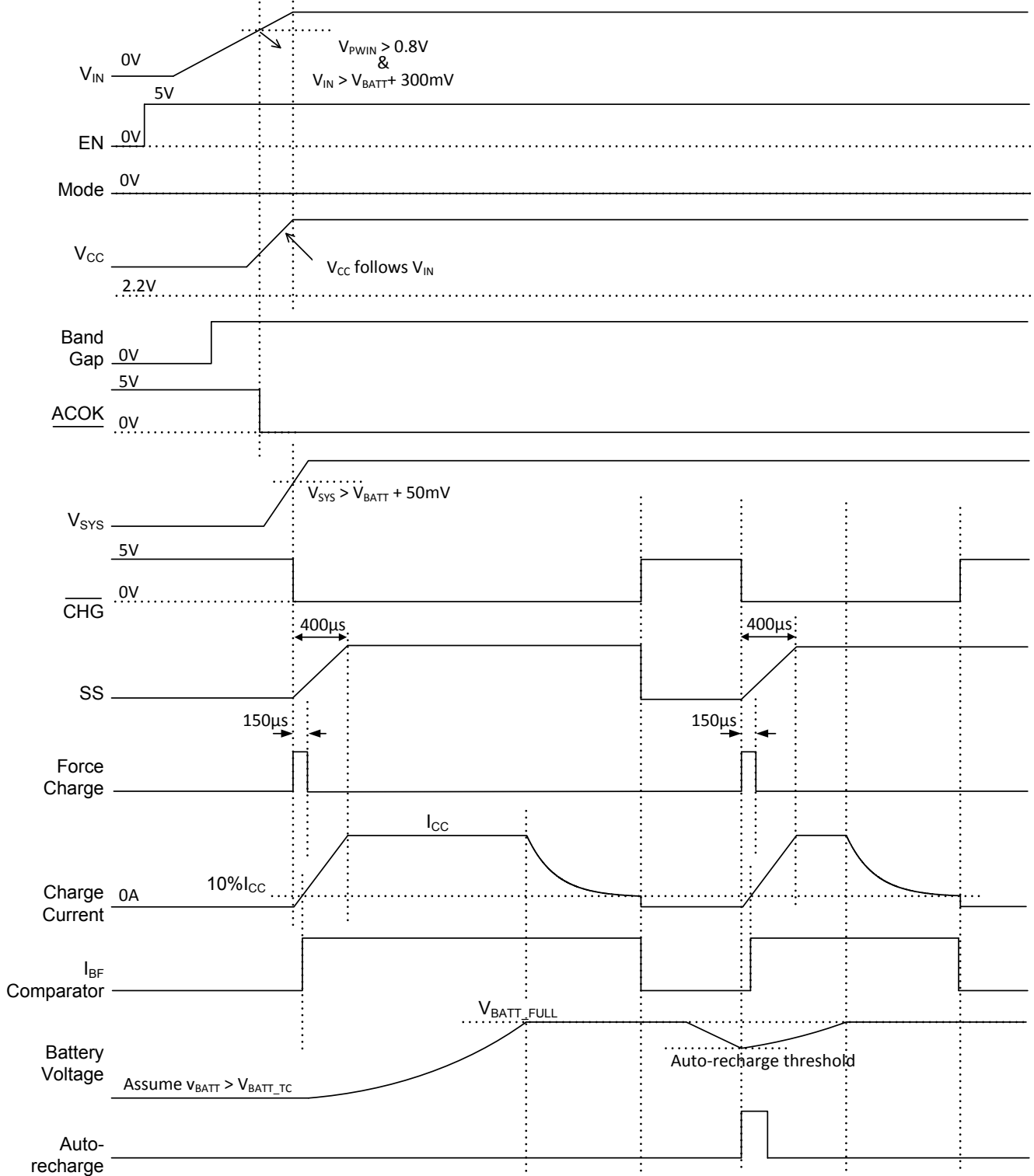

Figure 7: Input Power Start-Up Time Flow in Charge Mode

START UP TIME FLOW IN CHARGE MODE

Condition: $V_{IN} = 5V$, Mode = 0V, /ACOK and /CHG are always pulled up to an external constant 5V.

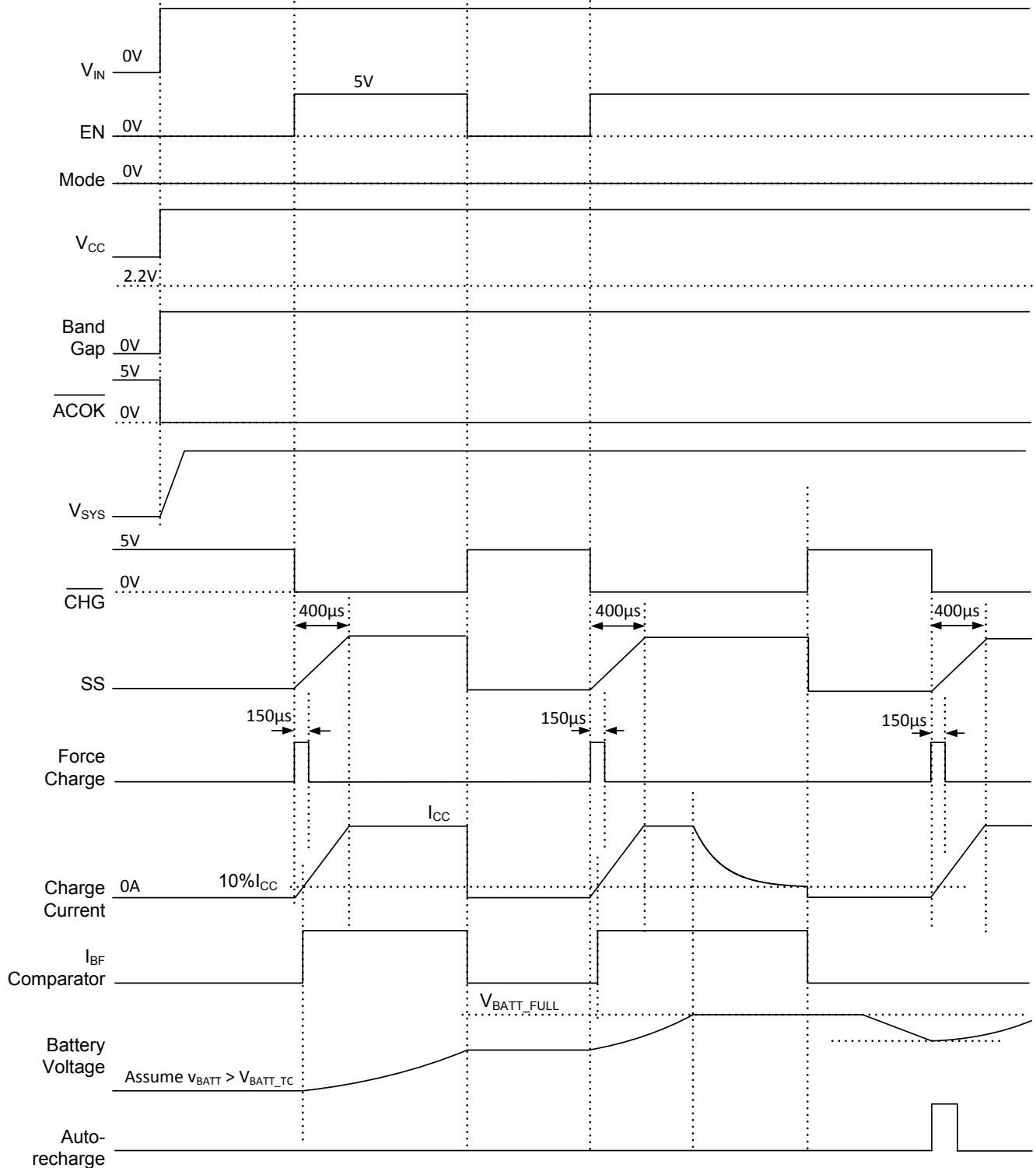

Figure 8: EN Start-Up Time Flow in Charge Mode

START UP TIME FLOW IN BOOST MODE

Condition: $V_{IN} = 0V$, Mode = 5V, /Boost is always pulled up to an external constant 5V.

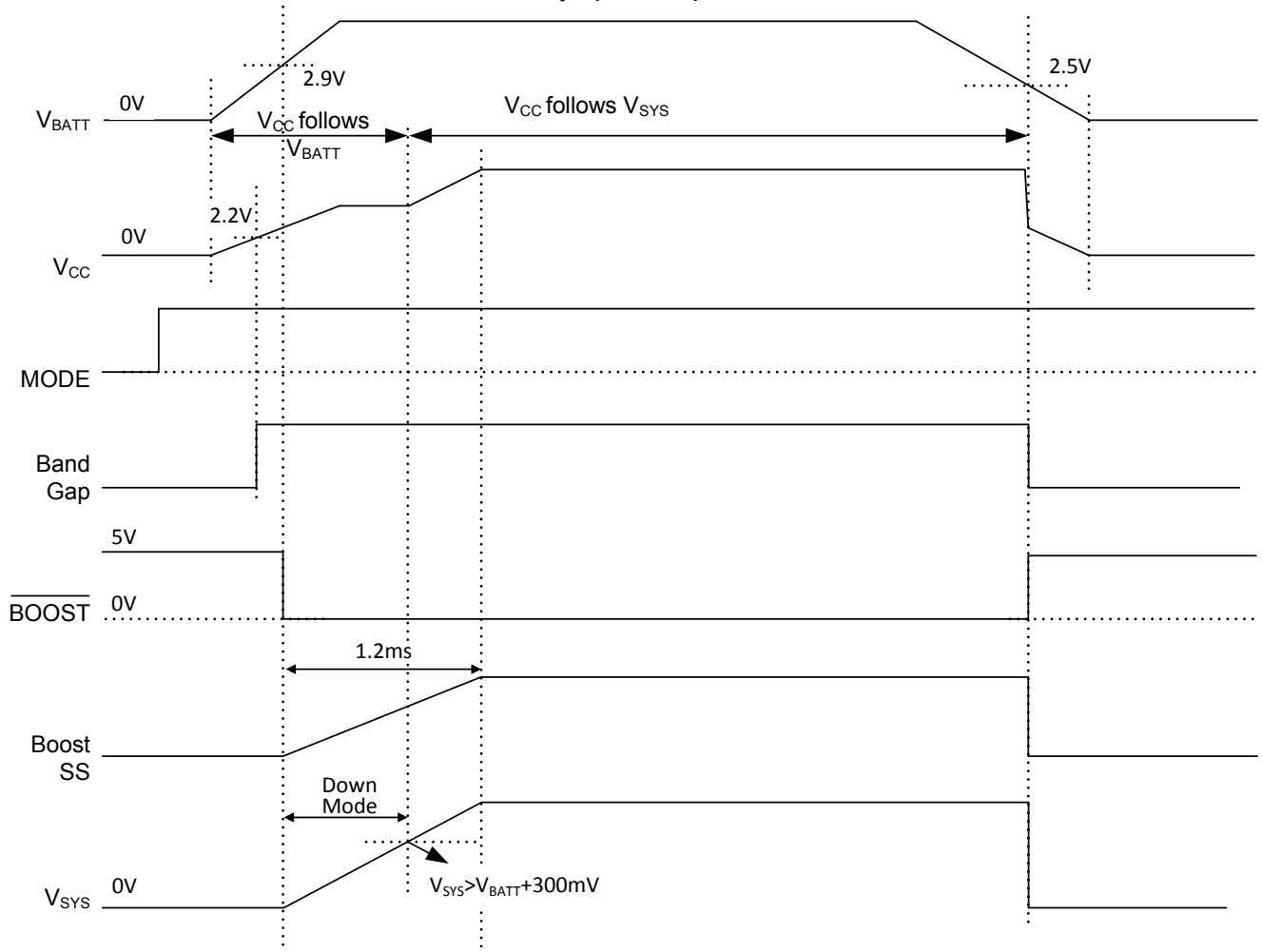

Figure 9: Battery Power Start-Up Time Flow in Boost Mode

START UP TIME FLOW IN BOOST MODE

Condition: $V_{IN} = 0V$, /Boost is always pulled up to an external constant 5V.

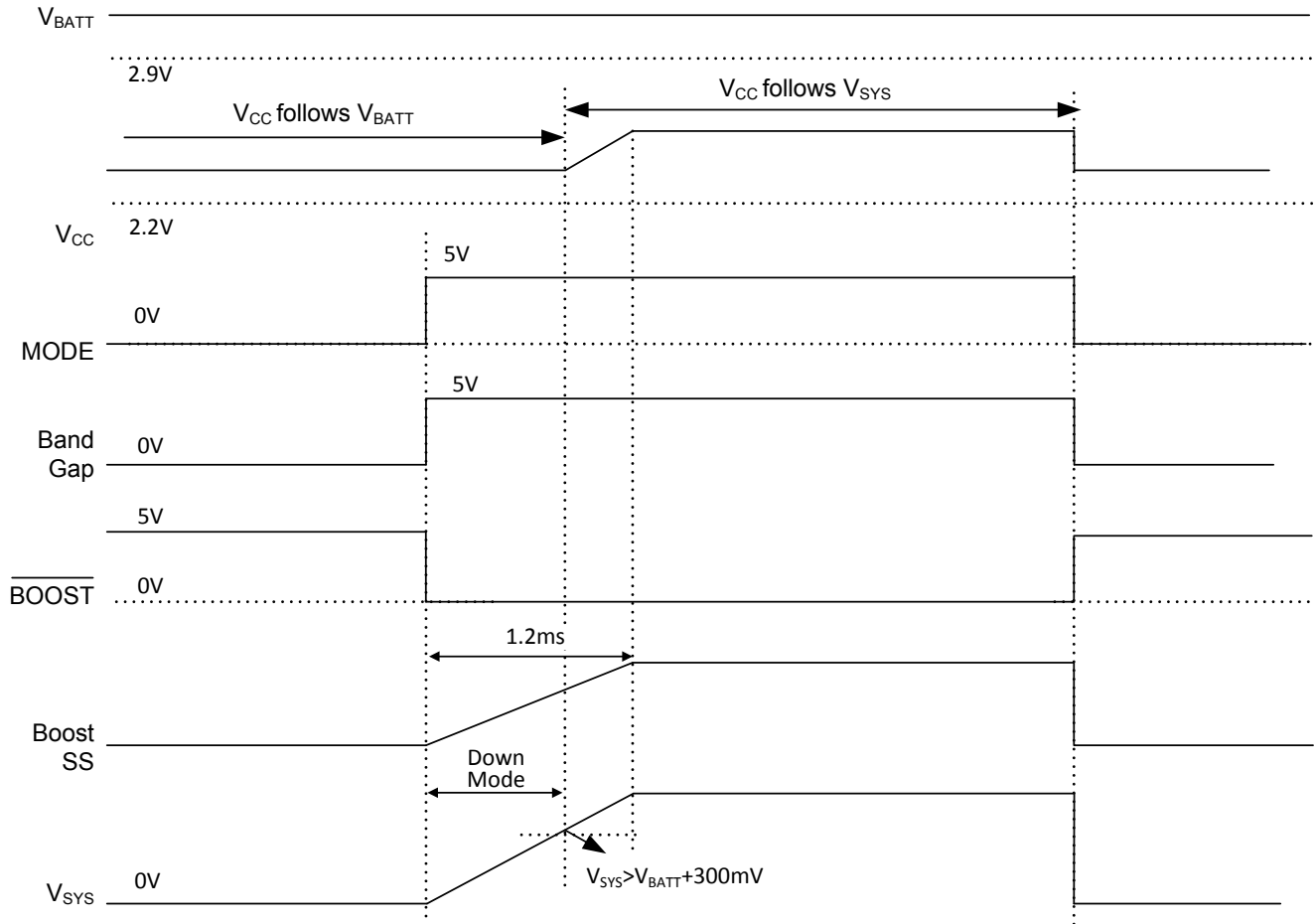

Figure 10: Mode Start-Up Time Flow in Boost Mode

OPERATION

INTRODUCTION

The MP2635 is a highly-integrated, synchronous, switching charger with bi-directional operation for a boost function that can step-up the battery voltage to power the system. Depending on the VIN value, it operates in one of three modes: charge mode, boost mode and sleep mode. In charge mode, the MP2635 supports a precision Li-ion or Li-polymer charging system for single-cell applications. In boost mode, MP2635 boosts the battery voltage to V_{SYS} to power higher-voltage systems. In sleep mode, the MP2635 stops charging or boosting and operates at a low current from the input or the battery to reduce power consumption when the IC isn't operating. The MP2635 monitors VIN to allow smooth transition between different modes of operation.

CHARGE MODE OPERATION

Charge Cycle (Trickle Charge → CC Charge → CV Charge)

In charge mode, the MP2635 has five control loops to regulate the input current, input voltage, charge current, charge voltage, and device junction temperature. It charges the battery in three phases: trickle current (TC), constant current (CC), and constant voltage (CV). While charging, all four loops are active but only one determines the IC behavior. Figure 11(a) shows a typical battery charge profile. The charger stays in TC charge mode until the battery voltage reaches a TC-to-CC threshold. Otherwise the charger enters CC charge mode. When the battery voltage rises to the CV-mode threshold, the charger operates in constant voltage mode. Figure 11(b) shows a typical charge profile when the input-current-limit loop dominates during the CC charge mode, and in this case the charge current exceeds the input current, resulting in faster charging than a traditional linear solution that is well-suited for USB applications.

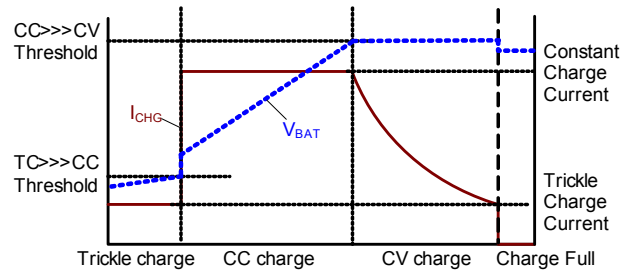

a) Without input current limit

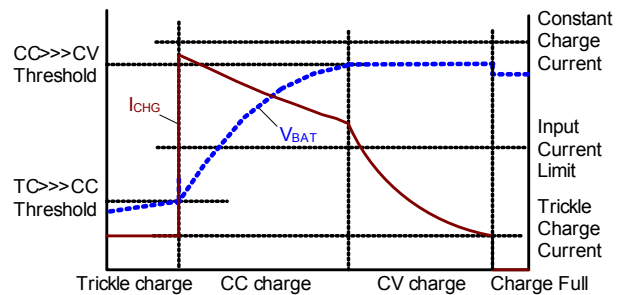

b) With input current limit

Figure 11: Typical Battery Charge Profile

Auto-Recharge

Once the battery charge cycle completes, the charger remains off. During this process, the system load may consume battery power, or the battery may self discharge. To ensure the battery will not go into depletion, a new charge cycle automatically begins when the battery voltage falls below the auto-recharge threshold and the input power is present. The timer resets when the auto-recharge cycle begins.

During the off state after the battery is fully charged, if the input power re-starts or the EN signal refreshes, the charge cycle will start and the timer will reset no matter what the battery voltage is.

Battery Over-Voltage Protection

The MP2635 has battery over-voltage protection. If the battery voltage exceeds the battery over-voltage threshold, (103.3% of the battery-full voltage), charging is disabled. Under this condition, an internal current source draws a current from the BATT pin to decrease the battery voltage and protect the battery.

Timer Operation in Charge Mode

The MP2635 uses an internal timer to terminate the charging. The timer remains active during the charging process. An external capacitor between TMR and GND programs the charge cycle duration.

If charging remains in TC mode beyond the trickle-charge time, $\tau_{\text{TRICKLE_TMR}}$, charging will terminate. The following determines the length of the trickle-charge period:

$$\tau_{\text{TRICKLE_TMR}} = 60 \text{ min s} \times \frac{C_{\text{TMR}} (\mu\text{F})}{0.1 \mu\text{F}} \times \frac{1\text{A}}{I_{\text{CHG}} (\text{A})} \quad (1)$$

The maximum total charge time is:

$$\tau_{\text{TOTAL_TMR}} = 6 \text{ Hours} \times \frac{C_{\text{TMR}} (\mu\text{F})}{0.1 \mu\text{F}} \times \frac{1\text{A}}{I_{\text{CHG}} (\text{A})} \quad (2)$$

Negative Temperature Coefficient (NTC) Input for Battery Temperature Monitoring

The MP2635 has a built-in NTC resistance window comparator, which allows the MP2635 to monitor the battery temperature via the battery-integrated thermistor. Connect an appropriate resistor from V_{SYS} to the NTC pin and connect the thermistor from the NTC pin to GND. The resistor divider determines the NTC voltage depending on the battery temperature. If the NTC voltage falls outside of the NTC window, the MP2635 stops charging. The charger will then restart if the temperature goes back into NTC window range.

Input-Current Limiting in Charge Mode

The MP2635 has a dedicated pin that programs the input-current limit. The current at ILIM is a fraction of the input current; the voltage at ILIM indicates the average input current of the switching regulator as determined by the resistor value between ILIM and GND. As the input current approaches the programmed input current limit, charge current is reduced to allow priority to system power.

Use the following equation to determine the input current limit threshold,

$$I_{\text{ILIM}} = \frac{40.5(\text{k}\Omega)}{R_{\text{ILIM}} (\text{k}\Omega)} (\text{A}) \quad (3)$$

Input Over-Current Protection

The MP2635 features input over-current protection (OCP): when the input current exceeds 3A, Q2 is controlled linearly to regulate the current. If the current still exceeds 3A after a 120 μs blanking time, Q2 will turn off. A fast off function turns off Q2 quickly when the input current exceeds 7A to protect both Q1 and Q2.

Input Voltage Regulation in Charge Mode

In charge mode, if the input power source is not sufficient to support both the charge current and system load current, the input voltage will decrease. As the input voltage approaches the programmed input voltage regulation value, charge current is reduced to allow priority of system power and maintain the input voltage avoid dropping further.

The input voltage can be regulated by a resistor divider from IN pin to REG pin to AGND according to the following expression:

$$V_{\text{REG}} = V_{\text{IN_R}} \times \frac{R5}{R3 + R5} (\text{V}) \quad (4)$$

Where the V_{REG} is the internal voltage reference, 1.2V.

Setting the Charge Current

The external sense resistors, RS1 and R_{ISET} , program the battery charge current, I_{CHG} . Select R_{ISET} based on RS1:

$$I_{\text{CHG}} (\text{A}) = \frac{70(\text{k}\Omega)}{R_{\text{ISET}} (\text{k}\Omega)} \times \frac{40(\text{mV})}{\text{RS1}(\text{m}\Omega)} \quad (5)$$

Where the 40mV is the charge current limiting reference.

Battery Short Protection

The MP2635 has two current limit thresholds. CC and CV modes have a peak current limit threshold of 3.6A, while TC mode has a current limit threshold of 1.5A. Therefore, the current limit threshold decreases to 1.5A when the battery voltage drops below the TC threshold. Moreover, the switching frequency also decreases when the BATT voltage drops to 40% of the charge-full voltage.

Thermal Foldback Function

The MP2635 implements thermal protection to prevent thermal damage to the IC and the surrounding components. An internal thermal sense and feedback loop automatically decreases the programmed charge current when the die temperature reaches 120°C. This function is called the charge-current-thermal foldback. Not only does this function protect against thermal damage, it can also set the charge current based

on requirements rather than worst-case conditions while ensuring safe operation. Furthermore, the part includes thermal shutdown protection where the ceases charging if the junction temperature rises to 150°C.

Full-Operation Indication

The MP2635 integrates indicators for the following conditions as shown in Table2.

Table 2: Indicator for Each Operation Mode

| Operation | | ACOK | CHG | BOOST |
|------------------------|----------------------------------|------|----------|-------|
| Charge Mode | In Charging | Low | Low | High |
| | End of Charge, charging disabled | | High | |
| | NTC Fault, Timer Out | | Blinking | |
| Boost Mode | | High | High | Low |
| Sleep Mode, VCC absent | | High | High | High |

BOOST MODE OPERATION

Low-Voltage Start-Up

The minimum battery voltage required to start up the circuit in boost mode is 2.9V. Initially, when $V_{SYS} < V_{BATT}$, the MP2635 works in down mode. In this mode, the synchronous P-MOSFET stops switching and its gate connects to V_{BATT} statically. The P-MOSFET keeps off as long as the voltage across the parasitic C_{DS} (V_{SW}) is lower than V_{BATT} . When the voltage across C_{DS} exceeds V_{BATT} , the synchronous P-MOSFET enters a linear mode allowing the inductor current to decrease and flowing into the SYS pin. Once V_{SYS} exceeds V_{BATT} , the P-MOSFET gate is released and normal closed-loop PWM operation is initiated. In boost mode, the battery voltage can drop to as low as 2.5V without affecting circuit operation.

SYS Disconnect and Inrush Limiting

The MP2635 allows for true output disconnect by eliminating body diode conduction of the internal P-MOSFET rectifier. V_{SYS} can go to 0V during shutdown, drawing no current from the input source. It also allows for inrush current limiting at start-up, minimizing surge currents from the input supply. To optimize the benefits of output disconnect, avoid connecting an external Schottky diode between the SW and SYS pins. Board layout is extremely critical to minimize voltage overshoot at the SW pin due to stray inductance. Keep the output filter capacitor as close as possible to the SYS pin and use very low ESR/ESL ceramic capacitors tied to a good ground plane.

Boost Output Voltage

In the boost mode, the MP2635 programs the output voltage via the external resistor divider at FB pin, and provides built-in output over-voltage protection (OVP) to protect the device and other components against damage when V_{SYS} goes beyond 6V. Should output over-voltage occur, the MP2635 turns off the boost converter. Once V_{SYS} drops to a normal level, the boost converter restarts again as long as the MODE pin remains in active status.

Boost Output-Current Limiting

The MP2635 integrates a programmable output current limit function in boost mode. If the boost output current exceeds this programmable limit threshold, the output current will be limited at this level and the SYS voltage will start to drop down. The OLIM pin programs the current limit threshold up to 1.5A as per the following equation:

$$I_{OLIM}(A) = \frac{70(k\Omega) \times 40(mV) \times 1.6}{R_{OLIM}(k\Omega) \times RS1(m\Omega)} \quad (6)$$

Where the 40mV is the charge current limiting reference.

SYS Output Over-Current Protection

The MP2635 integrates three-phase output over-current protection.

Phase one (boost mode): when the output current exceeds the output current limit, the output constant current loop controls the output current, the output current remains at its limit of I_{OLIM} , and V_{SYS} decreases.

Phase two (down mode): when V_{SYS} drops below $V_{BATT}+100mV$ and the output current loop remains in control, the boost converter enters down mode and shutdown after a 120 μs blanking time.

Phase three (short circuit mode): when V_{SYS} drops below 2V, the boost converter shuts down immediately once the inductor current hits the fold-back peak current limit of the low side N-MOSFET. The boost converter can also recover automatically after a 1ms deglitch period.

Thermal Shutdown Protection

The thermal shutdown protection is also active in boost mode. Once the junction temperature rises higher than 150°C, the MP2635 enters thermal shutdown. It will not resume normal operation until the junction temperature drops below 120°C.

APPLICATION INFORMATION

COMPONENT SELECTION

Setting the Charge Current in Charge Mode

In charge mode, both the external sense resistor, RS1, and the resistor R_{ISET} connect to the ISET pin to set the charge current (I_{CHG}) of the MP2635 (see the Typical Application circuit).

Given I_{CHG} and RS1, the regulation threshold, V_{IREF}, across this resistor is:

$$V_{IREF} \text{ (mV)} = RS1 \text{ (m}\Omega) \times I_{CHG} \text{ (A)} \quad (7)$$

R_{ISET} sets V_{IREF} as per the following equation:

$$V_{IREF} \text{ (mV)} = \frac{70 \text{ (k}\Omega)}{R_{ISET} \text{ (k}\Omega)} \times 40 \text{ (mV)} \quad (8)$$

So, the R_{ISET} can be calculated as:

$$R_{ISET} \text{ (k}\Omega) = \frac{70 \text{ (k}\Omega)}{V_{IREF} \text{ (mV)}} \times 40 \text{ (mV)} \quad (9)$$

For example, for I_{CHG}=2A, and RS1=50mΩ, thus: V_{IREF}=100mV, so R_{ISET}=28kΩ.

Setting the Input Current Limiting in Charge Mode

In charge mode, connect a resistor from the ILIM pin to AGND to program the input current limit. The relationship between the input current limit and setting resistor is as following:

$$R_{ILIM} = \frac{40.5}{I_{IN_LIM} \text{ (A)}} \text{ (k}\Omega) \quad (10)$$

Where R_{ILIM} must exceed 15kΩ, so that I_{IN_LIM} is in the range of 0A to 2.7A.

For most applications, use R_{ILIM} = 45kΩ (I_{USB_LIM}=900mA) for USB3.0 mode, and use R_{ILIM} = 81kΩ (I_{USB_LIM}=500mA) for USB2.0 mode.

Setting the Input Voltage Range for Different Operation Modes

A resistive voltage divider from the input voltage to PWIN pin determines the operating mode of MP2635.

$$V_{PWIN} = V_{IN} \times \frac{R6}{R4 + R6} \text{ (V)} \quad (11)$$

If the voltage on PWIN is between 0.8V and 1.15V, the MP2635 works in the charge mode. While the voltage on the PWIN pin is not in the range of 0.8V to 1.15V and V_{IN} > 2V, the MP2635 works in the boost mode (see Table 1)).

For a wide operating range, use a maximum input voltage of 6V as the upper threshold for a voltage ratio of:

$$\frac{V_{PWIN}}{V_{IN}} = \frac{1.15}{6} = \frac{R6}{R4 + R6} \quad (12)$$

With the given R6, R4 is then:

$$R4 = \frac{V_{IN} - V_{PWIN}}{V_{PWIN}} \times R6 \quad (13)$$

For a typical application, start with R6=5.1kΩ, R4 is 21.5kΩ.

Setting the Input Voltage Regulation in Charge Mode

In charge mode, connect a resistor divider from the IN pin to AGND with tapped to REG pin to program the input voltage regulation.

$$V_{IN_R} = V_{REG} \times \frac{R3 + R5}{R5} \text{ (V)} \quad (14)$$

With the given R5, R3 is:

$$R3 = \frac{V_{IN_R} - V_{REG}}{V_{REG}} \times R5 \text{ (V)} \quad (15)$$

For a preset input voltage regulation value, say 4.75V, start with R5=5.1kΩ, R3 is 15kΩ.

NTC Function in Charge Mode

Figure 12 shows that an internal resistor divider sets the low temperature threshold (V_{TL}) and high temperature threshold (V_{TH}) at 66%·V_{SYS} and 35%·V_{SYS}, respectively. For a given NTC thermistor, select an appropriate R_{T1} and R_{T2} to set the NTC window.

$$\frac{V_{TL}}{V_{SYS}} = \frac{R_{T2} // R_{NTC_Cold}}{R_{T1} + R_{T2} // R_{NTC_Cold}} = TL = 66\% \quad (16)$$

$$\frac{V_{TH}}{V_{SYS}} = \frac{R_{T2} // R_{NTC_Hot}}{R_{T1} + R_{T2} // R_{NTC_Hot}} = TH = 35\% \quad (17)$$

Where R_{NTC_Hot} is the value of the NTC resistor at the upper bound of its operating temperature

range, and R_{NTC_Cold} is its lower bound.

The two resistors, R_{T1} and R_{T2} , independently determine the upper and lower temperature limits. This flexibility allows the MP2635 to operate with most NTC resistors for different temperature range requirements. Calculate R_{T1} and R_{T2} as follows:

$$R_{T1} = \frac{R_{NTC_Hot} \times R_{NTC_Cold} \times (TL - TH)}{TH \times TL \times (R_{NTC_Cold} - R_{NTC_Hot})} \quad (18)$$

$$R_{T2} = \frac{(TL - TH) \times R_{NTC_Cold} \times R_{NTC_Hot}}{(1 - TL) \times TH \times R_{NTC_Cold} - (1 - TH) \times TL \times R_{NTC_Hot}} \quad (19)$$

For example, the NCP18XH103 thermistor has the following electrical characteristic:

At 0°C, $R_{NTC_Cold} = 27.445k\Omega$;

At 50°C, $R_{NTC_Hot} = 4.1601k\Omega$.

Based on equation (18) and equation (19), $R_{T1}=6.58k\Omega$ and $R_{T2} = 23.89k\Omega$ are suitable for an NTC window between 0°C and 50°C. Chose approximate values: e.g., $R_{T1}=6.65k\Omega$ and $R_{T2}=23.7k\Omega$.

If no external NTC is available, connect R_{T1} and R_{T2} to keep the voltage on the NTC pin within the valid NTC window: e.g., $R_{T1} = R_{T2} = 10k\Omega$.

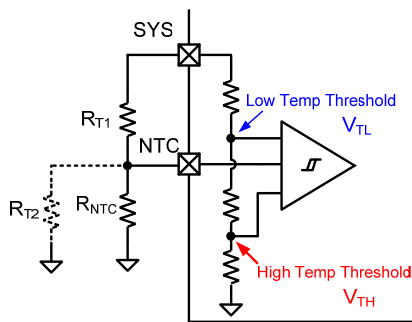

Figure 12: NTC Function Block

Setting the System Voltage in Boost Mode

In the boost mode, the system voltage can be regulated to the value customer required between 4.2V to 6V by the resistor divider at FB pin as R1 and R2 in the typical application circuit.

$$V_{SYS} = 1.2V \times \frac{R1 + R2}{R2} \quad (20)$$

Where 1.2V is the voltage reference of SYS. With a typical value for R2, 10kΩ, R1 can be determined by:

$$R1 = R2 \times \frac{V_{SYS} - 1.2V}{1.2V} \quad (21)$$

For example, for a 5V system voltage, R2 is 10kΩ, and R1 is 31.6kΩ.

Setting the Output Current Limit in Boost Mode

In boost mode, connect a resistor from the OLIM pin to AGND to program the output current limit. The relationship between the output current limit and setting resistor is as follows:

$$R_{OLIM}(k\Omega) = \frac{70(k\Omega) \times 40(mV) \times 1.6}{I_{OLIM}(A) \times RS1(m\Omega)} \quad (22)$$

Where R_{OLIM} is supposed to be greater than 59kΩ with $RS1=50m\Omega$, so that I_{OLIM} can be programmed up to 1.5A.

Selecting the Inductor

Inductor selection trades off between cost, size, and efficiency. A lower inductance value corresponds with smaller size, but results in higher ripple currents, higher magnetic hysteretic losses, and higher output capacitances. However, a higher inductance value benefits from lower ripple current and smaller output filter capacitors, but results in higher inductor DC resistance (DCR) loss.

Choose an inductor that does not saturate under the worst-case load condition.

1. In Charge Mode

When MP2635 works in charge mode (as a Buck Converter), estimate the required inductance as:

$$L = \frac{V_{IN} - V_{BATT}}{\Delta I_{L_MAX}} \times \frac{V_{BATT}}{V_{IN} \times f_S} \quad (23)$$

Where V_{IN} , V_{BATT} , and f_S are the typical input voltage, the CC charge threshold, and the switching frequency, respectively. ΔI_{L_MAX} is the maximum inductor ripple current, which is usually designed at 30% of the CC charge current.

With a typical 5V input voltage, 30% inductor current ripple at the corner point between trickle charge and CC charge ($V_{BATT}=3V$), the inductance is 1.67μH (for a 1.2MHz switching frequency) and 3.33μH (for a 600kHz switching frequency).

2. In Boost Mode

When the MP2635 is in Boost mode (as a Boost converter), the required inductance value is calculated as:

$$L = \frac{V_{BATT} \times (V_{SYS} - V_{BATT})}{V_{SYS} \times f_s \times \Delta I_{L_MAX}} \quad (24)$$

$$\Delta I_{L_MAX} = (30\% - 40\%) \times I_{BATT(MAX)} \quad (25)$$

$$I_{BATT(MAX)} = \frac{V_{SYS} \times I_{SYS}}{V_{BATT} \times \eta} \quad (26)$$

Where V_{BATT} is the minimum battery voltage, f_{SW} is the switching frequency, and ΔI_{L_MAX} is the peak-to-peak inductor ripple current, which is approximately 30% of the maximum battery current $I_{BATT(MAX)}$, $I_{SYS(MAX)}$ is the system current and η is the efficiency.

In the worst case where the battery voltage is 3V, a 30% inductor current ripple, and a typical system voltage ($V_{SYS}=5V$), the inductance is 1.8 μ H (for the 1.2MHz switching frequency) and 3.6 μ H (for the 600kHz switching frequency) when the efficiency is 90%.

For best results, use an inductor with an inductance of 1.8 μ H (for the 1.2MHz switching frequency) and 3.6 μ H (for the 600kHz switching frequency) with a DC current rating that is at least 30% higher than the maximum charge current for applications. For higher efficiency, minimize the inductor's DC resistance.

Selecting the Input Capacitor C_{IN}

The input capacitor C_{IN} reduces both the surge current drawn from the input and the switching noise from the device. The input capacitor impedance at the switching frequency should be less than the input source impedance to prevent high-frequency-switching current from passing to the input. For best results, use ceramic capacitors with X5R or X7R dielectrics because of their low ESR and small temperature coefficients. For most applications, a 22 μ F capacitor will suffice.

Selecting the System Capacitor C_{SYS}

Select C_{SYS} based on the demand of the system current ripple.

1. Charge Mode

The capacitor C_{SYS} acts as the input capacitor of the buck converter in charge mode. The input current ripple is:

$$I_{RMS_MAX} = I_{SYS_MAX} \times \frac{\sqrt{V_{TC} \times (V_{IN_MAX} - V_{TC})}}{V_{IN_MAX}} \quad (27)$$

2. Boost Mode

The capacitor, C_{SYS} , is the output capacitor of boost converter. C_{SYS} keeps the system voltage ripple small and ensures feedback loop stability. The system current ripple is given by:

$$I_{RMS_MAX} = I_{SYS_MAX} \times \frac{\sqrt{V_{TC} \times (V_{SYS_MAX} - V_{TC})}}{V_{SYS_MAX}} \quad (28)$$

Since the input voltage is passes to the system directly, $V_{IN_MAX}=V_{SYS_MAX}$, both charge mode and boost mode have the same system current ripple.

For $I_{CC_MAX}=2A$, $V_{TC}=3V$, $V_{IN_MAX}=6V$, the maximum ripple current is 1A. Select the system capacitors base on the ripple-current temperature rise not exceeding 10°C. For best results, use ceramic capacitors with X5R or X7R dielectrics with low ESR and small temperature coefficients. For most applications, use a 22 μ F capacitor.

Selecting the Battery Capacitor C_{BATT}

C_{BATT} is in parallel with the battery to absorb the high-frequency switching ripple current.

1. Charge Mode

The capacitor C_{BATT} is the output capacitor of the buck converter. The output voltage ripple is then:

$$\Delta r_{BATT} = \frac{\Delta V_{BATT}}{V_{BATT}} = \frac{1 - V_{BATT} / V_{SYS}}{8 \times C_{BATT} \times f_s^2 \times L} \quad (29)$$

2. Boost Mode

The capacitor C_{BATT} is the input capacitor of the boost converter. The input voltage ripple is the same as the output voltage ripple from equation (29)

Both charge mode and boost mode have the same battery voltage ripple. The capacitor C_{BATT} can be calculated as:

$$C_{BATT} = \frac{1 - V_{TC} / V_{SYS_MAX}}{8 \times \Delta r_{BATT_MAX} \times f_S^2 \times L} \quad (30)$$

To guarantee the $\pm 0.5\%$ BATT voltage accuracy, the maximum BATT voltage ripple must not exceed 0.5% (e.g. 0.1%). The worst case occurs at the minimum battery voltage of the CC charge with the maximum input voltage.

For $V_{SYS_MAX}=6V$, $V_{CC_MIN}=V_{TC}=3V$, $L=3.9\mu H$, $f_S=600kHz$ or $1.2MHz$, $\Delta r_{BATT_MAX} = 0.1\%$, C_{BATT} is $22\mu F$ (for a 600kHz switching frequency) or $10\mu F$ (for a 1.2MHz switching frequency).

A $22\mu F$ ceramic with X5R or X7R dielectrics capacitor will be OK.

PCB Layout Guide

PCB layout is very important to meet specified noise, efficiency and stability requirements. The following design considerations can improve circuit performance:

1) Route the power stage adjacent to their grounds. Aim to minimize the high-side switching node (SW, inductor) trace lengths in the high-current paths and the current sense resistor trace.

Keep the switching node short and away from all small control signals, especially the feedback network.

Place the input capacitor as close as possible to the VIN and PGND pins. The local power input capacitors, connected from the SYS to PGND, must be placed as close as possible to the IC.

Place the output inductor close to the IC and connect the output capacitor between the inductor and PGND of the IC.

2) For high-current applications, the power pads for IN, SYS, SW, BATT and PGND should be connected to as many coppers planes on the

board as possible. The exposed pad should connect to as many GND copper planes in the board as possible. This improves thermal performance because the board conducts heat away from the IC.

3) The PCB should have a ground plane connected directly to the return of all components through vias (e.g., two vias per capacitor for power-stage capacitors, one via per capacitor for small-signal components). If possible, add vias inside the exposed pads for the IC. A star ground design approach is typically used to keep circuit block currents isolated (power-signal/control-signal), which reduces noise-coupling and ground-bounce issues. A single ground plane for this design gives good results.

4) Place ISET, OLIM and ILIM resistors very close to their respective IC pins.

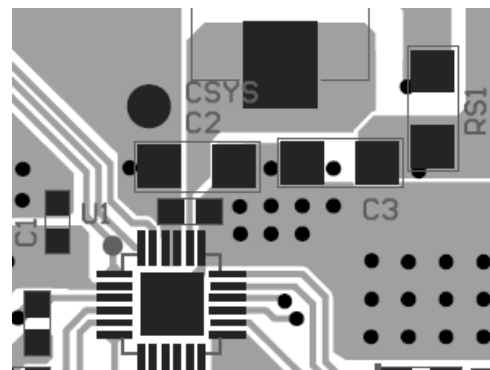

Top Layer

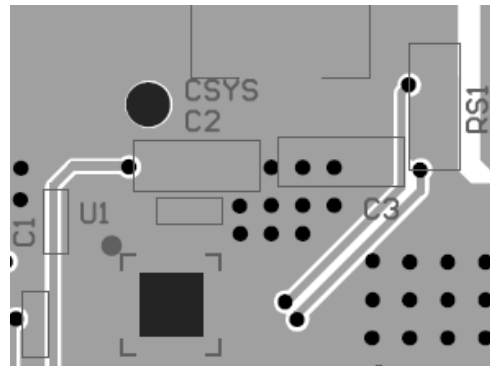

Bottom Layer

Figure 13: PCB Layout Guide

Design Example

Below is a design example following the application guidelines for the specifications:

Table 3: Design Example

| | |
|-----------|---------|
| V_{IN} | 5V |
| V_{OUT} | 3.7V |
| f_{SW} | 1200kHz |

Figure 14 shows the detailed application schematic. The Typical Performance Characteristics section shows the typical performance and circuit waveforms. For more possible applications of this device, please refer to the related Evaluation Board datasheets.

TYPICAL APPLICATION CIRCUITS

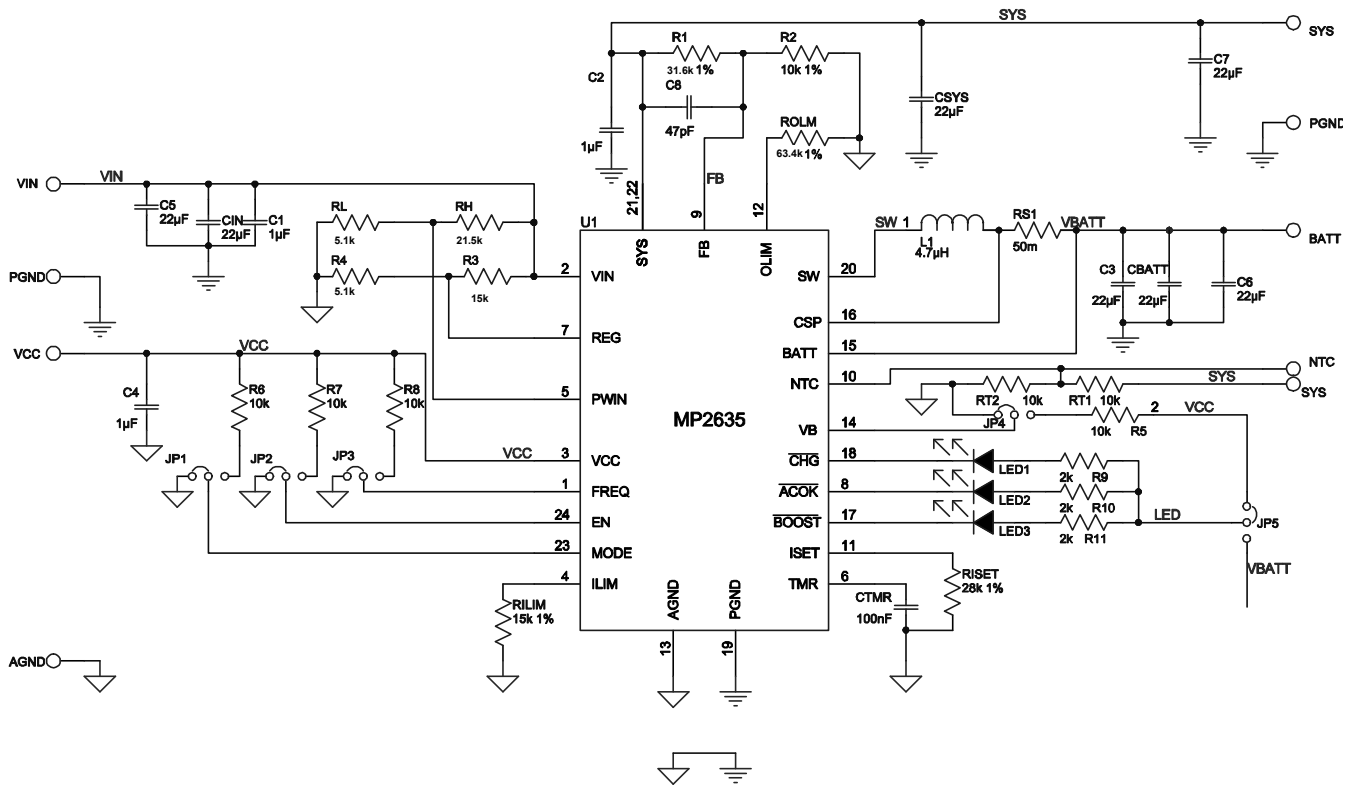
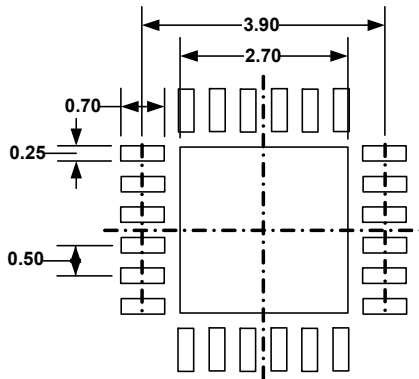
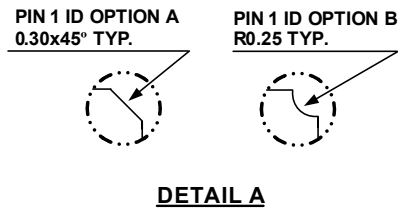
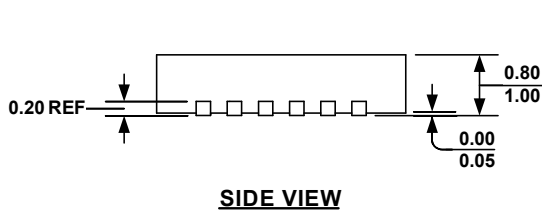
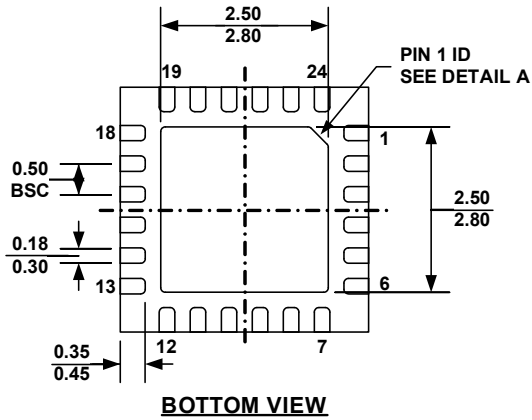
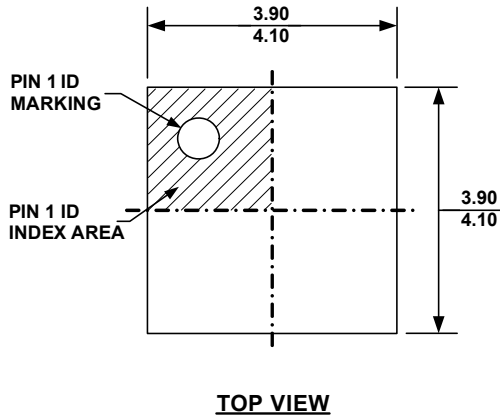

Figure 14: The detailed application circuit of MP2635

PACKAGE INFORMATION

QFN24 (4x4mm)



NOTE:

- 1) ALL DIMENSIONS ARE IN MILLIMETERS
- 2) EXPOSED PADDLE SIZE DOES NOT INCLUDE MOLD FLASH
- 3) LEAD COPLANARITY SHALL BE 0.10 MILLIMETER MAX
- 4) DRAWING CONFIRMS TO JEDEC MO220, VARIATION VGGD.
- 5) DRAWING IS NOT TO SCALE

NOTICE: The information in this document is subject to change without notice. Users should warrant and guarantee that third party Intellectual Property rights are not infringed upon when integrating MPS products into any application. MPS will not assume any legal responsibility for any said applications.