

## ATA 8W Series

### 8 Watts DC/DC Converter

**Total Power:** 8 Watts  
**Input Voltage:** 9 to 36Vdc  
18 to 75Vdc  
**# of Outputs:** Single, dual



### Special Features

- Smallest Encapsulated 8W Converter
- Industrial Standard DIP-16 Package
- Ultra-wide 4:1 Input Voltage Range
- Fully Regulated Output Voltage
- I/O Isolation 1500Vdc
- Operating Ambient Temp. Range -40 °C to +80°C (With derating)
- Low No Load Power Consumption
- No Minimum Load Requirement
- Overload and Short Circuit Protection
- Shielded Metal Case with Insulated Baseplate
- Designed-in Conducted EMI meets EN55032/22 Class A & FCC Level A

### Safety

UL/cUL/IEC/EN 60950-1  
CE Mark

## Product Descriptions

The ATA 8W series is the latest generation of high performance DC-DC converter modules setting a new standard concerning power density. The product offers a full 8W isolated DC-DC converter within an encapsulated DIP-16 package which occupies only 0.5 in<sup>2</sup> of PCB space. There are 14 models available for 24, 48Vdc with ultra-wide 4:1 input voltage range. Further features include overload protection, short circuit protection, low no load power consumption and no minimum load requirement as well. An high efficiency allows operating temperatures range of -40 °C to +80°C.

These converters offer an economical solution for many cost critical applications in battery-powered equipment, instrumentation, distributed power architectures in communication, industrial electronics, energy facilities and many other critical applications where PCB space is limited.

## Model Numbers

Model	Input Voltage	Output Voltage	Maximum Load	Efficiency
ATA02F18-L	9-36Vdc	3.3Vdc	2A	78%
ATA02A18-L	9-36Vdc	5Vdc	1.6A	82%
ATA02B18-L	9-36Vdc	12Vdc	0.665A	85%
ATA02C18-L	9-36Vdc	15Vdc	0.535A	85%
ATA02H18-L	9-36Vdc	24Vdc	0.335A	86%
ATA02BB18-L	9-36Vdc	±12Vdc	±0.335A	85%
ATA02CC18-L	9-36Vdc	±15Vdc	±0.265A	86%
ATA02F36-L	18-75Vdc	3.3Vdc	2A	78%
ATA02A36-L	18-75Vdc	5Vdc	1.6A	81%
ATA02B36-L	18-75Vdc	12Vdc	0.665A	85%
ATA02C36-L	18-75Vdc	15Vdc	0.535A	85%
ATA02H36-L	18-75Vdc	24Vdc	0.335A	86%
ATA02BB36-L	18-75Vdc	±12Vdc	±0.335A	86%
ATA02CC36-L	18-75Vdc	±15Vdc	±0.265A	86%

## Options

None

## Electrical Specifications

### Absolute Maximum Ratings

Stress in excess of those listed in the “Absolute Maximum Ratings” may cause permanent damage to the power supply. These are stress ratings only and functional operation of the unit is not implied at these or any other conditions above those given in the operational sections of this TRN. Exposure to any absolute maximum rated condition for extended periods may adversely affect the power supply’s reliability.

Table 1. Absolute Maximum Ratings:

Parameter	Model	Symbol	Min	Typ	Max	Unit
Input Surge Voltage 1 Sec.max	24V Input Models 48V Input Models	$V_{IN,DC}$	-0.7 -0.7	- -	50 100	Vdc Vdc
Maximum Output Power	All models	$P_{O,max}$	-	-	8	W
Isolation Voltage Input to output (60 seconds) (1 seconds)	All models All models		1500 1800	- -	- -	Vdc Vdc
Isolation Resistance	All models		1000	-	-	Mohm
Isolation Capacitance	All models		-	500	-	pF
Operating Ambient Temperature Range	All models		-40		+80 <sup>1</sup>	°C
Operating Case Temperature	All models	$T_{CASE}$	-	-	+105	°C
Storage Temperature	All models	$T_{STG}$	-50		+125	°C
Humidity (non-condensing) Operating Non-operating	All models All models		- -	- -	95 95	% %
MTBF (MIL-HDBK-217F@25°C, Ground Benign)	All models		2358263	-	-	Hours

Note 1 - With Derating and under Natural Convection

## Input Specifications

Table 2. Input Specifications:

Parameter		Condition	Symbol	Min	Typ	Max	Unit
Operating Input Voltage, DC	24V Input Models 48V Input Models	All	$V_{IN,DC}$	9 18	24 48	36 75	Vdc Vdc
Start-Up Threshold Voltage	24V Input Models 48V Input Models	All	$V_{IN,ON}$	- -	9 18	- -	Vdc Vdc
Under Voltage Shutdown	24V Input Models 48V Input Models	All	$V_{IN,OFF}$	- -	8 16	- -	Vdc Vdc
Input Current	ATA02F18-L ATA02A18-L ATA02B18-L ATA02C18-L ATA02H18-L ATA02BB18-L ATA02CC18-L ATA02F36-L ATA02A36-L ATA02B36-L ATA02C36-L ATA02H36-L ATA02BB36-L ATA02CC36-L	$V_{IN,DC}=V_{IN,nom}$	$I_{IN,full\ load}$	- - - - - - - - - - - - - -	353 407 391 393 390 394 385 176 206 196 197 195 195 193	- - - - - - - - - - - - - -	mA mA mA mA mA mA mA mA mA mA mA mA mA mA
No Load Input Current ( $V_O$ On, $I_O = 0A$ )	24V Input Models 48V Input Models	$V_{IN,DC}=V_{IN,nom}$	$I_{IN,no\_load}$	- -	10 8	- -	mA mA
Efficiency @Max. Load	ATA02F18-L ATA02A18-L ATA02B18-L ATA02C18-L ATA02H18-L ATA02BB18-L ATA02CC18-L ATA02F36-L ATA02A36-L ATA02B36-L ATA02C36-L ATA02H36-L ATA02BB36-L ATA02CC36-L	$V_{IN,DC}=V_{IN,nom}$ $I_O=I_{O,max}$ $T_A=25\ ^\circ C$	$\eta$	- - - - - - - - - - - - - -	78 82 85 85 86 85 86 78 81 85 85 86 86 86	- - - - - - - - - - - - - -	% % % % % % % % % % % % % %
Input Filter		All		Internal Pi Type			

## Output Specifications

Table 3: Output Specifications

Parameter		Condition	Symbol	Min	Typ	Max	Unit
Output Voltage Set -Point		$V_{IN,DC} = V_{IN,nom}$ $I_O = I_{O,max}$ $T_A = 25\text{ }^\circ\text{C}$	$\pm V_O$	-	-	2	%
Output Current	ATA02F18-L	Convection Cooling	$I_O$	-	-	2	A
	ATA02A18-L			-	-	1.6	A
	ATA02B18-L			-	-	0.665	A
	ATA02C18-L			-	-	0.535	A
	ATA02H18-L			-	-	0.335	A
	ATA02BB18-L			-	-	$\pm 0.335$	A
	ATA02CC18-L			-	-	$\pm 0.265$	A
	ATA02F36-L			-	-	2	A
	ATA02A36-L			-	-	1.6	A
	ATA02B36-L			-	-	0.665	A
	ATA02C36-L			-	-	0.535	A
	ATA02H36-L			-	-	0.335	A
	ATA02BB36-L			-	-	$\pm 0.335$	A
	ATA02CC36-L			-	-	$\pm 0.265$	A
Load Capacitance	ATA02F18-L	All	$C_O$	-	-	680	$\mu\text{F}$
	ATA02A18-L			-	-	680	$\mu\text{F}$
	ATA02B18-L			-	-	330	$\mu\text{F}$
	ATA02C18-L			-	-	330	$\mu\text{F}$
	ATA02H18-L			-	-	150	$\mu\text{F}$
	ATA02BB18-L			-	-	150	$\mu\text{F}$
	ATA02CC18-L			-	-	150	$\mu\text{F}$
	ATA02F36-L			-	-	680	$\mu\text{F}$
	ATA02A36-L			-	-	680	$\mu\text{F}$
	ATA02B36-L			-	-	330	$\mu\text{F}$
	ATA02C36-L			-	-	330	$\mu\text{F}$
	ATA02H36-L			-	-	150	$\mu\text{F}$
	ATA02BB36-L			-	-	150	$\mu\text{F}$
	ATA02CC36-L			-	-	150	$\mu\text{F}$
Line Regulation		$V_{IN,DC} = V_{IN,min}$ to $V_{IN,max}$	$\pm\%V_O$	-	0.2	0.8	%
Load Regulation		$I_O = I_{O,min}$ to $I_{O,max}$	$\pm\%V_O$	-	0.5	1.0	%
Switching Frequency		All	$f_{SW}$	-	370	-	KHz
Temperature Coefficient		All	$\pm\%/^\circ\text{C}$	-	0.01	0.02	%
Output Over Current Protection <sup>1</sup>		All	$\%I_{O,max}$	-	150	-	%
Output Short Circuit Protection		All		Hiccup Mode 0.3Hz type, Automatic Recovery			

Note 1 – Hiccup mode.

## Output Specifications

Table 3: Output Specifications con't

Parameter	Condition	Symbol	Min	Typ	Max	Unit
Output Ripple, pk-pk	Measure with a 4.7uF ceramic capacitor in parallel with a 10uF tantalum capacitor, 0 to 20MHz bandwidth	$V_O$	-	-	55	mV
$V_O$ Dynamic Response Peak Deviation Recovery Time	25% load change	$\pm\%V_O$ $\pm\%V_{SB}$	- -	3 -	5 500	% uSec

## ATA02F18-L Performance Curves

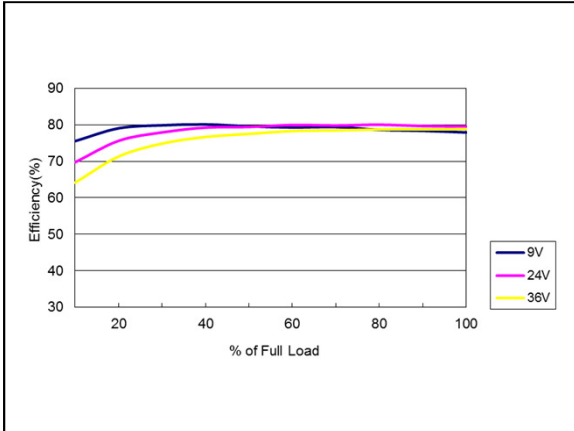

Figure 1: ATA02F18-L Efficiency Versus Output Current Curve  
Vin = 9 to 36Vdc Load: Io = 0 to 2A

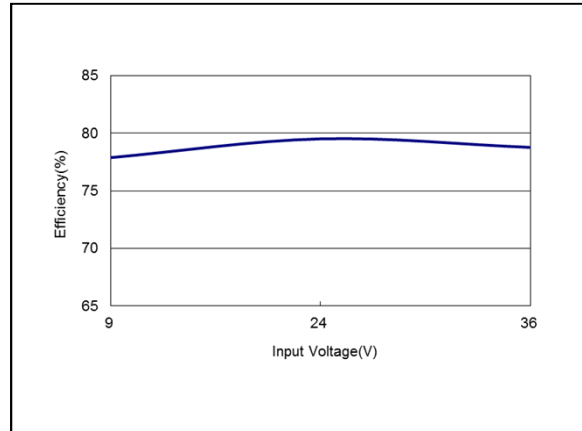

Figure 2: ATA02F18-L Efficiency Versus Input Voltage Curve  
Vin = 9 to 36Vdc Load: Io = 2A

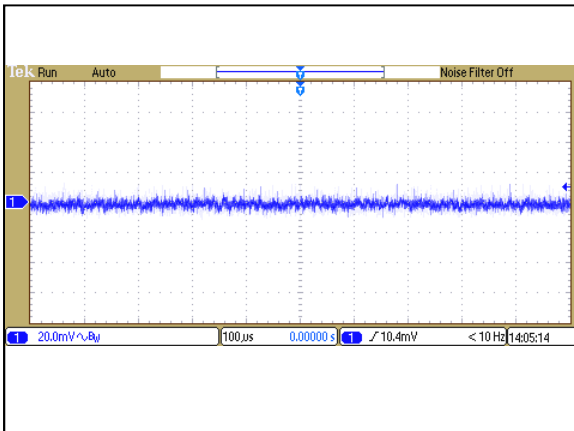

Figure 3: ATA02F18-L Ripple and Noise Measurement  
Vin = 24Vdc Load: Io = 2A  
Ch 1: Vo

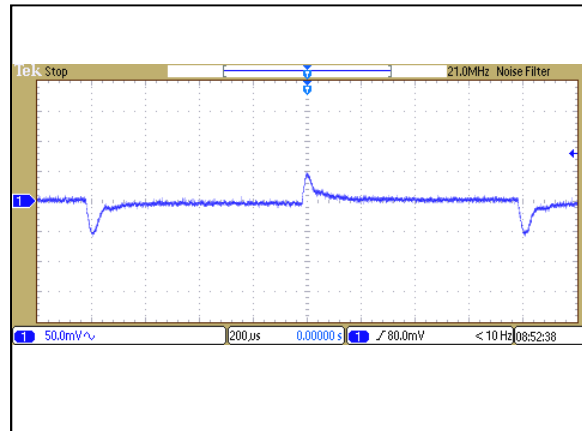

Figure 4: ATA02F18-L Transient Response  
Vin = 24Vdc Load: Io = 100% to 75% load change  
Ch 1: Vo

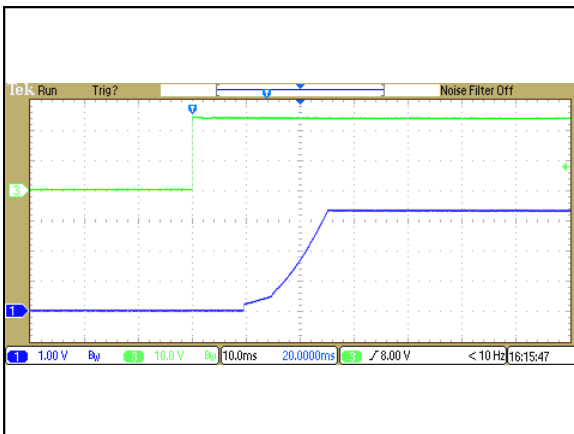

Figure 5: ATA02F18-L Output Voltage Startup Characteristic by Vin  
Vin = 24Vdc Load: Io = 2A  
Ch1: Vo Ch3: Vin

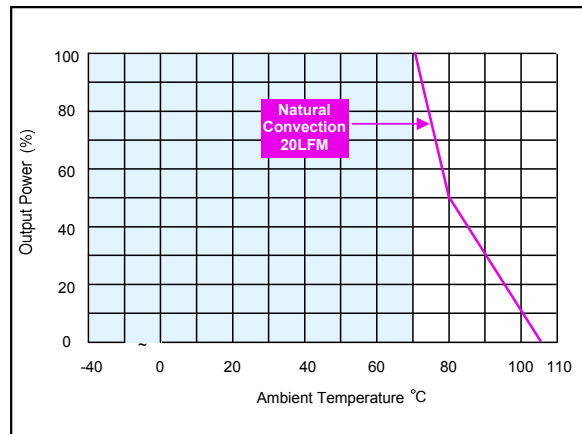

Figure 6: ATA02F18-L Derating Output Current vs Ambient Temperature  
Vin = 24Vdc Load: Io = 2A

## ATA02A18-L Performance Curves

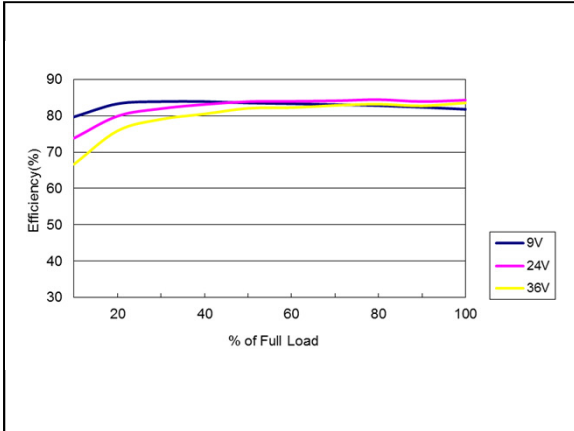

Figure 7: ATA02A18-L Efficiency Versus Output Current Curve  
Vin = 9 to 36Vdc Load: Io = 0 to 1.6A

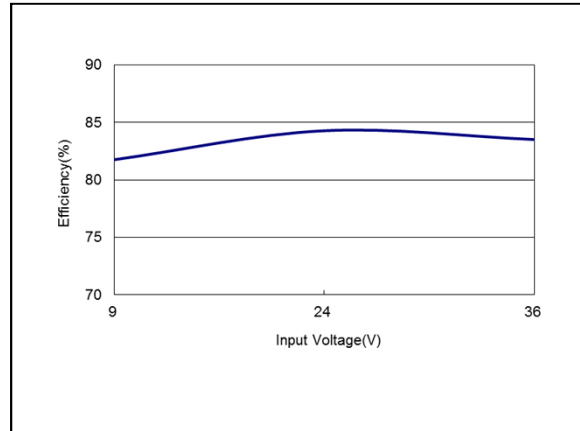

Figure 8: ATA02A18-L Efficiency Versus Input Voltage Curve  
Vin = 9 to 36Vdc Load: Io = 1.6A

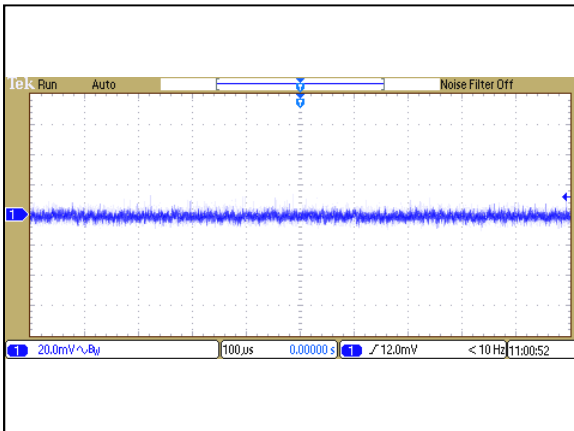

Figure 9: ATA02A18-L Ripple and Noise Measurement  
Vin = 24Vdc Load: Io = 1.6A  
Ch 1: Vo

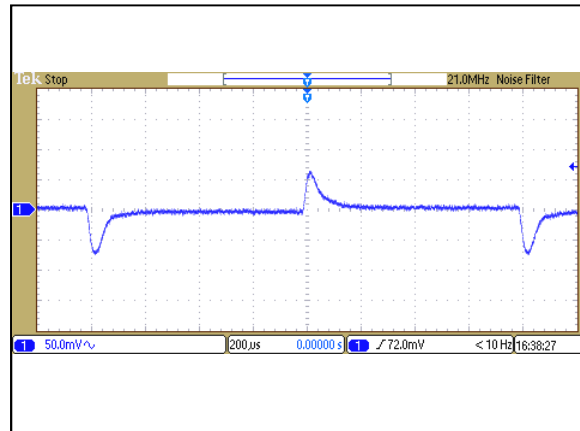

Figure 10: ATA02A18-L Transient Response  
Vin = 24Vdc Load: Io = 100% to 75% load change  
Ch 1: Vo

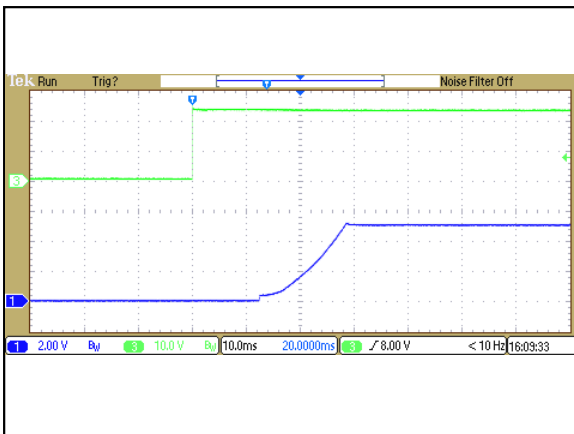

Figure 11: ATA02A18-L Output Voltage Startup Characteristic by Vin  
Vin = 24Vdc Load: Io = 1.6A  
Ch1: Vo Ch3: Vin

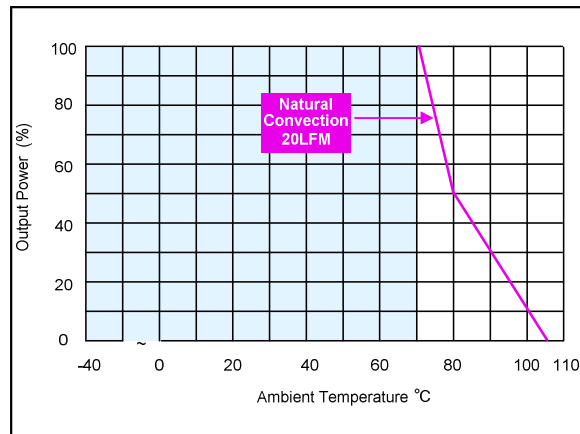

Figure 12: ATA02A18-L Derating Output Current vs Ambient Temperature  
Vin = 24Vdc Load: Io = 1.6A



## ATA02B18-L Performance Curves

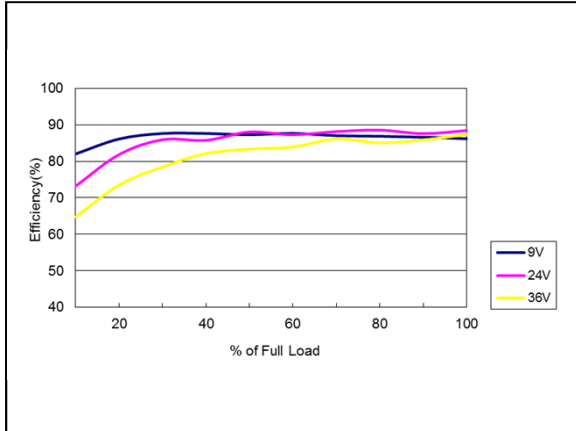

Figure 13: ATA02B18-L Efficiency Versus Output Current Curve  
Vin = 9 to 36Vdc Load: Io = 0 to 0.665A

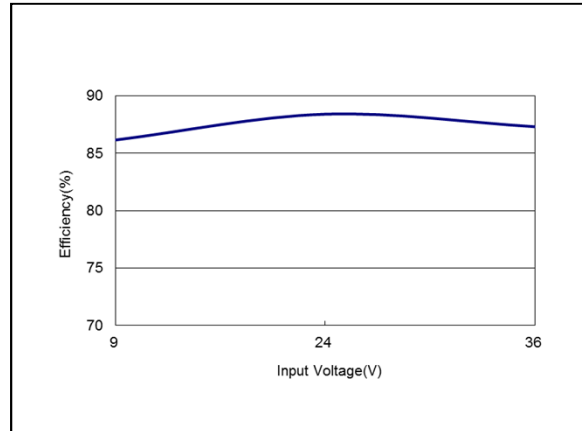

Figure 14: ATA02B18-L Efficiency Versus Input Voltage Curve  
Vin = 9 to 36Vdc Load: Io = 0.665A

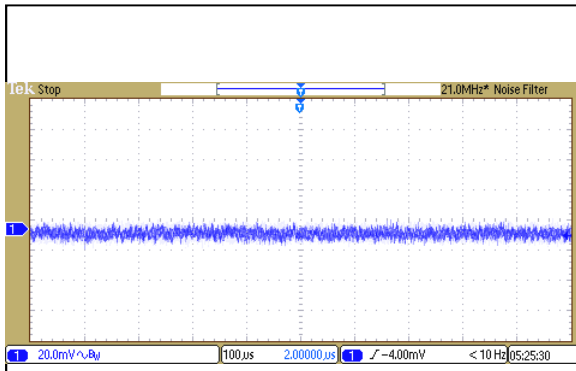

Figure 15: ATA02B18-L Ripple and Noise Measurement  
Vin = 24Vdc Load: Io = 0.665A  
Ch 1: Vo

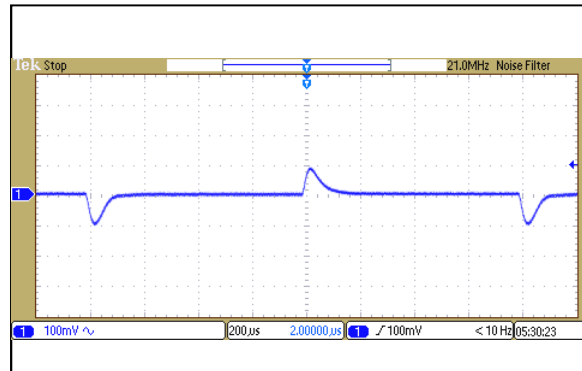

Figure 16: ATA02B18-L Transient Response  
Vin = 24Vdc Load: Io = 100% to 75% load change  
Ch 1: Vo

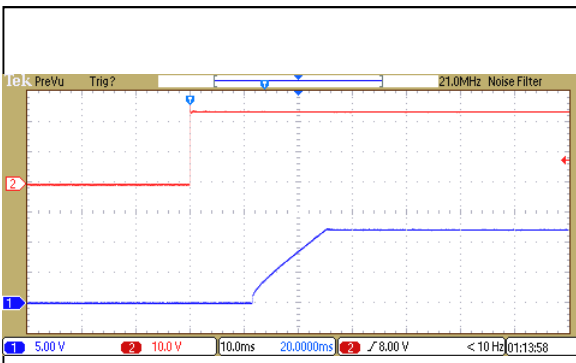

Figure 17: ATA02B18-L Output Voltage Startup Characteristic by Vin  
Vin = 24Vdc Load: Io = 0.665A  
Ch1: Vo Ch3: Vin

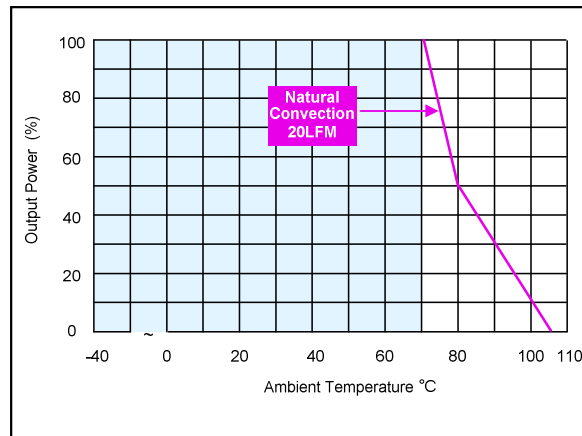

Figure 18: ATA02B18-L Derating Output Current vs Ambient Temperature  
Vin = 24Vdc Load: Io = 0.665A

## ATA02C18-L Performance Curves

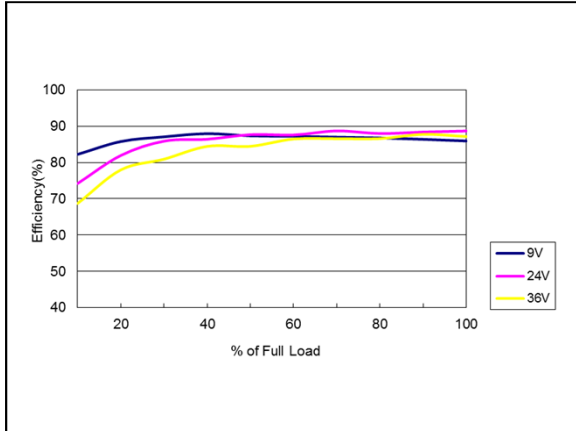

Figure 19: ATA02C18-L Efficiency Versus Output Current Curve  
Vin = 9 to 36Vdc Load: Io = 0 to 0.535A

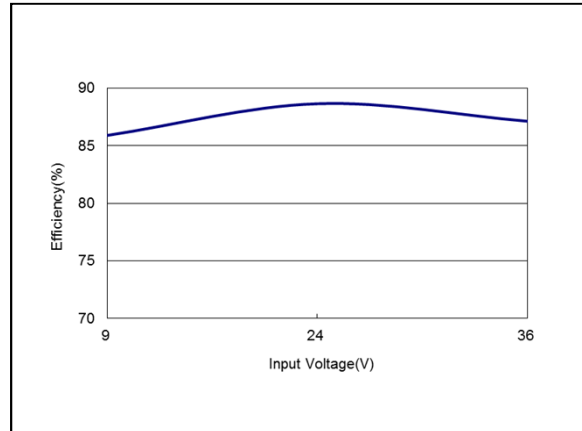

Figure 20: ATA02C18-L Efficiency Versus Input Voltage Curve  
Vin = 9 to 36Vdc Load: Io = 0.535A

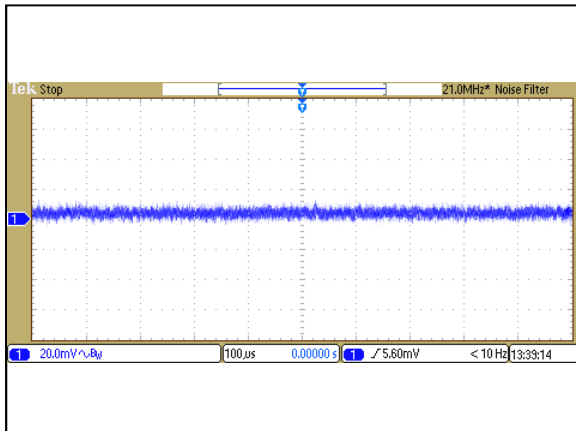

Figure 21: ATA02C18-L Ripple and Noise Measurement  
Vin = 24Vdc Load: Io = 0.535A  
Ch 1: Vo

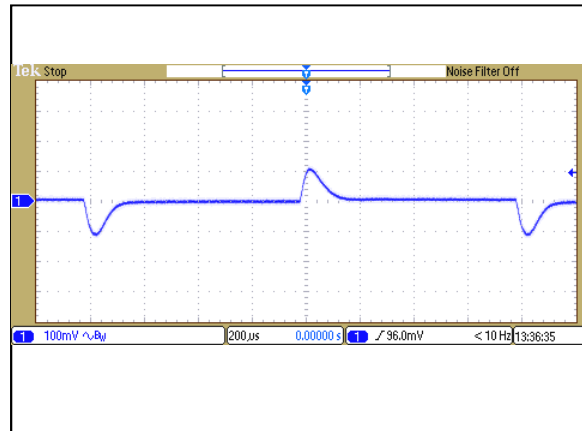

Figure 22: ATA02C18-L Transient Response  
Vin = 24Vdc Load: Io = 100% to 75% load change  
Ch 1: Vo

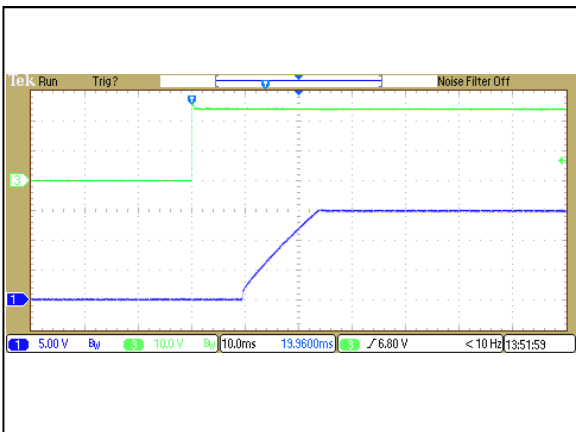

Figure 23: ATA02C18-L Output Voltage Startup Characteristic by Vin  
Vin = 24Vdc Load: Io = 0.535A  
Ch1: Vo Ch3: Vin

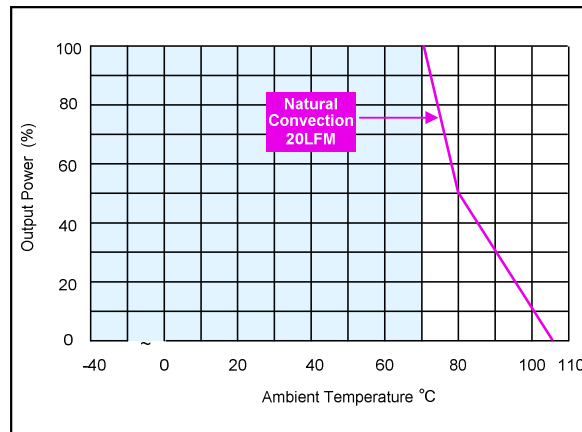

Figure 24: ATA02C18-L Derating Output Current vs Ambient Temperature  
Vin = 24Vdc Load: Io = 0.535A

## ATA02H18-L Performance Curves

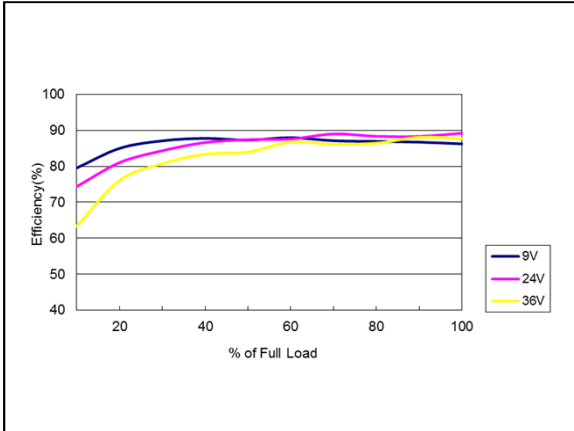

Figure 25: ATA02H18-L Efficiency Versus Output Current Curve  
Vin = 9 to 36Vdc Load: Io = 0 to 0.335A

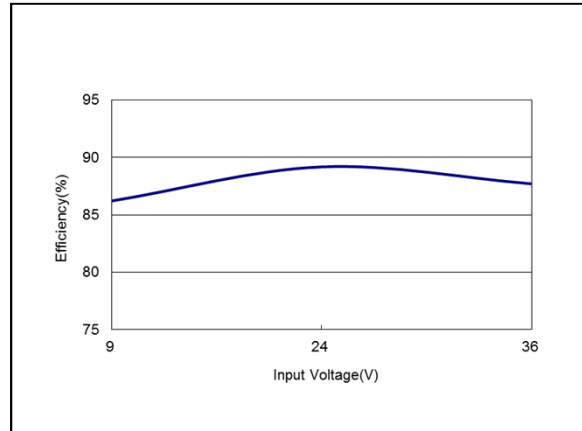

Figure 26: ATA02H18-L Efficiency Versus Input Voltage Curve  
Vin = 9 to 36Vdc Load: Io = 0.335A

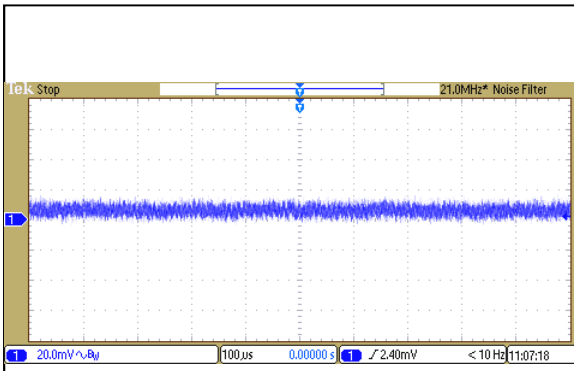

Figure 27: ATA02H18-L Ripple and Noise Measurement  
Vin = 24Vdc Load: Io = 0.335A  
Ch 1: Vo

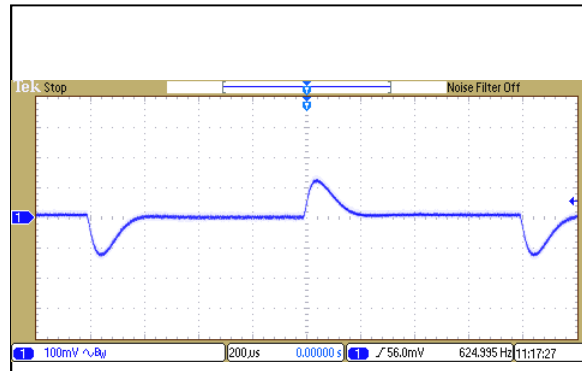

Figure 28: ATA02H18-L Transient Response  
Vin = 24Vdc Load: Io = 100% to 75% load change  
Ch 1: Vo

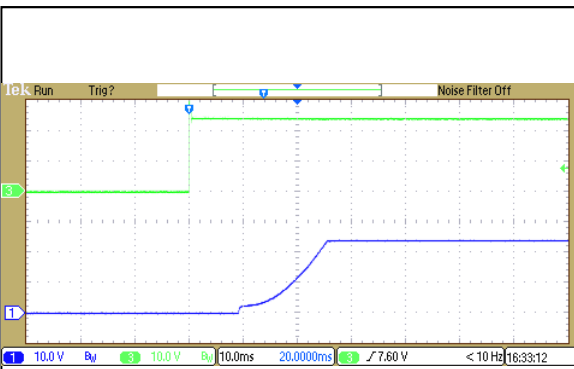

Figure 29: ATA02H18-L Output Voltage Startup Characteristic by Vin  
Vin = 24Vdc Load: Io = 0.335A  
Ch1: Vo Ch3: Vin

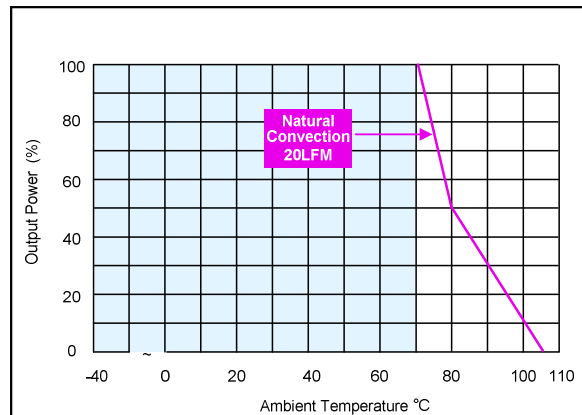

Figure 30: ATA02H18-L Derating Output Current vs Ambient Temperature  
Vin = 24Vdc Load: Io = 0.335A

## ATA02BB18-L Performance Curves

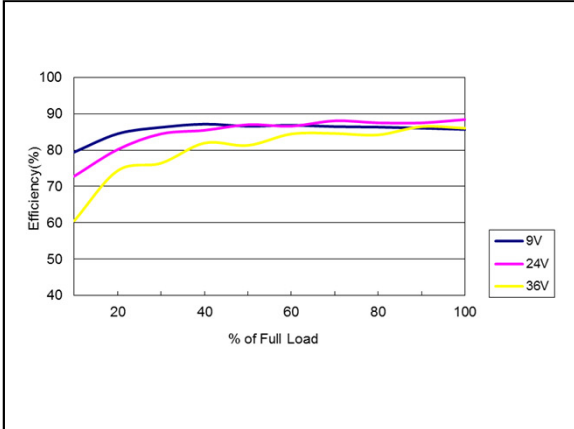

Figure 31: ATA02BB18-L Efficiency Versus Output Current Curve  
Vin = 9 to 36Vdc Load: Io = 0 to ±0.335A

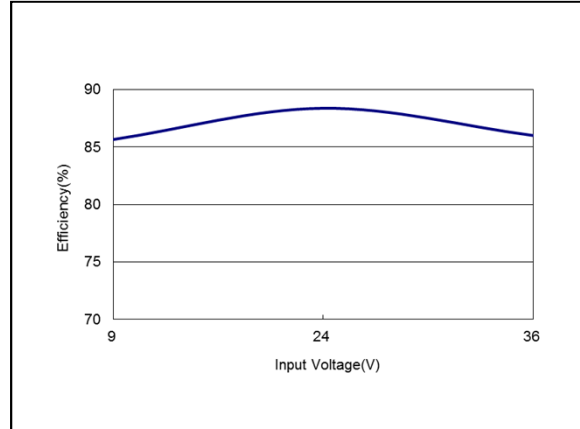

Figure 32: ATA02BB18-L Efficiency Versus Input Voltage Curve  
Vin = 9 to 36Vdc Load: Io = ±0.335A

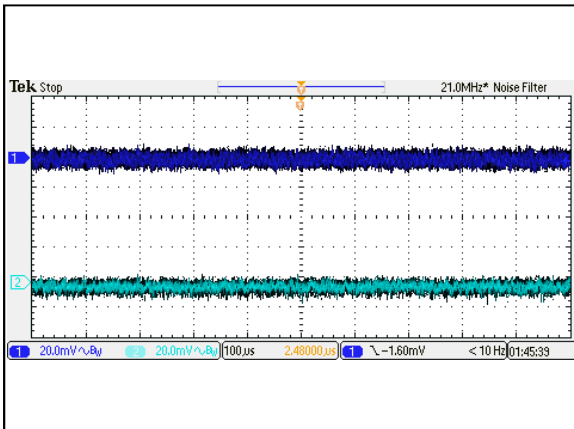

Figure 33: ATA02BB18-L Ripple and Noise Measurement  
Vin = 24Vdc Load: Io = ±0.335A  
Ch 1: Vo1 Ch 2: Vo2

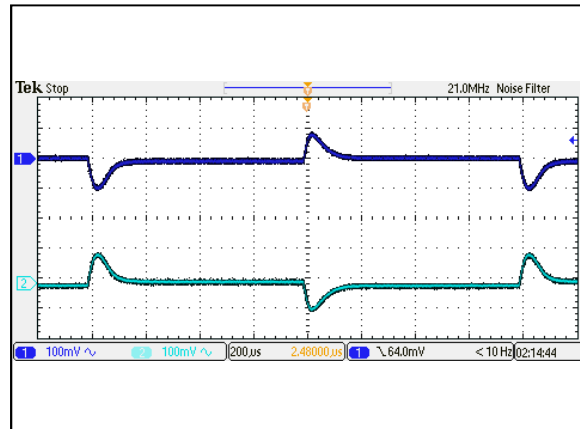

Figure 34: ATA02BB18-L Transient Response  
Vin = 24Vdc Load: Io = 100% to 75% load change  
Ch 1: Vo1 Ch 2: Vo2

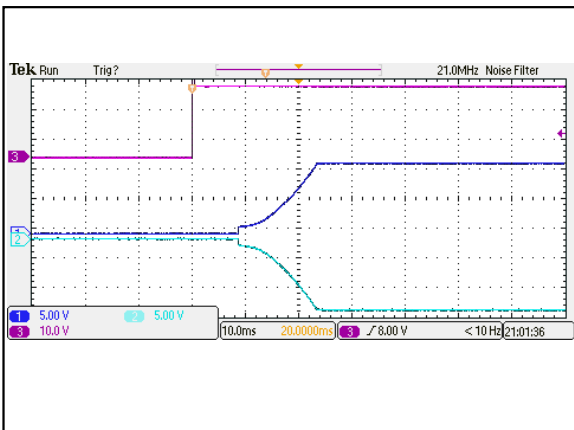

Figure 35: ATA02BB18-L Output Voltage Startup Characteristic by Vin  
Vin = 24Vdc Load: Io = ±0.335A  
Ch1: Vo1 Ch2:Vo2 Ch3: Vin

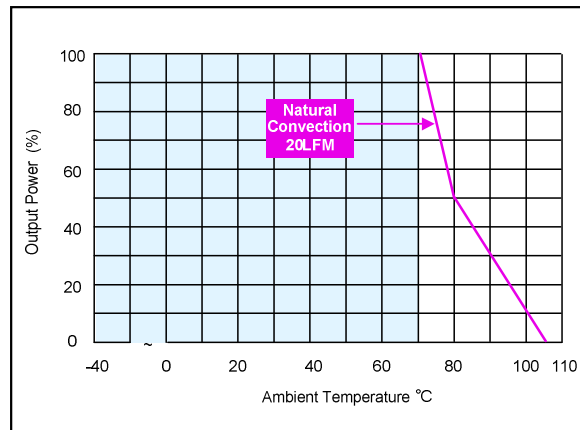

Figure 36: ATA02BB18-L Derating Output Current vs Ambient Temperature  
Vin = 24Vdc Load: Io = ±0.335A

## ATA02CC18-L Performance Curves

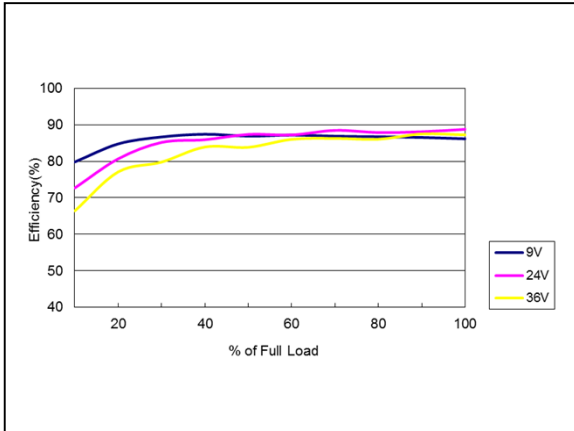

Figure 37: ATA02CC18-L Efficiency Versus Output Current Curve  
Vin = 9 to 36Vdc Load: Io = 0 to ±0.265A

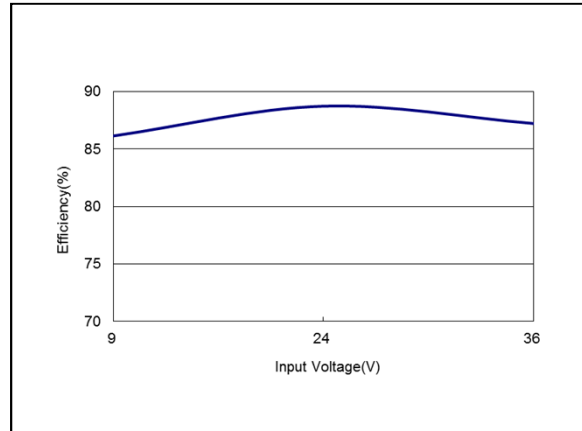

Figure 38: ATA02CC18-L Efficiency Versus Input Voltage Curve  
Vin = 9 to 36Vdc Load: Io = ±0.265A

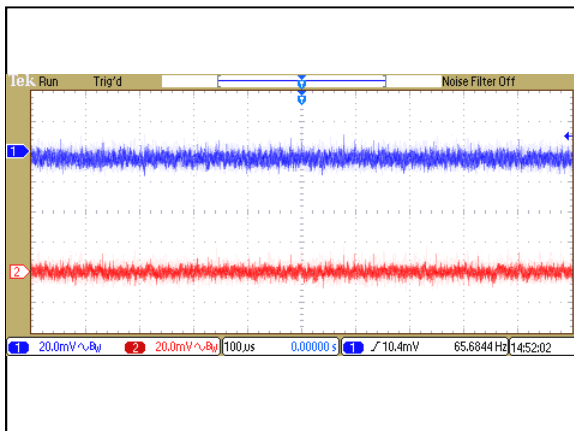

Figure 39: ATA02CC18-L Ripple and Noise Measurement  
Vin = 24Vdc Load: Io = ±0.265A  
Ch 1: Vo1 Ch 2: Vo2

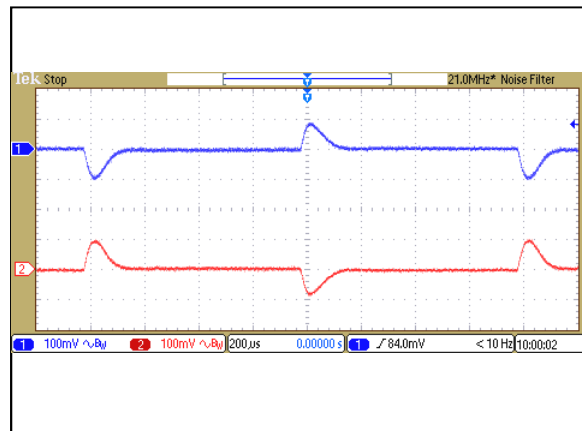

Figure 40: ATA02CC18-L Transient Response  
Vin = 24Vdc Load: Io = 100% to 75% load change  
Ch 1: Vo1 Ch 2: Vo2

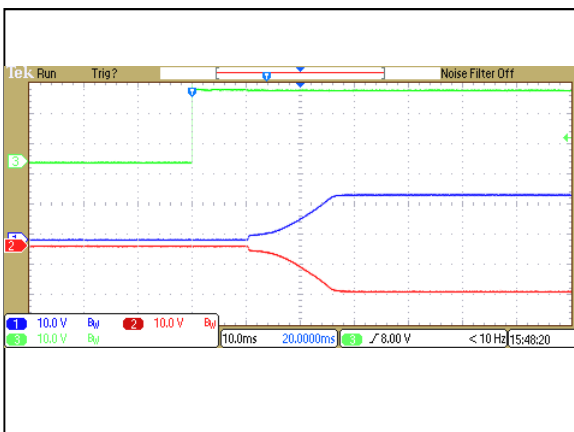

Figure 41: ATA02CC18-L Output Voltage Startup Characteristic by Vin  
Vin = 24Vdc Load: Io = ±0.265A  
Ch1: Vo1 Ch2:Vo2 Ch3: Vin

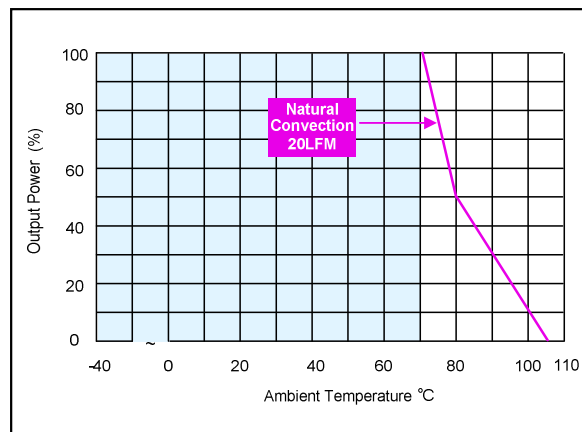

Figure 42: ATA02CC18-L Derating Output Current vs Ambient Temperature  
Vin = 24Vdc Load: Io = ±0.265A

## ATA02F36-L Performance Curves

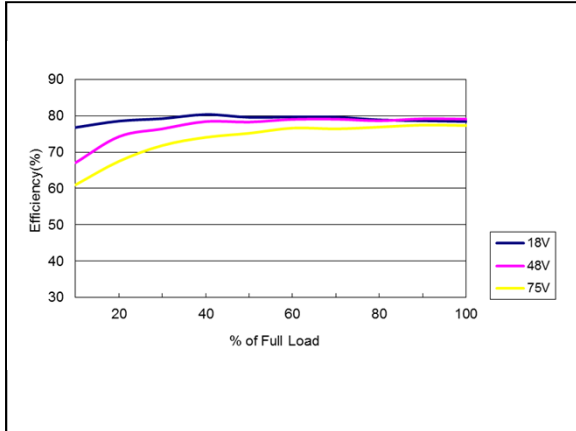

Figure 43: ATA02F36-L Efficiency Versus Output Current Curve  
Vin = 18 to 75Vdc Load: Io = 0 to 2A

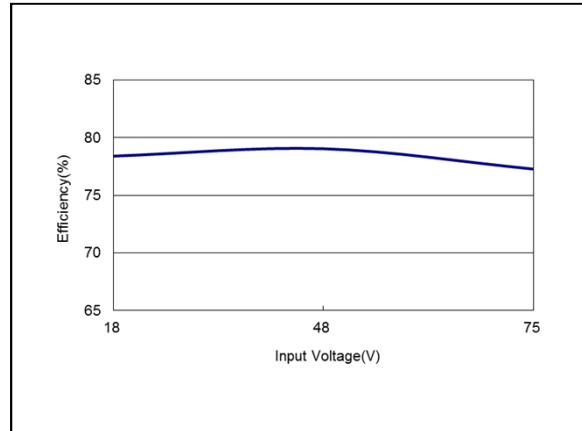

Figure 44: ATA02F36-L Efficiency Versus Input Voltage Curve  
Vin = 18 to 75Vdc Load: Io = 2A

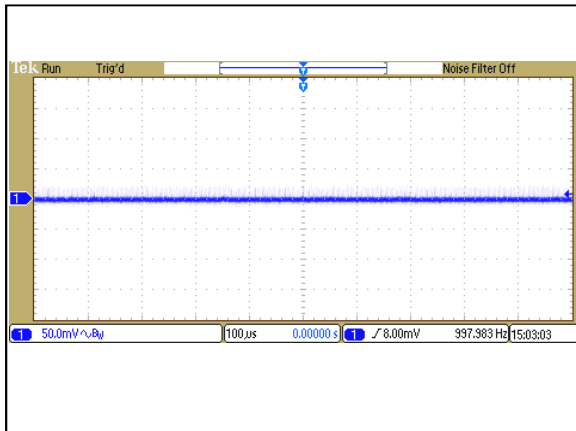

Figure 45: ATA02F36-L Ripple and Noise Measurement  
Vin = 48Vdc Load: Io = 2A  
Ch 1: Vo

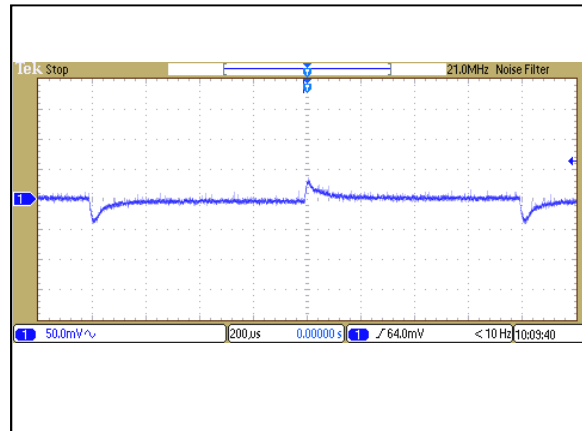

Figure 46: ATA02F36-L Transient Response  
Vin = 48Vdc Load: Io = 100% to 75% load change  
Ch 1: Vo

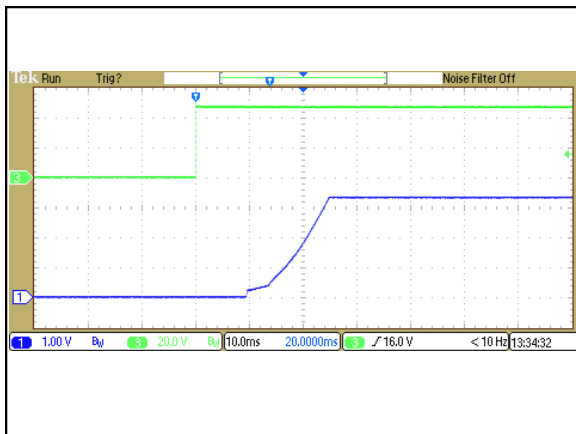

Figure 47: ATA02F36-L Output Voltage Startup Characteristic by Vin  
Vin = 48Vdc Load: Io = 2A  
Ch1: Vo Ch3: Vin

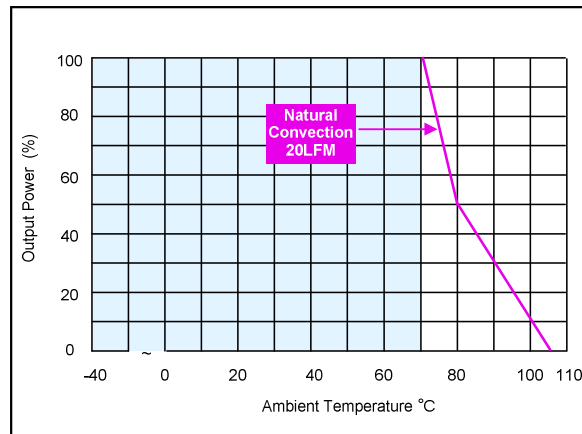

Figure 48: ATA02F36-L Derating Output Current vs Ambient Temperature  
Vin = 48Vdc Load: Io = 2A

## ATA02A36-L Performance Curves

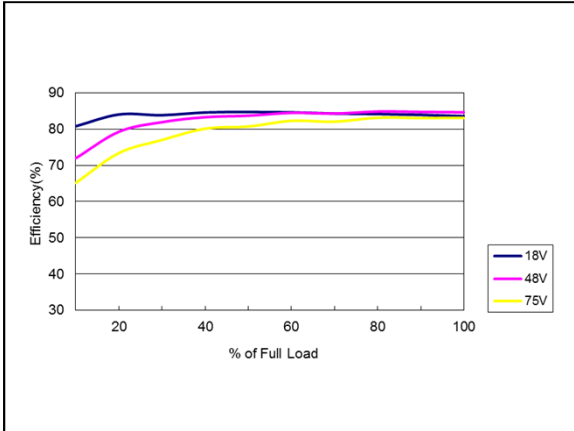

Figure 49: ATA02A36-L Efficiency Versus Output Current Curve  
Vin = 18 to 75Vdc Load: Io = 0 to 1.6A

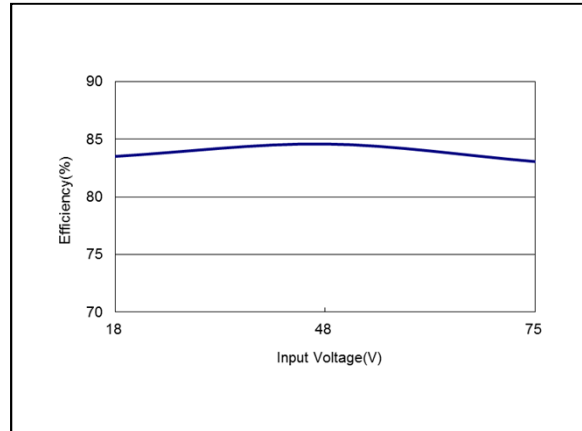

Figure 50: ATA02A36-L Efficiency Versus Input Voltage Curve  
Vin = 18 to 75Vdc Load: Io = 1.6A

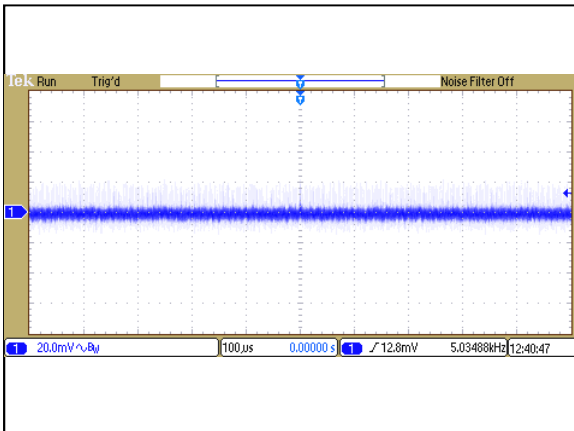

Figure 51: ATA02A36-L Ripple and Noise Measurement  
Vin = 48Vdc Load: Io = 1.6A  
Ch 1: Vo

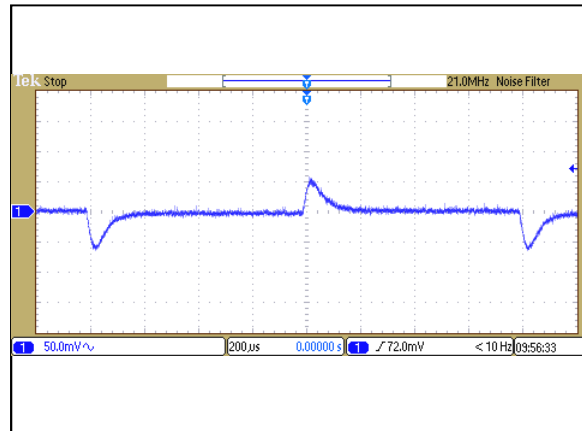

Figure 52: ATA02A36-L Transient Response  
Vin = 48Vdc Load: Io = 100% to 75% load change  
Ch 1: Vo

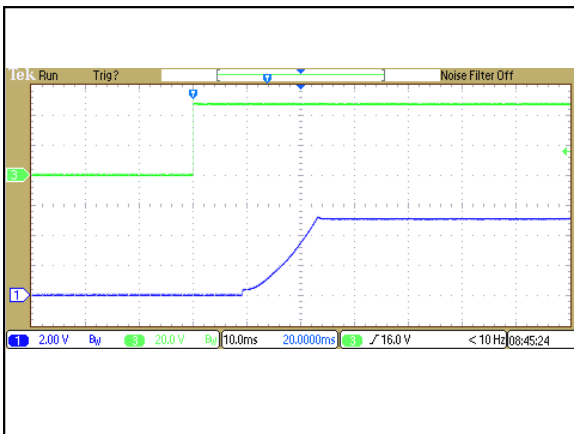

Figure 53: ATA02A36-L Output Voltage Startup Characteristic by Vin  
Vin = 48Vdc Load: Io = 1.6A  
Ch1: Vo Ch3: Vin

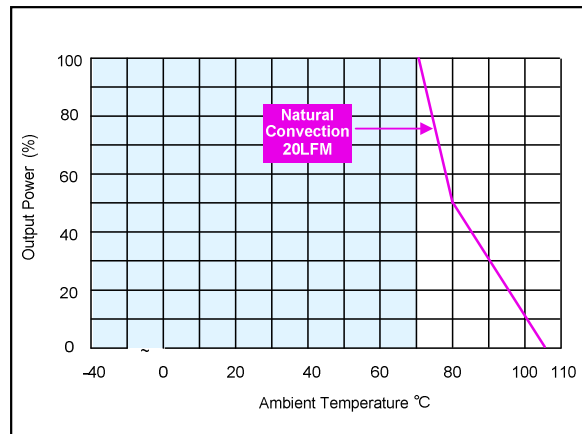

Figure 54: ATA02A36-L Derating Output Current vs Ambient Temperature  
Vin = 48Vdc Load: Io = 1.6A

## ATA02B36-L Performance Curves

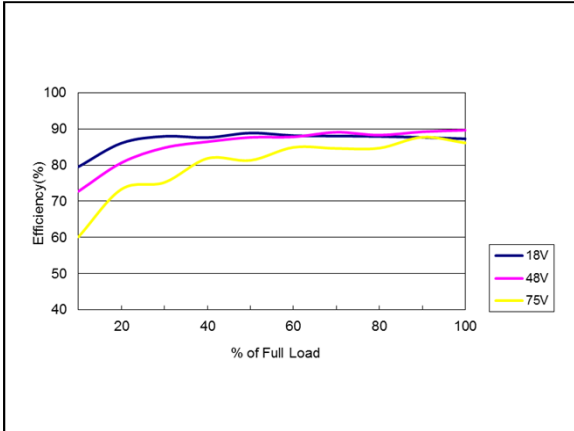

Figure 55: ATA02B36-L Efficiency Versus Output Current Curve  
Vin = 18 to 75Vdc Load: Io = 0 to 0.665A

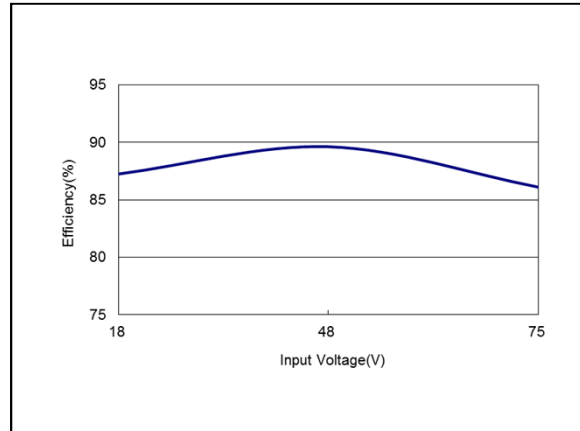

Figure 56: ATA02B36-L Efficiency Versus Input Voltage Curve  
Vin = 18 to 75Vdc Load: Io = 0.665A

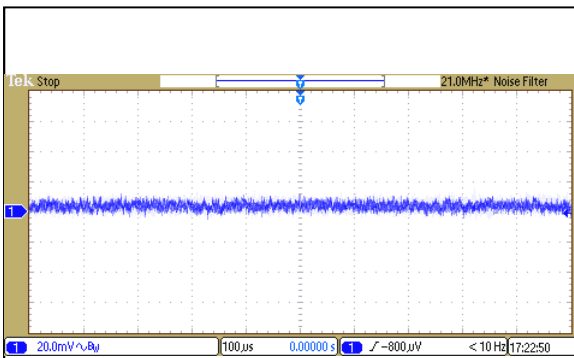

Figure 57: ATA02B36-L Ripple and Noise Measurement  
Vin = 48Vdc Load: Io = 0.665A  
Ch 1: Vo

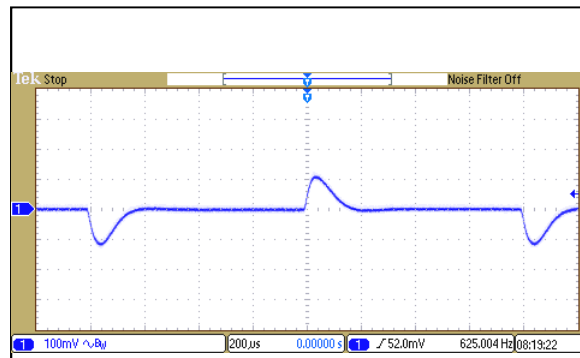

Figure 58: ATA02B36-L Transient Response  
Vin = 48Vdc Load: Io = 100% to 75% load change  
Ch 1: Vo

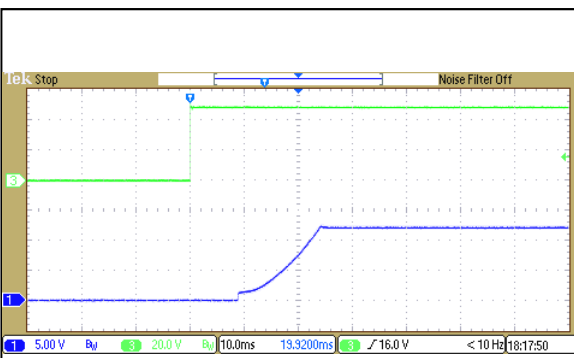

Figure 59: ATA02B36-L Output Voltage Startup Characteristic by Vin  
Vin = 48Vdc Load: Io = 0.665A  
Ch1: Vo Ch3: Vin

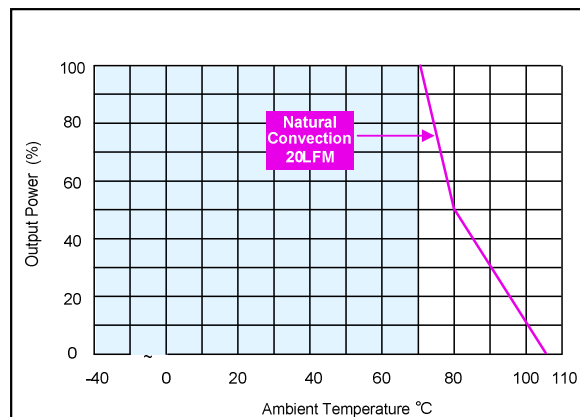

Figure 60: ATA02B36-L Derating Output Current vs Ambient Temperature  
Vin = 48Vdc Load: Io = 0.665A



## ATA02C36-L Performance Curves

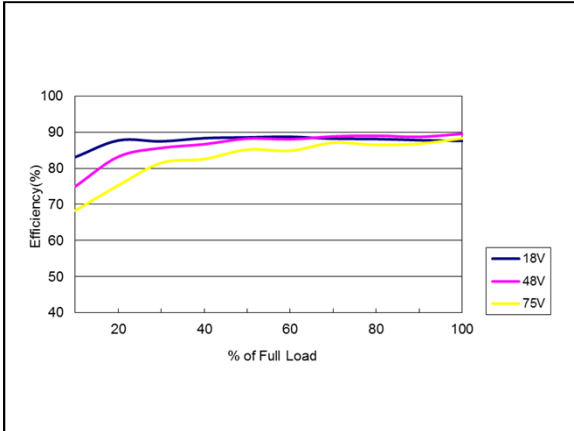

Figure 61: ATA02C36-L Efficiency Versus Output Current Curve  
Vin = 18 to 75Vdc Load: Io = 0 to 0.535A

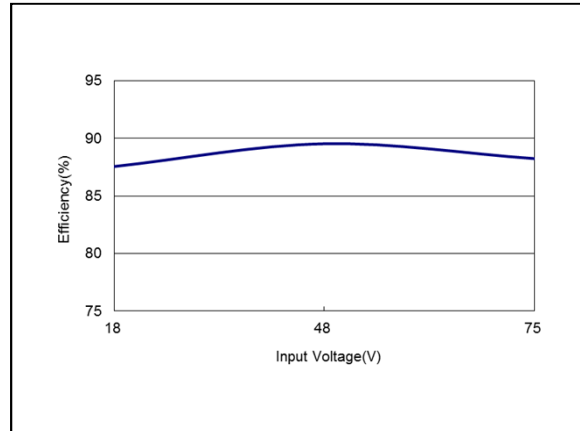

Figure 62: ATA02C36-L Efficiency Versus Input Voltage Curve  
Vin = 18 to 75Vdc Load: Io = 0.535A

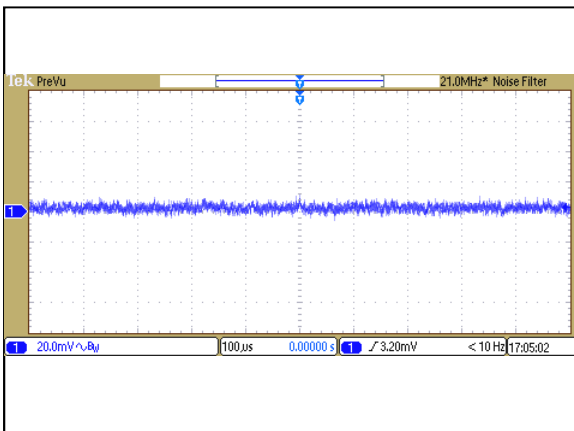

Figure 63: ATA02C36-L Ripple and Noise Measurement  
Vin = 48Vdc Load: Io = 0.535A  
Ch 1: Vo

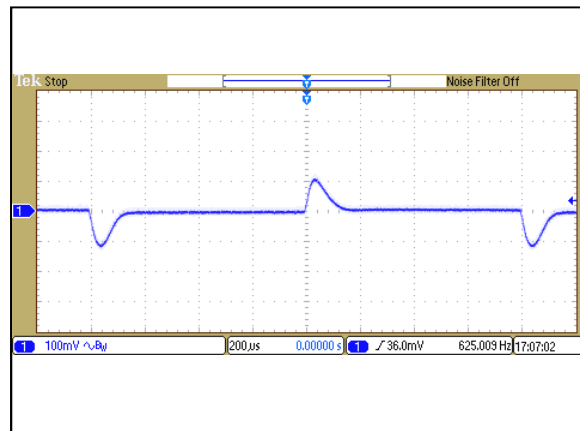

Figure 64: ATA02C36-L Transient Response  
Vin = 48Vdc Load: Io = 100% to 75% load change  
Ch 1: Vo

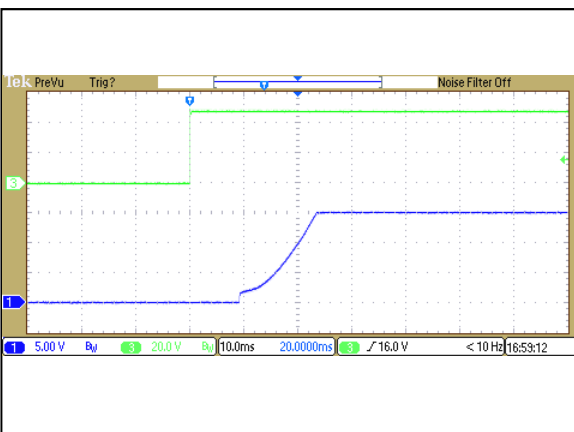

Figure 65: ATA02C36-L Output Voltage Startup Characteristic by Vin  
Vin = 48Vdc Load: Io = 0.535A  
Ch1: Vo Ch3: Vin

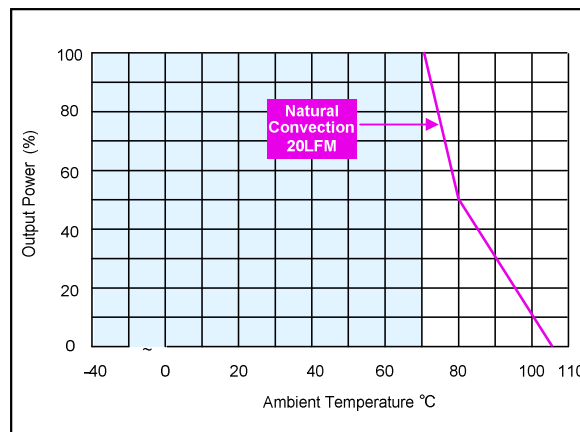

Figure 66: ATA02C36-L Derating Output Current vs Ambient Temperature  
Vin = 48Vdc Load: Io = 0.535A

## ATA02H36-L Performance Curves

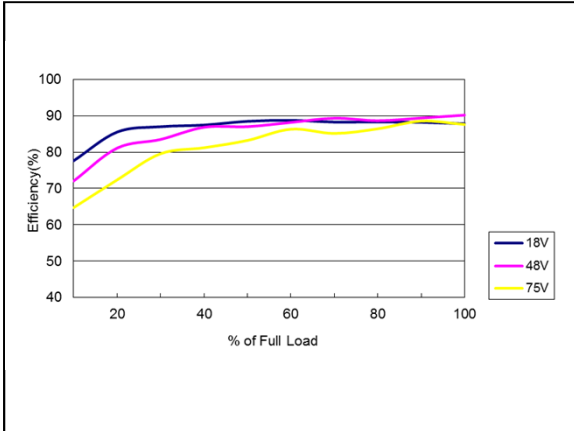

Figure 67: ATA02H36-L Efficiency Versus Output Current Curve  
Vin = 18 to 75Vdc Load: Io = 0 to 0.335A

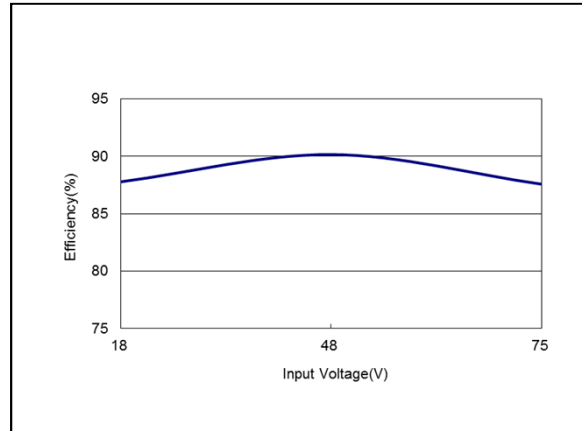

Figure 68: ATA02H36-L Efficiency Versus Input Voltage Curve  
Vin = 18 to 75Vdc Load: Io = 0.335A

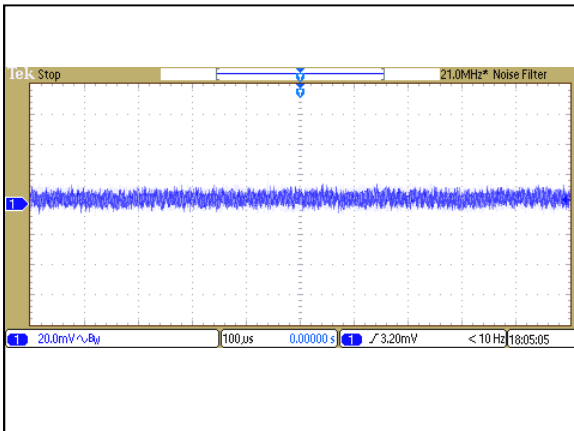

Figure 69: ATA02H36-L Ripple and Noise Measurement  
Vin = 48Vdc Load: Io = 0.335A  
Ch 1: Vo

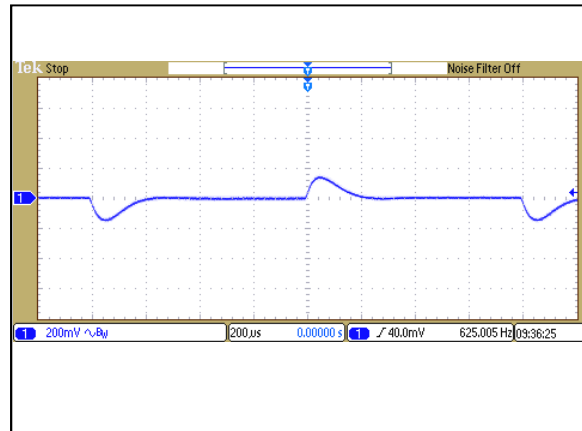

Figure 70: ATA02H36-L Transient Response  
Vin = 48Vdc Load: Io = 100% to 75% load change  
Ch 1: Vo

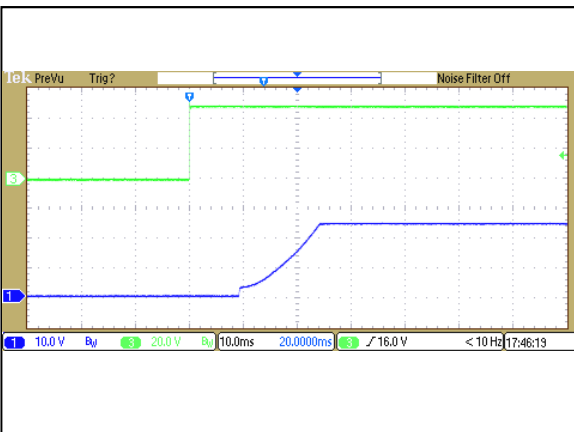

Figure 71: ATA02H36-L Output Voltage Startup Characteristic by Vin  
Vin = 48Vdc Load: Io = 0.335A  
Ch1: Vo Ch3: Vin

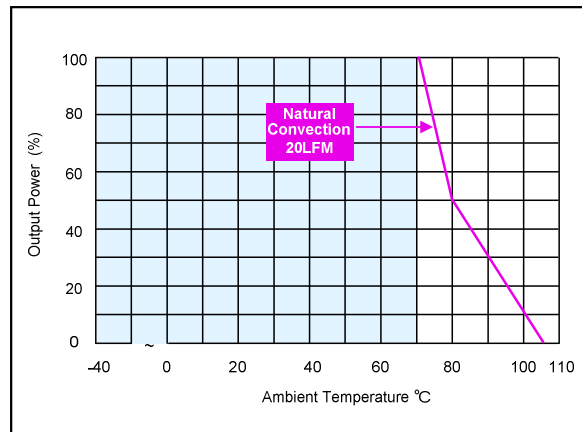

Figure 72: ATA02H36-L Derating Output Current vs Ambient Temperature  
Vin = 48Vdc Load: Io = 0.335A

## ATA02BB36-L Performance Curves

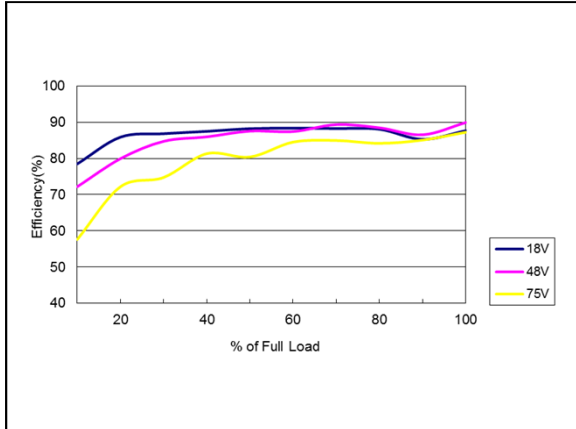

Figure 73: ATA02BB36-L Efficiency Versus Output Current Curve  
Vin = 18 to 75Vdc Load: Io = 0 to ±0.335A

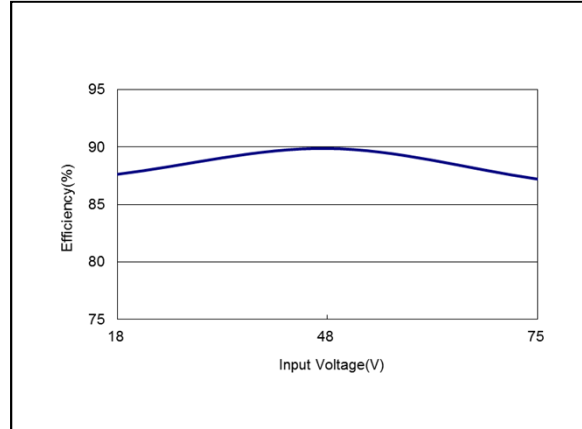

Figure 74: ATA02BB36-L Efficiency Versus Input Voltage Curve  
Vin = 18 to 75Vdc Load: Io = ±0.335A

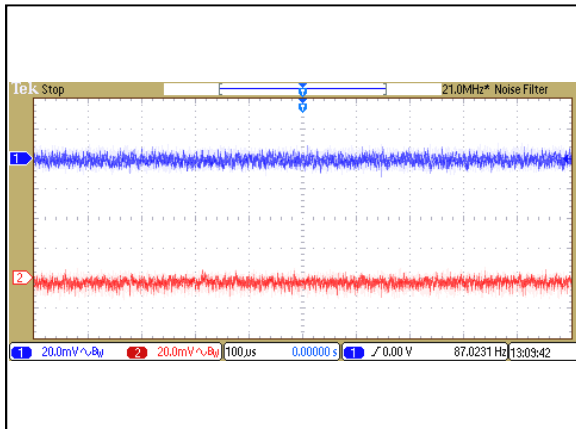

Figure 75: ATA02BB36-L Ripple and Noise Measurement  
Vin = 48Vdc Load: Io = ±0.335A  
Ch 1: Vo1 Ch 2: Vo2

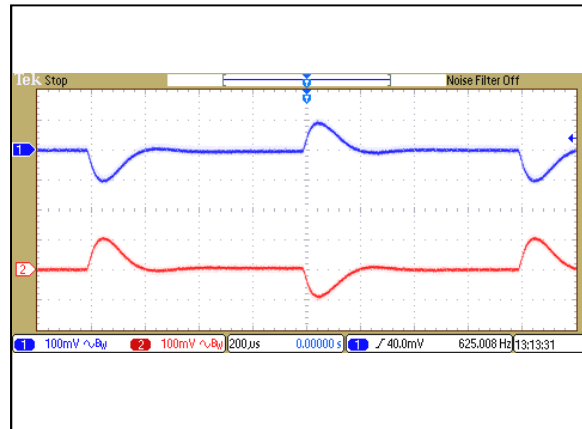

Figure 76: ATA02BB36-L Transient Response  
Vin = 48Vdc Load: Io = 100% to 75% load change  
Ch 1: Vo1 Ch 2: Vo2

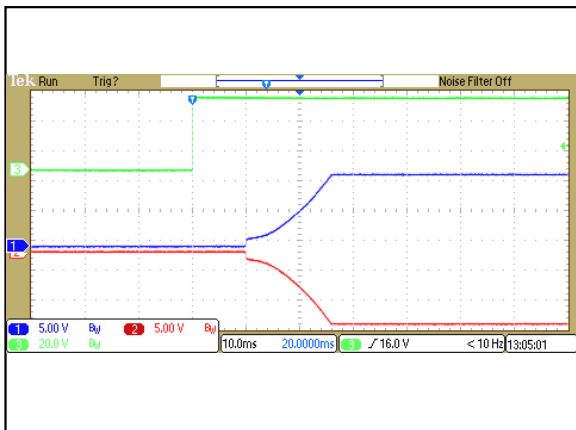

Figure 77: ATA02BB36-L Output Voltage Startup Characteristic by Vin  
Vin = 48Vdc Load: Io = ±0.335A  
Ch1: Vo1 Ch2:Vo2 Ch3: Vin

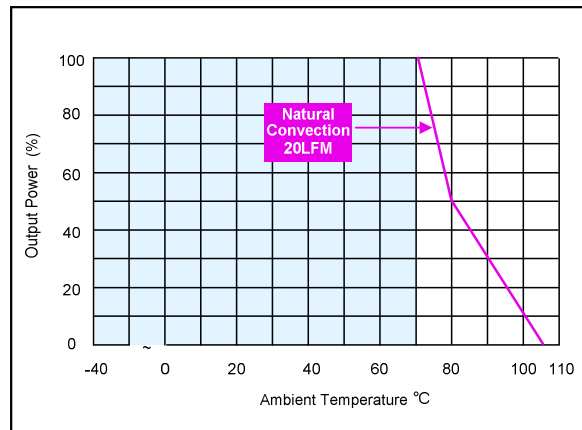

Figure 78: ATA02BB36-L Derating Output Current vs Ambient Temperature  
Vin = 48Vdc Load: Io = ±0.335A

## ATA02CC36-L Performance Curves

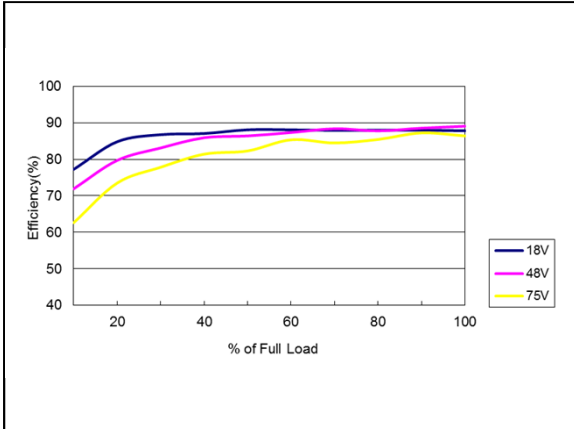

Figure 79: ATA02CC36-L Efficiency Versus Output Current Curve  
Vin = 18 to 75Vdc Load: Io = 0 to ±0.265A

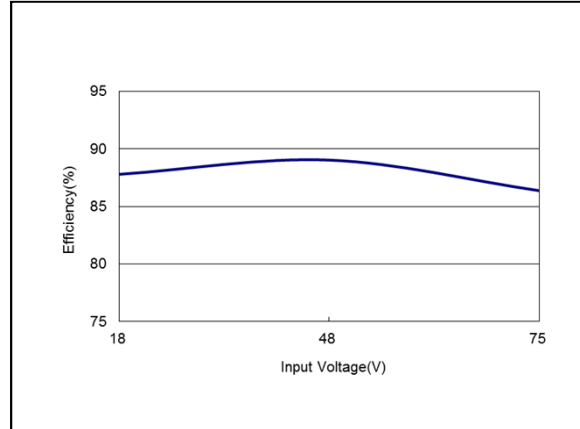

Figure 80: ATA02CC36-L Efficiency Versus Input Voltage Curve  
Vin = 18 to 75Vdc Load: Io = ±0.265A

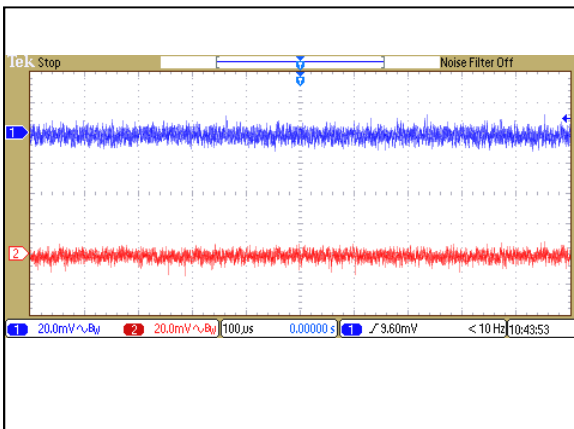

Figure 81: ATA02CC36-L Ripple and Noise Measurement  
Vin = 48Vdc Load: Io = ±0.265A  
Ch 1: Vo1 Ch 2: Vo2

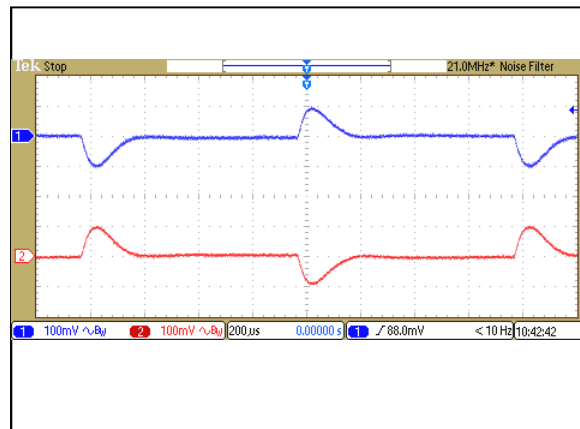

Figure 82: ATA02CC36-L Transient Response  
Vin = 48Vdc Load: Io = 100% to 75% load change  
Ch 1: Vo1 Ch 2: Vo2

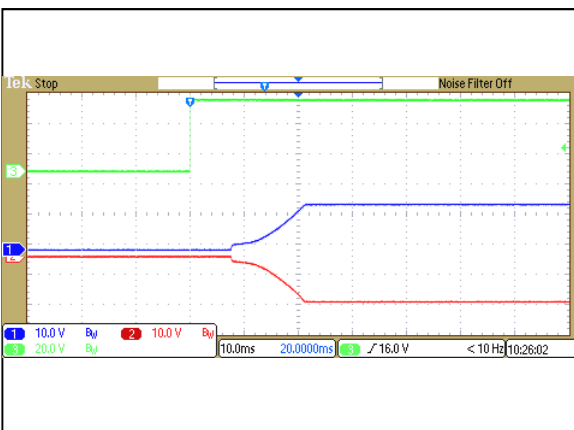

Figure 83: ATA02CC36-L Output Voltage Startup Characteristic by Vin  
Vin = 48Vdc Load: Io = ±0.265A  
Ch1: Vo1 Ch2:Vo2 Ch3: Vin

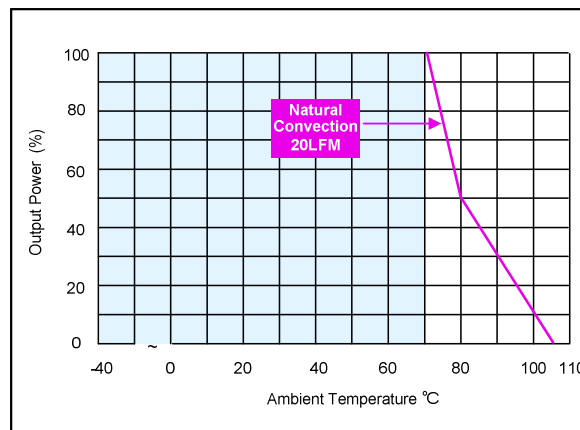
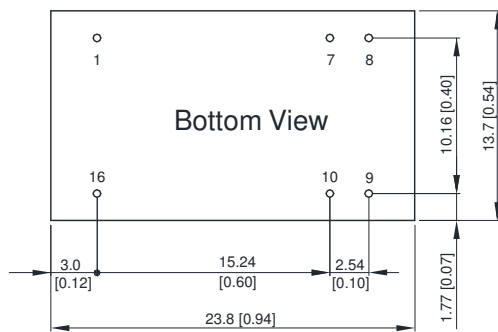
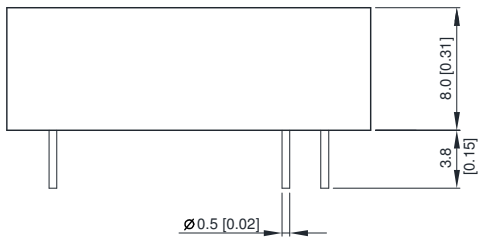

Figure 84: ATA02CC36-L Derating Output Current vs Ambient Temperature  
Vin = 48Vdc Load: Io = ±0.265A

## Mechanical Specifications

### Mechanical Outlines



**Note:**

1. All dimensions in mm (inches)
2. Tolerance: X.X $\pm$ 0.5 (X.XX $\pm$ 0.02)  
X.XX $\pm$ 0.25 (X.XXX $\pm$ 0.01)
3. Pin diameter 0.5  $\pm$ 0.05 (0.02 $\pm$ 0.002)
4. No Connection

### Pin Connections

#### Single output

- Pin 1 – -Vin
- Pin 7 – NC<sup>4</sup>
- Pin 8 – No Pin
- Pin 9 – +Vout
- Pin 10 – -Vout
- Pin 16 – +Vin

#### Dual Output

- Pin 1 – -Vin
- Pin 7 – No Pin
- Pin 8 – Common
- Pin 9 – +Vout
- Pin 10 – -Vout
- Pin 16 – +Vin

Physical Characteristics	
Case Size	23.8x13.7x8.0 mm (0.94x0.54x0.31 inches)
Case Material	Aluminium Alloy, Black Anodized Coating
Pin Material	Tinned Copper
Weight	6.1g

**Recommended Pad Layout**

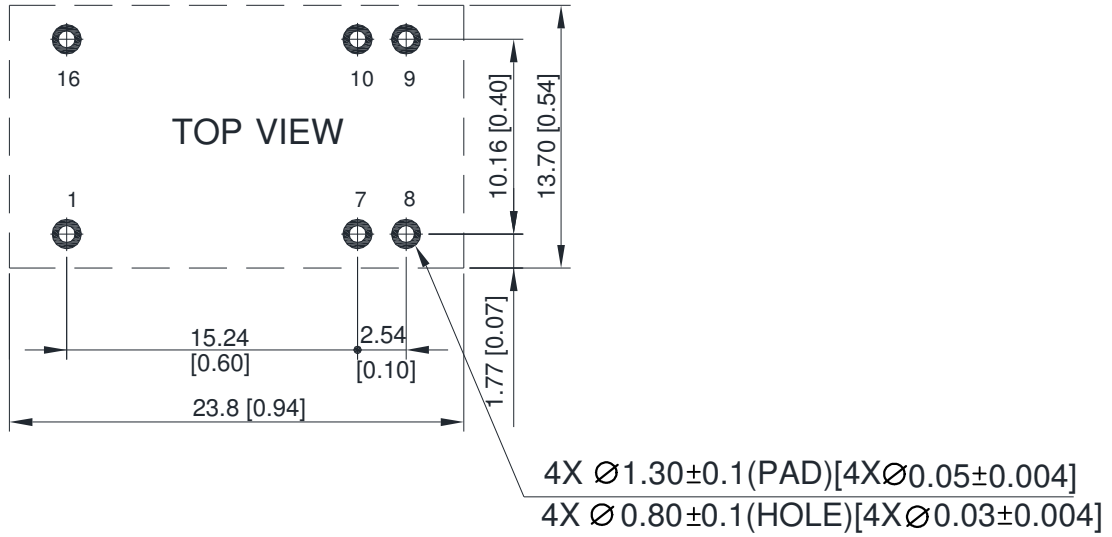

## Environmental Specifications

### EMC Immunity

ATA 8W series power supply is designed to meet the following EMC immunity specifications.

Table 4. EMC Specifications:

Parameter	Standards & Level		Performance
EMI	Conduction	EN55032, EN55022, FCC part15	Class A
EMS	EN55024		
	ESD	EN61000-4-2 Air $\pm 8kV$ , Contact $\pm 6kV$	Perf. Criteria A
	Radiated immunity	EN61000-4-3 20V/m	
	Fast transient <sup>1</sup>	EN61000-4-4 $\pm 2KV$	Perf. Criteria A
	Surge <sup>1</sup>	EN61000-4-5 $\pm 1KV$	Perf. Criteria A
	Conducted immunity	EN61000-4-6 10Vrms	Perf. Criteria A
	PfMF	EN61000-4-8 100A/M, 1000A/m(1sec.)	Perf. Criteria A

Note 1: To meet EN61000-4-4 & EN61000-4-5, an external capacitor across the input pins is required.  
Suggested capacitor: 220 $\mu$ F/100V.

## **Safety Certifications**

The ATA 8W series power supply is intended for inclusion in other equipment and the installer must ensure that it is in compliance with all the requirements of the end application. This product is only for inclusion by professional installers within other equipment and must not be operated as a stand alone product.

Table 5. Safety Certifications for ATA 8W series power supply system

<b>Document</b>	<b>Description</b>
cUL/UL 60950-1 (UL certificate)	US Requirements
IEC/EN 60950-1 (CB-scheme)	European Requirements (All CENELEC Countries)
CE mark	



## Operating Temperature

Table 6. Operating Temperature:

Parameter	Model / Condition	Min	Max	Unit
Operating Temperature Range (Natural Convection <sup>1</sup> , See Derating)	All	-40	+80	°C
Operating Case Temperature	All	-	+105	°C
Storage Temperature Range		-50	+125	°C
Cooling	Natural Convection			
Lead Temperature (1.5mm from case for 10Sec.)		-	260	°C

Note1 - The "natural convection" is about 20LFM but is not equal to still air (0 LFM).

## MTBF and Reliability

The MTBF of ATA 8W series of DC/DC converters has been calculated using MIL-HDBK 217F NOTICE2, Operating Temperature 25 °C, Ground Benign.

Model	MTBF	Unit
ATA02F18-L	2,358,263	Hours
ATA02A18-L	2,484,618	
ATA02B18-L	3,500,129	
ATA02C18-L	3,522,739	
ATA02H18-L	3,496,433	
ATA02BB18-L	3,619,712	
ATA02CC18-L	3,508,652	
ATA02F36-L	2,413,507	
ATA02A36-L	2,464,316	
ATA02B36-L	3,772,726	
ATA02C36-L	3,703,353	
ATA02H36-L	3,747,978	
ATA02BB36-L	3,661,783	
ATA02CC36-L	3,571,139	

## Application Notes

### Peak-to-Peak Output Noise Measurement Test

Use a  $C_{out}$  0.47 $\mu$ F ceramic capacitor. Scope measurement should be made by using a BNC socket, measurement bandwidth is 0-20MHz. Position the load between 50 mm and 75 mm from the DC/DC Converter.

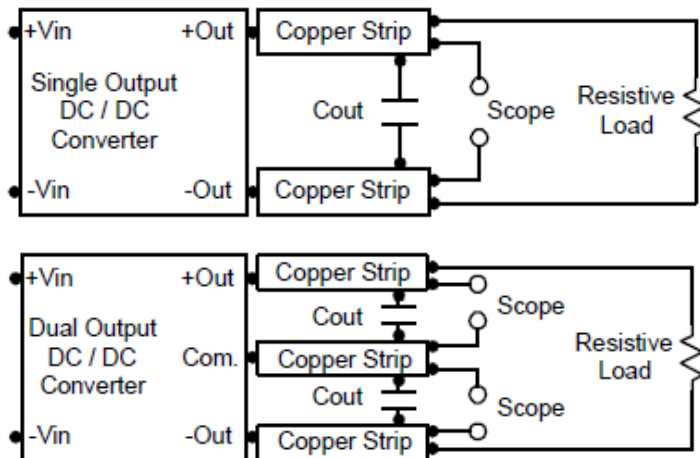

### Output Over Current Protection

To provide hiccup mode protection in a fault (output overload) condition, the unit is equipped with internal current limiting circuitry and can endure overload for an unlimited duration. At the point of current-limit inception, the unit shifts from voltage control to current control. The unit operates normally once the output current is brought back into its specified range.

### Input Source Impedance

The power module should be connected to a low ac-impedance input source. Highly inductive source impedances can affect the stability of the power module. In applications where power is supplied over long lines and output loading is high, it may be necessary to use a capacitor at the input to ensure startup. Capacitor mounted close to the power module helps ensure stability of the unit, it is recommended to use a good quality low Equivalent Series Resistance ( $ESR < 1.0\Omega$  at 100 kHz) capacitor of a 2.2 $\mu$ F for the 24V and 48V devices.

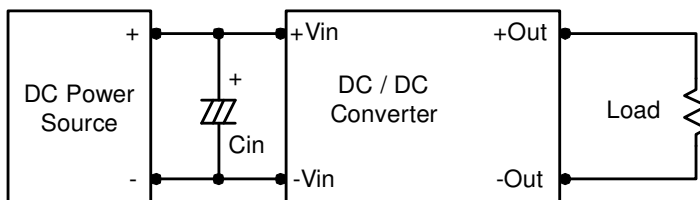

## Output Ripple Reduction

A good quality low ESR capacitor placed as close as practicable across the load will give the best ripple and noise performance. To reduce output ripple, it is recommended to use 3.3uF capacitors at the output.

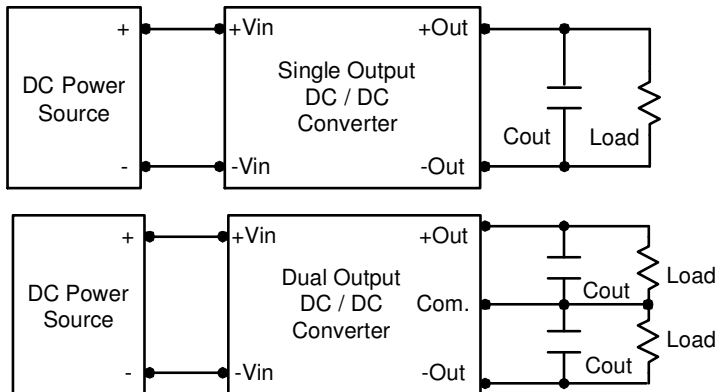

## Maximum Capacitive Load

The ATA 8W series has limitation of maximum connected capacitance at the output. The power module may be operated in current limiting mode during start-up, affecting the ramp-up and the startup time. The maximum capacitance can be found in the data sheet.

## Thermal Considerations

Many conditions affect the thermal performance of the power module, such as orientation, airflow over the module and board spacing. To avoid exceeding the maximum temperature rating of the components inside the power module, the case temperature must be kept below 105°C.

The derating curves are determined from measurements obtained in a test setup.

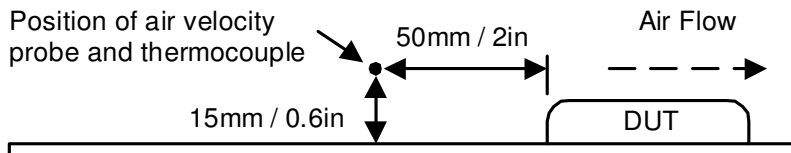

## Packaging Information

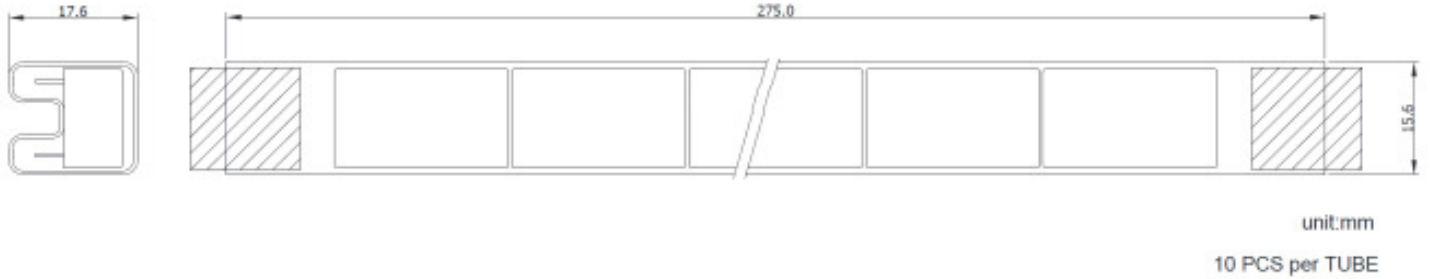

## Soldering and Reflow Considerations

Lead free wave solder profile for ATA 8W Series.

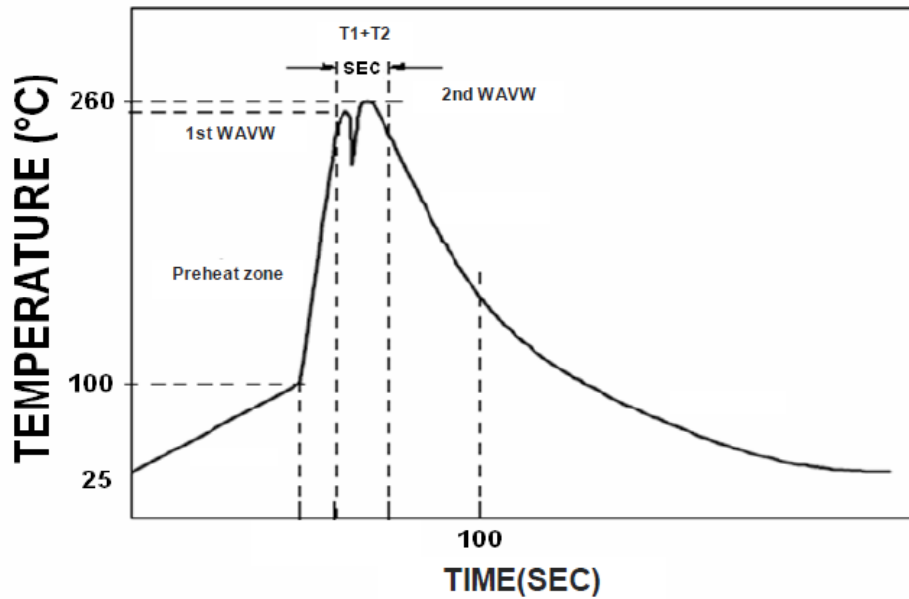

Zone	Reference Parameter
Preheat zone	Rise temp speed: 3°C/sec max.
	Preheat temp: 100~130°C
Actual heating	Peak temp: 250~260°C Peak Time
	Peak time(T1+T2): 4~6 sec

Reference Solder: Sn-Ag-Cu; Sn-Cu; Sn-Ag  
Hand Welding: Soldering iron: Power 60W  
Welding Time: 2~4 sec  
Temp.: 380~400 °C

## Record of Revision and Changes

Issue	Date	Description	Originators
1.0	03.07.2017	First Issue	A. Zhang

### WORLDWIDE OFFICES

#### Americas

2900 South Diablo Way  
Suite B100  
Tempe, AZ 85282  
USA  
+1 888 412 7832

#### Europe (UK)

Ground Floor Offices  
Barberry House, 4 Harbour Buildings  
Waterfront West, Brierley Hill  
West Midlands, DY5 1LN, UK  
+44 (0) 1384 842 211

#### Asia (HK)

14/F, Lu Plaza  
2 Wing Yip Street  
Kwun Tong, Kowloon  
Hong Kong  
+852 2176 3333

**ARTESYN**<sup>TM</sup>  
An Advanced Energy Company  
[www.artesyn.com](http://www.artesyn.com)

For more information: [www.artesyn.com](http://www.artesyn.com)  
For support: [productsupport.ep@artesyn.com](mailto:productsupport.ep@artesyn.com)

Artesyn Embedded Technologies, Artesyn Embedded Power, Artesyn, and all Artesyn related logos are trademarks and service marks of Artesyn Embedded Technologies, Inc. All other names and logos referred to are trade names, trademarks, or registered trademarks of their respective owners. Specifications are subject to change without notice. © 2019 Artesyn Embedded Technologies, Inc. All rights reserved. For full legal terms and conditions, please visit [www.artesyn.com/legal](http://www.artesyn.com/legal).