

Powerex, Inc., 200 Hillis Street, Youngwood, Pennsylvania 15697-1800 (412) 925-7272  
 Powerex, Europe, S.A. 428 Avenue G. Durand, BP107, 72003 Le Mans, France (43) 41.14.14

### High Power General Purpose Rectifier 7000 Amperes Average 600 Volts

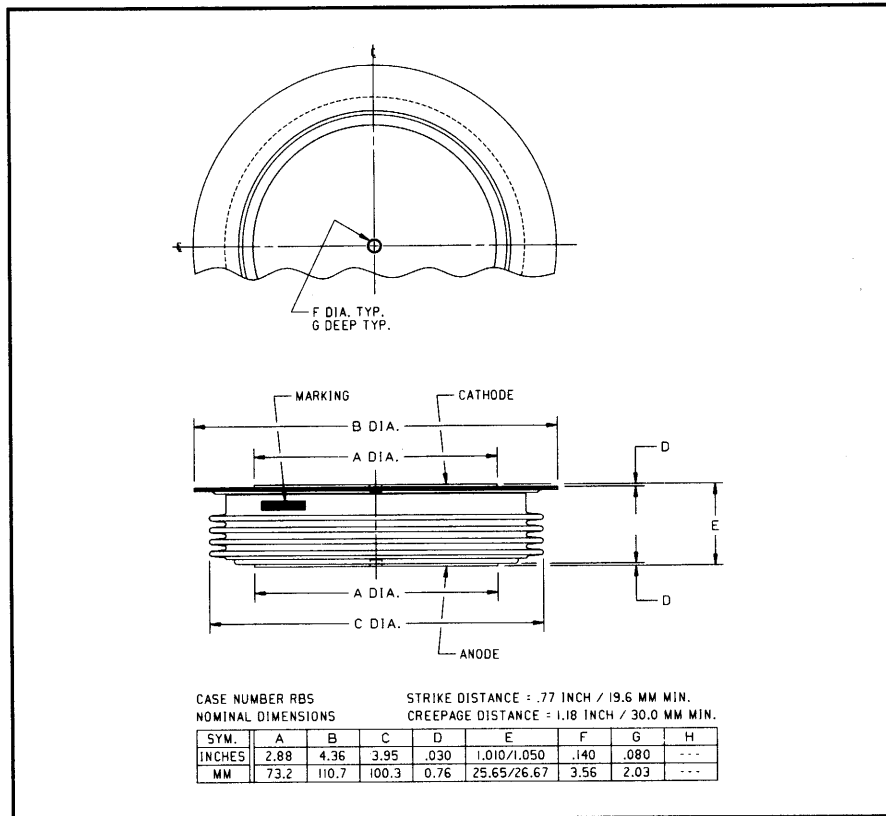

RBS8 7000A (Outline Drawing)

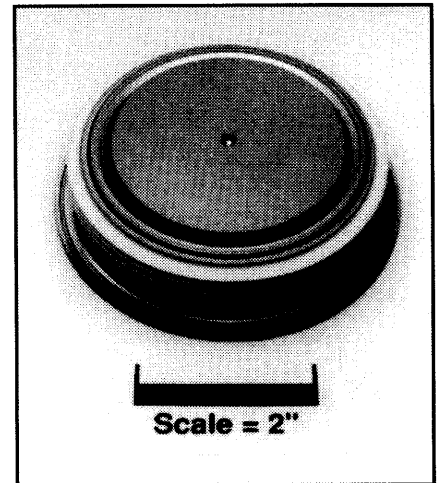

RBS8 7000A  
High Power  
General Purpose Rectifier  
7000 Amperes Average, 600 Volts

#### Description:

The RBS8 is a low voltage, high current rectifier in a thin, low profile package with improved thermal capability. Powerex High Power Rectifiers are designed for use in applications requiring reliable general purpose rectification of high currents.

#### Features:

- Low Forward Voltage
- Low Thermal Impedance
- Low Profile Package
- Hermetic Packaging
- Excellent Surge and  $I^2t$  Ratings

#### Applications:

- Power Supplies
- AC and DC Motor Control
- VAR Generators

#### Ordering Information:

Select the complete 8 digit part number you desire from the table below.

Type	Voltage	Current	Typical Recovery Time
	$V_{RRM}$ (Volts)	$I_T(av)$ (A)	$t_{rr}$ ( $\mu$ sec)
RBS8	02 04 06	70	XX
	200V 400V 600V	7000A	25 $\mu$ sec



Powerex, Inc., 200 Hillis Street, Youngwood, Pennsylvania 15697-1800 (412) 925-7272  
Powerex, Europe, S.A. 428 Avenue G. Durand, BP107, 72003 Le Mans, France (43) 41.14.14

**RBS8 7000A**  
**High Power General Purpose Rectifier**  
7000 Amperes Average, 600 Volts

### Absolute Maximum Ratings

Characteristics	Symbol	RBS8 7000A	Units
Non-repetitive Transient Peak Reverse Voltage	$V_{RSM}$	$V_{RRM} + 200V$	Volts
RMS Forward Current, $T_C = 79^\circ C$	$I_{F(rms)}$	11000	Amperes
Average Current 180° Sine Wave, $T_C = 79^\circ C$	$I_{F(av)}$	7000	Amperes
RMS Forward Current, $T_C = 55^\circ C$	$I_{F(rms)}$	12440	Amperes
Average Current 180° Sine Wave, $T_C = 55^\circ C$	$I_{F(av)}$	7925	Amperes
Peak One Cycle Surge Forward Current (Non-repetitive) 60Hz	$I_{fsm}$	60000	Amperes
Peak One Cycle Surge Forward Current (Non-repetitive) 50Hz	$I_{fsm}$	55000	Amperes
$I^2t$ (for Fusing) for One Cycle, 60Hz	$I^2t$	$15 \times 10^6$	$A^2sec$
Operating Temperature	$T_j$	-40 to +175°C	°C
Storage Temperature	$T_{stg}$	-40 to +175°C	°C
Approximate Weight		2.5	lb.
		1.1	kg
Mounting Force		6000 to 10000	lb.
		26.6 to 44.4	kN



Powerex, Inc., 200 Hillis Street, Youngwood, Pennsylvania 15697-1800 (412) 925-7272  
 Powerex, Europe, S.A. 428 Avenue G. Durand, BP107, 72003 Le Mans, France (43) 41.14.14

**RBS8 7000A**

**High Power General Purpose Rectifier**  
 7000 Amperes Average, 600 Volts

**Electrical Characteristics,  $T_j = 25^\circ\text{C}$  Unless Otherwise Specified**

Characteristics	Symbol	Test Conditions	Min.	Typ.	Max.	Units
Peak Reverse Leakage Current	$I_{RRM}$	$T_j = 175^\circ\text{C}, V_R = V_{RRM}$			100	mA
Forward Voltage Drop	$V_{FM}$	$I_{FM} = 3000\text{A}, \text{Duty Cycle} < 0.1\%$			0.90	Volts
Threshold Voltage, Low-level	$V_{(TO)1}$	$T_j = 125^\circ\text{C}, I = 15\%, I_{T(av)}$ to $\pi I_{T(av)}$			0.64564	Volts
Slope Resistance, Low-level	$r_{T1}$				0.04421	m $\Omega$
Threshold Voltage, High-level	$V_{(TO)2}$	$T_j = 125^\circ\text{C}, I = \pi I_{T(av)}$ to $I_{TSM}$			0.64880	Volts
Slope Resistance, High-level	$r_{T2}$				0.04539	m $\Omega$
$V_{TM}$ Coefficients, Low-level		$T_j = 125^\circ\text{C}, I = 15\% I_{T(av)}$ to $\pi I_{T(av)}$				
					$A_1 = 0.042466$	
					$B_1 = 0.12757$	
					$C_1 = 7.653\text{E-}05$	
					$D_1 = -0.009271$	
$V_{TM}$ Coefficients, High-level		$T_j = 125^\circ\text{C}, I = \pi I_{T(av)}$ to $I_{TSM}$				
					$A_2 = 1.7705$	
					$B_2 = -0.24559$	
					$C_2 = 6.379\text{E-}06$	
					$D_2 = 0.01468$	
Typical Reverse Recovery Time	$t_{rr}$	$T_C = 25^\circ\text{C}, I_{FM} = 1500\text{A},$ $di_F/dt = 25\text{A}/\mu\text{sec}$		25		$\mu\text{sec}$

**Thermal Characteristics**

Maximum Thermal Resistance, Double Sided Cooling

Junction-to-Case	$R_{\theta(j-c)}$		0.0095	$^\circ\text{C}/\text{W}$
Case-to-Sink	$R_{\theta(c-s)}$		0.002	$^\circ\text{C}/\text{W}$

Powerex, Inc., 200 Hillis Street, Youngwood, Pennsylvania 15697-1800 (412) 925-7272  
 Powerex, Europe, S.A. 428 Avenue G. Durand, BP107, 72003 Le Mans, France (43) 41.14.14

**RBS8 7000A**  
 High Power General Purpose Rectifier  
 7000 Amperes Average, 600 Volts

**Maximum On-State Forward Voltage Drop**  
 (T<sub>J</sub> = 175 °C)

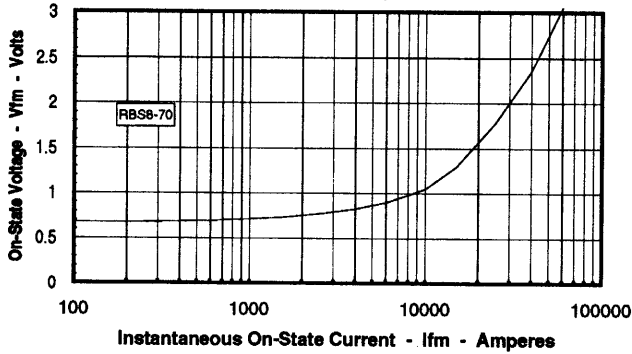

**Maximum Transient Thermal Impedance**  
 (Junction to Case)

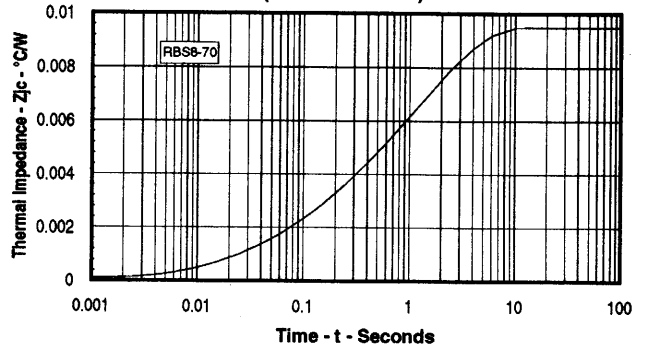

**Maximum On-State Power Dissipation**  
 (Sinusoidal Waveform)

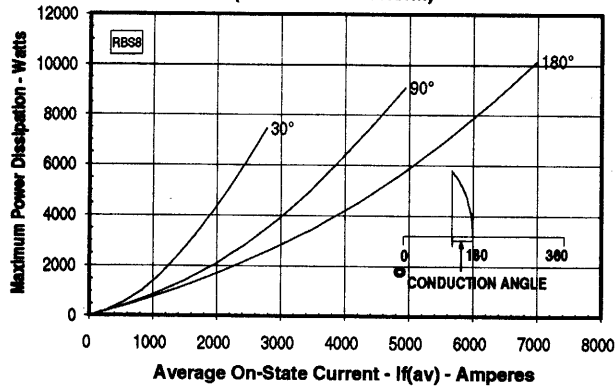

**Maximum Allowable Case Temperature**  
 (Sinusoidal Waveform)

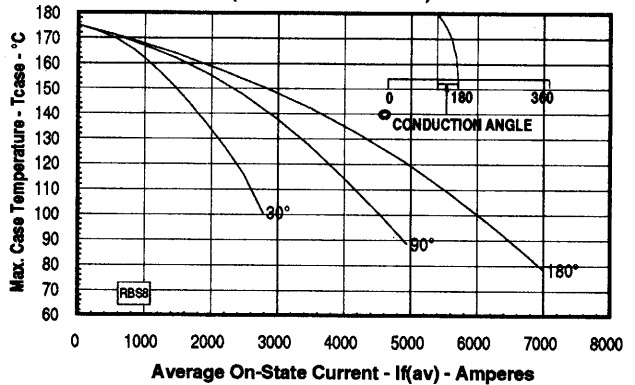

**Maximum On-State Power Dissipation**  
 (Rectangular Waveform)

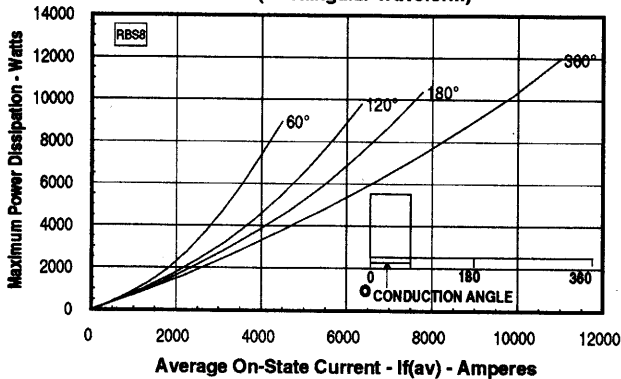

**Maximum Allowable Case Temperature**  
 (Rectangular Waveform)

