



General data

The RS 76 full-travel keyswitches are designed for configuring keyboards. They offer very comfortable operation with an overall height of 15.5 / 15.9 mm and a key travel of 4 mm.

The modular system with a grid of 3/4" = 19.05 mm enables you to design any key block you may want. **Mechanical contact system RS 76 M**

A gold alloy is used as the contact material and provides high contact reliability, low contact resistance and short bouncing time. **Solid-state contact system RS 76 C**

The solid-state switch in Hall-IC technology ensures bounce-free and wear-free switching and a long operating life. Function: When pressing the keys, a permanent magnet changes its position relative to the Hall-IC and thereby generates an output signal.

Their use is especially recommended in hostile environments and for heavy duty applications.

Content

RS 76 M full-travel keyswitch, non-illuminated	4 - 126
RS 76 M keyswitch, non-illuminated	4 - 127
RS 76 M keyswitch with diode, non-illuminated	4 - 127
RS 76 M keyswitch, illuminated	4 - 128
RS 76 M keyswitch, illuminated, momentary	4 - 129
RS 76 M keyswitch, illuminated, latching	4 - 129
RS 76 MX keyswitch, fully illuminated	4 - 130
RS 76 C keyswitch, non-illuminated	4 - 132
RS 76 C keyswitch, non-illuminated	4 - 133
RS 76 C keyswitch, illuminated	4 - 134
RS 76 C keyswitch, illuminated, momentary	4 - 135
RS 76 C keyswitch, illuminated, latching	4 - 135
Keycaps for RS 76, non-illuminated	4 - 136
Keycap for RS 76, opaque	4 - 136
Keycap for RS 76, opaque, with nail protection	4 - 137
Keycap for RS 76 with legend insert	4 - 137
Keycaps for RS 76, illuminated	4 - 138
Keycap for RS 76 with light bar	4 - 138
Keycap for RS 76, illuminated, with legend insert	4 - 139
Keycap for RS 76, illuminated, with nail protection and legend insert	4 - 139
Keycap for RS 76, illuminated, with legend insert	4 - 140
Keycap, fully illuminated, for RS 76 MX	4 - 140
Keycaps for RS 76, with legend, two-shot moulded/keycap sets	4 - 142
Keycap set for RS 76, symbols A-Z	4 - 142
Keycap set for RS 76, symbols 0-9	4 - 143
RS 76 accessories	4 - 144
Cover for RS 76 IP40	4 - 144
PCB Keyswitches	4 - 119

Stock items are marked by **bold printed** order numbers.

The Rafi full-travel keyswitches RS 76 are modular systems for designing individual key blocks and keyboards in the 3/4 inch (= 19.05 mm) grid.

Definitions

Momentary keyswitches

Momentary keyswitches return to their initial position after being pressed (momentary action).

Latching keyswitches

Latching keyswitches lock when actuated and are returned to their initial position when pressed again (push-push action).

Keycap materials

Keycap without legend insert: ABS

Keycap with legend insert:

– Keycap body: ABS

– Lens: PC

Keycap, n-module

A 2-module keycap f. ex. has the twofold length of a 1-module keycap.

Contact principle

There are two contact principles:

– **Mechanical (M):** Cross contact (RS 76 M)
Bridge contact
(RS 76 M, illuminated)

– **Contactless (C):** Based on Hall-IC (RS 76 C)

Soldering

The soldering temperature should not exceed 250 °C, the soldering time not be longer than 3 seconds.

All RS 76 C-keyswitches can be soldered in solder baths.

The assembled PCB should be cleaned only by using

brushing machines from the soldering side of the PCB.

The cleaning agent should not exceed the component side of the PCB.

All keyswitches can be flow-soldered, provided that an acid fluxer is used and that the whole unit is cleaned afterwards in de-ionised water.

Cleaning

Keyswitches should not be washed in freon or similar substances as a lubricant is used, otherwise the operating life of the keyswitches will be reduced.

If complete keyboards are to be cleaned by dipping, it must be remembered that they keyboard may only be dipped in the dipping solution as far as the component side of the PCB.

Legending of keycaps

Keycaps can be legended by different methods:

Two-shot moulding

Using this method the symbol is separately manufactured from a plastic and then the appropriate keycap form is moulded round it. Advantage: The character becomes a integrated part of the keycap, thus eliminating abrasion. All Rafi keycap sets with standard legending are manufactured by this method.

Customer specific two-shot moulded keycaps on request.

Printing

Keycaps can be printed with a two-component ink on request. The abrasion of this kind of legending is high. This method of legending is suitable for average volumes.

Engraving

In this labour intensive process the keycaps are engraved with the required symbol, then inlaid with ink. Only used for small volumes.

Laser-printing

This method of legending can be recommended when complete keyboards are required in different keyboard layouts for which Rafi will develop the respective software. The keyboards can then be legended within a short time. This method of legending is particularly recommended for average to large volumes.

Legend inserts

In the case of keycaps with replaceable legend inserts it is possible to print or engrave the legend inserts. As these insets are protected by the lens, there can be no abrasion here either.

Design

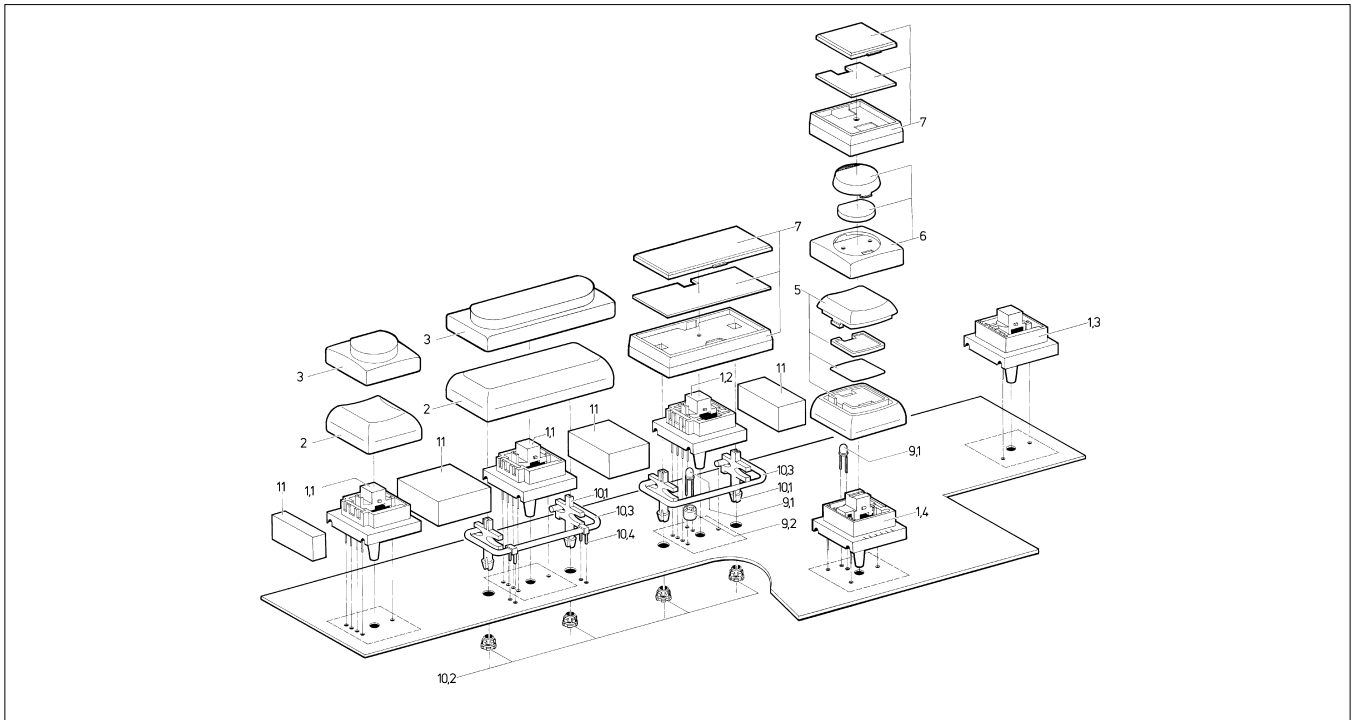

No. Description

- 1.1 Keyswitch RS 76 C
- 1.2 Keyswitch RS 76 C with LED
- 1.3 Keyswitch RS 76 M
- 1.4 Keyswitch R 76 M with LED
- 2 Keycap, 1- resp. multi-module
- 3 Keycap with nail protection, 1- resp. multi-module
- 5 Keycap, illuminated
- 6 Keycap, illuminated
- 7 Keycap, illuminated
- 8 LED

- 9 Spacer for LED (for RS 76 C only)
- 10.1 Plunger for multi-moduel keycaps*
- 10.2 Sleeve for multi-moduel keycaps*
- 10.3 Metal lever for multi-module keycaps*
- 10.4 Bearing bracket for multi-module keycaps*
- 11 Covers

* These parts are included as a complete packet in the delivery of keycaps ≥ 2 -module.

Hole Pattern PCB RS 76 M/RS 76 C

The hole patterns apply to the horizontal position of the keycaps only. Should they be in a vertical position,

the momentary keyswitch must be mounted accordingly, i.e. rotated by 90°.

For 1 – 1³/₄-module keycaps (view on component side)

	Momentary keyswitch, non-illuminated	Momentary keyswitch, illuminated
RS 76 M		
RS 76 C		

4

For 2-, 3- and 8-module keycaps (view on component side)

RS 76 M/C	<p>• 4 holes for bearing bracket diam. 1.1 No through-plating</p>
-----------	---

Keycap	L 1 mm	L 2 mm
2-module	25.40	22.86
3-module	30.48	24.13
5-module	68.58	68.58

Important note: In the case of 2-, 3- and 8-module keycaps, additional holes must be provided for the accessories.
In the case of keycaps < 2-module, neither accessories nor holes are required.

Specific Technical Data RS 76 C

Output pulse diagram Dynamic characteristics (max.)		$T_w = 25\text{ }^\circ\text{C}$	$T_w = 50\text{ }^\circ\text{C}$	$T_w = 70\text{ }^\circ\text{C}$
Turn-on delay time	t_{PHL}	3 μs	7 μs	10 μs
Turn-off delay time	t_{PHL}	4 μs	5 μs	6 μs
Fall/rise time	t_{PHL}	2 μs	2,5 μs	3 μs
	t_{PHL}	1 μs	1,5 μs	2,5 μs

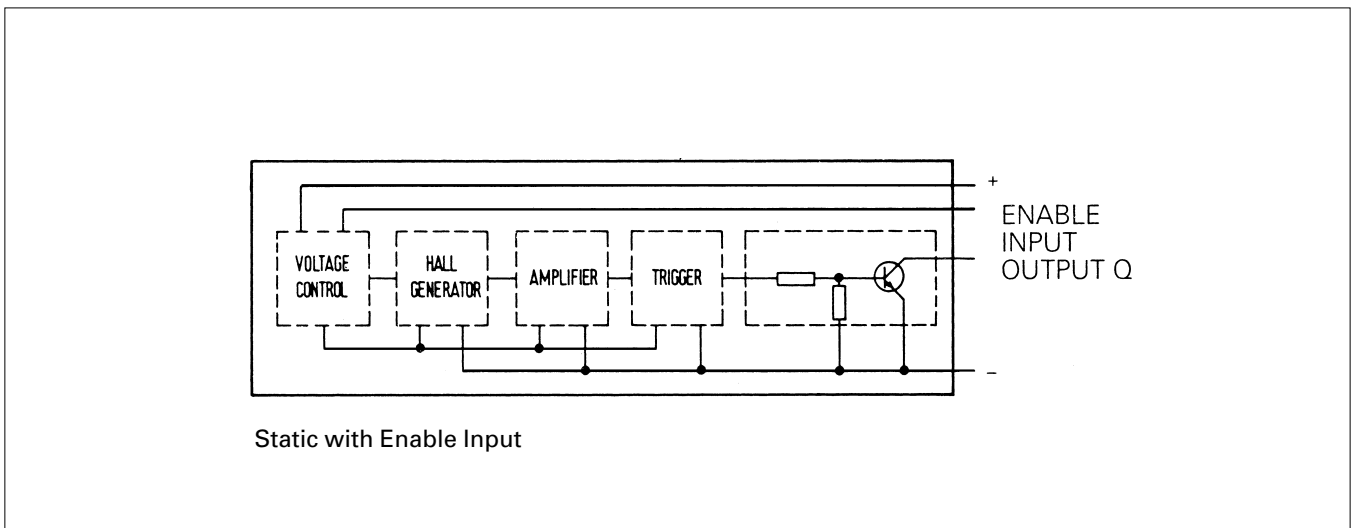
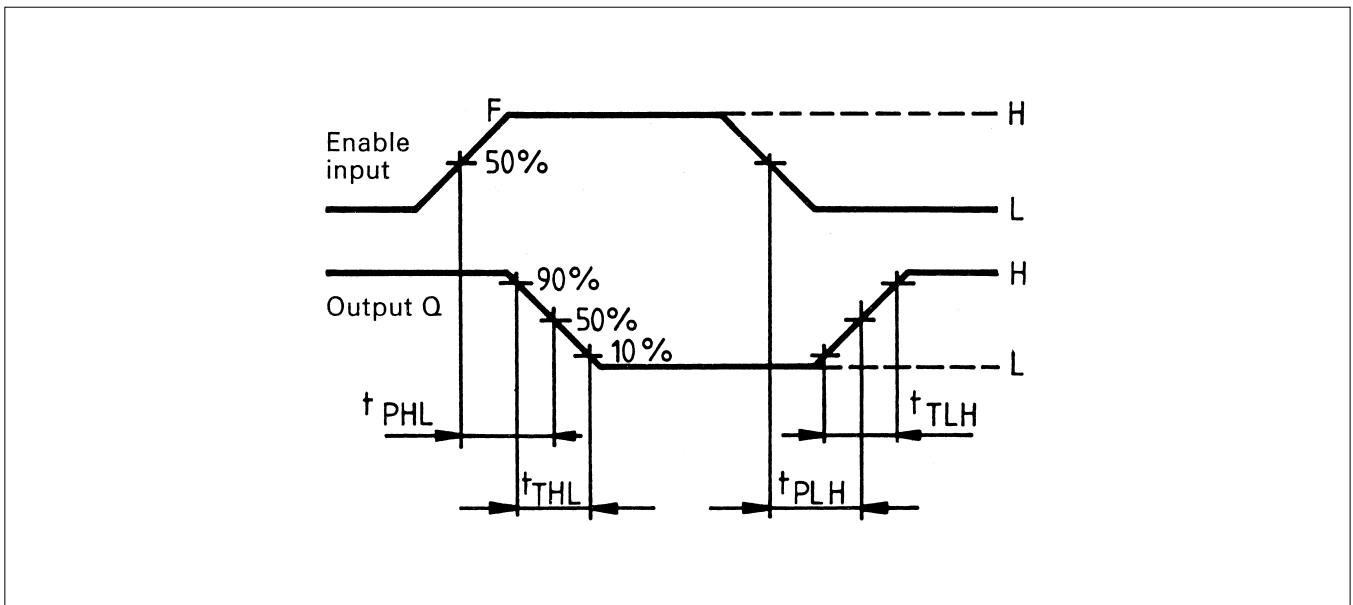

Examples for Application RS 76 C

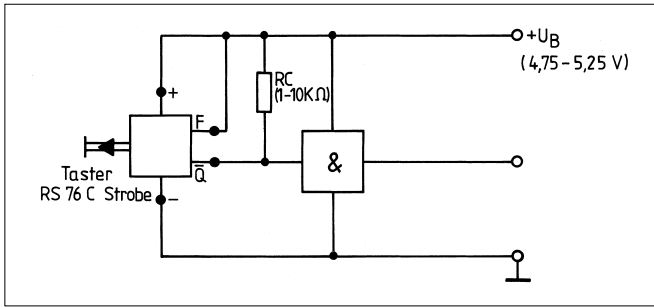

Driving of logic components

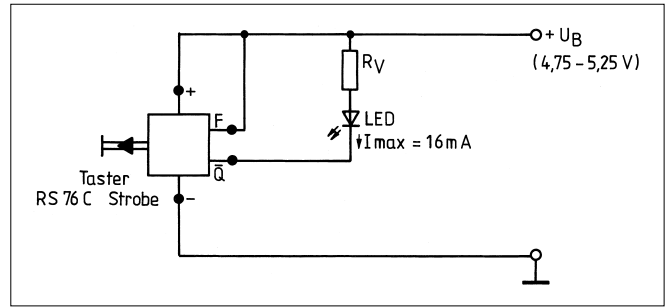

Indication of logical states

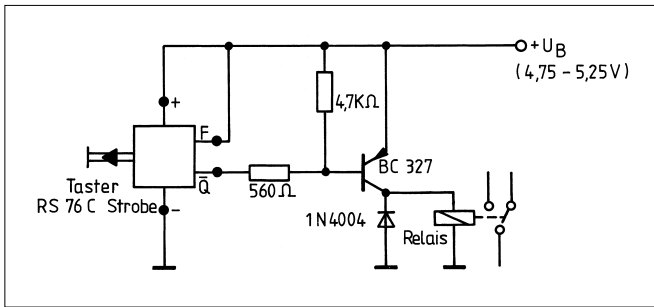

Driving of a PNP transistor

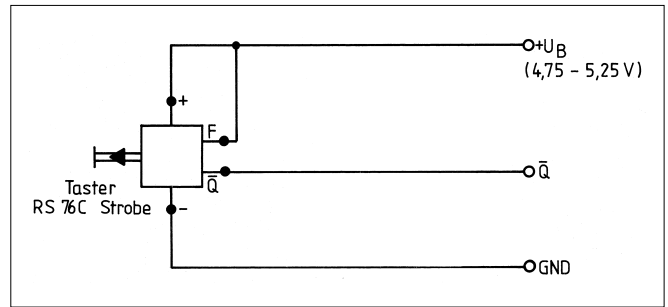

Use as static key with open collector output.
Output transistor (NPN) is conductive when actuated.

4

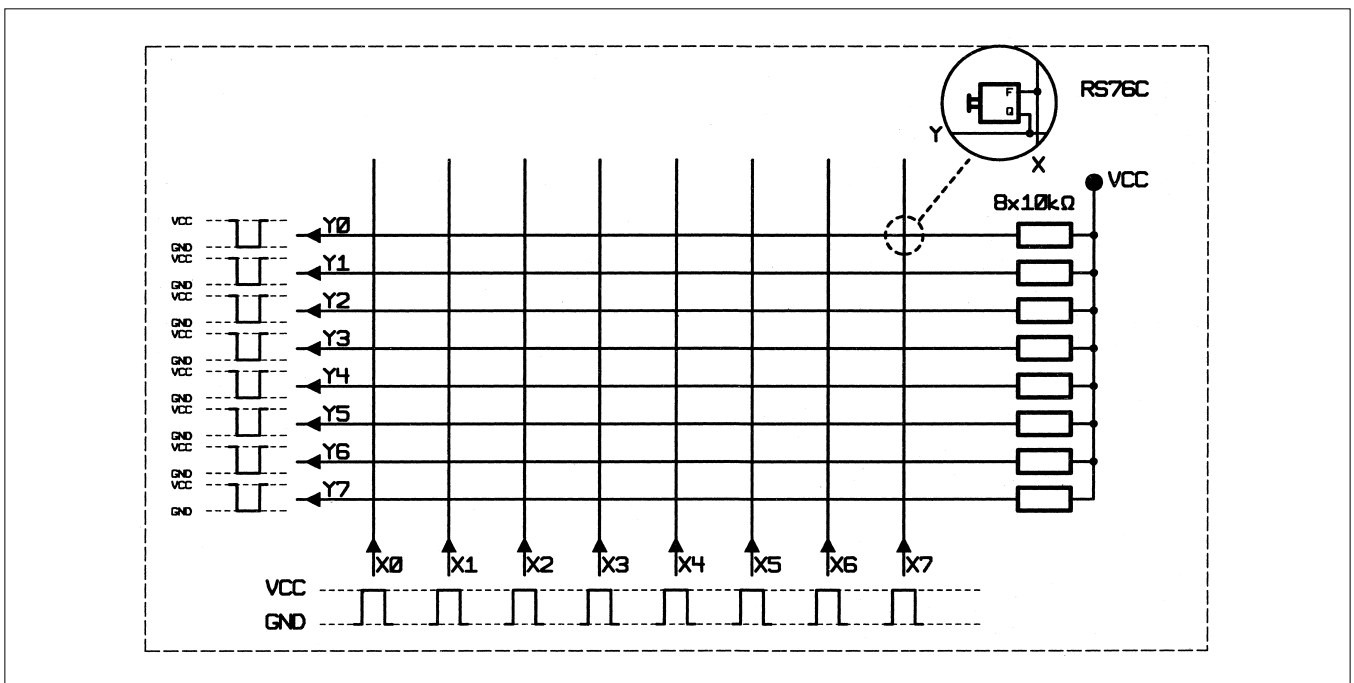

Use in keyboards

RS 76 M full-travel keyswitch, non-illuminated



Technical data

General information

Recommended key grid 19.05 mm

Mechanical design

Contact function momentary
 Mounting soldering
 Terminals solder terminals, tin-plated
 Contact system cross contact
 Contact arrangement 1 NO
 Contact materials Au alloy
 Illumination no

Mechanical characteristics

Operating force max. see order block
 Operating travel 4 mm
 Switching travel 1.5 - 2.8 mm
 Robustness min. 100 N

Electrical characteristics

Rated voltage min. 2 V (with Diode 3 V)
 Rated voltage max. 42 V
 Rated current min. 0.01 mA
 Rated current max. 100 mA
 Rated power max. 1 W
 Contact resistance when new max. 100 mΩ (without Diode)
 Contact resistance acc. to life max. 3 Ω (without Diode)
 Insulation resistance 10⁹ Ω
 ESD strength max. 8 kV
 Bouncing time max. 5 ms

Other specifications

Ambient temp. operating min. -25 °C
 Ambient temp. operating max. +70 °C
 Storage temperature min. -40 °C
 Storage temperature max. (product) +80 °C
 Storage temperature max. (rail) +50 °C
 Resistance to constant environment according to IEC 600 68-2-3 and 2-30
 Resistance at variable environment according to IEC 600 68-2-14 and 2-33
 Operating life min. 10⁷
 Degree of protection IP40
 Flammability of materials UL 94 HB

4

Accessories RS 76 M full-travel keyswitch, non-illuminated

Description	Photo	Order no.	Page
Keycap for RS 76 with legend insert		5.04.665.222/5520	4 - 137
Keycap for RS 76, opaque, with nail protection		5.80.000.000/0710	4 - 137
Keycap for RS 76, opaque		5.82.000.000/0152	4 - 136

RS 76

RS 76 full-travel keyswitches

RS 76 M keyswitch, non-illuminated

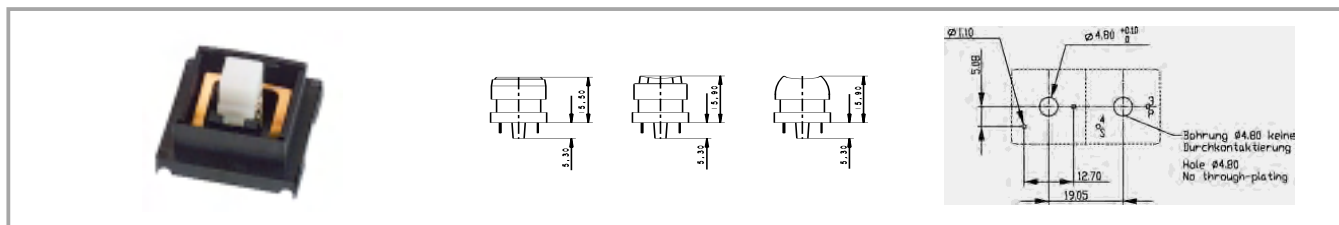

Contact function	Illumination	Contact arrangement	Contact materials	Operating travel	Operating force max.	Order no. complete
momentary	no	1 NO	Au alloy	4 mm	0.9 N	3.13.002.502/0000
momentary	no	1 NO	Au alloy	4 mm	1.4 N	3.13.002.512/0000

Technical data see page 4 - 126

For accessories, refer to RS 76 special accessories.
For keycaps, see keycaps for RS 76.

RS 76 M keyswitch with diode, non-illuminated

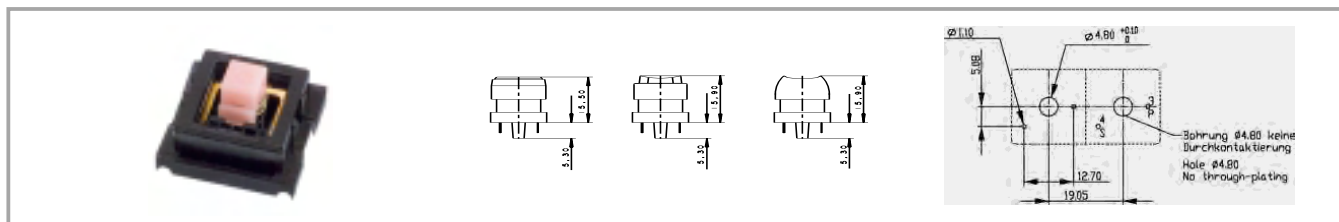

Contact function	Illumination	Contact arrangement	Contact materials	Operating travel	Operating force max.	Order no. complete
momentary	no	1 NO	Au alloy	4 mm	0.9 N	3.13.005.001/0000
momentary	no	1 NO	Au alloy	4 mm	1.4 N	3.13.005.011/0000

Technical data see page 4 - 126

For accessories, refer to RS 76 special accessories.
For keycaps, see keycaps for RS 76.

RS 76 M keyswitch, illuminated



Pict.: RS 76M, for spot illumination

RS 76MX, for full illumination

RS 76MX, keyboard fully illuminated

Technical data

General information

Recommended key grid 19.05 mm

Mechanical design

Contact function see order block
 Mounting soldering
 Terminals solder terminals, tin-plated
 Contact system bridge contact
 Contact arrangement 1 NO
 Contact materials Au alloy
 Illumination see order block

Mechanical characteristics

Operating force max. 1 N
 Operating travel 4 mm
 Switching travel 1.5 - 2.8 mm
 Robustness min. 100 N

Electrical characteristics

Rated voltage min. 2 V
 Rated voltage max. 42 V
 Rated current min. 0.01 mA
 Rated current max. 100 mA
 Rated power max. 1 W
 Contact resistance when new max. 200 mΩ

Contact resistance acc. to life max. 3 Ω
 Insulation resistance 10⁹ Ω
 ESD strength max. 8 kV
 Bouncing time max. 10 ms

Other specifications

Ambient temp. operating min. -25 °C
 Ambient temp. operating max. +70 °C
 Storage temperature min. -40 °C
 Storage temperature max. (product) +80 °C
 Storage temperature max. (rail) +50 °C
 Resistance to constant environment according to IEC 600 68-2-3 and 2-30
 Resistance at variable environment according to IEC 600 68-2-14 and 2-33
 Operating life min. 10⁷ momentary, 10⁵ latching
 Degree of protection IP40
 Flammability of materials UL 94 HB

4

Accessories RS 76 M keyswitch, illuminated

Description	Photo	Order no.	Page
LED yellow, 3mm		1.90.690.103/0000	5 - 21
Cover for RS 76 IP40, 1-module, dark grey		5.04.520.174/0801	4 - 145
Keycap for RS 76, illuminated, with legend insert		5.04.665.522/5520	4 - 139
Keycap for RS 76, illuminated, with nail protection and legend insert		5.04.665.912/5520	4 - 139
Keycap for RS 76 with light bar		5.82.110.000/0710	4 - 138

RS
76

RS 76 full-travel keyswitches

RS 76 M keyswitch, illuminated, momentary

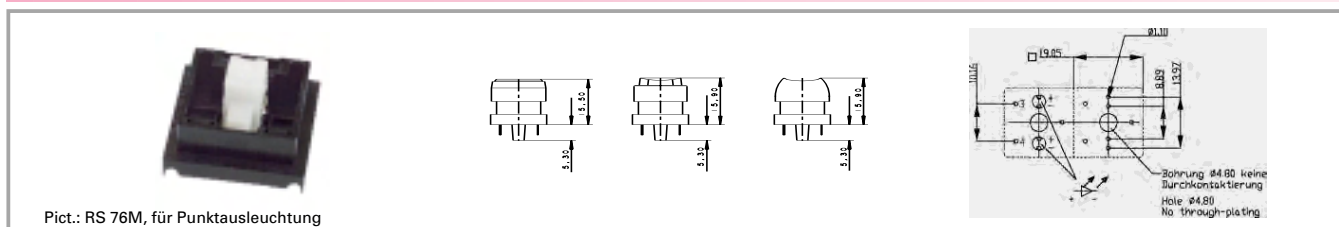

Pict.: RS 76M, für Punktausleuchtung

Contact function	Contact system	Illumination	Recommended key grid	Order no. complete
momentary	bridge contact	spot illumination with 3 mm LED possible	19.05 mm	3.13.002.102/0000

Technical data see page 4 - 128

For accessories, refer to RS 76 special accessories.

For keycaps, see keycaps for RS 76.

RS 76 M keyswitch, illuminated, latching

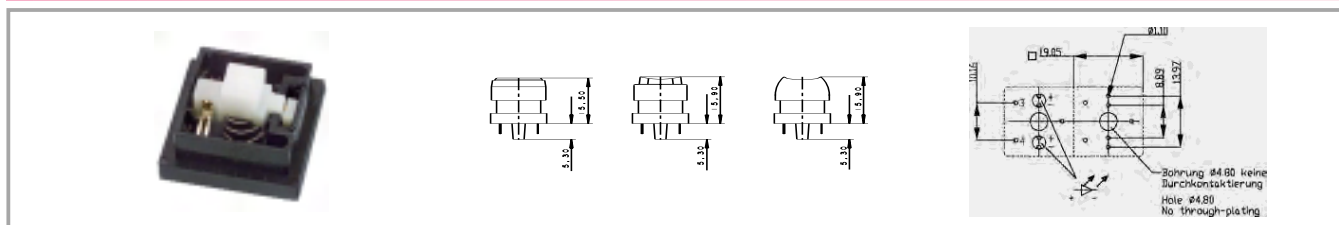

Contact function	Contact system	Illumination	Recommended key grid	Order no. complete
latching	bridge contact	spot illumination with 3 mm LED possible	19.05 mm	3.13.002.022/0000

Technical data see page 4 - 128

For accessories, refer to RS 76 special accessories.

For keycaps, see keycaps for RS 76.

RS 76 MX keyswitch, fully illuminated

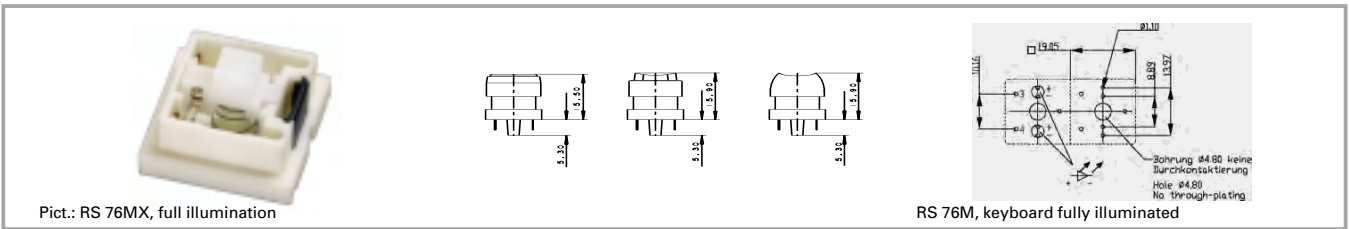

Contact function	Contact system	Illumination	Recommended key grid	Order no. complete
momentary	bridge contact	full illumination with 2 SMD LED possible	19.05 mm	3.13.002.922/0000

Technical data see page 4 - 128

Accessories:

Keycap, fully illuminated, for RS 76 MX: 5.05.511.168/0209
 Keycap, fully illuminated, for RS 76 MX: 5.05.511.168/0754

For accessories, refer to RS 76 special accessories.

For keycaps, see keycaps for RS 76.

The SMD LEDs are soldered on the back of the printed circuit board and shine through openings in the board and keyswitch housing.

RS 76 C keyswitch, non-illuminated

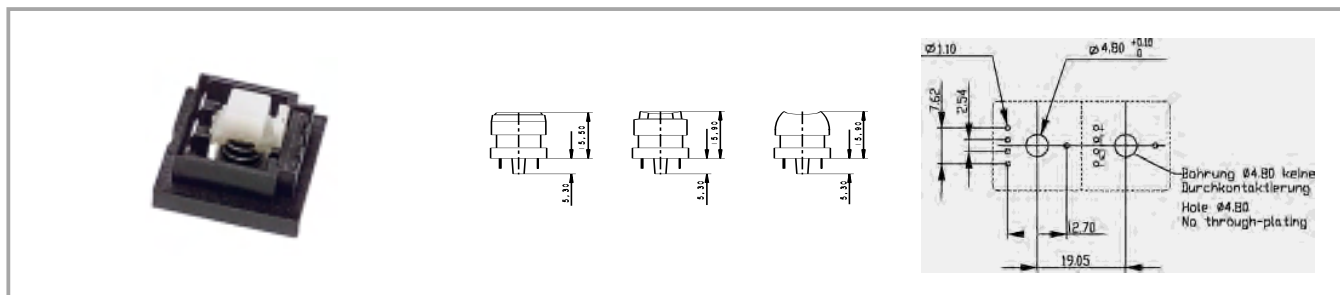

Technical data

General information

Recommended key grid 19.05 mm

Mechanical design

Contact function momentary
 Mounting soldering
 Terminals solder terminals, tin-plated
 Contact system contactless with Hall-IC
 Illumination no

Mechanical characteristics

Switching travel off 0.8 ... 2.4 mm
 Operating force max. see order block
 Operating travel 4 mm
 Switching travel on 1.5 - 2.8 mm
 Robustness min. 100 N

Electrical characteristics

Operating voltage DC 4.75 ... 5.25 V
 Supply current max. at $U_{IL} = 0 V$ 0.5 mA
 Supply current max. at $U_{IH} = 5 V$ 5 mA
 Input voltage (F) at $U_{IL} = 0 V$ 0.4 V
 Input voltage (F) at $U_{IH} = 2.4 V$ 5.25 V
 Output load current (Q) max. 16 mA
 Output residual current (Q) max. 10 μA
 Output saturation

voltage (Q) max. bei 16 mA 0.4 V
 ESD strength max. 8 kV
 Output switching times (Q) bei 25°C, t_{PHL} 3 μs
 Output switching times (Q) bei 25°C, t_{PLH} 4 μs
 Output switching times (Q) bei 25°C, t_{THL} 1 μs
 Output switching times (Q) bei 25°C, t_{TLH} 2 μs

Other specifications

Reliability of Hall-IC's at 25°C $\lambda = 2.5 \times 10^{-7} h^{-1}$
 Ambient temp. operating min. 0 °C
 Ambient temp. operating max. +70 °C
 Storage temperature min. -40 °C
 Storage temperature max. (product) +80 °C
 Storage temperature max. (rail) +50 °C
 Resistance to constant environment according to IEC 600 68-2-3 and 2-30
 Resistance at variable environment according to IEC 600 68-2-14 and 2-33
 Operating life min.(mechanical) see order block
 Degree of protection IP40
 Flammability of materials UL 94 HB

Accessories RS 76 C keyswitch, non-illuminated

Description	Photo	Order no.	Page
Keycap for RS 76 with legend insert		5.04.665.222/5520	4 - 137
Keycap for RS 76, opaque, with nail protection		5.80.000.000/0710	4 - 137
Keycap for RS 76, opaque		5.82.000.000/0152	4 - 136

RS 76 full-travel keyswitches

RS 76 C keyswitch, non-illuminated

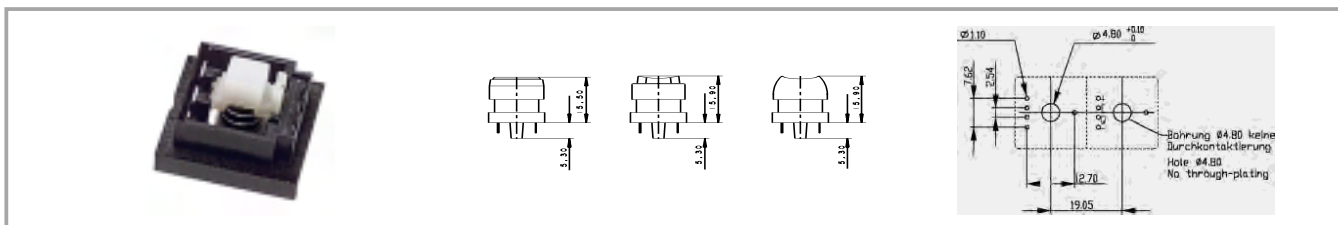

Contact function	Contact system	Illumination	Operating force max.	Operating travel	Order no. complete
momentary	contactless with Hall-IC	no	0.7 N	4 mm	3.13.001.010/0000
momentary	contactless with Hall-IC	no	1 N	4 mm	3.13.001.210/0000

Technical data see page 4 - 132

For accessories and keycaps, refer to RS 76. For applications, refer to the general description of RS 76.

RS 76 C keyswitch, illuminated

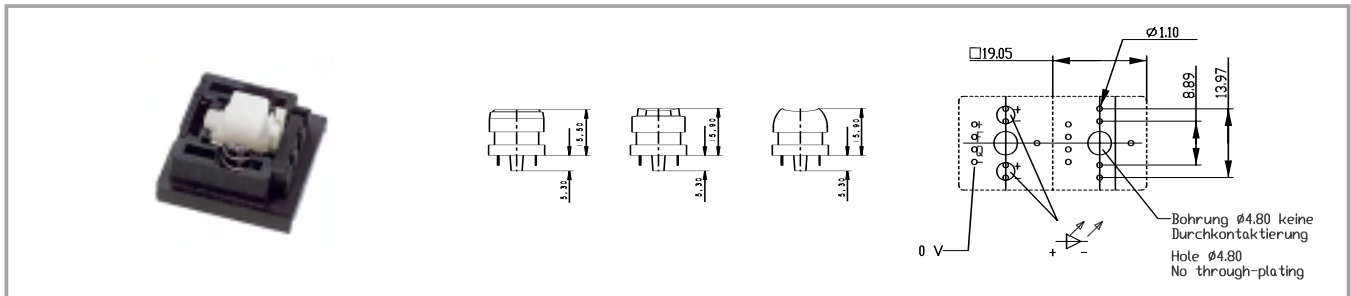

Technical data

General information

Recommended key grid 19.05 mm

Mechanical design

Contact function see order block
 Mounting soldering
 Terminals solder terminals, tin-plated
 Contact system contactless with Hall-IC
 Illumination with LED
 LED colour see order block

Output saturation voltage (Q) max. bei 16 mA 0.4 V
 ESD strength max. 8 kV
 Output switching times (Q) bei 25°C, t_{PHL} 3 μ s
 Output switching times (Q) bei 25°C, t_{PLH} 4 μ s
 Output switching times (Q) bei 25°C, t_{THL} 1 μ s
 Output switching times (Q) bei 25°C, t_{TLH} 2 μ s

Mechanical characteristics

Switching travel on 1.5 - 2.8 mm
 Switching travel off 0.8 ... 2.4 mm
 Operating force max. 0.7 N
 Operating travel 4 mm
 Robustness min. 100 N

Other specifications

Reliability of Hall-IC's at 25°C $\lambda = 2.5 \times 10^{-7} \text{ h}^{-1}$
 Ambient temp. operating min. 0 °C
 Ambient temp. operating max. +70 °C
 Storage temperature min. -40 °C
 Storage temperature max. (product) +80 °C
 Storage temperature max. (rail) +50 °C
 Resistance to constant environment according to IEC 600 68-2-3 and 2-30
 Resistance at variable environment according to IEC 600 68-2-14 and 2-33
 Operating life min. see order block
 Degree of protection IP40
 Flammability of materials UL 94 HB

Electrical characteristics

Number of LED see order block
 Operating voltage DC 4.75 ... 5.25 V
 Supply current max. at $U_{IL} = 0 \text{ V}$ 0.5 mA
 Supply current max. at $U_{IH} = 5 \text{ V}$ 5 mA
 Input voltage (F) at $U_{IL} = 0 \text{ V}$ 0.4 V
 Input voltage (F) at $U_{IH} = 2.4 \text{ V}$ 5.25 V
 Output load current (Q) max. 16 mA
 Output residual current (Q) max. 10 μ A

Accessories RS 76 C keyswitch, illuminated

Description	Photo	Order no.	Page
LED yellow, 3mm		1.90.690.103/0000	5 - 21
Cover for RS 76 IP40, 1-module, dark grey		5.04.520.174/0801	4 - 145

RS 76 full-travel keyswitches

Accessories RS 76 C keyswitch, illuminated

Description	Photo	Order no.	Page
Keycap for RS 76, illuminated, with legend insert		5.04.665.522/5520	4 - 139
Keycap for RS 76, illuminated, with nail protection and legend insert		5.04.665.912/5520	4 - 139
Keycap for RS 76 with light bar		5.82.110.000/0710	4 - 138

RS 76 C keyswitch, illuminated, momentary

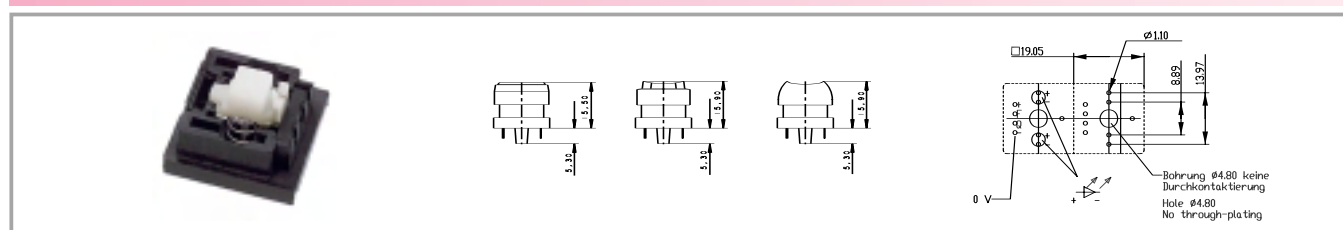

Contact function	Contact system	Illumination	Operating force max.	Operating travel	Order no. complete
momentary	contactless with Hall-IC	with LED	0.7 N	4 mm	3.13.001.110/0000

Technical data see page 4 - 134

RS 76 C keyswitch, illuminated, latching

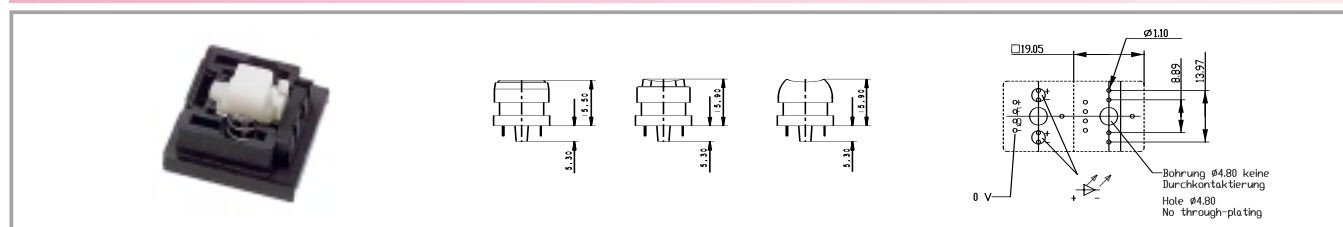

Contact function	Contact system	Illumination	Operating force max.	Operating travel	Order no. complete
latching	contactless with Hall-IC	with LED	0.7 N	4 mm	3.13.001.130/0000

Technical data see page 4 - 134

Keycaps for RS 76, non-illuminated



Keycap for RS 76, opaque



Size of keycap	Illuminable	Colour of keycap / legending	Colour of lens / legend insert	Order no. complete
1-module	no	light beige/-		5.82.000.000/0710
1-module	no	light grey/-		5.82.000.000/0242
1-module	no	dark grey/-		5.82.000.000/0801
1-module	no	charcoal grey/-		5.82.000.000/0152

Keycap sets available in two-shot moulded design.

Other keycap sizes, e.g. 1.25-, 1.5-, 1.75-, 2-, 3-, 5- and 8-module versions available on request.

4

RS 76 full-travel keyswitches

Keycap for RS 76, opaque, with nail protection



Size of keycap	Illuminable	Colour of keycap / legending	Colour of lens / legend insert	Order no. complete
1-module	no	light beige/-		5.80.000.000/0710
1-module	no	light grey/-		5.80.000.000/0242
1-module	no	dark grey/-		5.80.000.000/0801
1-module	no	charcoal grey/-		5.80.000.000/0152

Keycap sets available in two-shot moulded design.

Other keycap sizes, e.g. 1.25-, 1.5-, 1.75-, 2-, 3- and 8-module versions available on request.

Keycap for RS 76 with legend insert



Size of keycap	Illuminable	Colour of keycap / legending	Colour of lens / legend insert	Order no. complete
1-module	no	light beige/-	colourless/white	5.04.665.222/5520
1-module	no	dark grey/-	colourless/white	5.04.665.228/5520
1-module	no	charcoal grey/-	colourless/white	5.04.665.221/5520
1-module	no	light grey/-	colourless/white	5.04.665.230/5520

Supplied as single parts: Mat lens, legend insert, keycap body.

Keycaps for RS 76, illuminated



Pict.: 1,5-module, light grey, green lens



light beige

Keycap for RS 76 with light bar



Pict.: light beige

Size of keycap	Illuminable	Colour of keycap / legending	Colour of lens / legend insert	Order no. complete
1-module	yes	light beige/-		5.82.110.000/0710
1-module	yes	light grey/-		5.82.110.000/0242
1-module	yes	dark grey/-		5.82.110.000/0801
1-module	yes	charcoal grey/-		5.82.110.000/0152

4

RS 76 full-travel keyswitches

Keycap for RS 76, illuminated, with legend insert



Pict.: 1,5-module, light grey, green lens

Size of keycap	Illuminable	Colour of keycap / legending	Colour of lens / legend insert	Order no. complete
1-module	yes	light beige/-	colourless/white	5.04.665.522/5520
1-module	yes	dark grey/-	colourless/white	5.04.665.528/5520
1-module	yes	charcoal grey/-	colourless/white	5.04.665.521/5520
1-module	yes	light grey/-	colourless/white	5.04.665.530/5520

Supplied as single parts: Mat lens, legend insert, diffuser foil, keycap body.
Other colours on request.

Keycap for RS 76, illuminated, with nail protection and legend insert



Pict.: light grey, yellow lens

Size of keycap	Illuminable	Colour of keycap / legending	Colour of lens / legend insert	Order no. complete
1-module	yes	light beige/-	colourless/white	5.04.665.912/5520
1-module	yes	dark grey/-	colourless/white	5.04.665.918/5520
1-module	yes	charcoal grey/-	colourless/white	5.04.665.911/5520
1-module	yes	light grey/-	colourless/white	5.04.665.920/5520

Supplied as single parts: Mat lens, legend insert, keycap body.
Other colours on request.

Keycap for RS 76, illuminated, with legend insert



Size of keycap	Illuminable	Colour of keycap / legending	Colour of lens / legend insert	Order no. complete
1-module	yes	light beige/-	colourless/white	5.04.665.162/5520
1-module	yes	dark grey/-	colourless/white	5.04.665.168/5520
1-module	yes	charcoal grey/-	colourless/white	5.04.665.161/5520
1-module	yes	light grey/-	colourless/white	5.04.665.170/5520

Supplied as single parts: Mat lens, legend insert, diffuser foil, keycap body.
Other colours on request.

Keycap, fully illuminated, for RS 76 MX

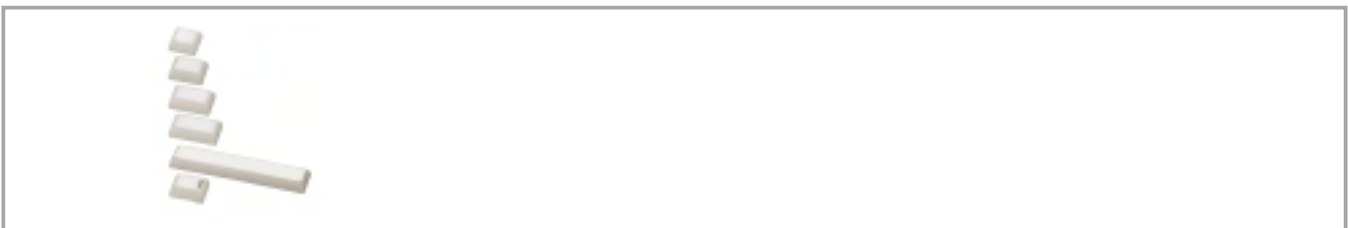

Size of keycap	Illuminable	Colour of keycap / legending	Colour of lens / legend insert	Order no. complete
1-module	yes	white/-	white translucent/-	5.05.511.168/0209
1-module	yes	light grey/-	white translucent/-	5.05.511.168/0754
1 ¹ / ₄ -tlg	yes	white/-	white translucent/-	5.05.511.169/0209
1 ¹ / ₂ -tlg	yes	white/-	white translucent/-	5.05.511.170/0209
1 ³ / ₄ -tlg	yes	white/-	white translucent/-	5.05.511.171/0209
1 ¹ / ₄ -module with light conductor	yes	white/-	white translucent/-	5.05.511.173/0209
5-module	yes	light grey/-	white translucent/-	5.00.888.171/0000

Laser-printed versions available on request.

Keycaps for RS 76, with legend, two-shot moulded/keycap sets



Keycap set for RS 76, symbols A-Z

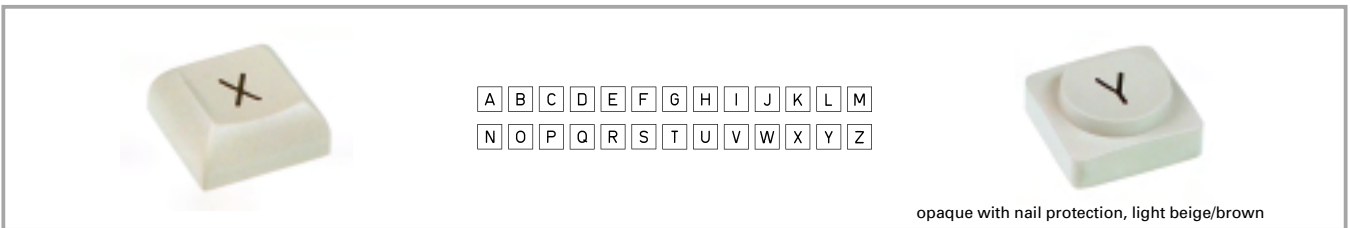

Size of keycap	Form of lens	Colour of keycap / legending	Symbol	Order no. complete
1-module	keycap opaque with nail protection	light beige/brown	A-Z	5.00.999.501/0000
1-module	keycap opaque with nail protection	dark grey/white	A-Z	5.00.999.502/0000
1-module	keycap opaque with nail protection	charcoal grey/white	A-Z	5.00.999.500/0000
1-module	keycap opaque with nail protection	light grey/black	A-Z	5.00.999.824/0000
1-module	keycap opaque	light beige/brown	A-Z	5.00.999.526/0000
1-module	keycap opaque	dark grey/white	A-Z	5.00.999.527/0000
1-module	keycap opaque	charcoal grey/white	A-Z	5.00.999.525/0000
1-module	keycap opaque	light grey/black	A-Z	5.00.999.825/0000

4

RS 76 full-travel keyswitches

Keycap set for RS 76, symbols 0-9

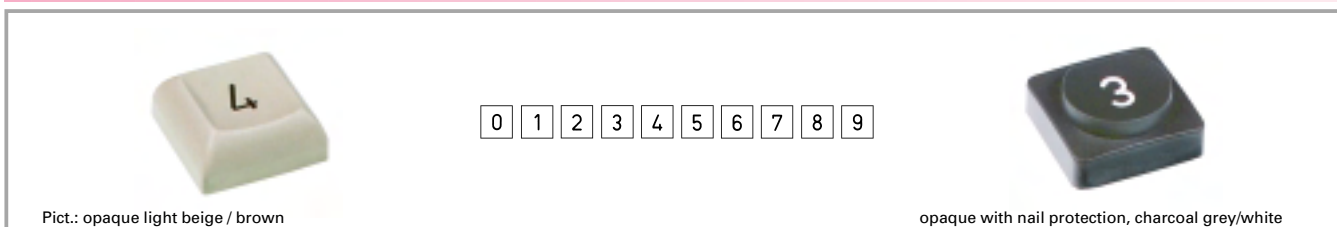

Pict.: opaque light beige / brown

opaque with nail protection, charcoal grey/white

Size of keycap	Form of lens	Colour of keycap / Legending	Symbol	Order no. complete
1-module	keycap opaque with nail protection	light beige/brown	0-9	5.00.999.505/0000
1-module	keycap opaque with nail protection	dark grey/white	0-9	5.00.999.506/0000
1-module	keycap opaque with nail protection	charcoal grey/white	0-9	5.00.999.504/0000
1-module	keycap opaque with nail protection	light grey/black	0-9	5.00.999.826/0000
1-module	keycap opaque	light beige/brown	0-9	5.00.999.530/0000
1-module	keycap opaque	dark grey/white	0-9	5.00.999.531/0000
1-module	keycap opaque	charcoal grey/white	0-9	5.00.999.529/0000
1-module	keycap opaque	light grey/black	0-9	5.00.999.827/0000

RS 76 accessories



Cover for RS 76 IP40

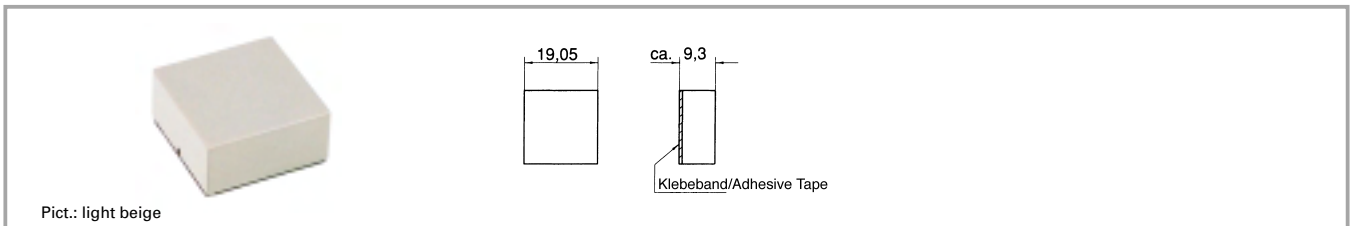

Short text	Feature 1	Feature 2	Order no.
Cover for RS 76 IP40, 1/4-module, black	black	1/4-module	5.04.520.171/0103
Cover for RS 76 IP40, 1/4-module, charcoal grey	charcoal grey	1/4-module	5.04.520.171/0152
Cover for RS 76 IP40, 1/4-module, light grey	light grey	1/4-module	5.04.520.171/0242
Cover for RS 76 IP40, 1/4-module, light beige	light beige	1/4-module	5.04.520.171/0710
Cover for RS 76 IP40, 1/4-module, light grey	light grey	1/4-module	5.04.520.171/0754
Cover for RS 76 IP40, 1/4-module, dark grey	dark grey	1/4-module	5.04.520.171/0801
Cover for RS 76 IP40, 1/2-module, black	black	1/2-module	5.04.520.172/0103
Cover for RS 76 IP40, 1/2-module, charcoal grey	charcoal grey	1/2-module	5.04.520.172/0152
Cover for RS 76 IP40, 1/2-module, light grey	light grey	1/2-module	5.04.520.172/0242
Cover for RS 76 IP40, 1/2-module, light beige	light beige	1/2-module	5.04.520.172/0710
Cover for RS 76 IP40, 1/2-module, light grey	light grey	1/2-module	5.04.520.172/0754
Cover for RS 76 IP40, 1/2-module, dark grey	dark grey	1/2-module	5.04.520.172/0801
Cover for RS 76 IP40, 3/4-module, black	black	3/4-module	5.04.520.173/0103
Cover for RS 76 IP40, 3/4-module, charcoal grey	charcoal grey	3/4-module	5.04.520.173/0152
Cover for RS 76 IP40, 3/4-module, light grey	light grey	3/4-module	5.04.520.173/0242

4

RS
76

RS 76 full-travel keyswitches

Short text	Feature 1	Feature 2	Order no.
Cover for RS 76 IP40, 3/4-module, light beige	light beige	³ / ₄ -module	5.04.520.173/0710
Cover for RS 76 IP40, 3/4-module, light grey	light grey	³ / ₄ -module	5.04.520.173/0754
Cover for RS 76 IP40, 3/4-module, dark grey	dark grey	³ / ₄ -module	5.04.520.173/0801
Cover for RS 76 IP40, 1-module, black	black	1-module	5.04.520.174/0103
Cover for RS 76 IP40, 1-module, charcoal grey	charcoal grey	1-module	5.04.520.174/0152
Cover for RS 76 IP40, 1-module, light grey	light grey	1-module	5.04.520.174/0242
Cover for RS 76 IP40, 1-module, light beige	light beige	1-module	5.04.520.174/0710
Cover for RS 76 IP40, 1-module, light grey	light grey	1-module	5.04.520.174/0754
Cover for RS 76 IP40, 1-module, dark grey	dark grey	1-module	5.04.520.174/0801