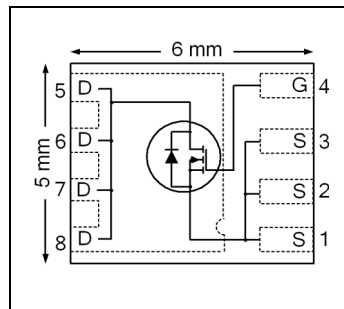


$V_{DSS}$	30	V
$R_{DS(on) max}$ (@ $V_{GS}=10V$ )	4.5	mΩ
$Q_g$ (typical)	16	nC
$I_D$ (@ $T_{c(Bottom)} = 25^\circ C$ )	79 <sup>Ⓞ</sup>	A



### Applications

- Control MOSFET for Buck Converters

### Features and Benefits

#### Features

Low charge (typical 16nC)
Low Thermal Resistance to PCB (<2.7°C/W)
100% Rg Tested
Low Profile (≤ 0.9 mm)
Industry-Standard Pinout
Compatible with Existing Surface Mount Techniques
RoHS Compliant, Halogen-Free
MSL1, Industrial Qualification

#### Benefits

Lower Conduction Losses
Increased Power Density
Increased Reliability
Increased Power Density
Multi-Vendor Compatibility
Easier Manufacturing
Environmentally Friendlier
Increased Reliability

results in  
⇒

Base part number	Package Type	Standard Pack		Orderable Part Number
		Form	Quantity	
IRFH5304PbF	PQFN 5 mm x 6 mm	Tape and Reel	4000	IRFH5304TRPbF

### Absolute Maximum Ratings

	Parameter	Max.	Units
$V_{DS}$	Drain-to-Source Voltage	30	V
$V_{GS}$	Gate-to-Source Voltage	± 20	
$I_D @ T_A = 25^\circ C$	Continuous Drain Current, $V_{GS} @ 10V$	22	A
$I_D @ T_A = 70^\circ C$	Continuous Drain Current, $V_{GS} @ 10V$	17	
$I_D @ T_{c(Bottom)} = 25^\circ C$	Continuous Drain Current, $V_{GS} @ 10V$	79 <sup>Ⓞ</sup>	
$I_D @ T_{c(Bottom)} = 100^\circ C$	Continuous Drain Current, $V_{GS} @ 10V$	50 <sup>Ⓞ</sup>	
$I_{DM}$	Pulsed Drain Current <sup>①</sup>	320	
$P_D @ T_A = 25^\circ C$	Power Dissipation <sup>Ⓞ</sup>	3.6	W
$P_D @ T_{c(Bottom)} = 25^\circ C$	Power Dissipation <sup>Ⓞ</sup>	46	
	Linear Derating Factor <sup>Ⓞ</sup>	0.029	W/°C
$T_J$ $T_{STG}$	Operating Junction and Storage Temperature Range	-55 to + 150	°C

Notes ① through ④ are on page 8

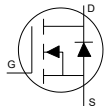
**Static @ T<sub>J</sub> = 25°C (unless otherwise specified)**

	Parameter	Min.	Typ.	Max.	Units	Conditions	
BV <sub>DSS</sub>	Drain-to-Source Breakdown Voltage	30	—	—	V	V <sub>GS</sub> = 0V, I <sub>D</sub> = 250μA	
ΔBV <sub>DSS</sub> /ΔT <sub>J</sub>	Breakdown Voltage Temp. Coefficient	—	0.02	—	V/°C	Reference to 25°C, I <sub>D</sub> = 1.0mA	
R <sub>DS(on)</sub>	Static Drain-to-Source On-Resistance	—	3.8	4.5	mΩ	V <sub>GS</sub> = 10V, I <sub>D</sub> = 47A ②	
		—	5.8	6.8		V <sub>GS</sub> = 4.5V, I <sub>D</sub> = 47A ②	
V <sub>GS(th)</sub>	Gate Threshold Voltage	1.35	1.8	2.35	V	V <sub>DS</sub> = V <sub>GS</sub> , I <sub>D</sub> = 50μA	
ΔV <sub>GS(th)</sub>	Gate Threshold Voltage Coefficient	—	-6.6	—	mV/°C		
I <sub>DSS</sub>	Drain-to-Source Leakage Current	—	—	5.0	μA	V <sub>DS</sub> = 24V, V <sub>GS</sub> = 0V	
		—	—	150		V <sub>DS</sub> = 24V, V <sub>GS</sub> = 0V, T <sub>J</sub> = 125°C	
I <sub>GSS</sub>	Gate-to-Source Forward Leakage	—	—	100	nA	V <sub>GS</sub> = 20 V	
	Gate-to-Source Reverse Leakage	—	—	-100		V <sub>GS</sub> = -20 V	
g <sub>fs</sub>	Forward Transconductance	88	—	—	S	V <sub>DS</sub> = 15 V, I <sub>D</sub> = 47A	
Q <sub>g</sub>	Total Gate Charge	—	41	—		V <sub>GS</sub> = 10V, V <sub>DS</sub> = 15V, I <sub>D</sub> = 49A	
Q <sub>g</sub>	Total Gate Charge	—	16	56	nC	V <sub>DS</sub> = 15V I <sub>D</sub> = 47A V <sub>GS</sub> = 4.5V See Fig.17 & 18	
	Q <sub>gs1</sub>	Pre-V <sub>th</sub> Gate-to-Source Charge	—	3.6			—
	Q <sub>gs2</sub>	Post-V <sub>th</sub> Gate-to-Source Charge	—	2.7			—
	Q <sub>gd</sub>	Gate-to-Drain Charge	—	5.8			—
	Q <sub>godr</sub>	Gate Charge Overdrive	—	3.9			—
Q <sub>sw</sub>	Switch Charge (Q <sub>gs2</sub> + Q <sub>gd</sub> )	—	8.5	—			
Q <sub>oss</sub>	Output Charge	—	9.8	—	nC	V <sub>DS</sub> = 16V, V <sub>GS</sub> = 0V	
R <sub>G</sub>	Gate Resistance	—	1.2	—	Ω		
t <sub>d(on)</sub>	Turn-On Delay Time	—	13	—	ns	V <sub>DD</sub> = 15V, V <sub>GS</sub> = 4.5V I <sub>D</sub> = 47A R <sub>G</sub> = 1.8Ω See Fig.15	
t <sub>r</sub>	Rise Time	—	25	—			
t <sub>d(off)</sub>	Turn-Off Delay Time	—	12	—			
t <sub>f</sub>	Fall Time	—	6.6	—			
C <sub>iss</sub>	Input Capacitance	—	2360	—	pF	V <sub>GS</sub> = 0V V <sub>DS</sub> = 10V f = 1.0MHz	
C <sub>oss</sub>	Output Capacitance	—	510	—			
C <sub>rss</sub>	Reverse Transfer Capacitance	—	220	—			

**Avalanche Characteristics**

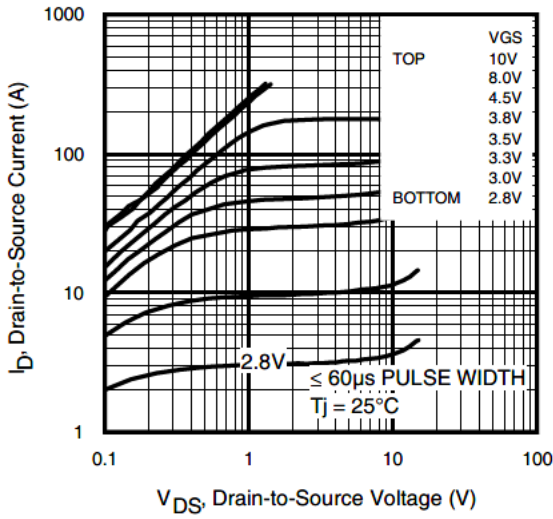
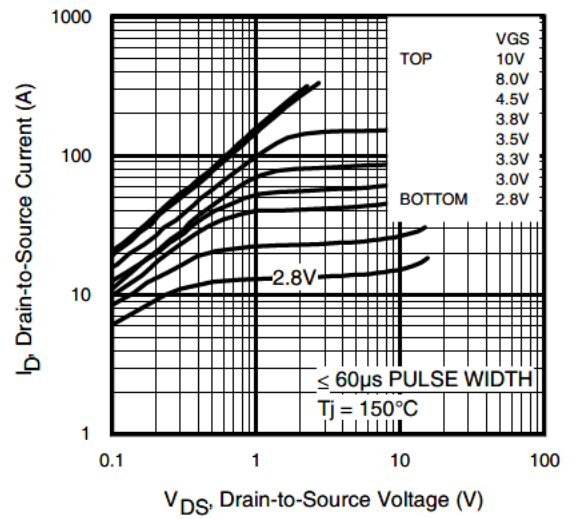
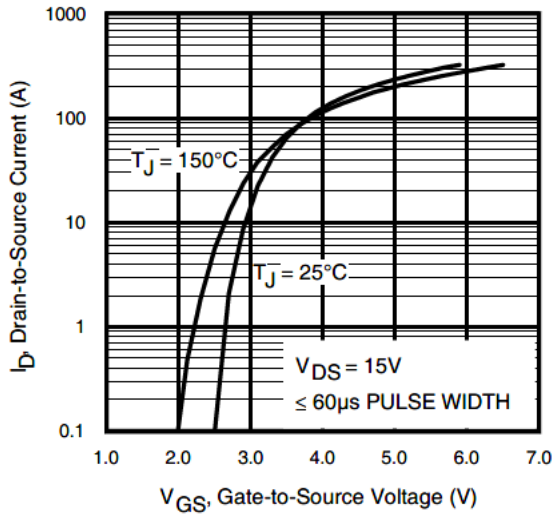
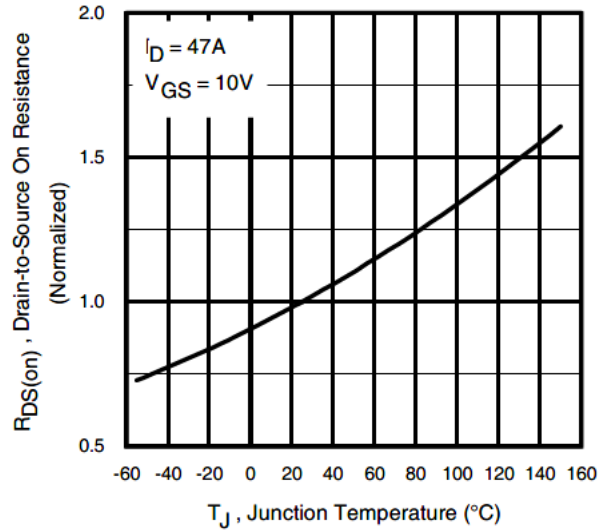
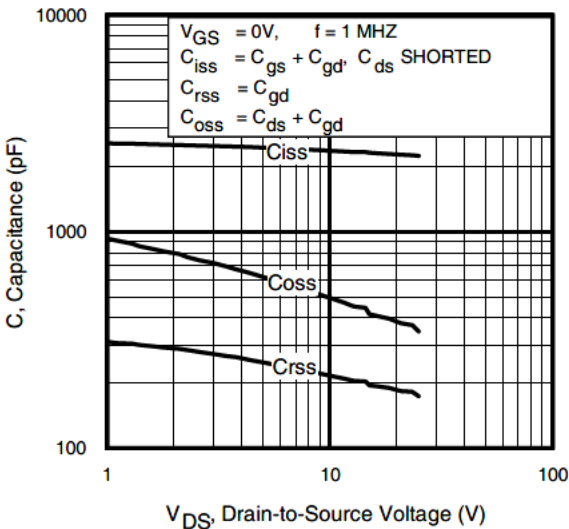
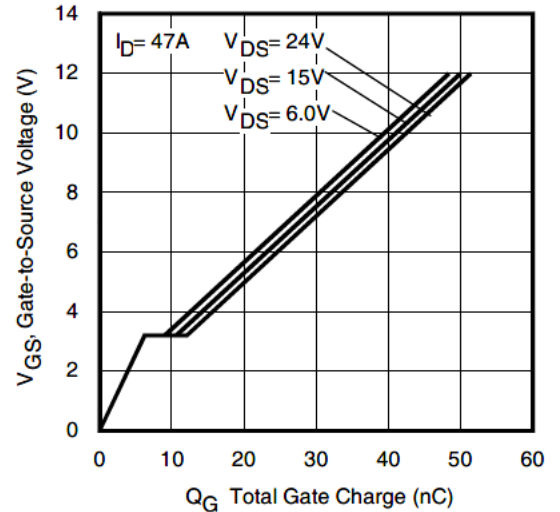
	Parameter	Typ.	Max.	Units
E <sub>AS</sub>	Single Pulse Avalanche Energy ②	—	46	mJ
I <sub>AR</sub>	Avalanche Current①	—	47	A

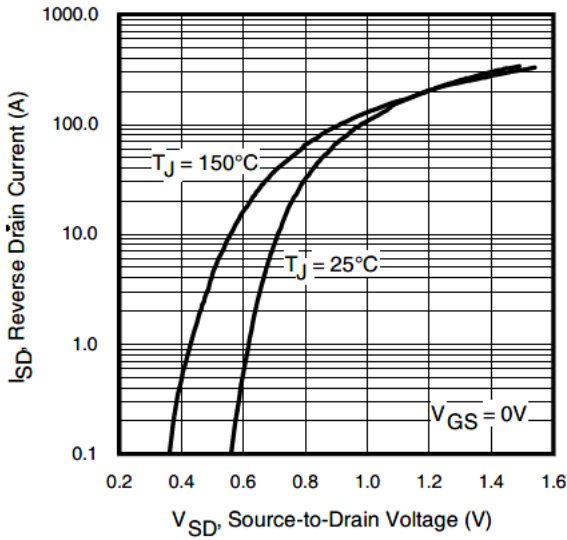
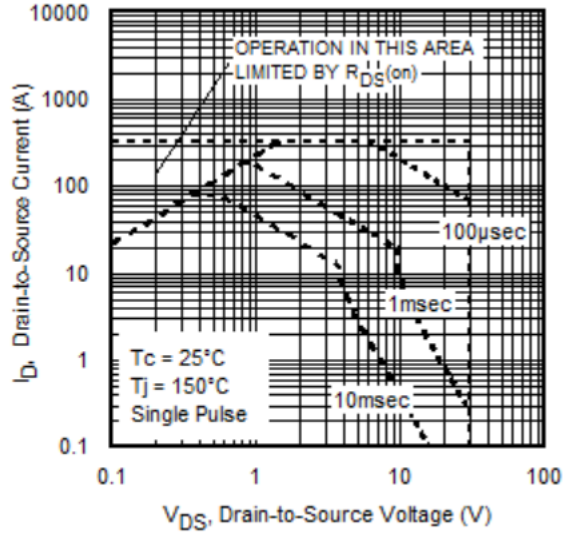
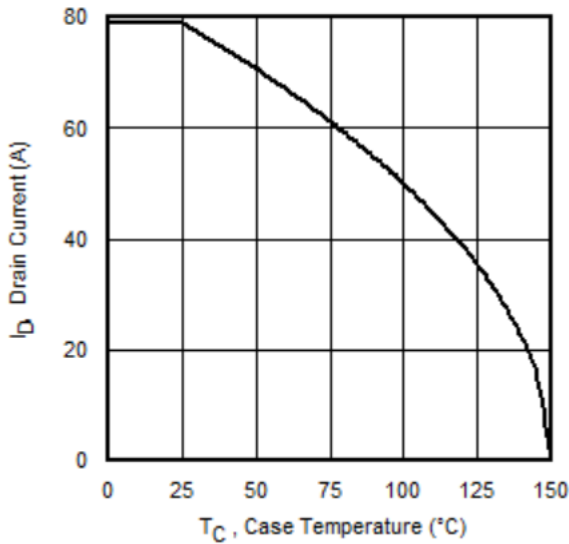
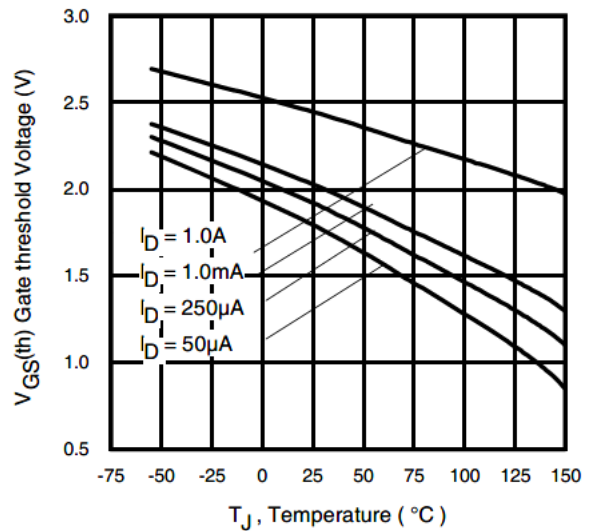
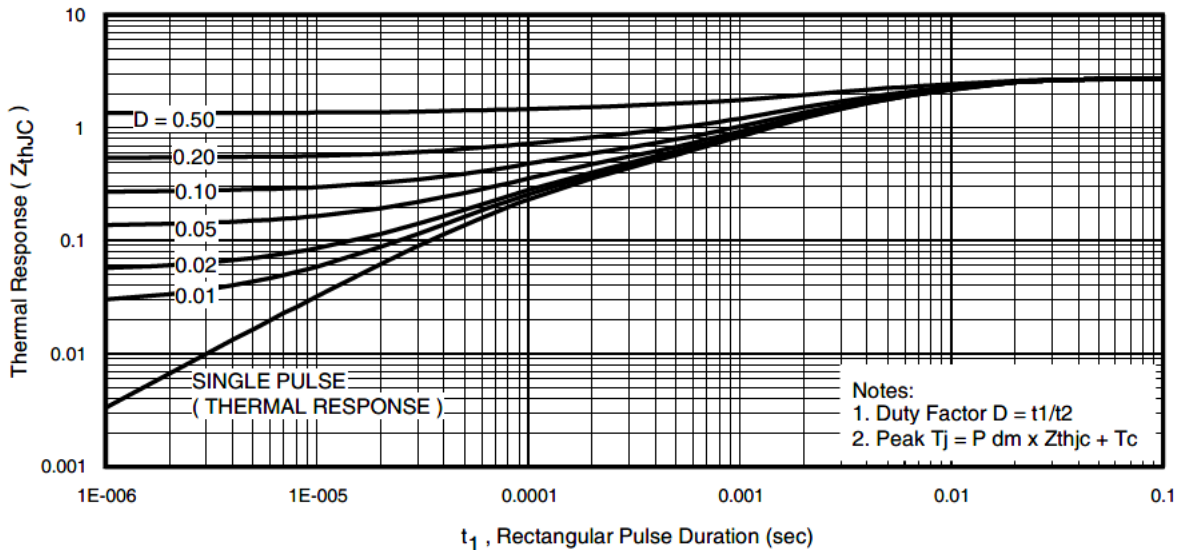
**Diode Characteristics**

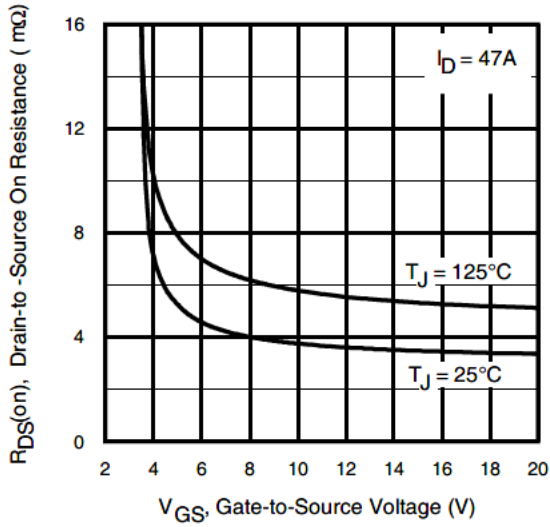
	Parameter	Min.	Typ.	Max.	Units	Conditions
I <sub>S</sub>	Continuous Source Current (Body Diode)	—	—	46	A	MOSFET symbol showing the integral reverse p-n junction diode. 
I <sub>SM</sub>	Pulsed Source Current (Body Diode)	—	—	320①		
V <sub>SD</sub>	Diode Forward Voltage	—	0.71	—		T <sub>J</sub> = 25°C, I <sub>S</sub> = 5A, V <sub>GS</sub> = 0V ③
V <sub>SD</sub>	Diode Forward Voltage	—	—	1.0	V	T <sub>J</sub> = 25°C, I <sub>S</sub> = 47A, V <sub>GS</sub> = 0V ③
t <sub>rr</sub>	Reverse Recovery Time	—	19	29	ns	T <sub>J</sub> = 25°C, I <sub>F</sub> = 47A, V <sub>DD</sub> = 15V
Q <sub>rr</sub>	Reverse Recovery Charge	—	44	66	nC	di/dt = 300A/μs ③
t <sub>on</sub>	Forward Turn-On Time	Time is dominated by parasitic Inductance				

**Thermal Resistance**

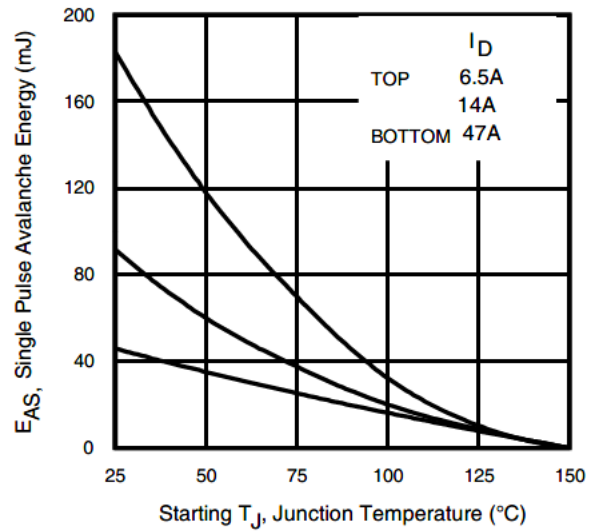
	Parameter	Typ.	Max.	Units
R <sub>θJC</sub> (Bottom)	Junction-to-Mounting Base ④	—	2.7	°C/W
R <sub>θJC</sub> (Top)	Junction-to-Case ④	—	15	
R <sub>θJA</sub>	Junction-to-Ambient ⑤	—	35	
R <sub>θJA</sub> (<10s)	Junction-to-Ambient ⑤	—	22	


**Fig 1.** Typical Output Characteristics

**Fig 2.** Typical Output Characteristics

**Fig 3.** Typical Transfer Characteristics

**Fig 4.** Normalized On-Resistance vs. Temperature

**Fig 5.** Typical Capacitance vs. Drain-to-Source Voltage

**Fig 6.** Typical Gate Charge vs. Gate-to-Source Voltage

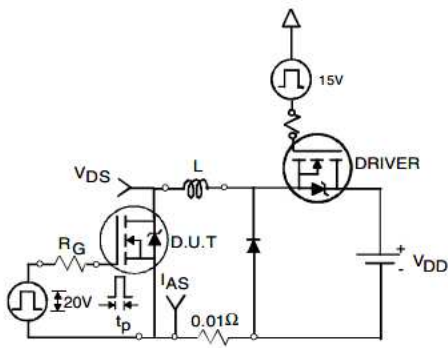

**Fig 7.** Typical Source-Drain Diode Forward Voltage

**Fig 8.** Maximum Safe Operating Area

**Fig 9.** Maximum Drain Current vs. Case Temperature

**Fig 10.** Drain-to-Source Breakdown Voltage

**Fig 11.** Maximum Effective Transient Thermal Impedance, Junction-to-Case



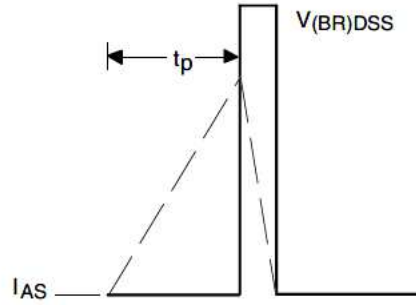
**Fig 12.** On-Resistance vs. Gate Voltage



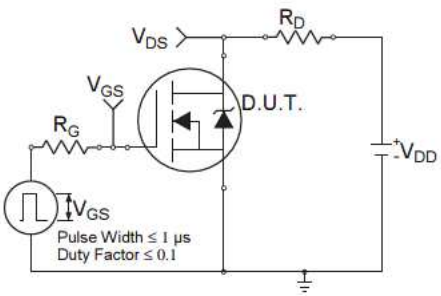
**Fig 13.** Maximum Avalanche Energy vs. Drain Current



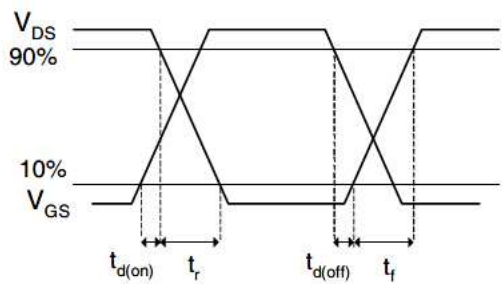
**Fig 14a.** Unclamped Inductive Test Circuit



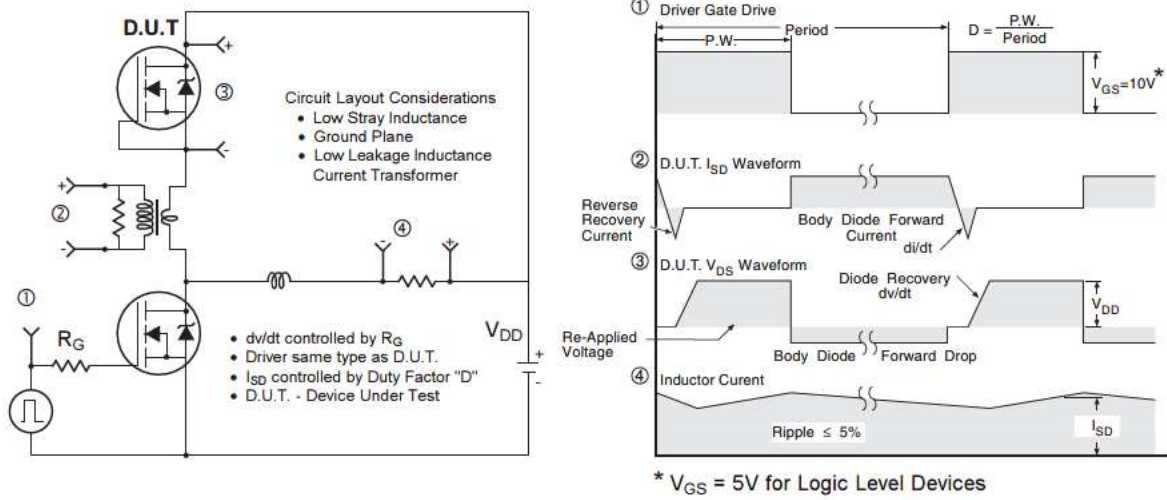
**Fig 14b.** Unclamped Inductive Waveforms



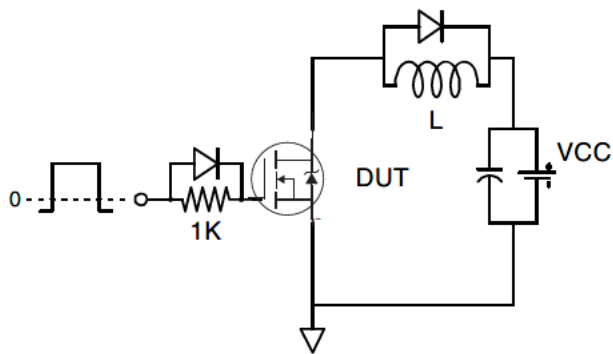
**Fig 15a.** Switching Time Test Circuit



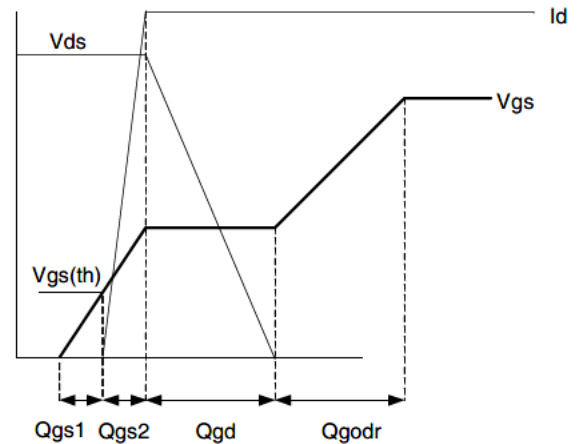
**Fig 15b.** Switching Time Waveforms



**Fig 16. Peak Diode Recovery  $dv/dt$  Test Circuit for N-Channel HEXFET® Power MOSFETs**

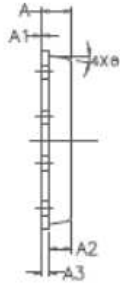


**Fig 17. Gate Charge Test Circuit**

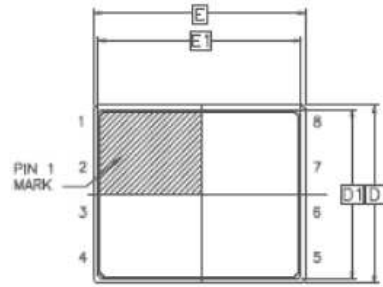


**Fig 18. Gate Charge Waveform**

**PQFN 5x6 Outline "B" Package Details**

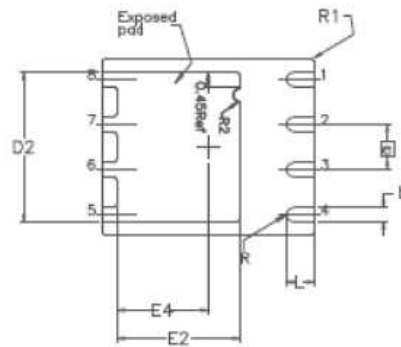


SIDE VIEW



TOP VIEW

SYMBOL	DIM	MIN	NOM	MAX
A		0.800	0.830	1.05
A1		0.000	0.020	0.050
A2		0.580	0.630	0.680
A3			0.254 REF	
Ø		0"	10"	12"
b		0.350	0.400	0.470
D		4.850	5.000	5.150
D1		4.675	4.750	5.000
D2		3.700	4.210	4.300
e			1.270 BSC	
E		5.850	6.000	6.150
E1		5.675	5.750	6.000
E2		3.380	3.480	3.760
F4		2.480	2.580	2.680
L		0.550	0.800	0.900
R			0.200 REF	
R1			0.100 REF	
R2		0.150	0.200	0.250

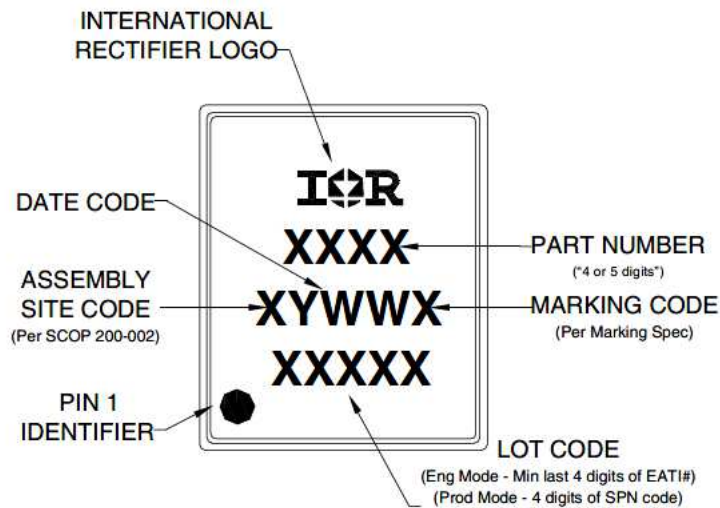


BOTTOM VIEW

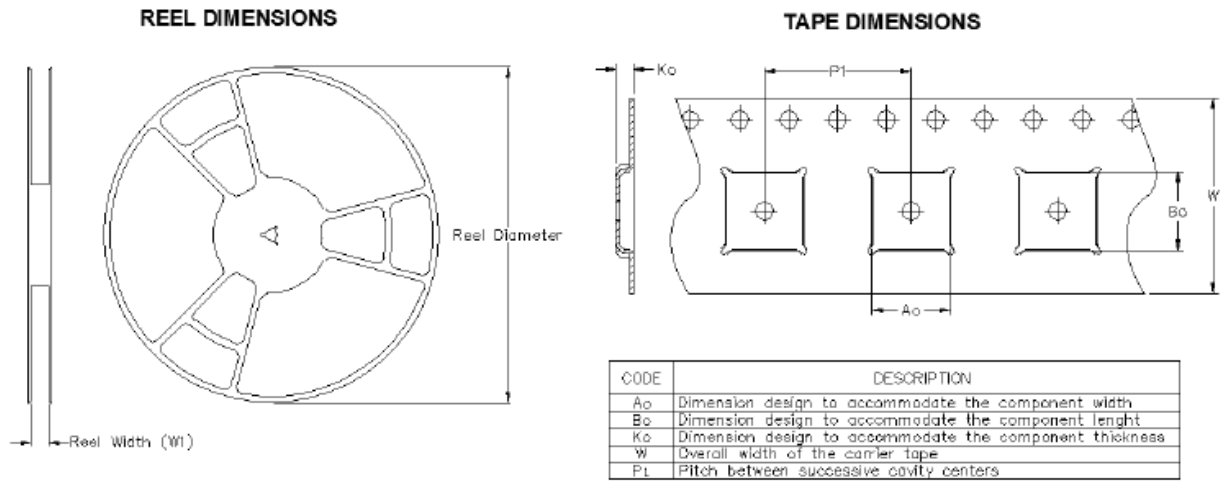
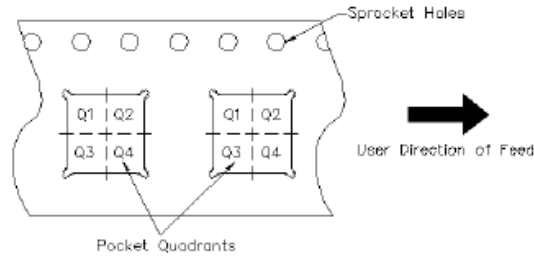
For more information on board mounting, including footprint and stencil recommendation, please refer to application note AN-1136: <http://www.irf.com/technical-info/appnotes/an-1136.pdf>

For more information on package inspection techniques, please refer to application note AN-1154: <http://www.irf.com/technical-info/appnotes/an-1154.pdf>

**PQFN 5x6 Part Marking**



Note: For the most current drawing please refer to IR website at <http://www.irf.com/package/>

**PQFN 5x6 Tape and Reel**

**QUADRANT ASSIGNMENTS FOR PIN 1 ORIENTATION IN TAPE**


*Note : All dimension are in nominal*

Package Type	Reel Diameter (Inch)	QTY	Reel Width W 1 (mm)	A <sub>o</sub> (mm)	B <sub>o</sub> (mm)	K <sub>o</sub> (mm)	P <sub>1</sub> (mm)	W (mm)	Pin 1 Quadrant
5x6 PQFN	13	4000	12.4	6.300	5.300	1.20	8.00	12	Q1

Note: For the most current drawing please refer to IR website at <http://www.irf.com/package/>



**Qualification Information**

<b>Qualification Level</b>	Industrial (per JEDEC JESD47F <sup>†</sup> guidelines)	
<b>Moisture Sensitivity Level</b>	PQFN 5mm x 6mm	MSL1 (per JEDEC J-STD-020D <sup>†</sup> )
<b>RoHS Compliant</b>	Yes	

† Applicable version of JEDEC standard at the time of product release.

**Notes:**

- ① Repetitive rating; pulse width limited by max. junction temperature.
- ② Starting  $T_J = 25^\circ\text{C}$ ,  $L = 0.041\text{mH}$ ,  $R_G = 50\Omega$ ,  $I_{AS} = 47\text{A}$ .
- ③ Pulse width  $\leq 400\mu\text{s}$ ; duty cycle  $\leq 2\%$ .
- ④  $R_\theta$  is measured at  $T_J$  of approximately  $90^\circ\text{C}$ .
- ⑤ When mounted on 1 inch square 2 oz copper pad on 1.5x1.5 in. board of FR-4 material
- ⑥ Rating refers to the product only with datasheet specified absolute maximum values, maintaining case temperature as specified. For other case temperatures please refer to Diagram 9. De-rating will be required based on the actual environmental conditions.

**Revision History**

Date	Rev.	Comments
5/14/2014	2.1	<ul style="list-style-type: none"> <li>• Updated ordering information to reflect the End-of-Life (EOL) of the mini-reel option (EOL notice #259)</li> <li>• Update Package outline on page 7</li> <li>• Updated data sheet based on IR corporate template.</li> </ul>
03/19/2015	2.2	<ul style="list-style-type: none"> <li>• Updated package outline and tape and reel on pages 7 and 8</li> </ul>
03/19/2021	2.3	<ul style="list-style-type: none"> <li>• Updated datasheet based on IFX template.</li> <li>• Updated Datasheet based on new current rating and application note :App-AN_1912_PL51_2001_180356</li> </ul>

**Trademarks of Infineon Technologies AG**

μHVIC™, μIPM™, μPFC™, AU-ConvertIR™, AURIX™, C166™, CanPAK™, CIPOS™, CIPURSE™, CoolDP™, CoolGaN™, COOLiR™, CoolMOS™, CoolSET™, CoolSiC™, DAVE™, DI-POL™, DirectFET™, DrBlade™, EasyPIM™, EconoBRIDGE™, EconoDUAL™, EconoPACK™, EconoPIM™, EiceDRIVER™, eupec™, FCOS™, GaNpowIR™, HEXFET™, HITFET™, HybridPACK™, iMOTION™, IRAM™, ISOFACE™, IsoPACK™, LEDriviR™, LITIX™, MIPAQ™, ModSTACK™, my-d™, NovalithIC™, OPTIGA™, OptiMOS™, ORIGA™, PowIRaudio™, PowIRstage™, PrimePACK™, PrimeSTACK™, PROFET™, PRO-SiL™, RASIC™, REAL3™, SmartLEWIS™, SOLID FLASH™, SPOC™, StrongIRFET™, SupIRBuck™, TEMPFET™, TRENCHSTOP™, TriCore™, UHVIC™, XHP™, XMC™

Trademarks updated November 2015

**Other Trademarks**

All referenced product or service names and trademarks are the property of their respective owners.

**Edition 2016-04-19**

**Published by**

**Infineon Technologies AG**

**81726 Munich, Germany**

**© 2016 Infineon Technologies AG.**

**All Rights Reserved.**

**Do you have a question about this document?**

**Email: [erratum@infineon.com](mailto:erratum@infineon.com)**

**Document reference**

**ifx1**

**IMPORTANT NOTICE**

The information given in this document shall in no event be regarded as a guarantee of conditions or **characteristics** (“**Beschaffheitsgarantie**”).

With respect to any examples, hints or any typical values stated herein and/or any information regarding the application of the product, Infineon Technologies hereby disclaims any and all warranties and liabilities of any kind, including without limitation warranties of non-infringement of intellectual property rights of any third party.

In addition, any information given in this document **is subject to customer’s compliance with its obligations** stated in this document and any applicable legal requirements, norms and standards concerning customer’s products and any use of the product of Infineon Technologies in **customer’s applications**.

The data contained in this document is exclusively intended for technically trained staff. It is the **responsibility of customer’s technical departments** to evaluate the suitability of the product for the intended application and the completeness of the product information given in this document with respect to such application.

For further information on the product, technology, delivery terms and conditions and prices please contact your nearest Infineon Technologies office ([www.infineon.com](http://www.infineon.com)).

Please note that this product is not qualified according to the AEC Q100 or AEC Q101 documents of the Automotive Electronics Council.

**WARNINGS**

Due to technical requirements products may contain dangerous substances. For information on the types in question please contact your nearest Infineon Technologies office.

Except as otherwise explicitly approved by Infineon Technologies in a written document signed by authorized representatives of Infineon Technologies, **Infineon Technologies’ products may not be used** in any applications where a failure of the product or any consequences of the use thereof can reasonably be expected to result in personal injury.