



Energy Saving Products

101 N.Sepulveda Blvd, EL Segundo 90245 California, USA

IRAC27951SR

IRS27951 Evaluation Board User Guide

Table of Contents

1	INTRODUCTION.....	3
2	IRS27951/2 DESCRIPTION.....	3
3	IR11682 DESCRIPTION.....	4
4	EVALUATION BOARD SPECIFICATIONS.....	5
4.1	Board Description.....	5
4.2	Schematic.....	6
4.3	Evaluation Board Picture.....	7
4.4	Board Component Placement.....	7
4.5	Board PCB Layout.....	8
4.6	Bill of Materials.....	9
5	EVALUATION BOARD OPERATING PROCEDURE.....	10
5.1	Load Connection.....	10
5.2	AC/DC Input.....	10
5.3	IRS27951 DC Supply Voltage.....	11
5.4	Disconnect the Board.....	11
6	SYSTEM PERFORMANCE CHARACTERIZATION.....	12
6.1	Steady-State and Start-up Waveforms.....	12
6.2	Synchronous Rectifier Waveform.....	15
6.3	Dynamic Load Response & Output Voltage Regulation.....	16
6.4	Output Ripple.....	19
6.5	User Initiated SLEEP Mode.....	20
6.6	Efficiency Chart.....	21
6.7	Thermal Data.....	22
7	Transformer Spec.....	22
7.1	Electrical Diagram.....	22
7.2	Resonant Transformer Winding Position on Coil former.....	23
7.3	Resonant Transformer Winding Characteristics.....	23

1 INTRODUCTION

This document details the test procedure for validation of IRAC27951SR-240W Evaluation Board, featuring the IRS27951 Resonant Half Bridge controller and the IR11682 dual-channel synchronous rectification controller. The document includes schematic diagram, test setup, test procedure, and test results.

2 IRS27951/2 DESCRIPTION

The IRS2795(1,2) is an 8 pin, high-voltage, double-ended controller specific for the resonant half-bridge topology. It provides 50% complementary duty cycle; the high-side and the low-side devices are driven 180° out-of-phase for exactly the same time. The IC incorporates additional protection features for robust operation and provides a high performance solution while minimizing external components and printed circuit board area.

The IC enables the designer to externally program all the following features using a 2 pin oscillator - operating frequency range (minimum and maximum frequency), startup frequency, dead time, soft-start time and sleep mode. Each of these functions are programmed as follows –

The minimum frequency is programmed using RT and CT.

The dead time is programmed using CT.

RSS and CSS program the converter soft-start time.

RSS//RT and CT program the converter start-up frequency.

The converter maximum frequency is set by (Rmax//RT) and CT.

Sleep mode is initiated by pulling the CT/SD to COM.

At start-up, to prevent uncontrolled inrush current, the switching frequency starts from a programmable maximum value and progressively decays until it reaches the steady-state value determined by the control loop. This frequency shift is non linear to minimize output voltage overshoot and its duration is programmable as well. Output voltage regulation is obtained by modulating the operating frequency. An externally programmable dead time is inserted between the turn-OFF of one switch and the turn-ON of the other one allows device zero-voltage turn-on transitions.

IRS2795 uses IR's proprietary high-voltage technology to implement a VS sensing circuitry that monitors the current through the low-side half bridge MOSFET for short circuit faults. By using the $R_{DS(on)}$ of the low-side MOSFET, the IRS2795 eliminates the need for an additional current sensing resistor, filter and current-sensing pin. This protection feature is latched and the thresholds are fixed at **2V for IRS27951** and **3V for IRS27952**.

Finally, the controller IC also features a micro power startup current ($I_{CC} < 100\mu A$) and a user initiated sleep mode during which the IC power consumption is less than $200\mu A$ (@ $V_{CC} = 15V$). The sleep mode function allows system designs with reduced standby power consumption and can be used to meet stringent energy standards from Blue Angel, Energy Star etc.

3 IR11682 DESCRIPTION

IR11682 is a secondary-side SmartRectifier™ driver IC designed to drive two N-Channel power MOSFETs used as synchronous rectifiers in resonant converter applications. The IC can control one or more paralleled N MOSFETs to emulate the behavior of Schottky diode rectifiers. The drain to source for each rectifier MOSFET voltage is sensed differentially to determine the level of the current and the power switch is turned ON and OFF in close proximity of the zero current transition.

When the conduction phase of the SR FET is initiated, current will start flowing through its body diode, generating a negative VDS voltage across it. The body diode has generally a much higher voltage drop than the one caused by the MOSFET on resistance and therefore will trigger the turn-on threshold V_{TH2} . When V_{TH2} is triggered, IR11682 will drive the gate of MOSFET on which will in turn cause the conduction voltage VDS to drop down to $I_D \cdot R_{DS(on)}$. This drop is usually accompanied by some amount of ringing, that could trigger the input comparator to turn off; hence, a fixed Minimum On Time (MOT) blanking period is used that will maintain the power MOSFET on for a minimum amount of time.

Once the SR MOSFET has been turned on, it will remain on until the rectified current will decay to the level where VDS will cross the turn-off threshold V_{TH1} . Once the threshold is crossed, the current will start flowing again through the body diode, causing the VDS voltage to jump negative. Hence, V_{TH2} is blanked for a time duration t_{BLANK} after V_{TH1} is triggered. When the device VDS crosses the positive reset threshold V_{TH3} , t_{BLANK} is terminated and the IC is ready for next conduction cycle as shown below.

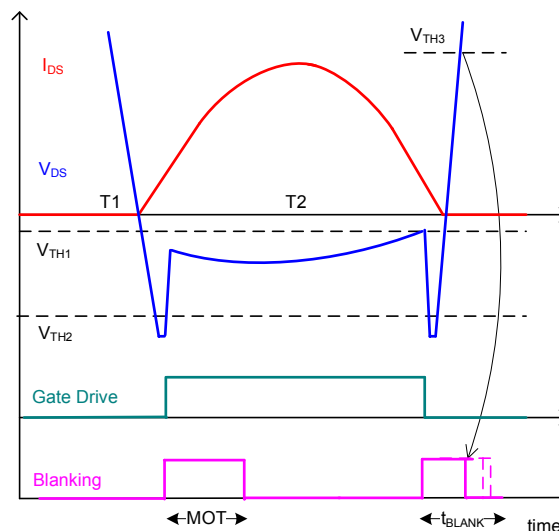

IR11682 further simplifies synchronous rectifier control by offering the following power management features:

- Wide VCC operating range allows the IC to be directly powered from the converter output
- Shoot through protection logic that prevents both the GATE outputs from the IC to be high at the same time
- Device turn ON and OFF in close proximity of the zero current transition with low turn-on and turn-off propagation delays; eliminates reactive power flow between the output capacitors and power transformer
- Cycle-by-cycle MOT protection circuit can automatically detect no load condition and turn off gate driver output to avoid negative current flowing through the MOSFETs
- Internally clamped gate driver outputs that significantly reduce gate losses

4 EVALUATION BOARD¹ SPECIFICATIONS

Input Voltage.....	280VAC or 400VDC
AC Line Frequency Range.....	47 – 63Hz
Converter Switching Frequency Range.....	70-150 kHz
Converter Output.....	24V/10A
Maximum Output Power.....	240W
Minimum Load Requirement.....	None
Maximum Ambient Operating Temperature.....	40°C ²
Efficiency (@ 240W).....	95%
Short Circuit Protection.....	Yes
Double Layer PCB with 2oz Copper	

There are high voltages present whenever the board is energized and proper precautions should be taken to avoid potential shock and personal injury.

4.1 Board Description

The evaluation board consists of a front-end AC-DC rectifier stage cascaded with a half-bridge resonant DC-DC converter with 24V output voltage rail.

The front end is a conventional rectifier stage with a rectifier bridge and an EMI filter.

The downstream converter is a multi-resonant half bridge LLC converter whose control is implemented with the IRS27951 (U1) controller HVIC. The controller drives the two half-bridge MOSFETs with a 50 percent fixed duty cycle with dead-time, changing the frequency according to the feedback signal in order to regulate the output voltage against load and input voltage variations. As described earlier, in addition to current protection, all the critical functions needed to control resonant converter designs can be externally programmed using this 8 pin controller IC.

IRS27951 is self-supplied in this reference design. The startup resistors Rstart1~Rstart3 provide startup current to IRS27951 during power up and charge the Vcc capacitors (CDC2 and CVcc1). Once Vcc voltage exceeds Vccuv+ threshold, IRS27951 starts operation and the auxiliary winding of power transformer can

¹ Please note that EMI measurements have not been performed on this evaluation board. The primary goal of this board is to verify the functionality of the IRS27951 controller IC.

² A fan is recommended whenever operating at the maximum load for a prolonged period of time.

provide bias to the IC. The voltage of auxiliary winding could vary a lot when 24V load changes from 0A to 10A, so a linear regulator – Dz4, Rvcc and Q2 – is used to keep Vcc regulated at 14.5V.

The transformer uses the magnetic integration approach, incorporating the resonant series and shunt inductances in the power transformer. The transformer configuration chosen for the secondary winding is center-tap. The feedback loop is implemented by means of a classical configuration using a TL431 (U3) to adjust the current in the optocoupler TLP621 (U2). The optocoupler transistor modulates the current from the RT pin of the controller IC to modulate the switching frequency, thus achieving output voltage regulation.

The secondary rectification is implemented with synchronous rectification controller IR11682 and two PQFN power MOSFETs. Each leg of the output uses one IRFH5006, a 60V MOSFET with 3.5mohm on state resistance (typical). The conduction power loss is greatly reduced by using synchronous rectification. No heatsink is required for 10A continuous output current. PCB area is also saved with the highly integrated dual-channel SmartRectifier™ controller IR11682.

The synchronous rectification circuit is connected in a low-side configuration. So IR11682 can directly drive the two SR MOSFETs. A RCD circuit is added to IR11682 VD sensing input to provide leading edge filter and turn-off delay compensation.

IR11682 is biased by 24V output through a simple linear voltage regulator Q1 (a general NPN transistor) and zener Dz2 (12V). In addition, a second zener diode Dz3 (9.1V) is used to prevent the synchronous rectifier circuit be activated when output voltage is still low. The IR11682 will start operation when output voltage is approaching 18V.

4.2 Schematic

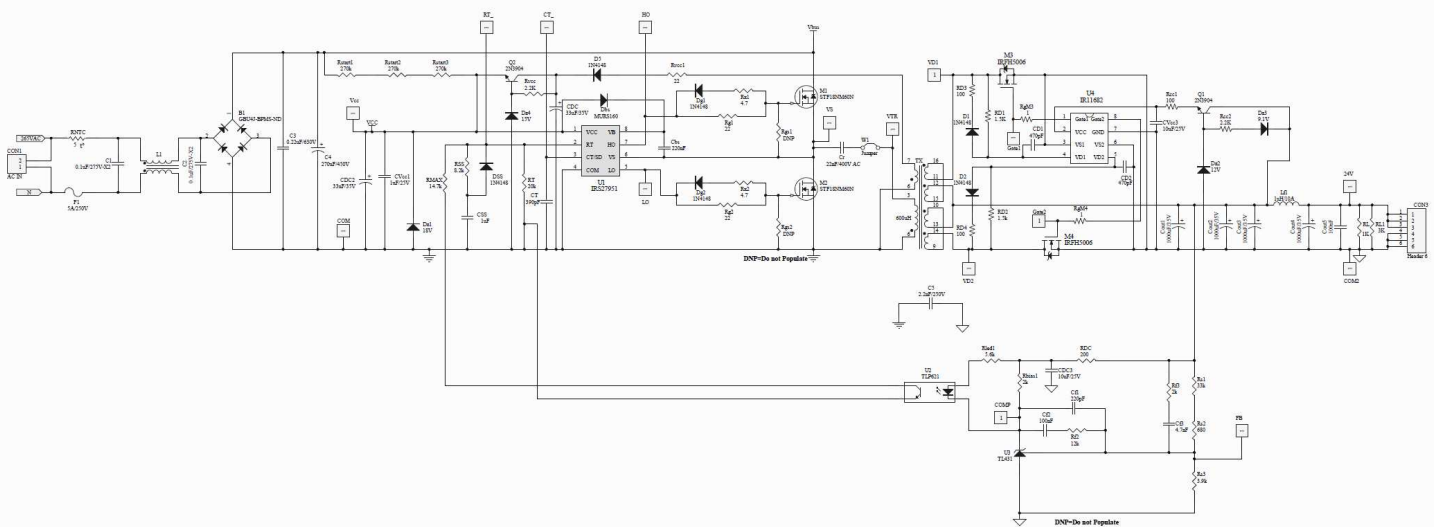

Figure 1 – Evaluation Board Schematic

4.3 Evaluation Board Picture

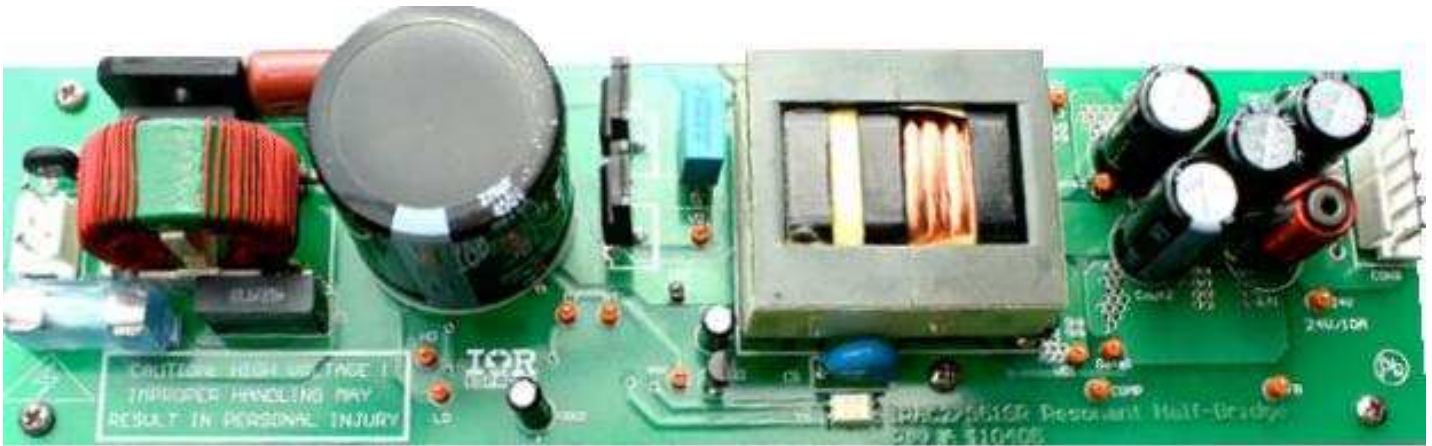

Figure 2 – Evaluation Board Photo

4.4 Board Component Placement

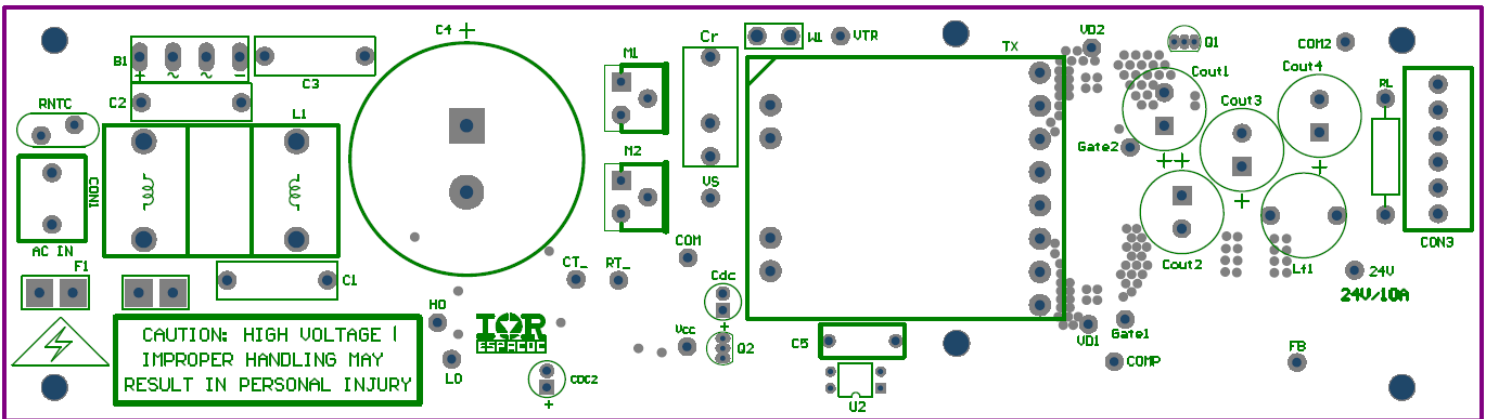

Figure 3 – Evaluation Board Top Side Component Placement

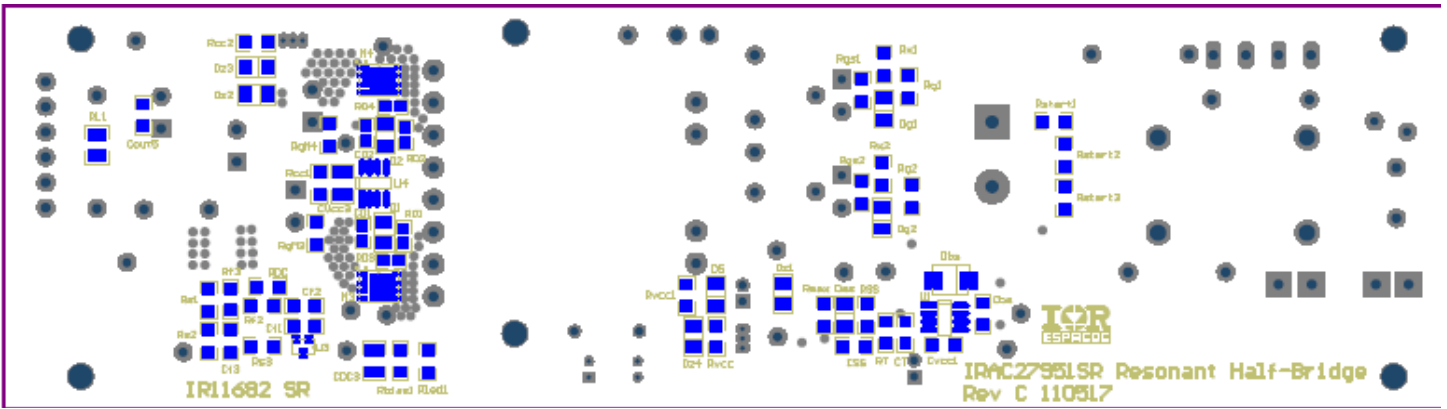

Figure 4 – Evaluation Board Bottom Side Component Placement

4.5 Board PCB Layout

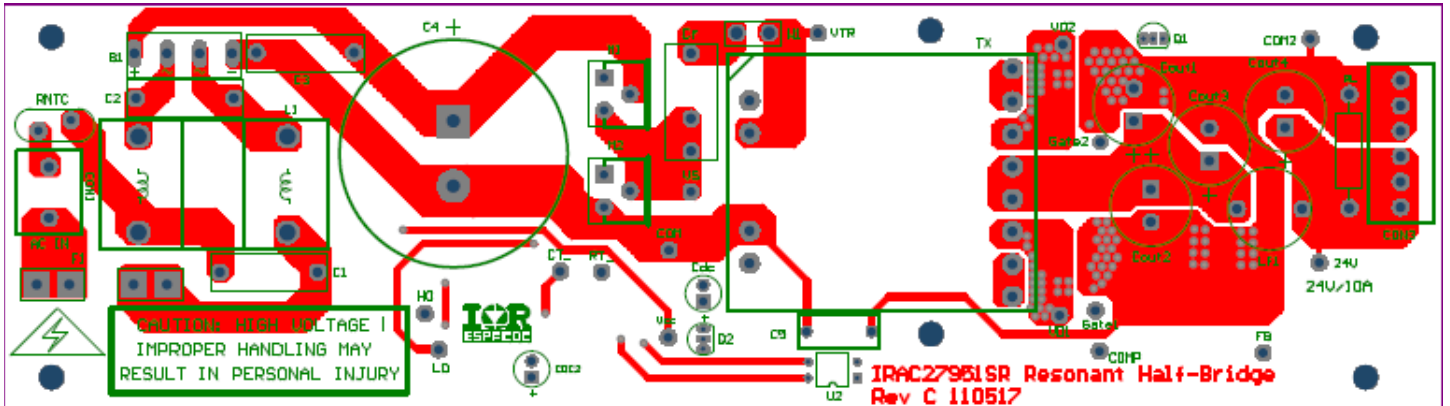

Figure 5 - Board Top Layer Copper

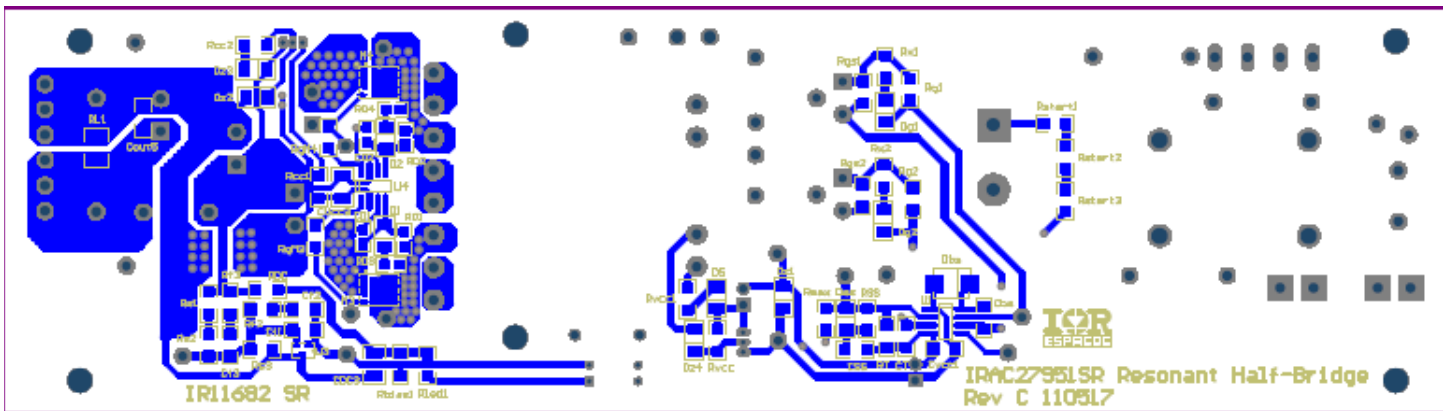

Figure 6 - Board Bottom Layer Copper

4.6 Bill of Materials

Designator	Description	Quantity	Value/ Rating	Vendor	Part#
24V, COMP, CT_, FB, Gate1, Gate2, HO, LO, RT_, Vcc, VD1, VD2, VS, VTR	Test Point PC Mini 0.040"D	14	Red	DIGIKEY	5000K-ND
B1	Single Phase Bridge Rectifier	1	GBU4J-BPMS-ND	DIGIKEY	GBU4J-BPMS-ND
C1, C2	X2 Safety Capacitor	2	0.1uF/275V-X2	DIGIKEY	P10730-ND
C3	Metal Poly Capacitor	1	0.22uF/630V	DIGIKEY	P12173-ND
C4	Electrolytic Bulk Capacitor TS-HC	1	270uF/450V	DIGIKEY	P14116-ND
C5	250VAC Y1 Safety Ceramic Disc Capacitor	1	2.2nF/250V	DIGIKEY	445-2411-ND
Cbs	1206 General Purpose Ceramic SMD	1	220nF	DIGIKEY	490-1776-1-ND
CD1, CD2	0805 General Purpose Ceramic SMD	2	470pF	DIGIKEY	311-1119-1-ND
CDC, CDC2	Electrolytic Capacitor FM Radial	2	33uF/35V	DIGIKEY	565-1687-ND
Cf1	1206 General Purpose Ceramic SMD	1	220pF/50V	DIGIKEY	478-1484-1-ND
Cf2, Cout5	1206 General Purpose Ceramic SMD	2	100nF	DIGIKEY	490-1775-1-ND
Cf3	1206 General Purpose Ceramic SMD	1	4.7nF	DIGIKEY	490-3357-6-ND
COM, COM2	Test Point PC Mini 0.040"D	2	Black	DIGIKEY	5001K-ND
CON1	CONN HEADER 3POS 0.156 VERT TIN	1	AC IN	DIGIKEY	WM4621-ND
CON3	CONN HEADER 6POS 0.156 VERT TIN	1	Header 6	DIGIKEY	WM4624-ND
Cout1, Cout2, Cout3, Cout4	Aluminium Electrolytic Capacitor FM RAD	4	1000uF/35V	DIGIKEY	P12405-ND
Cr	Polypropylene Capacitor High Ripple	1	22nF/400V AC	DIGIKEY	495-1329-ND
CSS, CVcc1	1206 General Purpose Ceramic SMD	2	1uF/25V	DIGIKEY	445-1592-1-ND
CT	1206 General Purpose Ceramic SMD	1	390pF	DIGIKEY	478-1487-1-ND
CVcc3, CDC3	1210 General Purpose Ceramic SMD	2	10uF/25V	DIGIKEY	445-3942-1-ND
D1, D2, D5, Dg1, Dg2, DSS	Fast Recovery Diode SMD	6	1N4148	DIGIKEY	1N4148W-FDICT-ND
Dbs	Fast Rectifier diode SMB	1	MURS160	DIGIKEY	MURS160-FDICT-ND
Dz1	Zener Diode SOD80	1	18V	DIGIKEY	FLZ18VCCT-ND
Dz2	Zener Diode SOD80	1	12V	DIGIKEY	FLZ12VCCT-ND
Dz3	Zener Diode SOD80	1	9.1V	DIGIKEY	FLZ9V1CCT-ND
Dz4	Zener Diode SOD80	1	15V	DIGIKEY	FLZ15VCCT-ND
F1	FUSE IEC FA LBC 5x20	1	5A/250V	DIGIKEY	F2395-ND
L1	EMI Common Mode Choke	1	Trans Cupl	COILCRAFT	CMT2-6.5-2L
Lf1	PCV Series Drum Core Inductor	1	1uH/10A	COILCRAFT	PCV-0-102-10L
M1, M2	TO-220 N-Channel Power MOSFET	2	STF18NM60N	DIGIKEY	STF18NM60N
M3, M4	N-Channel MOSFET 60V PQFN	2	IRFH5006	INTERNATIONAL RECTIFIER	IRFH5006
Q1, Q2	NPN General Purpose Amplifier	2	2N3904	DIGIKEY	2N3904-APCT-ND
Rbias1, Rf3	1206 SMD Film RED 1/4W 5%	2	2k	DIGIKEY	RHM2.00kFCT-ND
Rcc1	1206 SMD Film RED 1/4W 5%	1	100	DIGIKEY	RHM100FCT-ND
Rcc2, Rvcc	1206 SMD Film RED 1/4W 5%	2	2.2K	DIGIKEY	RHM2.20kFCT-ND
RD1, RD2	0805 SMD Film RED 1/4W 5%	2	1.5K	DIGIKEY	RHM1.50kCCT-ND
RD3, RD4	0805 SMD Film RED 1/4W 5%	2	100	DIGIKEY	RHM100CCT-ND
RDC	1206 SMD Film RED 1/4W 5%	1	200	DIGIKEY	RHM200FCT-ND
Rf2	1206 SMD Film RED 1/4W 5%	2	12k	DIGIKEY	RHM12.0kFCT-ND
Rg1, Rg2, Rvcc1	1206 SMD Film RED 1/4W 5%	3	22	DIGIKEY	RHM22.0FCT-ND
RgM3, RgM4	1206 SMD Film RED 1/4W 5%	2	1	DIGIKEY	RHM1.00FCT-ND
Rgs1, Rgs2	1206 General Purpose SMD	2	DNP	DIGIKEY	NOT USED
RL	Resistor 1W 5%	1	1K	DIGIKEY	RSF100JB-1K0
RL1	1210 Resistor 0.5W 5%	1	3K	DIGIKEY	541-3.0KVCT-ND
Rled1	1206 SMD Film RED 1/4W 1%	1	5.6k	DIGIKEY	RHM5.60kFCT-ND
RMAX	1206 SMD Film RED 1/4W 1%	1	14.7k	DIGIKEY	RHM14.7kFCT-ND
RNTC	Inrush Current Limiter	1	5	DIGIKEY	495-2093-ND
Rs1	1206 SMD Film RED 1/4W 1%	1	33k	DIGIKEY	RHM33.0kFCT-ND
Rs2	1206 SMD Film RED 1/4W 1%	1	680	DIGIKEY	RHM680FCT-ND
Rs3	1206 SMD Film RED 1/4W 1%	1	3.9k	DIGIKEY	RHM3.90kFCT-ND
RSS	1206 SMD Film RED 1/4W 1%	1	8.2k	DIGIKEY	RHM8.20kFCT-ND
Rstart1, Rstart2, Rstart3	1206 SMD Film RED 1/4W 5%	3	270K	DIGIKEY	RHM270kFCT-ND
RT	1206 SMD Film RED 1/4W 1%	1	20k	DIGIKEY	RHM20.0kFCT-ND
Rx1, Rx2	1206 SMD Film RED 1/4W 5%	2	4.7	DIGIKEY	311-4.70FRCT-ND
TX	Resonant Power Transformer	1	TRANSYJ	YUJING	LP3925H
U1	IRS27951 Control IC	1	IRS27951	INTERNATIONAL RECTIFIER	IRS27951
U2	Photocoupler TRANS-OUT 4-DIP	1	TLP621	DIGIKEY	TLP621FT-ND
U3	Programmable Voltage Regulator SOT23-3	1	TL431	DIGIKEY	568-4883-1-ND
U4	Sync Rect Controller	1	IR11682	INTERNATIONAL RECTIFIER	IR11682S

5 EVALUATION BOARD OPERATING PROCEDURE

CAUTION: Potentially lethal voltages exist on this demo board when powered up. Improper or unsafe handling of this board may result in serious injury or death.

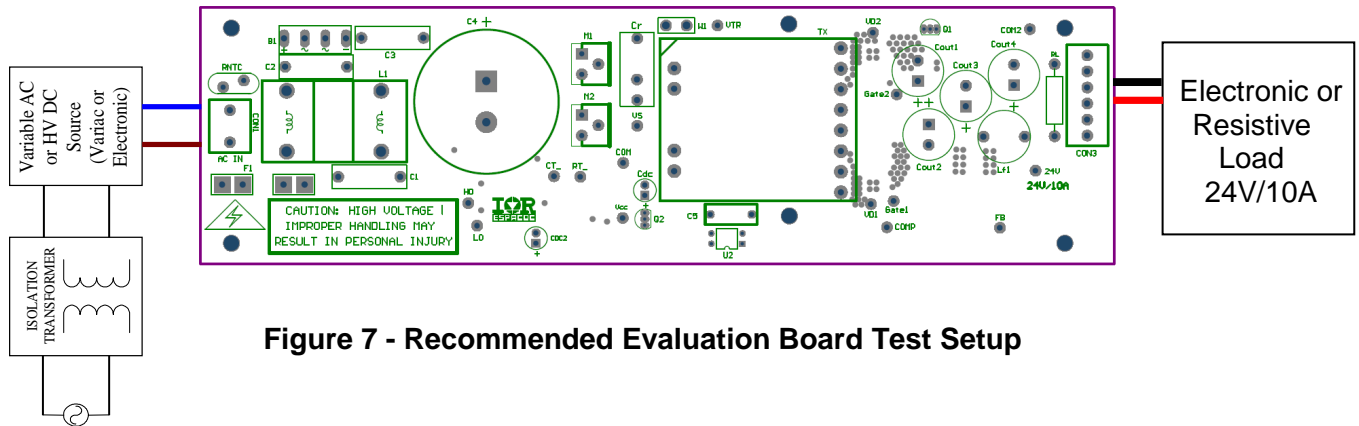

Figure 7 - Recommended Evaluation Board Test Setup

5.1 Load Connection

Connect a resistive or electronic load, capable of 240W continuous power on the 24V rail to connector CON3. Please note that there is no minimum load³ requirement for this board.

5.2 AC/DC Input

The evaluation board can take either AC or DC input voltage. If an AC source is used, an isolation transformer on the AC side is highly recommended, so that all the control signals on the test points can easily be probed by using regular scope probes. Connect an AC power source capable of operation up to 280VAC or a 400V DC source to CON1. The converter can keep the output regulated when the BUS voltage is in the range of 350V DC to 420V DC.

The NTC resistor limits the inrush current upon initial application of full AC line voltage. Once power is applied to demo board, potentially lethal high voltages will be present on board and necessary precautions should be taken to avoid serious injury.

³ A dummy load has been added to the output rail to ensure tight voltage regulation from no load to full load.

5.3 IRS27951 DC Supply Voltage

The board is self-supplied by startup circuit and auxiliary winding of transformer. The startup circuit starts to work once AC or DC input voltage applies to the board. However, the Vcc will be stable only when BUS voltage is 350Vdc or above. The VCC voltage is monitored at test points VCC and COM.

5.4 Disconnect the Board

It is recommended to discharge the bulk capacitor C4 every time after evaluation is finished:

- Disconnect the high voltage AC or DC source from CON1
- Apply an external 12V DC voltage to primary Vcc and COM test points for a while until bus voltage drops to 0V

6 SYSTEM PERFORMANCE CHARACTERIZATION

6.1 Steady-State and Start-up Waveforms

Test Conditions – $V_{IN} = 350V$ DC; Full Load (24V/10A); No Load (24V/0A)

Ch 1: Low-side device V_{GS} – Ch 2: Voltage at VS pin

Ch 4: Resonant tank current

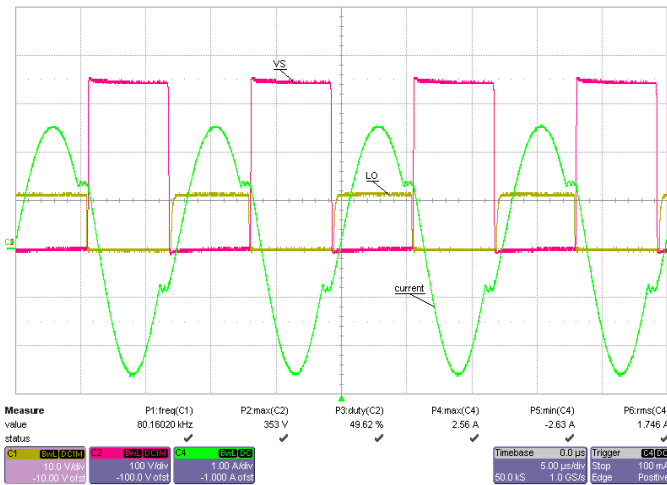

Full Load Operation

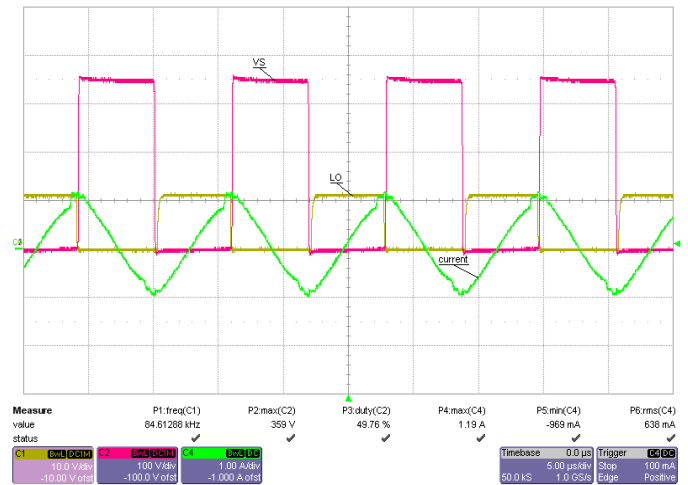

No Load Operation

Ch 2: Output Voltage Ch 4: Resonant tank current

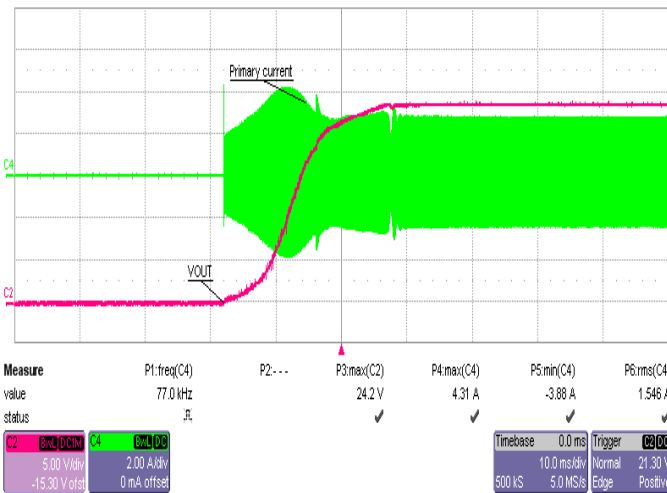

Full Load Start-up

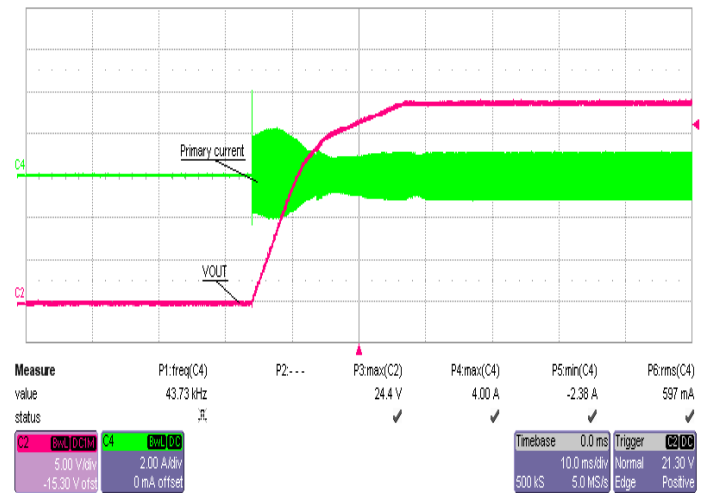

No Load Start-up

At startup, synchronous rectifier circuit activates when V_{out} voltage is around 18V. As the voltage drop of SR MOSFET is 0.6V lower than body diode forward voltage drop, the output voltage has a small step-up. It also causes primary current a small peaking due to the charging current of output capacitor.

Test Conditions – $V_{IN} = 390V$ DC; Full Load (24V/10A); No Load (24V/0A)

Ch 1: Low-side device V_{GS} – Ch 2: Voltage at VS pin

Ch 4: Resonant tank current

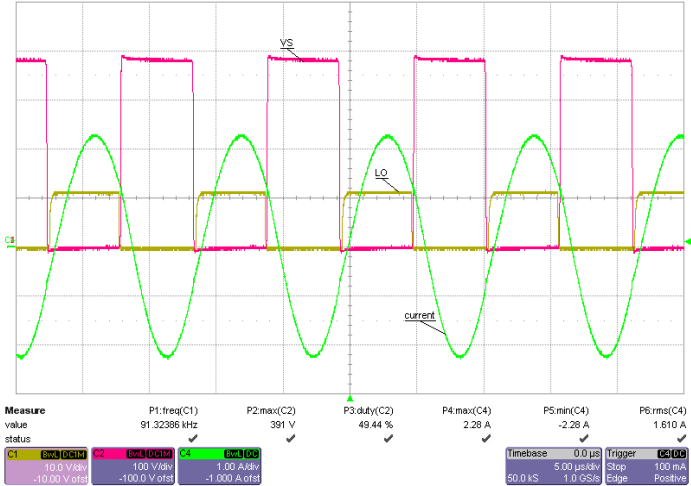

Full Load Operation

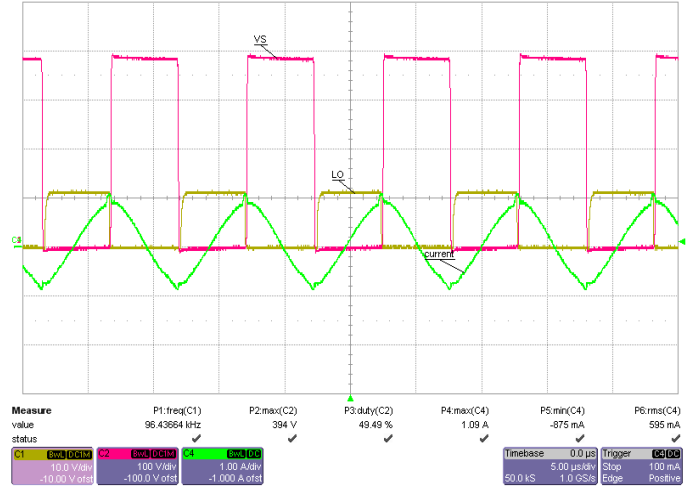

No Load Operation

Ch 2: Output Voltage Ch 4: Resonant tank current

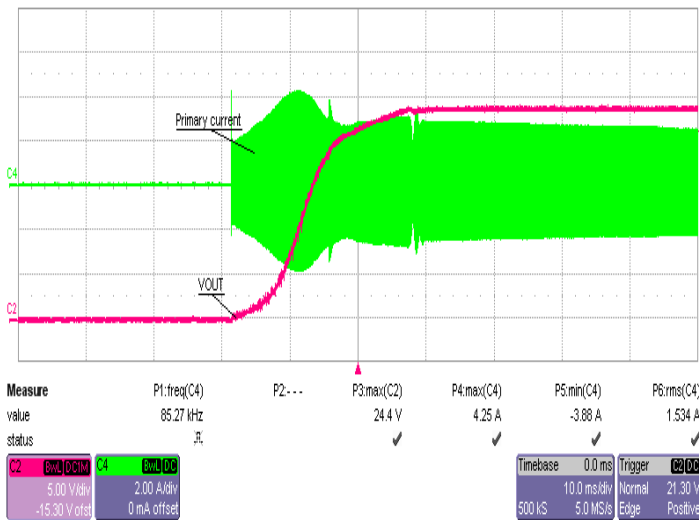

Full Load Start-up

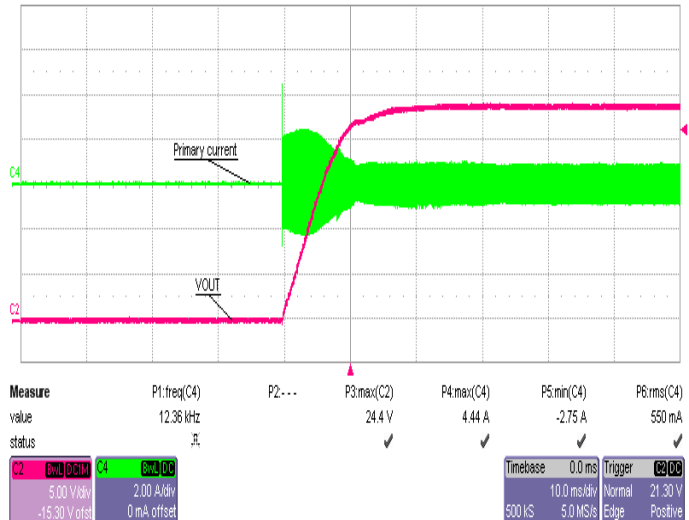

No Load Start-up

The switching frequency sweeps from 200kHz to regulation frequency in 10ms~15ms, prevents high current spike during startup. The output voltage has no overshoot during startup.

Test Conditions – $V_{IN} = 420V$ DC; Full Load (24V/10A); No Load (24V/0A)

Ch 1: Low-side device V_{GS} – Ch 2: Voltage at VS pin

Ch 4: Resonant tank current

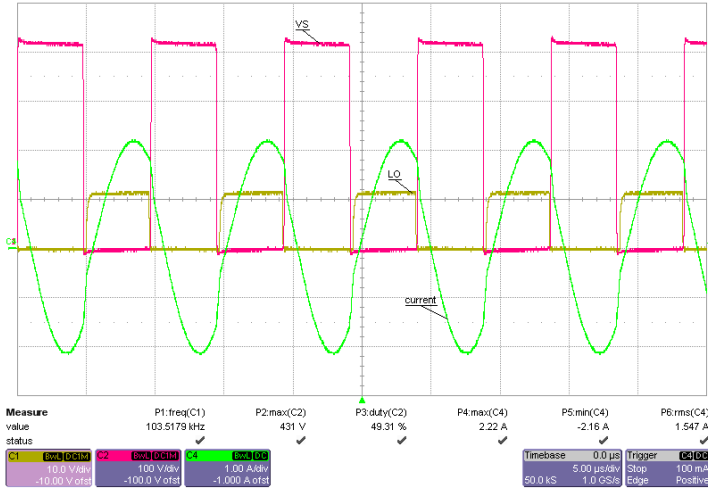

Full Load Operation

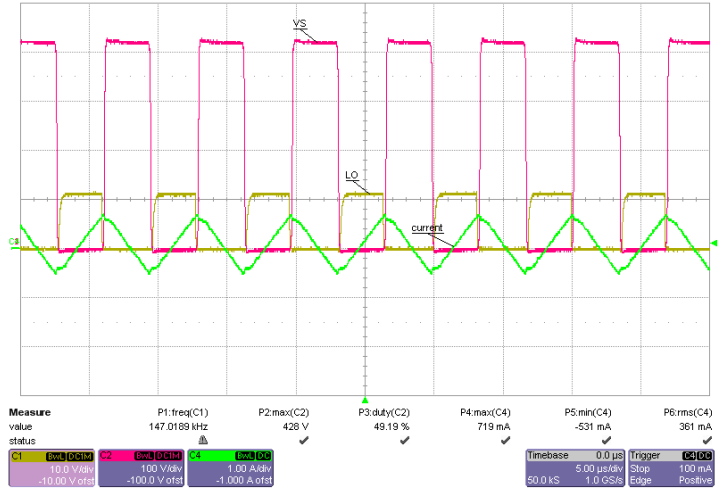

No Load Operation

Ch 2: Output Voltage Ch 4: Resonant tank current

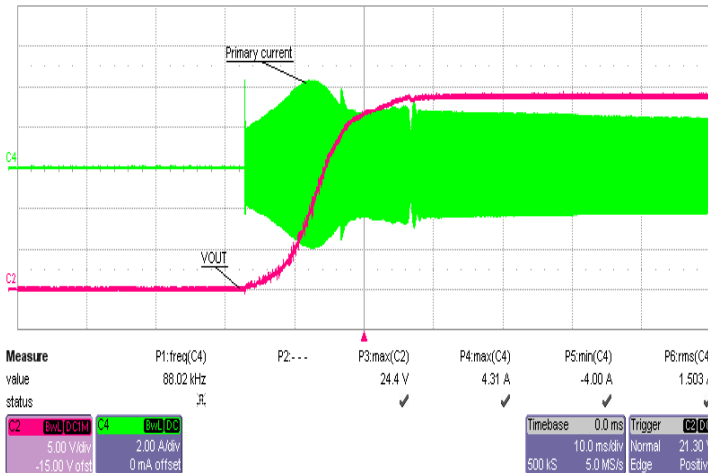

Full Load Start-up

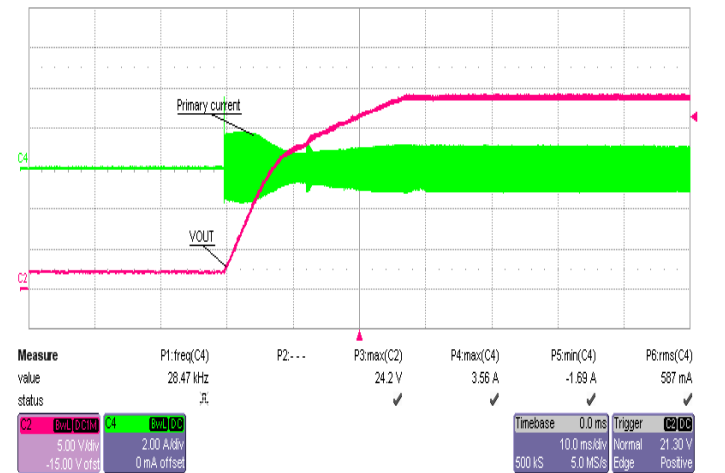

No Load Start-up

6.2 Synchronous Rectifier Waveform

Ch 1: SR gate1 – Ch 2: SR gate2

Ch 3: Voltage at VS pin – Ch 4: Resonant tank current

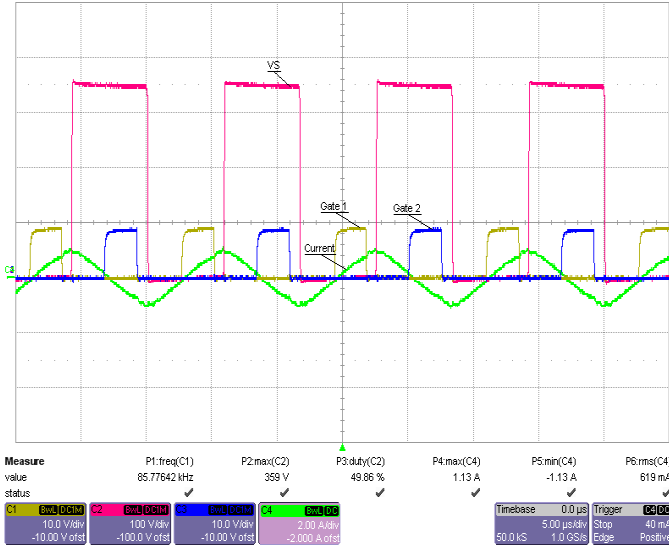

350Vdc, No Load Operation

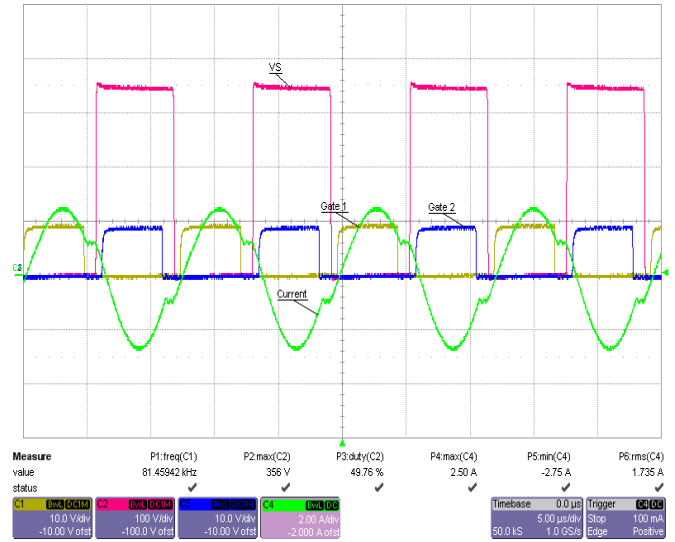

350Vdc, Full Load Operation

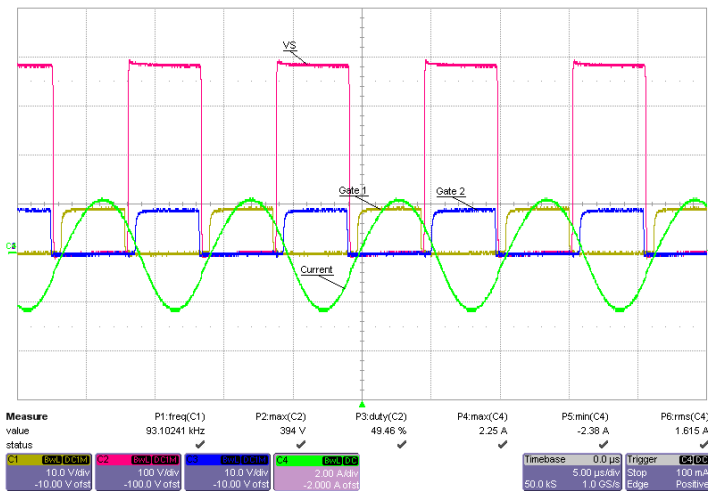

385Vdc, Full Load Operation

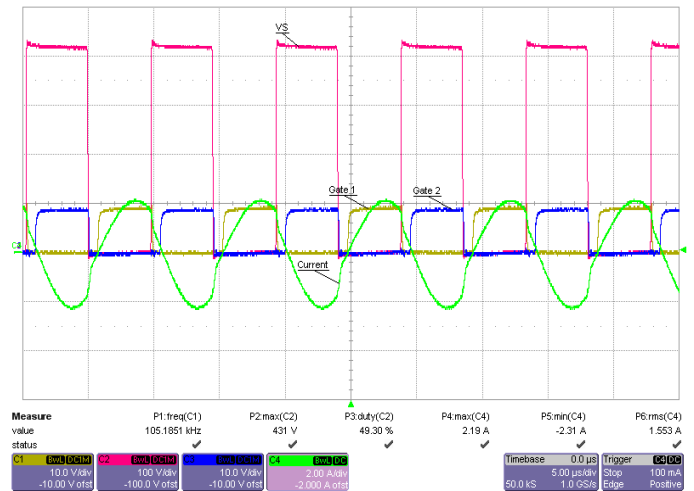

420Vdc, Full Load Operation

6.3 Dynamic Load Response & Output Voltage Regulation

A load step from full load to no load and from no load to full load was applied to test the dynamic response of the system. The undershoot and overshoot are within +/-3%.

Ch2: 24V Rail output voltage Ch 4: Resonant tank current

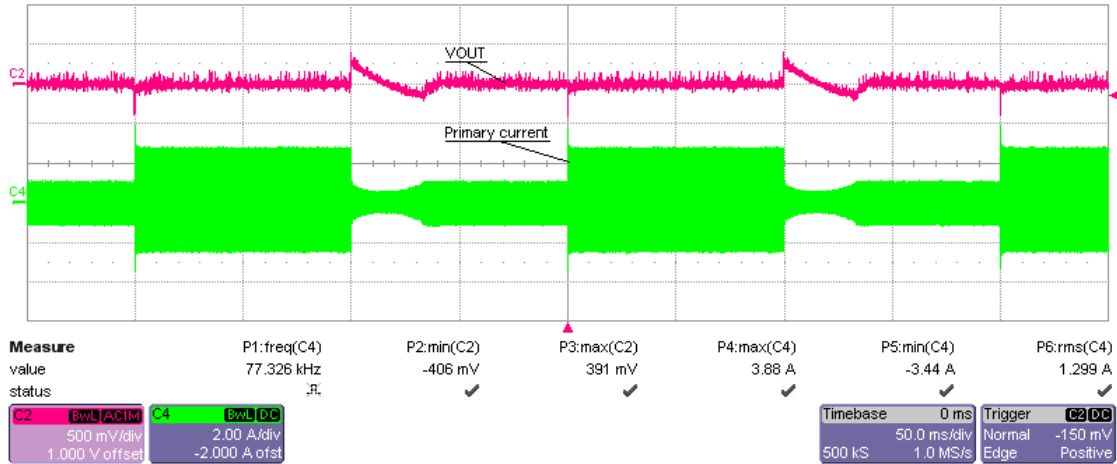

Load Step at 350Vdc input

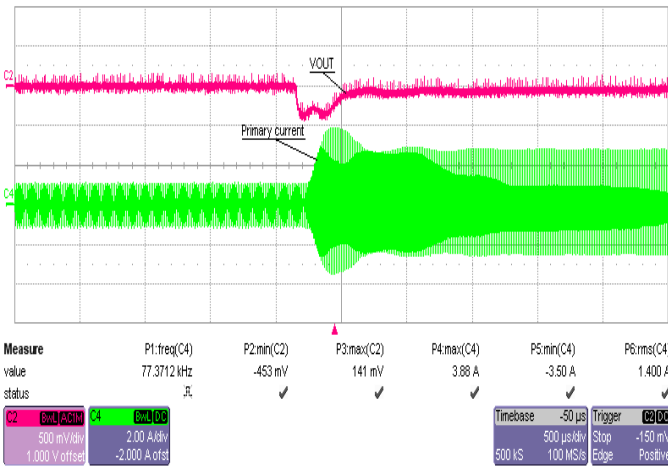

No Load to Full Load Step at 350Vdc

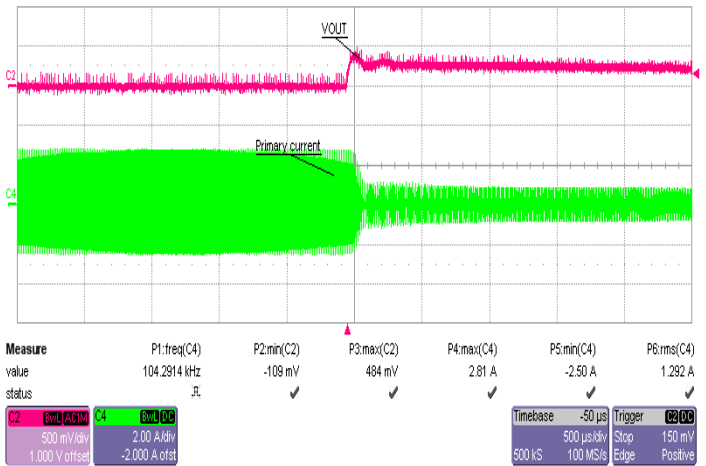

Full Load to No Load Step at 350Vdc

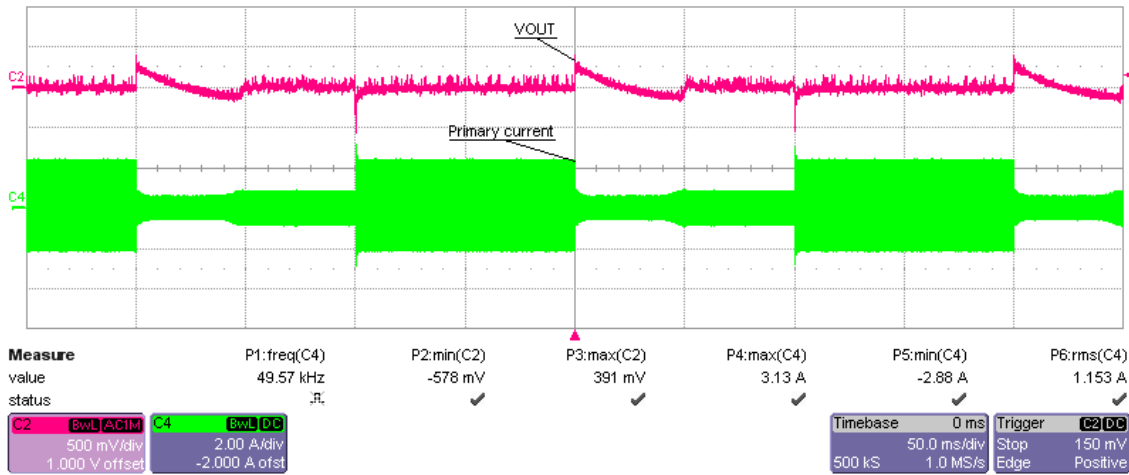

Load Step at 390Vdc input

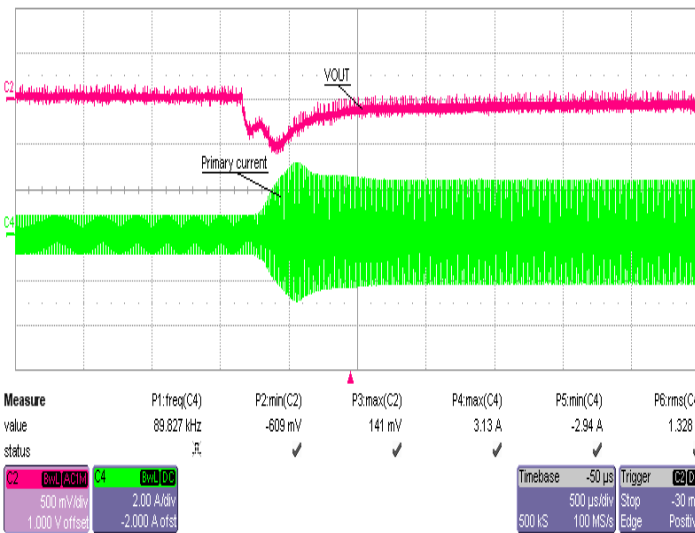

No Load to Full Load Step at 390Vdc

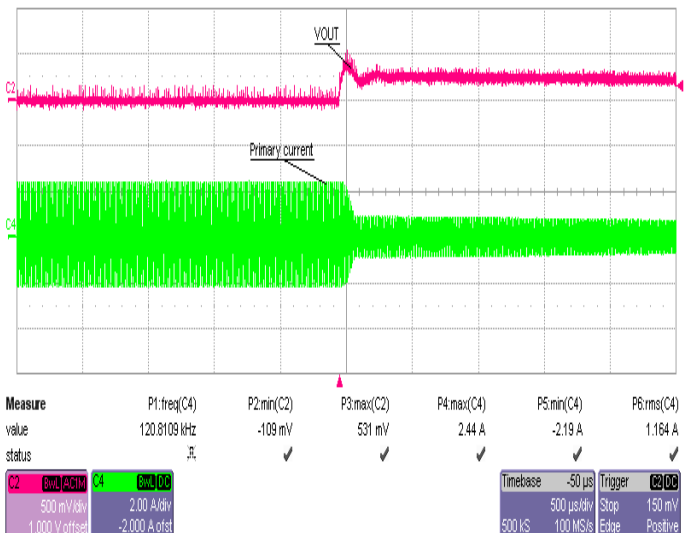

Full Load to No Load Step at 390Vdc

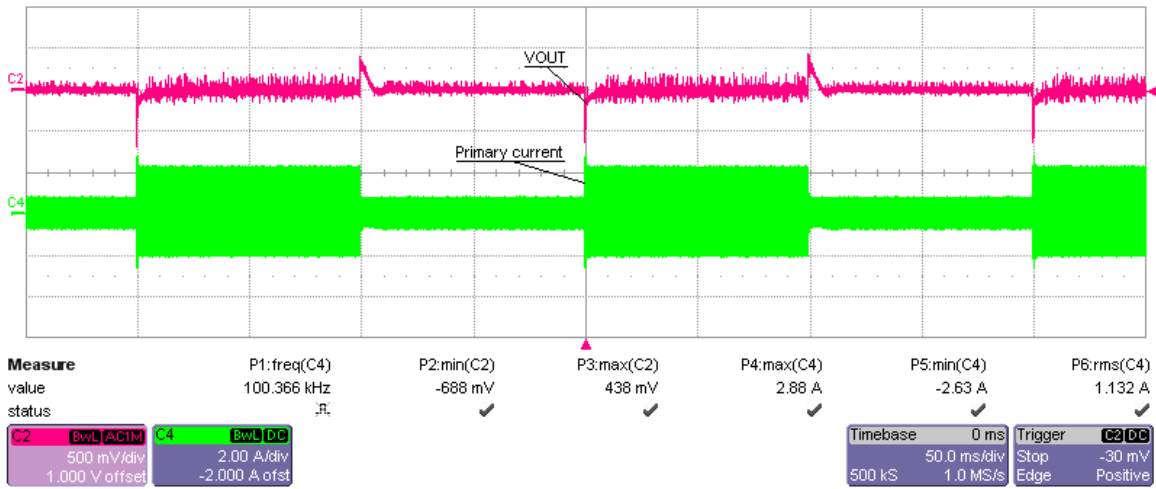

Load Step at 420Vdc input

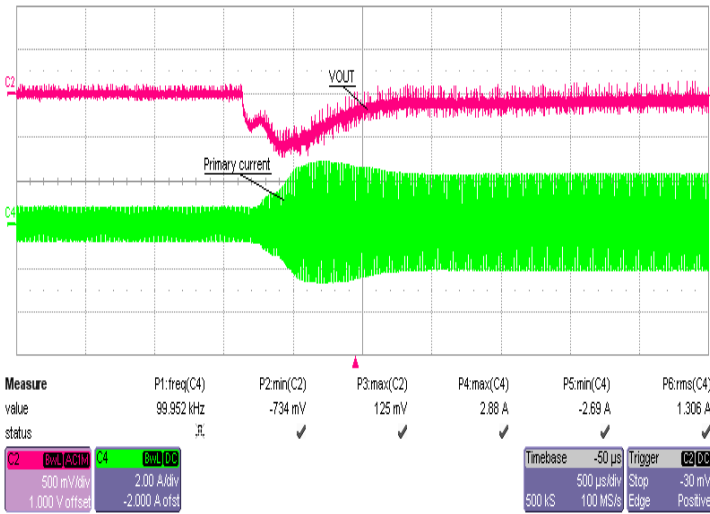

No Load to Full Load Step at 420Vdc

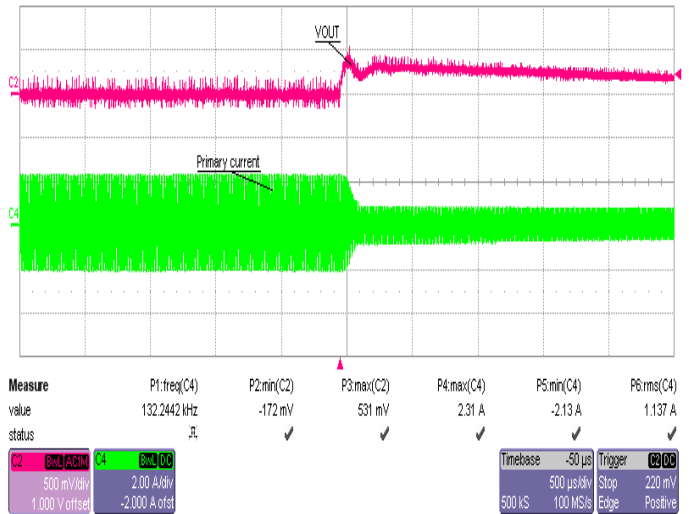

Full Load to No Load Step at 420Vdc

The output voltage is tightly regulated within a +/-1% regulation band over the entire line load range. A summary of the load performance is also shown below.

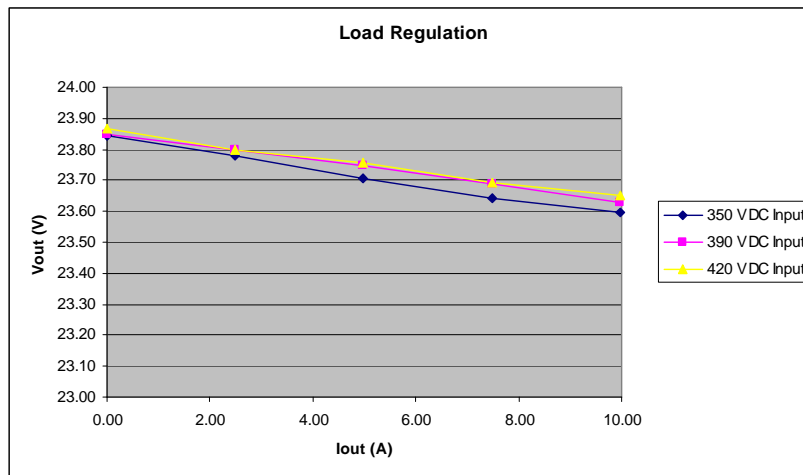
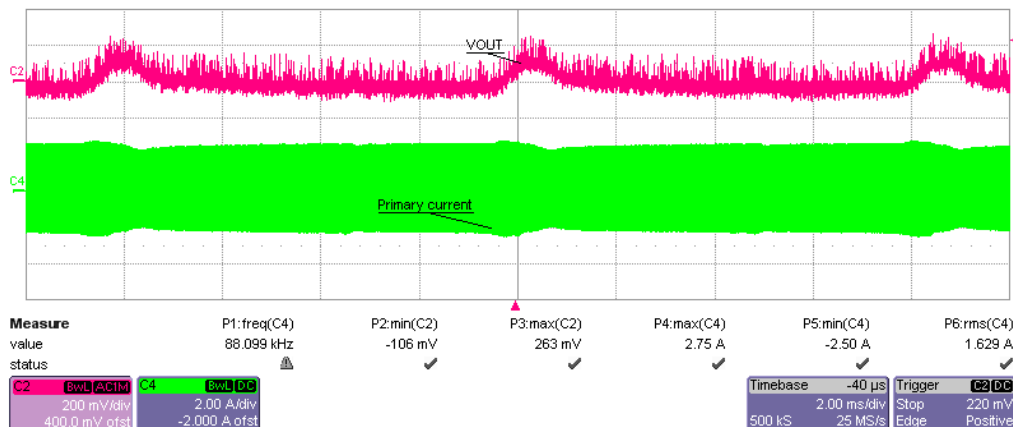

Figure 8 - Output voltage regulation plot

6.4 Output Ripple

The 24V output ripple is very tiny under DC input voltage. It is bigger with AC input. Below is the 24V ripple waveform tested at 270Vac and 10A full load.



The ripple is mainly due to the low frequency (2xfAC) ripple on primary bus voltage. It will be much smaller if use a PFC pre-regulator in the front stage.

At light load, the Sync Rect circuit could go into standby mode if output current is too small. The gate of IR11682 will be disabled and the body diode of SR MOSFET will carry output current. Depends on the load condition, IR11682 may have burst output as shown in the waveform. There will be some output ripple due to the burst operation of Sync Rect. The ripple is within 200mV and less than 1% of the rated output.

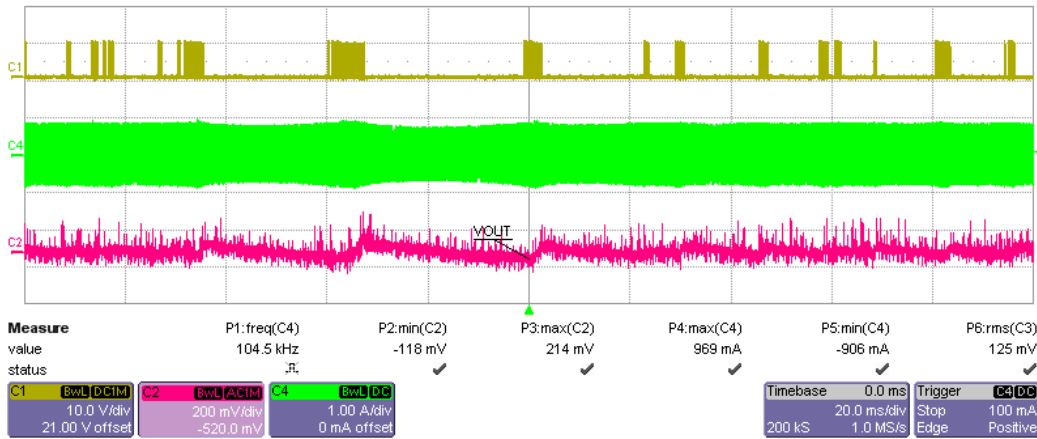

IR11682 in burst mode at 390Vdc, no load.

Ch1 is the gate1 of IR11682

6.5 User Initiated SLEEP Mode

The CT/SD pin of IRS27951 can be used to disable the IC and enter sleep mode in which the IC power consumption is highly minimized. The IC enters this mode when the CT/SD pin is externally pulled to COM. This feature facilitates the implementation of system power management functions for reducing overall standby power consumption by disabling the down converter when no power is being requested by the converter main output voltage rails.

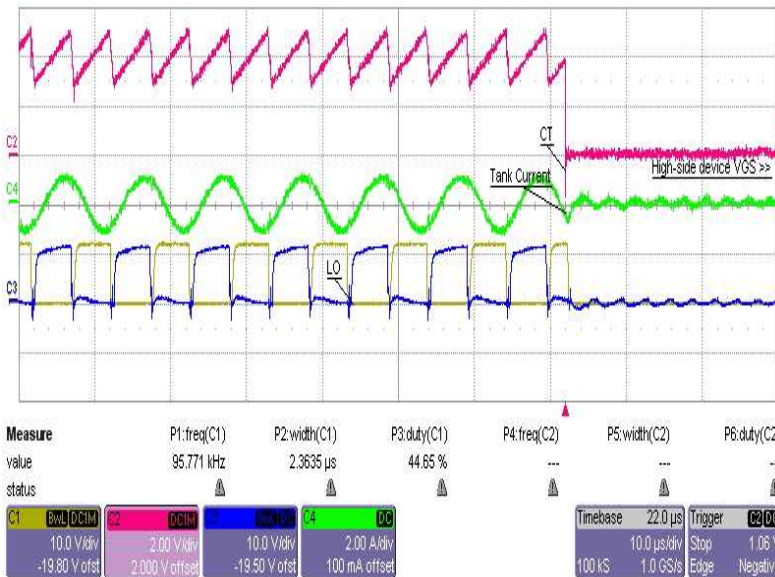

- Ch 1: Low-side device V_{GS}
- Ch 2: CT/SD pin of IRS27951
- Ch 3: High-side device V_{GS}
- Ch 4: Resonant tank current

Sleep mode initiated by externally pulling the CT/SD pin to COM

6.6 Efficiency Chart

The efficiency of IRS27951 demo board was tested at 350V, 390V and 420V DC input over the load range. The result is shown in the table below.

Vin DC(V)	Iout(A)	Vout(V)	Pout(W)	Pin(W)	Efficiency %
350	0.00	23.84	0.00	3.67	0.00
	2.48	23.78	59.05	64.10	92.12
	4.98	23.71	118.16	124.60	94.83
	7.48	23.64	176.85	186.20	94.98
	9.97	23.60	235.31	247.80	94.96
390	0.00	23.85	0.00	3.47	0.00
	2.48	23.80	59.07	64.00	92.30
	4.98	23.75	118.33	124.80	94.82
	7.48	23.69	177.27	186.00	95.31
	9.97	23.63	235.52	247.30	95.24
420	0	23.865	0.00	2.98	0.00
	2.482	23.8	59.07	64.2	92.01
	4.983	23.755	118.37	125	94.70
	7.483	23.692	177.29	186.5	95.06
	9.967	23.652	235.74	247.8	95.13

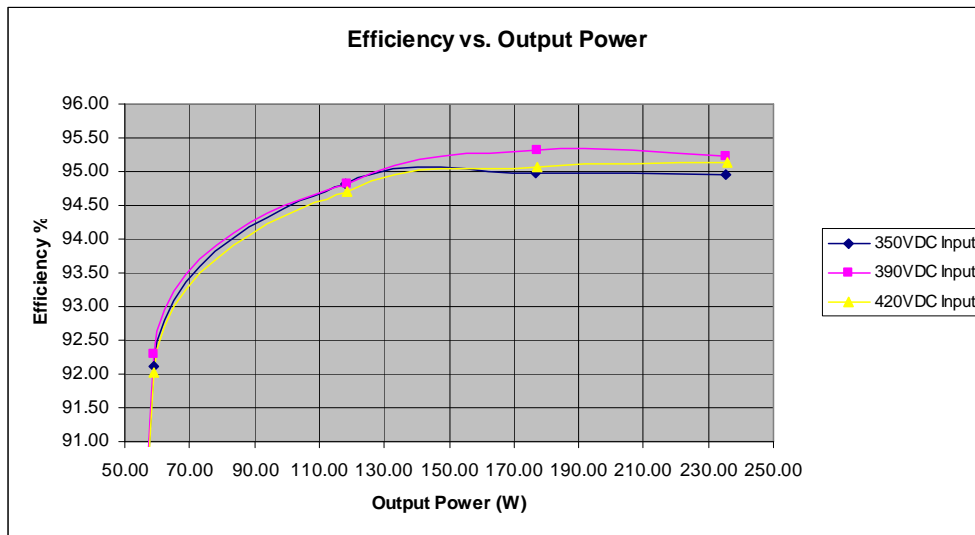

Figure 9 - Efficiency plot

6.7 Thermal Data

The thermal performance of IRS27951 demo board is tested at 400Vdc input and 240W full load at room temperature.

Part	Case Temperature (°C)
MOSFET M1	51
MOSFET M2	48
U1 IRS27951	40
Transformer	69
MOSFET M3	70
MOSFET M4	73

7 Transformer Spec

Minimum operating frequency: 80 kHz

Primary inductance: 600 μ H \pm 10% @1 kHz - 0.25V (*Note 1*)

Leakage inductance: 125 μ H \pm 10% @1 kHz - 0.25V (*Note 2*)

Note: 1 Measured between Pins 3 and 6

Note: 2 Measured between Pins 3 and 6 with secondary windings shorted

7.1 Electrical Diagram

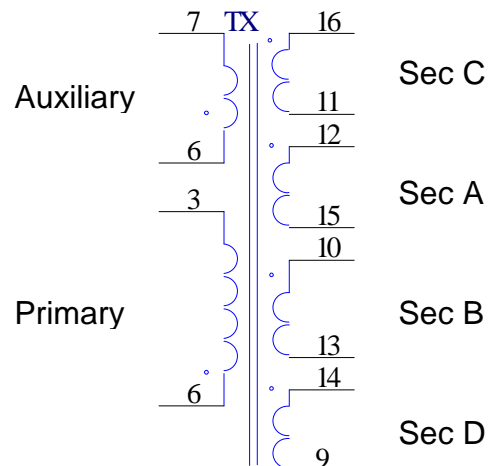

Note: pin9 is shorted to pin10 on PCB, pin12 is shorted to pin13 on PCB and pin15 is shorted to pin16 on PCB.

7.2 Resonant Transformer Winding Position on Coil former

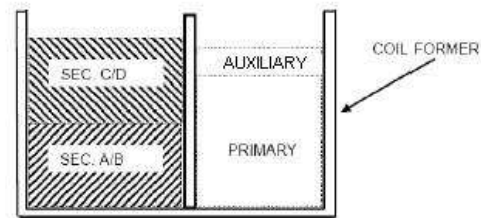

7.3 Resonant Transformer Winding Characteristics

Pins	Winding	Turn number	Wire type [mm]
3 - 6	Primary	36	LITZ - dia. 0.10x60
7 - 6	Auxiliary	2	Dia. 0.2
15 - 12	Sec. A	2	LITZ - dia. 0.10x250
13 - 10	Sec. B	2	LITZ - dia. 0.10x250
11 - 16	Sec. C	2	LITZ - dia. 0.10x250
9 - 14	Sec. D	2	LITZ - dia. 0.10x250

7.4 Resonant Transformer Vender and Part Number

Yu Jing Technology Co., LTD

LP3925H