

Surface Mount 2185.00MHz SAW Filter

AFS14A30-2185.00-T2

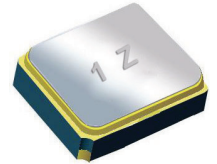

RoHS
Compliant



1.4 x 1.1 x 0.7 mm

FEATURES:

- 1.4 x 1.1 x 0.7 mm low profile SMT package
- Low Insertion loss
- Excellent selectivity with high out-of-band rejection

APPLICATIONS:

- Wireless Communication
- Remote Control
- Cellular Phones

ELECTRICAL SPECIFICATIONS:

Maximum Ratings

Item	Value
Input Power Level	+10 dBm max.
DC Permissive Voltage	3.0V DC max.
Operating Temperature Range	-30°C to + 105°C
Storage Temperature Range	-40°C to + 105°C

Parameters	Minimum	Typical	Maximum	Units	Notes
Center Frequency (f_c)		2185		MHz	
Insertion Loss (IL)		2.0	3.50	dB	(2170.00~2200.00MHz)
3-dB Bandwidth		30.00		MHz	
Amplitude Ripple		0.50	2.30	dB	(2170.00~2200.00MHz)
Worst-Case Input / Output Return Loss		12.73	10.88	dB	(2170.00~2200.00MHz)
Stop-band Attenuation (Referenced to 0.0 dB)	29	30.5		dB	DC~1980 MHz
	32	39.4			1980~2010 MHz
	20	32			2010~2110 MHz
	20	27			2260~2300 MHz
	29	34			2300~3500 MHz
	20	23			3500~6000 MHz
Terminating Source Impedance (Z_S)		50		Ω	
Temperature Coefficient of Frequency		-36		ppm/°C	

TEST CIRCUIT:

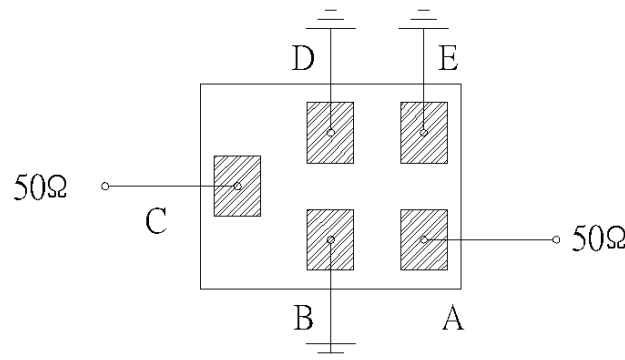

Surface Mount 2185.00MHz SAW Filter

AFS14A30-2185.00-T2



RoHS
Compliant

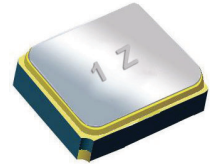

1.4 x 1.1 x 0.7 mm

OUTLINE DIMENSIONS:

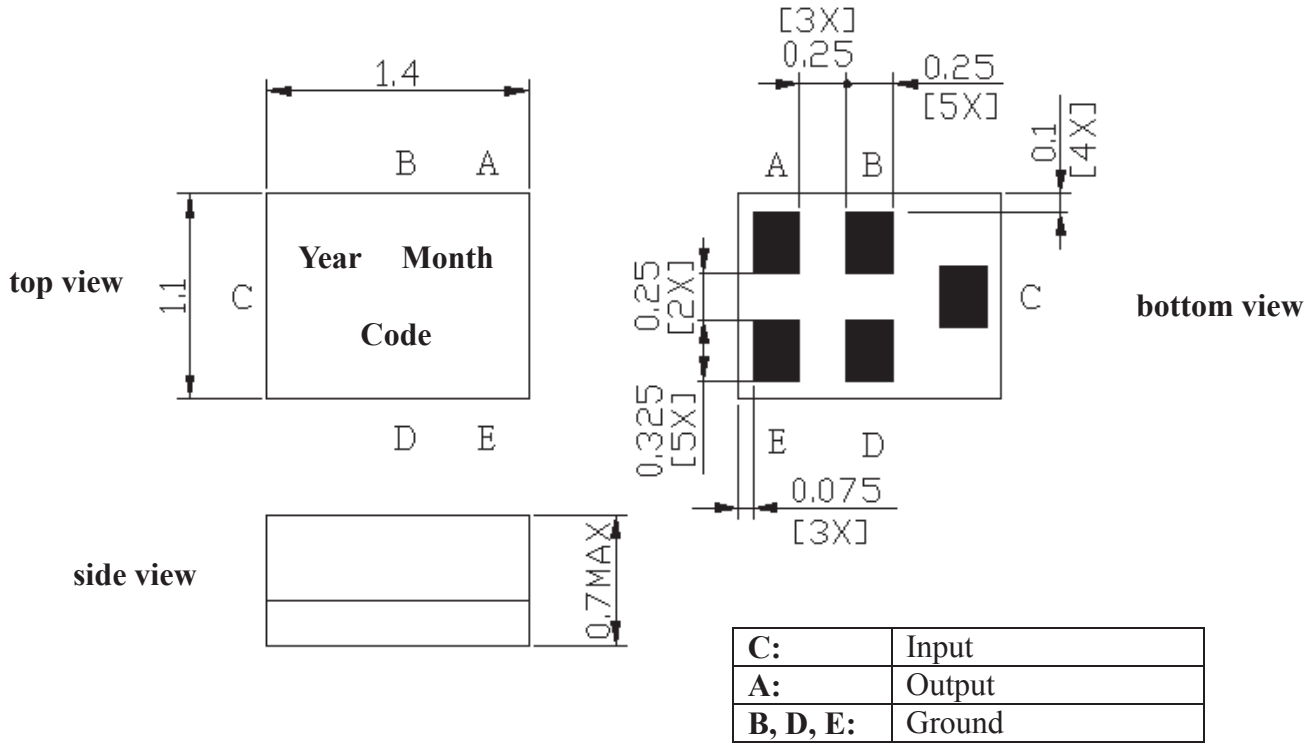

*All Dimensions are in mm

Recommended Land Pattern:

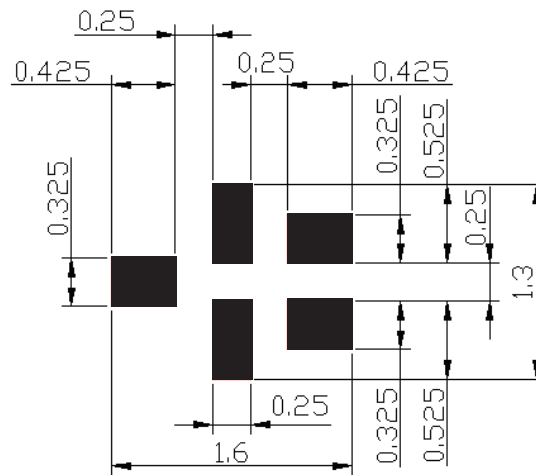

■ : Land Pattern
Unit : mm

Surface Mount 2185.00MHz SAW Filter

AFS14A30-2185.00-T2



RoHS
Compliant

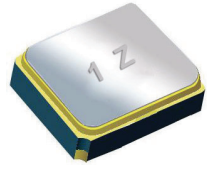

1.4 x 1.1 x 0.7 mm

FREQUENCY CHARACTERISTICS:

Filter Frequency Response (*Narrowband*)



Filter Frequency Response (*Wideband*)

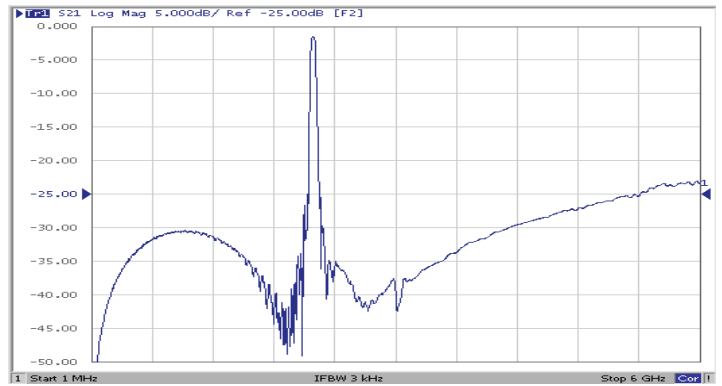
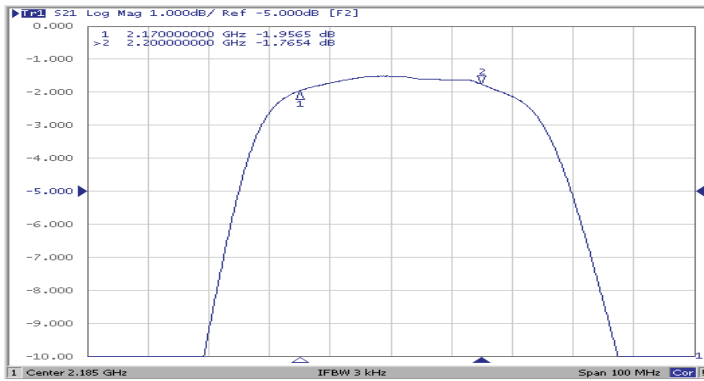

REFLECTION FUNCTIONS:

S11

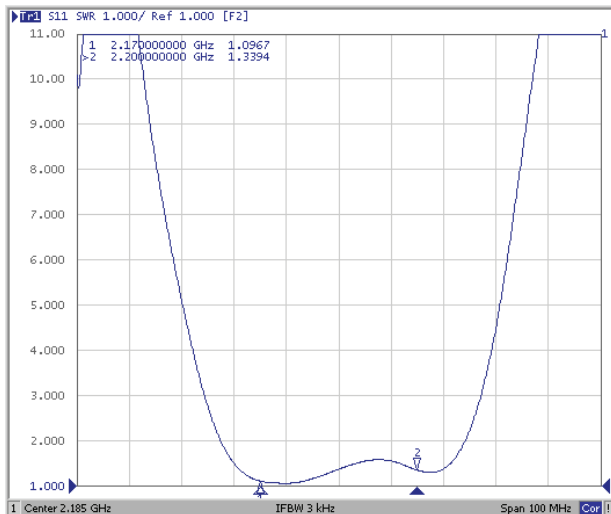

S22

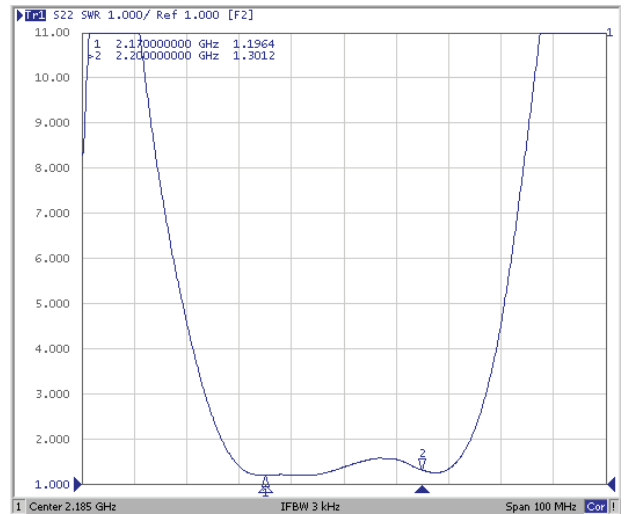

Surface Mount 2185.00MHz SAW Filter

AFS14A30-2185.00-T2



RoHS
Compliant

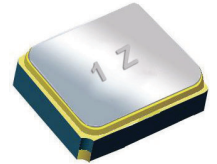

1.4 x 1.1 x 0.7 mm

REFLOW PROFILE:

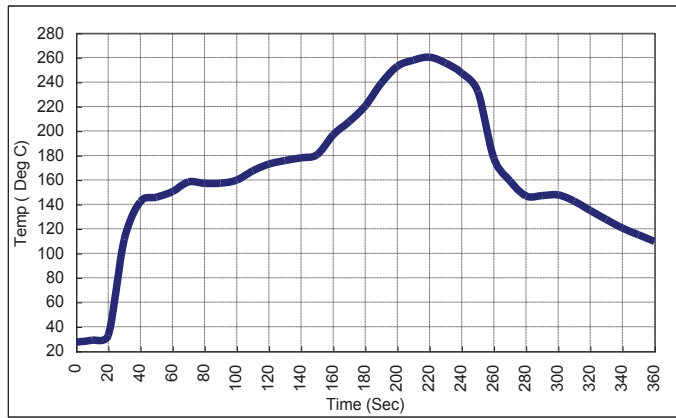

PACKAGING: 2000 Units/Reel

Reel Count : 7" = 2k units

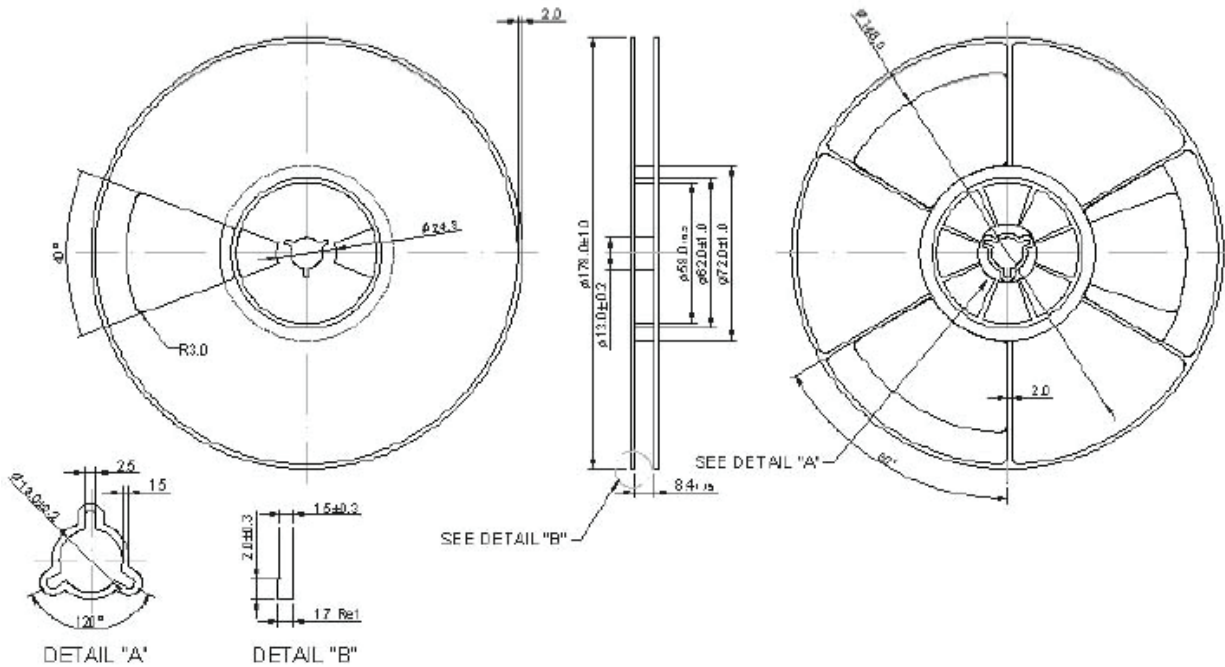

ATTENTION: Abracon Corporation's products are COTS – Commercial-Off-The-Shelf products; suitable for Commercial, Industrial and, where designated, Automotive Applications. Abracon's products are not specifically designed for Military, Aviation, Aerospace, Life-dependant Medical applications or any application requiring high reliability where component failure could result in loss of life and/or property. For applications requiring high reliability and/or presenting an extreme operating environment, written consent and authorization from Abracon Corporation is required. Please contact Abracon Corporation for more information.

ABRACON IS
ISO 9001:2008
CERTIFIED



Visit www.abracon.com for Terms & Conditions of Sale
30332 Esperanza, Rancho Santa Margarita, California 92688
tel 949-546-8000 | fax 949-546-8001 | www.abracon.com

Revised: 07.23.12