

# Fast Switching SCR T7SH\_60

600A Avg.  
(950 RMS)  
Up to 800 Volts  
20-40  $\mu$ s

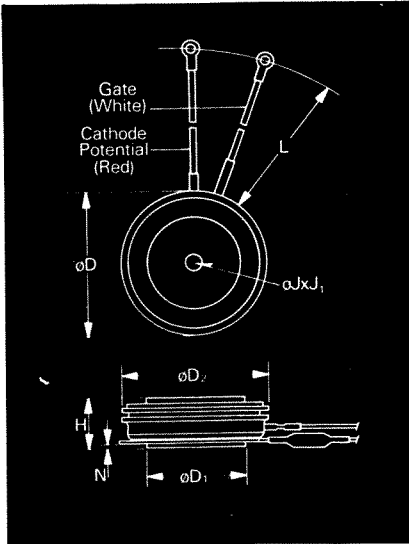

Symbol	Inches		Millimeters	
	Min.	Max.	Min.	Max.
$\phi D$	1.850	1.900	45.72	48.26
$\phi D_1$	1.140	1.180	28.96	29.97
$\phi D_2$	1.760	1.850	44.70	46.99
H	.545	.605	13.84	15.37
$\phi J$	.135	.145	3.43	3.68
$J_1$	.072	.082	1.83	2.08
L	7.75	8.50	196.85	215.90
N	.025		.64	

Creep Distance—.41 in. min. (10.41 mm).  
Strike Distance—.35 in. min. (8.89 mm).  
Finish-Nickel Plate.  
Approx. Weight—4 oz. (113 g.)  
1. Dimension "H" is a clamped dimension.

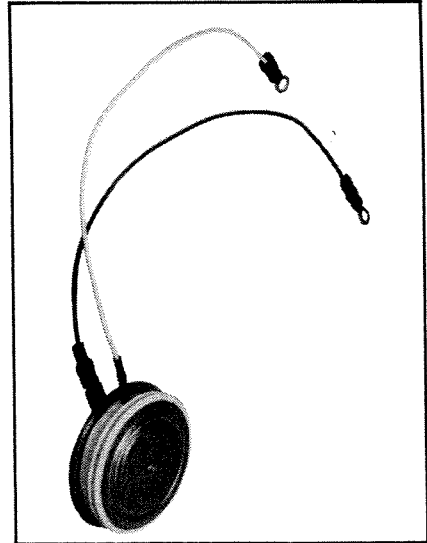

## T7S Outline

### Features:

- Interdigitated, di/namic Gate structure
- Hard Commutation Turn-Off
- Forward Blocking Voltage Capabilities to 800 Volts
- Low Switching Losses at High Frequency
- Soft Commutation (Feedback Diode) Testing Available
- High di/dt with soft gate control

### Applications:

- Induction Heating
- Transportation
- Inverters

## Ordering Information

Type	Voltage		Current		Turn-off		Gate current		Leads		
Code	V <sub>DRM</sub> and V <sub>RRM</sub> (V)	Code	I <sub>T(av)</sub> (A)	Code	t <sub>q</sub> usec	Code	I <sub>GT</sub> (ma)	Code	Case	Code	
T7SH	100	01	600	60	20	6	150	4	T7S	DN	
	200	02			25						8
	300	03			30						5
	400	04			40						4
	500	05									
	600	06									
	700	07									
	800	08									

## Example

Obtain optimum device performance for your application by selecting proper Order Code.

Type T7SH rated at 600A average with V<sub>DRM</sub> = 400V  
I<sub>GT</sub> = 150 ma, t<sub>q</sub> = 30  $\mu$ sec max. and leads—order as:

Type	Voltage	Current	Turn Off	Gate Current	Leads
T 7 S H	0 4	6 0	5	4	D N

**600A Avg.  
(950 RMS)  
Up to 800 Volts  
20-40  $\mu$ s**

**Fast Switching  
SCR  
T7SH\_60**

**Voltage** ①

**Blocking State Maximums** ( $T_J = 125^\circ\text{C}$ )

	Symbol	100	200	300	400	500	600	700	800
Repetitive peak forward blocking voltage, V	$V_{DRM}$	100	200	300	400	500	600	700	800
Repetitive peak reverse voltage, V	$V_{RRM}$	100	200	300	400	500	600	700	800
Non-repetitive transient peak reverse voltage, $t \leq 5.0$ msec, V	$V_{RSM}$	200	300	400	500	600	700	800	900
Forward leakage current, mA peak	$I_{DRM}$	← 35 →							
Reverse leakage current, mA peak	$I_{RRM}$	← 35 →							

**Current**

**Conducting State Maximums**  
( $T_J = 125^\circ\text{C}$ )

	Symbol	T7SH_60
RMS forward current, A	$I_T(\text{rms})$	950
Ave. forward current, A	$I_T(\text{av})$	600
One-half cycle surge current <sup>②</sup> , A	$I_{TSM}$	9000
$I^2t$ for fusing (for times $\geq 8.3$ ms) A <sup>2</sup> sec.	$I^2t_f$	338,000
Forward voltage drop at $I_{TM} = 1500\text{A}$ and $T_J = 25^\circ\text{C}$ , V	$V_{TM}$	1.55
Min. repetitive $di/dt$ ①④⑤ A/ $\mu$ sec	$di/dt$	600

**Switching**

( $T_J = 25^\circ\text{C}$ )

	Symbol	
Max. turn-off time, $I_T = 400\text{A}$ , $T_J = 125^\circ\text{C}$ $t_p = 100$ $\mu$ sec, $di/dt = 25$ A/ $\mu$ sec., reapplied $dv/dt = 200\text{V}/\mu$ sec. linear to 0.8 $V_{DRM}$ , $\mu$ sec. ③④	$t_q$	20 to 40
Typ. delay time, $I_{TM} = 1000\text{A}$ $T_D = .8 V_{DRM}$ ⑤, $\mu$ sec	$t_d$	.5
Typ turn-on-time $I_{TM} = 1000\text{A}$ , $\mu$ sec	$t_{on}$	3.0
Min. critical $dv/dt$ exponential to .8 $V_{DRM}$ , $T_J = 125^\circ\text{C}$ , V/ $\mu$ sec ③④	$dv/dt$	300
Min. $di/dt$ , non-repetitive, A/ $\mu$ sec ①④⑤	$di/dt$	1200

**Gate**

**Maximum Parameters**  
( $T_J = 25^\circ\text{C}$ )

	Symbol	
Gate current to trigger at $V_D = 12\text{V}$ , mA	$I_{GT}$	150
Gate voltage to trigger at $V_D = 12\text{V}$ , V	$V_{GT}$	3
Non-triggering gate voltage, $T_J = 125^\circ\text{C}$ , and rated $V_{DRM}$ , V	$V_{GDM}$	.25
Peak forward gate current, A	$I_{GTM}$	4
Peak reverse gate voltage, V	$V_{GRM}$	5
Peak gate power, Watts	$P_{GM}$	16
Average gate power, Watts	$P_{G(av)}$	3

**Thermal and Mechanical**

	Symbol	
Min., Max. oper. junction temp., $^\circ\text{C}$	$T_J$	-40 to +125
Min., Max. storage temp., $^\circ\text{C}$	$T_{stg}$	-40 to +150
Max. mounting force, lb. ①		2000 to 2400
Thermal resistance <sup>①</sup> , double-side cooling, junction to case, $^\circ\text{C}/\text{Watt}$	$R_{\theta JC}$	.045
Case to sink, lubricated, $^\circ\text{C}/\text{Watt}$	$R_{\theta CS}$	.02

- ① Consult recommended mounting procedures.
- ② Applies for zero or negative gate bias.
- ③ Per JEDEC RS-397, 5.2.2.1.
- ④ With recommended gate drive.
- ⑤ Higher  $dv/dt$  ratings available, consult factory.
- ⑥ Per JEDEC standard RS-397, 5.2.2.6.
- ⑦ For operation with antiparallel diode, consult factory.

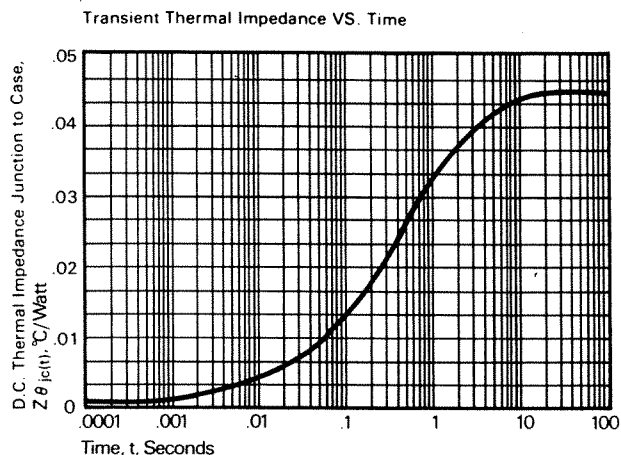
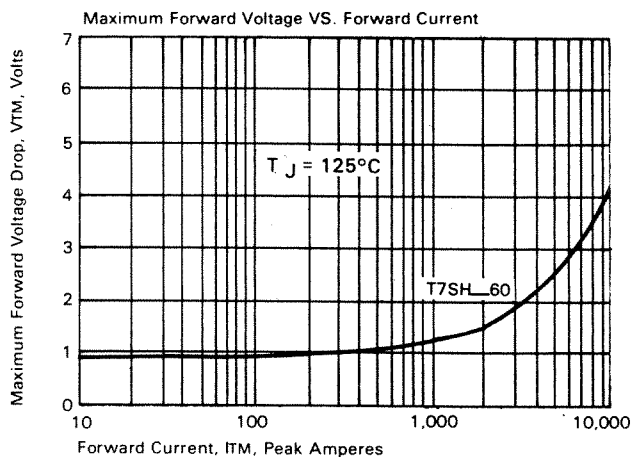

FAST SWITCHING  
THYRISTORS

# Fast Switching SCR T7SH\_60

600A Avg.  
(950 RMS)  
Up to 800 Volts  
20-40  $\mu$ s

## Sinusoidal Current Data

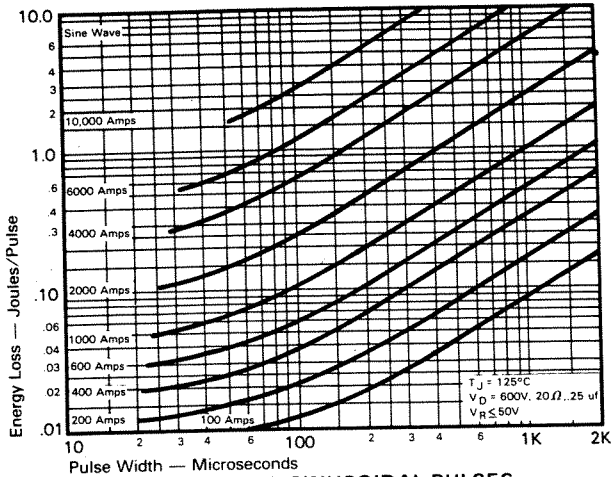

## Trapezoidal Wave Current Data

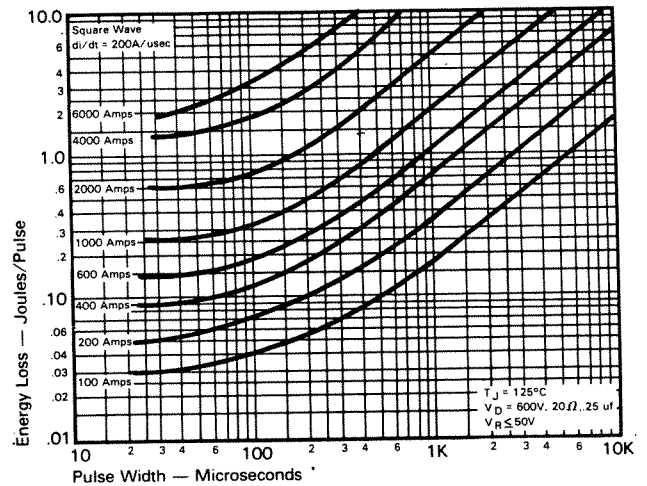
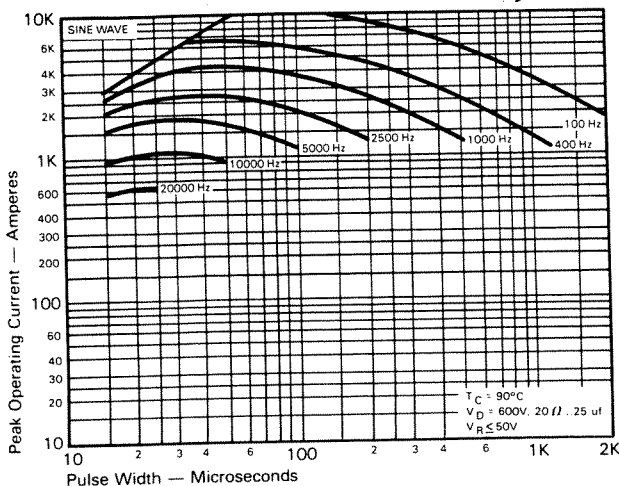
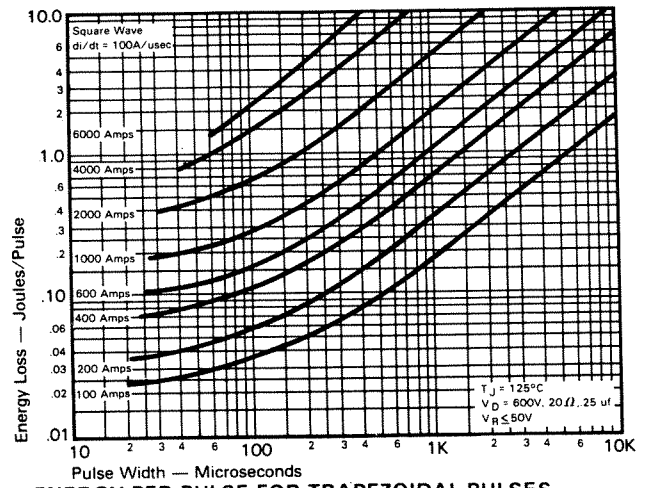
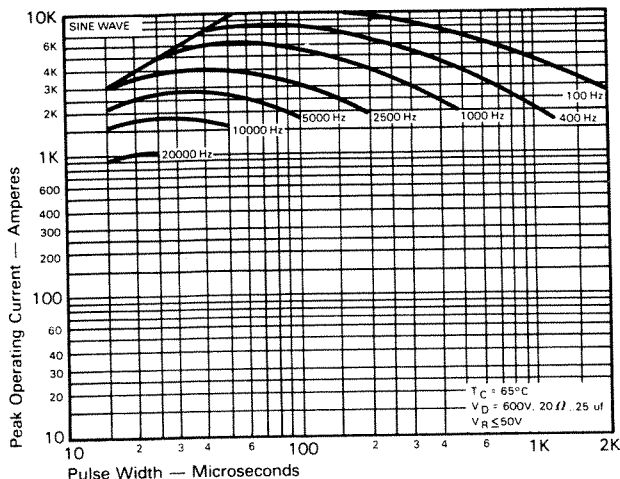
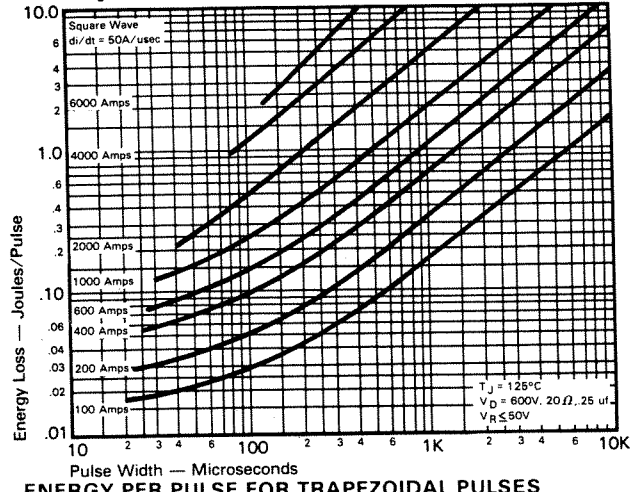

FAST SWITCHING  
THYRISTORS

**600A Avg.  
(950 RMS)  
Up to 800 Volts  
20-40  $\mu$ s**

**Fast Switching  
SCR  
T7SH\_60**

**Trapezoidal Wave Current Data  
( $T_C = 65^\circ\text{C}$ )**

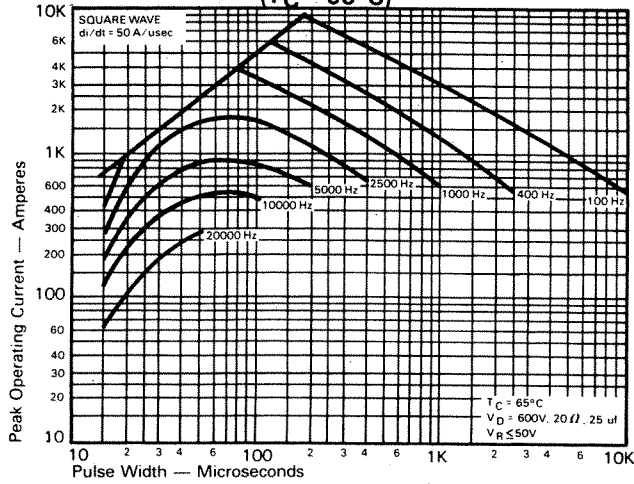

**MAXIMUM ALLOWABLE PEAK ON-STATE CURRENT vs. PULSE WIDTH ( $di/dt = 50\text{A/usec}$ )**

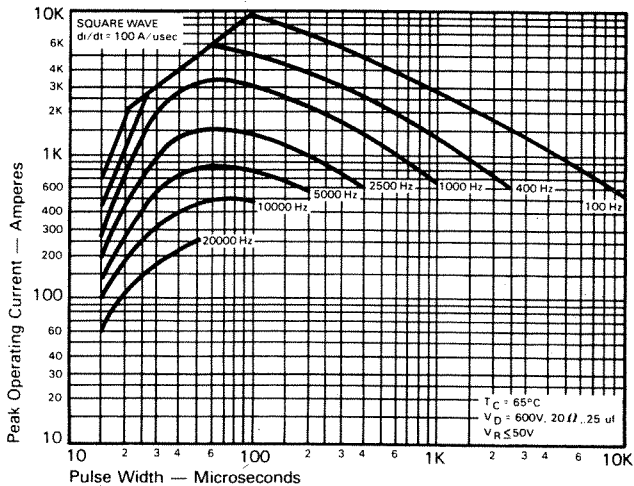

**MAXIMUM ALLOWABLE PEAK ON-STATE CURRENT vs. PULSE WIDTH ( $di/dt = 100\text{A/usec}$ )**

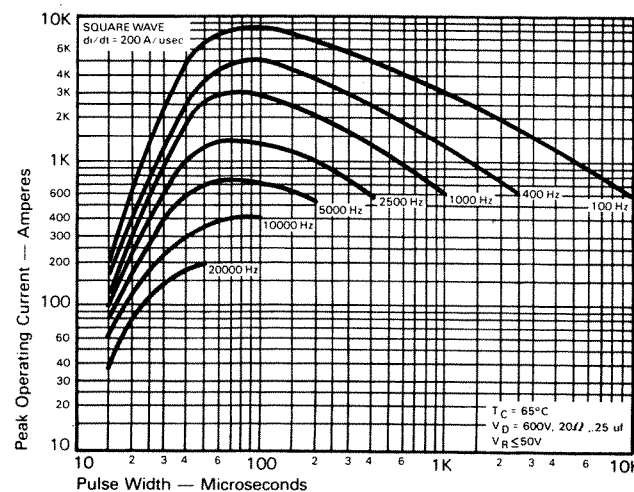

**MAXIMUM ALLOWABLE PEAK ON-STATE CURRENT vs. PULSE WIDTH ( $di/dt = 200\text{A/usec}$ )**

**Trapezoidal Wave Current Data  
( $T_C = 90^\circ\text{C}$ )**

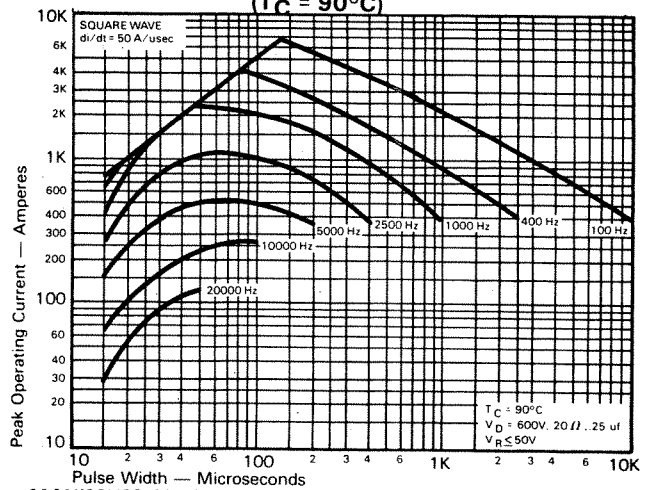

**MAXIMUM ALLOWABLE PEAK ON-STATE CURRENT vs. PULSE WIDTH ( $di/dt = 50\text{A/usec}$ )**

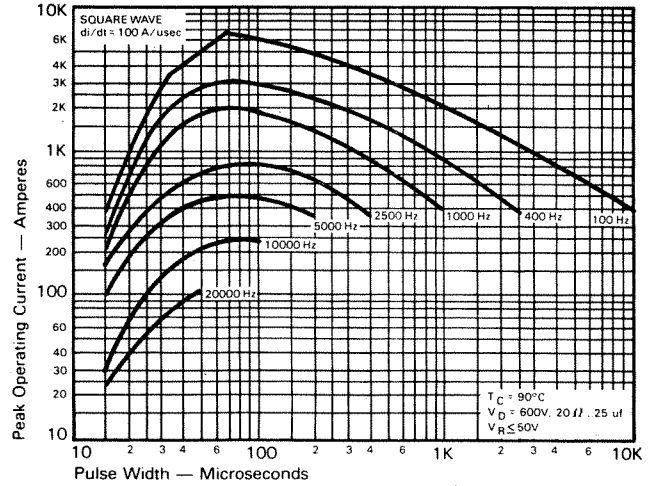

**MAXIMUM ALLOWABLE PEAK ON-STATE CURRENT vs. PULSE WIDTH ( $di/dt = 100\text{A/usec}$ )**

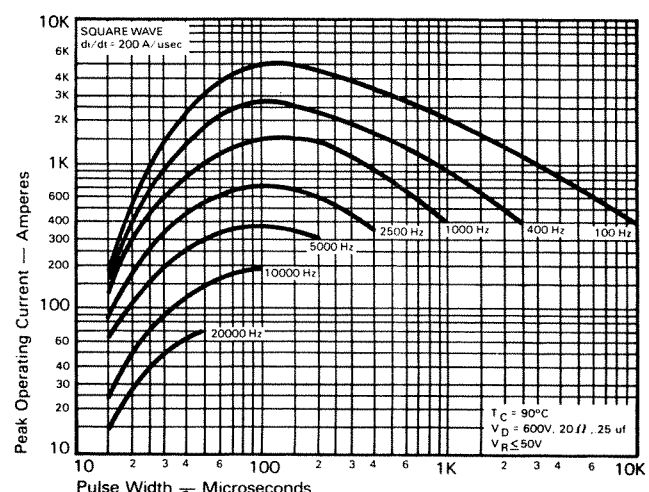

**MAXIMUM ALLOWABLE PEAK ON-STATE CURRENT vs. PULSE WIDTH ( $di/dt = 200\text{A/usec}$ )**

FAST SWITCHING THYRISTORS