

Powerex, Inc., 200 Hillis Street, Youngwood, Pennsylvania 15697-1800 (412) 925-7272
 Powerex, Europe, S.A. 428 Avenue G. Durand, BP107, 72003 Le Mans, France (43) 41.14.14

Phase Control SCR
 300 Amperes Average
 1300 Volts

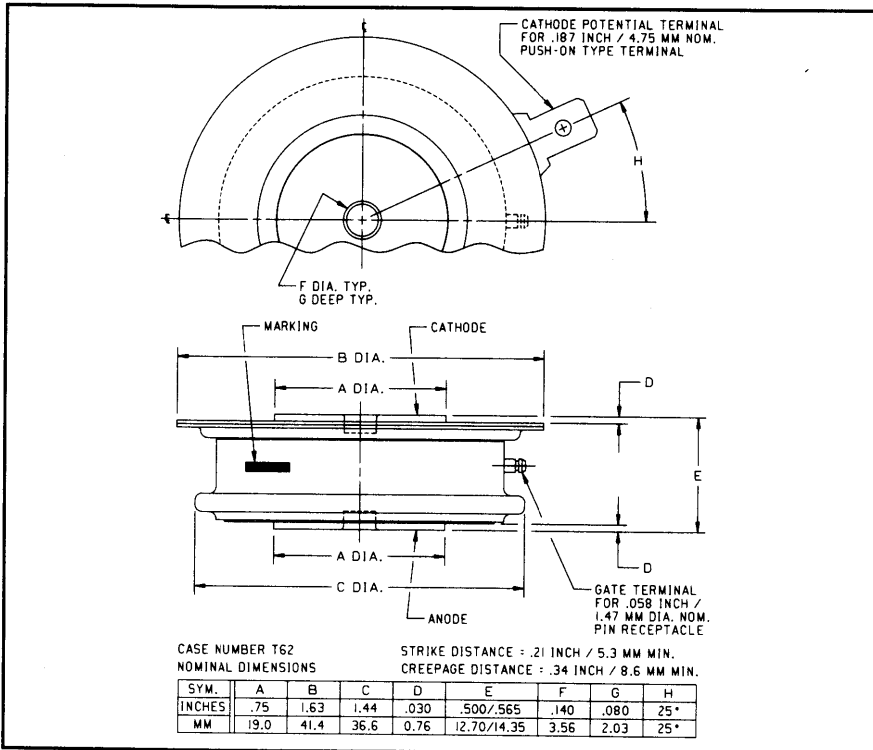

C380__X555 (Outline Drawing)

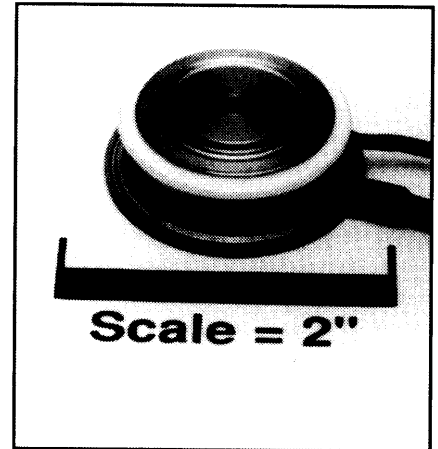

C380__X555 Phase Control SCR
 300 Amperes Average, 1300 Volts

Ordering Information:

Select the complete nine or ten digit part number you desire from the table, i.e. C380PCX555 is a 1300 Volt, 300 Ampere Phase Control SCR.

Type	Voltage		Current
	V _{DRM}	V _{RRM} Code	I _{T(av)}
C380__X555	400	D	300
	600	M	
	800	N	
	1000	P	
	1200	PB	
	1300	PC	

Description:

Powerex Silicon Controlled Rectifiers (SCR) are designed for phase control applications. These are all-diffused, Press-Pak (Pow-R-Disc) devices employing the field-proven amplifying (di/namic) gate.

Features:

- Low On-State Voltage
- High di/dt
- High dv/dt
- Hermetic Packaging
- Excellent Surge and I²t Ratings
- High Temperature Operation

Applications:

- Power Supplies
- Battery Chargers
- Motor Control

C380_X555
 Phase Control SCR
 300 Amperes Average, 1300 Volts

Absolute Maximum Ratings

	Symbol	C380_X555	Units
RMS On-State Current @ $T_C = 85^\circ\text{C}$	$I_{T(RMS)}$	450	Amperes
Average On-State Current @ $T_C = 85^\circ\text{C}$	$I_{T(av)}$	300	Amperes
Peak One-Cycle Surge (Non-Repetitive) On-State Current (60Hz)	I_{TSM}	3200	Amperes
Peak One-Cycle Surge (Non-Repetitive) On-State Current (50Hz)	I_{TSM}	2900	Amperes
Critical Rate-of-Rise of On-State Current (Non-Repetitive)	di/dt	600	Amperes/ μs
Critical Rate-of-Rise of On-State Current (Repetitive)	di/dt	300	Amperes/ μs
I^2t (for Fusing), 8.3 milliseconds	I^2t	42,000	A^2sec
Peak Gate Power Dissipation	P_{GM}	10	Watts
Average Gate Power Dissipation	$P_{G(av)}$	2	Watts
Storage Temperature	T_{STG}	-40 to 150	$^\circ\text{C}$
Operating Temperature	T_J	-40 to 150	$^\circ\text{C}$
Mounting Force		720 to 880	lb.
Mounting Force		3.2 to 3.92	kN

Electrical and Thermal Characteristics

Characteristics	Symbol	Test Conditions	C380_X555	Units
Voltage—Blocking State Maximums				
Forward Leakage, Peak	I_{DRM}	$T_J = 150^\circ\text{C}, V = V_{DRM}$	45	mA
Reverse Leakage, Peak	I_{RRM}	$T_J = 150^\circ\text{C}, V = V_{RRM}$	45	mA
Current—Conducting State Maximums				
Peak On-State Voltage	V_{TM}	$I_{TM} = 1500\text{A Peak}, T_C = 25^\circ\text{C}$	2.85	Volts
Switching				
Typical Turn-Off Time	t_q	$T_J = +150^\circ\text{C}, I_{TM} = 250$ Amperes, $V_R = 50$ Volts Minimum, V_{DRM} (Reapplied), Rate-of-Rise of Reapplied Off-State voltage = 20 Volts/ μsec (Linear) Gate Bias During Turn-off Interval = 0 Volts, 100 Ω . Duty Cycle $\leq 0.01\%$	75	μsec
Typical Delay Time	t_d	$T_C = +25^\circ\text{C}, I_T = 100$ Adc, $V_{DRM} = \text{Rated}$ Gate Supply: 10 Volt Open Circuit, 25 ohm, 0.1 μsec maximum rise time	1.0	μsec
Min. Critical dv/dt exponential to V_{DRM}	dv/dt	$T_J = 150^\circ\text{C}, \text{Gate Open}$	200	V/ μsec
Thermal				
Maximum Thermal Resistance, double sided cooling Junction to Case	$R_{\theta JC}$		0.095	$^\circ\text{C}/\text{Watt}$
Case to Sink, Lubricated	$R_{\theta CS}$		0.02	$^\circ\text{C}/\text{Watt}$
Gate—Maximum Parameters				
Gate Current to Trigger	I_{GT}	$T_C = 25^\circ\text{C}, V_D = 6\text{Vdc}, R_L = 3\Omega$	150	mA
Gate Voltage to Trigger	V_{GT}	$T_C = -40^\circ\text{C to } 150^\circ\text{C}, V_D = 6\text{Vdc}, R_L = 3\Omega$	3	Volts
Non-Triggering Gate Voltage	V_{GDM}	$T_J = 150^\circ\text{C}, R_L = 1000\Omega, \text{Rated } V_{DRM}$	0.15	Volts
Peak Forward Gate Current	I_{GTM}		10	Amperes
Peak Reverse Gate Voltage	V_{GRM}		5	Volts

Powerex, Inc., 200 Hillis Street, Youngwood, Pennsylvania 15697-1800 (412) 925-7272
 Powerex, Europe, S.A. 428 Avenue G. Durand, BP107, 72003 Le Mans, France (43) 41.14.14

C380_X555
Phase Control SCR
 300 Amperes Average, 1300 Volts

MAXIMUM ON-STATE CHARACTERISTICS

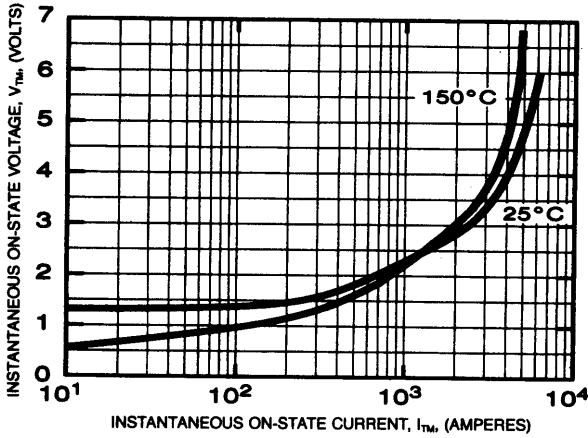

TRANSIENT THERMAL IMPEDANCE CHARACTERISTICS (JUNCTION TO CASE)

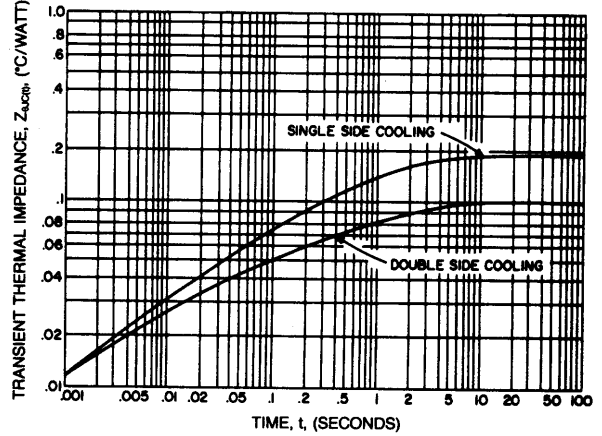

MAXIMUM ALLOWABLE CASE TEMPERATURE (SINUSOIDAL WAVEFORM)

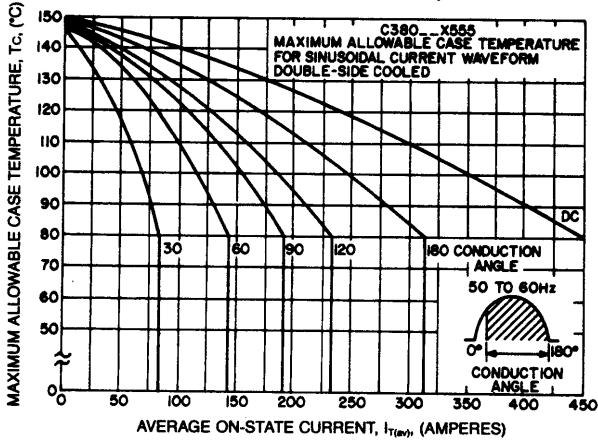

MAXIMUM ON-STATE POWER DISSIPATION (SINUSOIDAL WAVEFORM)

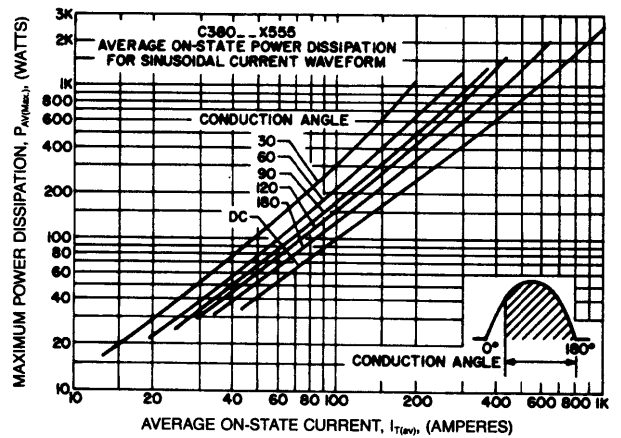

MAXIMUM ALLOWABLE CASE TEMPERATURE (RECTANGULAR WAVEFORM)

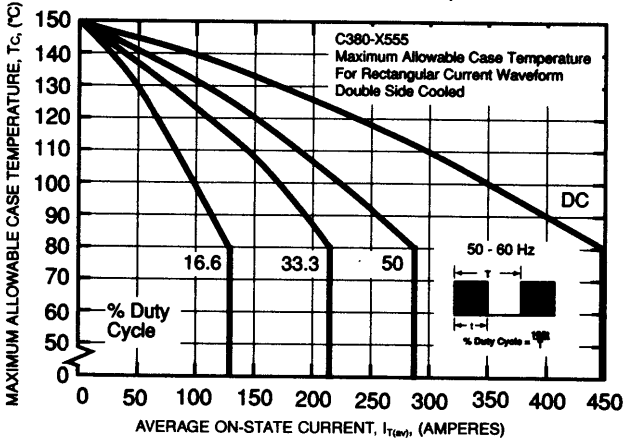

MAXIMUM ON-STATE POWER DISSIPATION (RECTANGULAR WAVEFORM)

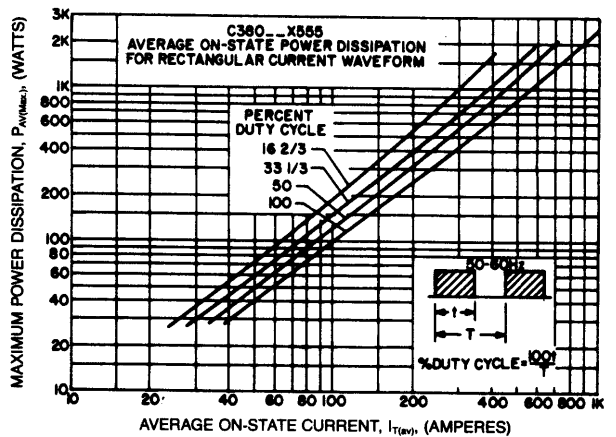

Powerex, Inc., 200 Hillis Street, Youngwood, Pennsylvania 15697-1800 (412) 925-7272
 Powerex, Europe, S.A. 428 Avenue G. Durand, BP107, 72003 Le Mans, France (43) 41.14.14

C380_X555
 Phase Control SCR
 300 Amperes Average, 1300 Volts

MAXIMUM ALLOWABLE CASE TEMPERATURE (SINUSOIDAL WAVEFORM)

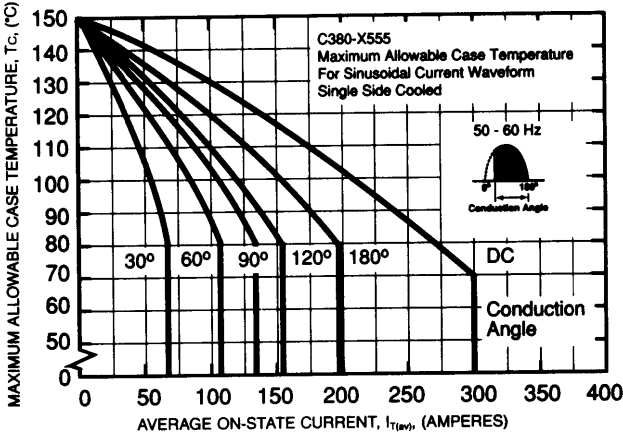

MAXIMUM ALLOWABLE CASE TEMPERATURE (RECTANGULAR WAVEFORM)

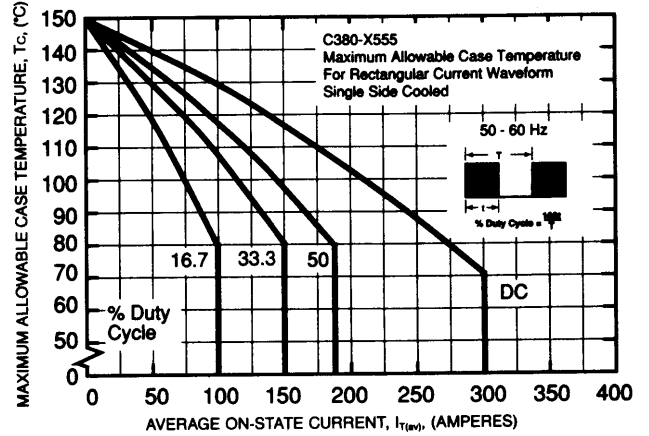

SUB-CYCLE SURGE AND I^2t RATINGS (RATED LOAD CONDITIONS)

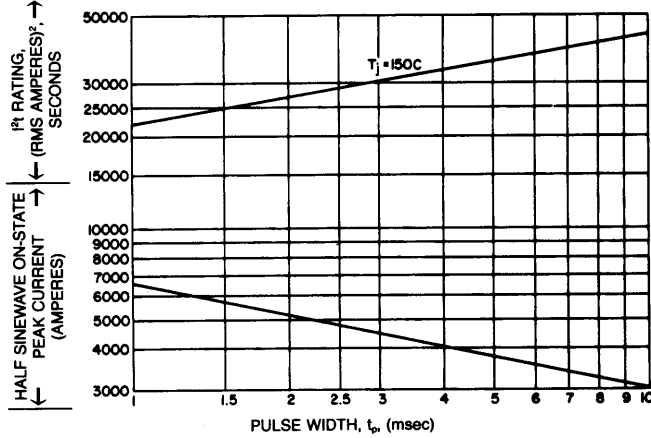

MAXIMUM ALLOWABLE SURGE ON-STATE CURRENT (NON-REPETITIVE)

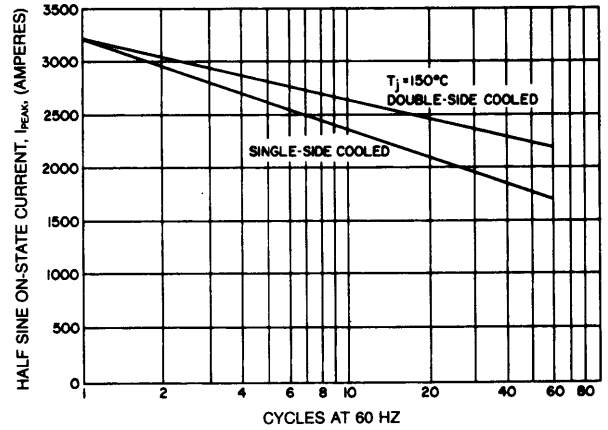

GATE CHARACTERISTICS

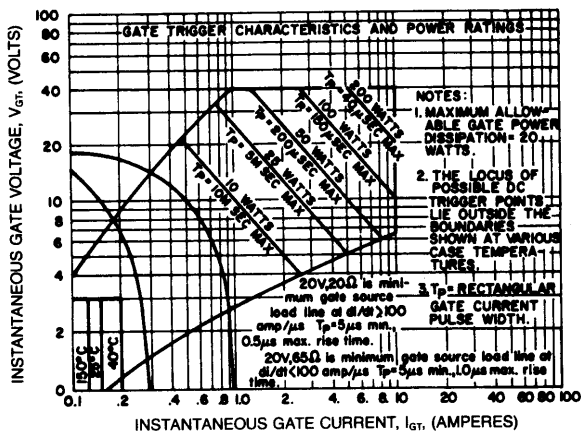

- NOTES:
 1. Maximum allowable gate power dissipation = 2 watts.
 2. The locus of possible DC trigger points lie outside the boundaries shown at various case temperatures.
 3. T_p = Rectangular Gate Current Pulse Width.