



End-to-end embedded power

Embedded power

Who we are

At ABB, we help our data center, computing, communications and digital content-provider customers wrestle with the exponential and insatiable demand for ever-increasing data, communications and processing capacity.

Our customers challenge us to efficiently and reliably power increasing capacity, and to quickly scale better and smarter data infrastructures with power solutions that keep their energy costs in check and ensure that data and applications flow 24x7.

What we do

Embedded power

- Products for AC-DC OEM embedded power for datacom, telecom, medical and industrial applications.
- Products for DC-DC OEM conversion for board-mounted power applications in communications, computing, storage, industrial, medical and military markets.
- Full custom capabilities in both AC-DC and DC-DC product lines.

Power switching

- Products for emergency standby, back-up power supply management and spike or surge protection, plus installation and maintenance services for markets including data centers, hospitals, telecommunications, financial institutions, transportation and industrial applications.

Uninterruptible Power Supplies (UPS)

- Products and services to provide a continuous supply of power and conditioning for mission-critical applications, plus global installation and maintenance services in markets including data centers, hospitals, financial institutions, telecommunications networks, wind energy, transportation and industrial.

DC energy systems

- Solutions for telecommunications, wireless and cable broadband service providers that leverage our extensive experience in turnkey

01

ABB brings end-to-end power solutions for a variety of markets including data centers,

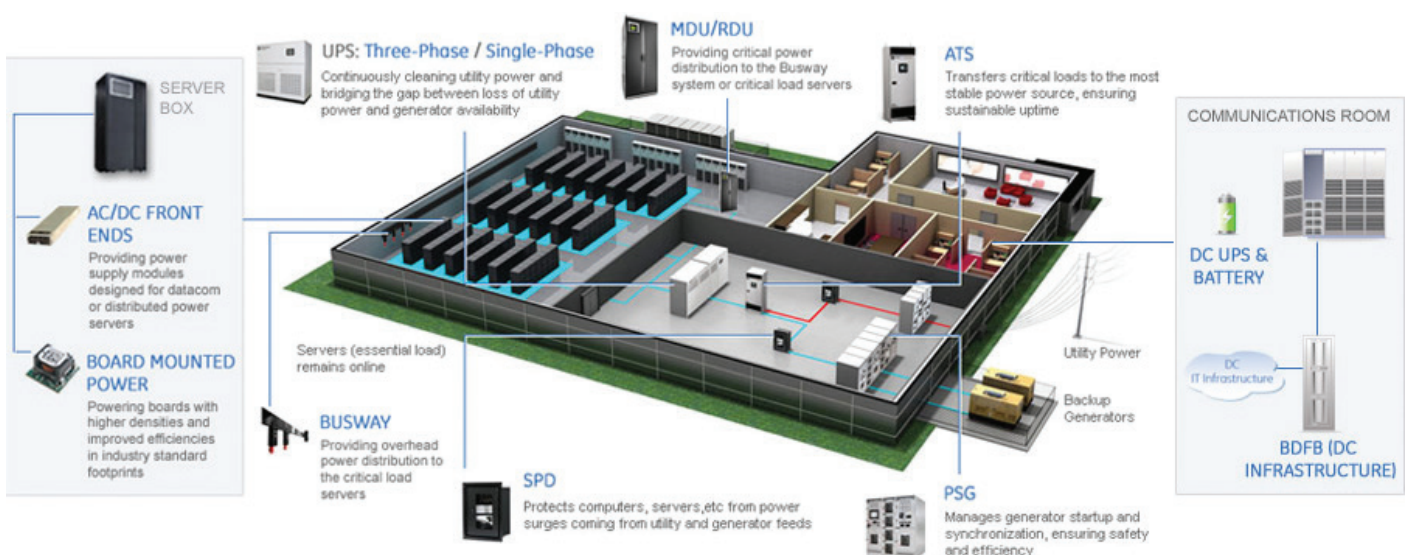

Total power solution

ABB provides end-to-end power solutions that offer size, efficiency and cost advantages while reducing risk with standards-based power components.

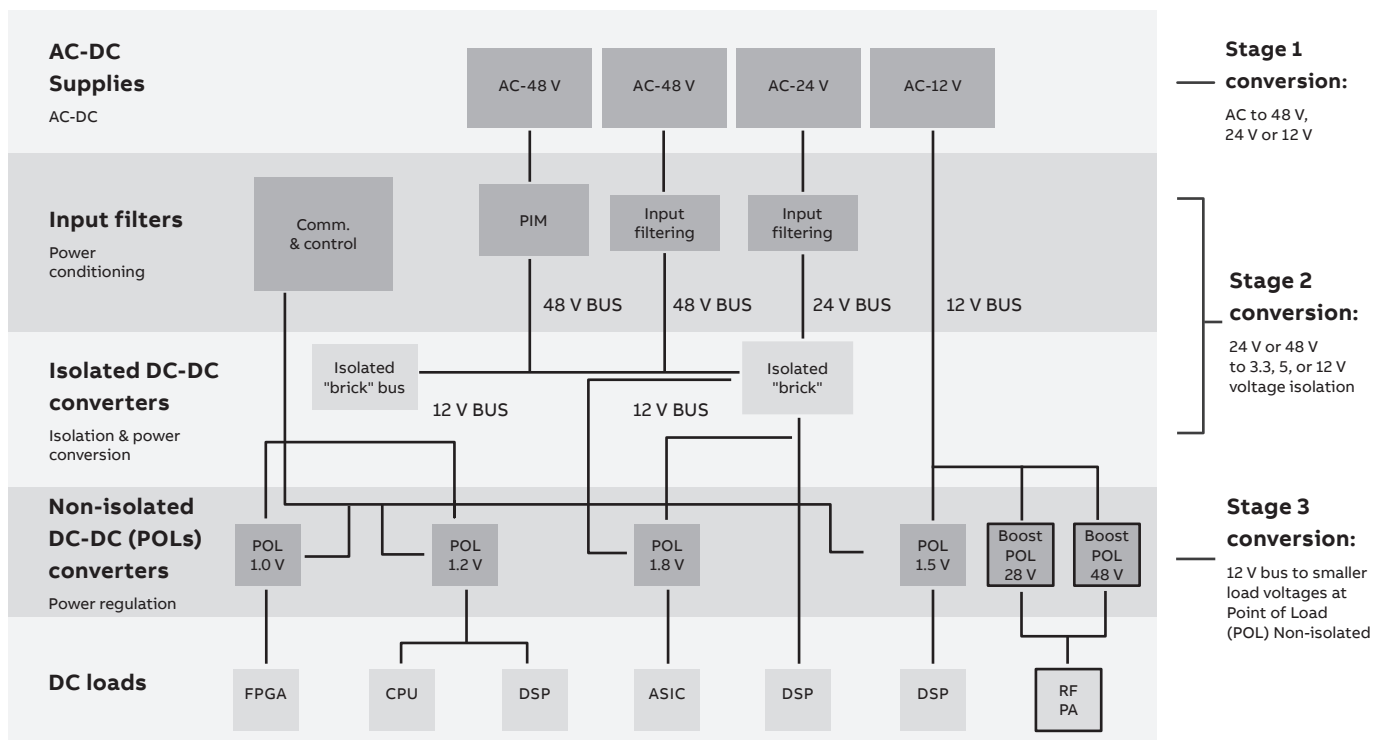

Distributed Power Architecture (DPA)

- The Distributed Power Architecture (DPA) is commonly used on today's circuit pack designs. The DPA has replaced multiple isolated power supplies with one single power supply that feeds multiple point of load (POL) converters. The DPA has brought with it the benefits of lower cost, weight, and space along with a better quality of power. Shown above is a typical DPA architecture.
- In Stage 1 of power conversion, an AC-DC power supply is used to convert a line voltage to a DC bus voltage of 48 V, 24 V, or 12 V to the circuit pack.
- If 48 or 24 V is fed to the circuit pack, the power rail is then converted to 12 V or 5 V through an isolated DC-DC converter. This is what we call stage 2 conversion. As a side note, if 12 V is fed to the circuit pack as shown on the right

side of the circuit pack, the isolated converter used in Stage 2 is not required. Conversion can proceed directly to Stage 3.

- Stage 3, the final conversion stage, is used to reduce the 12 V or 5 V bus to the various voltages required to drive the individual semiconductor loads.
- Total efficiency is the product of efficiency from each stage multiplied together: (Stage 2) 94% * (Stage 3) 93% = 89% total efficiency.
- DPA is valuable because:
 - It provides customers with standard product solutions.
 - It provides high-efficiency solutions that are competitive with older, single-stage systems.
 - It provides greater system flexibility to mix and match load voltages from a single voltage bus.

See how our line of embedded power solutions fits your design needs

Total cost of ownership

ABB products and solutions create AC-DC and DC-DC power solutions that give back valuable printed circuit board and server cabinet real estate to system designers.

In communications, data center and super computing markets, where exponential growth in processing capacity is matched with growing power requirements, we engineer many of the industry's most compact and efficient power solutions—designed to take advantage of unusable board or cabinet space.

Table of contents

007–011	Vertical industry solutions
012–016	Industrial products
017–018	High-voltage DC power family
019–029	AC-DC and DC-DC power supplies
030–043	Isolated DC-DC converters
044–052	Non-isolated DC-DC (point-of-load) converters
053	Digital power solutions
054–055	Custom capabilities
056–057	Engineering resources and tools
058–063	Product matrices



Vertical industry solutions

ABB power solutions are used in thousands of applications across a broad array of global industries

- Data centers
- Integrated solutions
- Broadcasting
- Smart buildings
- Displays, lighting and signage
- Aerospace and aviation
- Industrial automation and process control
- Medical devices
- Instrumentation, test and measurement
- Robotics

Data centers

With close to half the total cost of power for a data center being utilized for cooling, the importance of utilizing power products that are highly efficient takes on an ever more critical role. Operators demand not only efficiency and density—they also require their power solutions to be smart. The ABB Total Efficiency* (TE) architecture reduces energy loss and lowers cooling costs, as well as addresses issues from the electrical service entrance to the building, all the way down to the point of loads on the motherboard. ABB offers true end-to-end consideration of power optimization based on our proven experience and expertise in batteries, power distribution, surge protection, DC energy systems, AC-DC power supplies, and DC-DC board-mounted power. Our goal is to deliver a solution that is safer, more reliable, and more energy efficient than alternatives from

our competitors.

Integrated solutions

Data center power infrastructure can be complex to integrate and optimize. Data centers can also consume a large amount of space requiring big amounts of power to be distributed across long distances. In short, the power solutions must be tightly integrated and work seamlessly with the infrastructure, the network and the data equipment to not only help reduce operating costs, but to also help conserve space.

Whatever the requirements, ABB engineers can help design a highly-efficient and integrated solution that serves the entire data center, not just portions. By engaging with ABB to integrate the entire solution, data center operators can be assured that care will be taken to make the entire data center efficient, not just the individual power conversion steps. For example, ABB can evaluate the entire power budget and help design solutions that reduce conversion steps that result in unnecessary energy loss. ABB can

Broadcasting

TV and radio transmitters are likely to be one of the more costly items that a typical station owns, not only in their initial purchase price, but also due to ongoing operational costs. The electrical power efficiency of the transmitter plays an important part in the overall total cost of ownership (TCO) equation. Early digital TV transmitters had a power efficiency in the 15% to 18% range. This means that a 10 kW transmitter consumed about 66 kW of electrical energy, converting only 10 kW of that energy to useful RF and 56 kW as waste heat. For digital television, several power amplifier techniques have been developed that dramatically improve efficiency. Broadcast manufacturing industries are taking important steps and investing in new technologies to improve efficiency and reduce the TCO for TV and radio transmission systems. As newer and more efficient solid state RF devices become available, they allow designers to integrate them with other energy-saving techniques to further improve overall efficiency. Today, advanced PA technology, along with more efficient power supplies, optimized cooling systems and other techniques, are combined for optimized solutions. Ongoing development will lead to even higher-efficiency transmission systems in the future.

Smart buildings

In many of today's smart buildings, power is being shifted from the devices that once required separate AC power to devices that can both communicate and be powered over a single Power over Ethernet (PoE) cable. Enterprise devices such as badge scanners, 802.11n wireless access points, laptops, RFIDs, pan-tilt-zoom security cameras, video phones and point-of-sale terminals take advantage of ABB's PoE rectifiers, the CP2000AC54TEP, CP2725AC54TEP and MPR0854FP. These rectifiers provide 48-volt power required for smart building systems. The new solutions have a highly-reliable, hot-pluggable and hot-swappable footprint and are easily integrated into switch architectures that support multiple redundant rectifiers on a common DC bus, in various redundancy schemes including N+1 or N+N arrangements. In addition, flexible communication interfaces allow the switch designer to choose the most effective way to communicate with the power supplies. Enterprise customers benefit from a solution specifically created for highly-redundant environments, thereby reducing operating and service costs.

- Building security systems
- Fire safety systems
- HVAC systems

- Video surveillance

Displays, lighting and signage

With the ever-increasing demand for more efficient lighting solutions, LED lighting requires both constant-voltage and constant-current for its products. ABB's power modules for lighting applications feature shielding from power disturbances, ruggedized designs, high efficiencies and high reliability in a small form factor. The open frame and conduction cooled fanless AC-DC rectifiers such as CLP0224, CCR0512 are also suitable for outdoor lighting and signage applications, as are the wide-input voltage ProLynx* Point of Load modules.

- Backlighting
- Digital signage
- Indoor lighting
- Stadium lighting



Aerospace and aviation

Electronics in the aviation industry are rapidly requiring increased capability and complexity while demanding a more compact design. Ranging from cockpit avionics and lighting systems to elaborate multimedia entertainment systems for commercial jets, the need for small, efficient, and reliable power electronics modules is critical. These new systems need a mixture of voltages and control frequencies. As design engineers continue to integrate more functionality into their innovative designs, the ability to support a complex mixture of output voltages will become even more important. Using standard, commercially-available power supplies yields space savings, simpler designs, and less cabling when the DC output is fed directly into the backplane as opposed to using an external power supply. ABB's SlimLynx* Point of Load modules provide industry-leading power density and efficiency in a slim and compact form factor.

- Cockpit avionics
- Navigation systems
- Aircraft control panels
- Lighting systems
- In-flight entertainment (IFE)



Industrial automation and process control

Industrial automation uses information technology and control systems to manage machinery, valves, actuators and assembly lines, therefore reducing the need for human intervention and eliminating costly errors. Power supplies for industrial automation and control applications require a wide operating temperature range and extended shock and vibration testing. ABB's power modules offer sequencing, reliability, and remote on/off facilities to ensure continuous efficient operation in the power design. Our rugged power supplies meet MIL STD 810G for extended shock and vibration testing, up to 50Grms, offer excellent thermal management up to 105°C, and maintain low ripple/noise operation. The industrial AC-DC rectifiers from ABB such as the CAR0424 and CLP0224 deliver 24 V as output voltage suited to operate valves and actuators, and work with the wide input ProLynx* Point of Load modules to simplify board design. ABB's Tranquell* DIN Rail Series Surge Protective Devices help minimize power-related problems by protecting sensitive automation control equipment from harmful transients.

- Conveyor systems
- Motor control applications
- Factory automation (PLCs)
- Switching systems
- Transportation / railway
- Remote monitoring equipment
- Security systems
- Human machine interface

Medical devices

Sophisticated power solutions for ultrasound, dialysis, and diagnostic equipment require stringent parameters such as low output ripple and EMI noise, which, if left unconditioned, can disrupt the performance and accuracy of the end equipment. These highly-sensitive systems require more sophisticated power solutions—a key strength for ABB. Given the sometimes long FDA approval cycles in the health-care industry, our expertise in powering medical products

provides solutions to complex system requirements, which enable designers to improve product cycle times while reducing their time-to-market. The DLynx* Point of Load modules efficiently power circuit board electronics and accelerate product development schedules.

- Laboratory and analytical
- Eye care equipment
- Medical imaging
- Dental equipment

Instrumentation, test and measurement

Test and measurement systems are ubiquitous in electronic devices and maximize the productivity of engineers and technicians responsible for packaged-part characterization in applications ranging from early device research through development, quality verification, and failure analysis. Automated test equipment systems are routinely used in electronics manufacturing operations, the semiconductor industry, and factory environments. ABB's DLynx* and DLynx II* Point of Load power modules provide the power designer the latest tools and performance for power, with key features such as increased current, increased accuracy, and extended PMBus™ command set.

- Semiconductor test equipment
- Automated test equipment
- Oscilloscopes
- Microscopes

Robotics

Power supplies for robotics applications require small size, high levels of shock and vibration resistance and a wide operating temperature range. A high degree of efficiency and reliability is also necessary. ABB's DLynx* and DLynx II* families provide some of the most compact Point of Load DC-DC converters available with outstanding performance, control, and reliability.

- Manufacturing systems
- Gantry robots
- Industrial robots
- Packaging systems
- Warehouse management

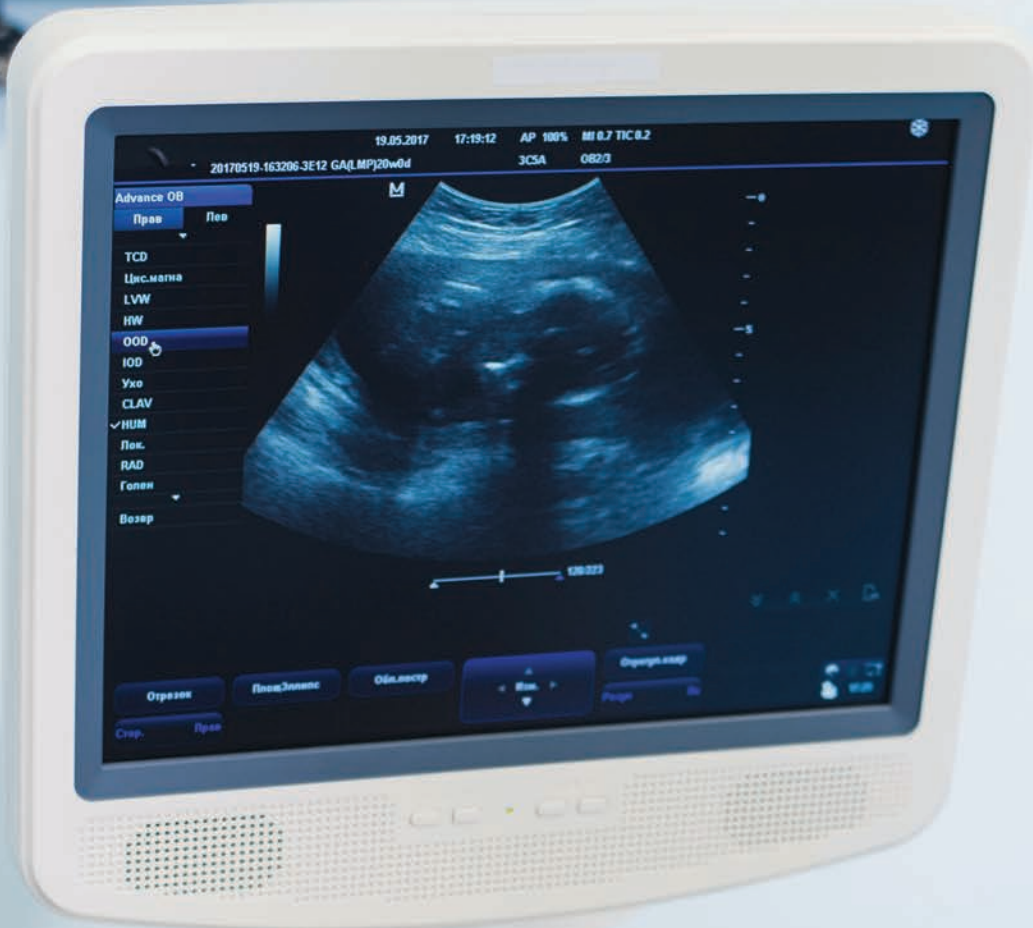

Industrial products

CC1600 (1600 W, 52 V out) AC-DC fanless, sealed, potted & conduction cooled

Features

- Compact form factor with 16 W/in³ density
- 11.52" (L) x 5.29" (W) x 1.83" (H) (includes connector length)
- Rugged for outdoor and indoor applications
- Standalone and mountable
- Input and output connector block for easy connections
- Efficiency greater than 94% (for high line)
- 1600 W from nominal 200-240 Vac @ 55 C baseplate
- 1200 W from nominal 120-120 Vac @ 45 C baseplate
- Output voltage programmable from 42 V-58 Vdc
- Floating output for positive and negative polarity
- DC-OK external LED signal
- Over-temperature, under voltage, over-voltage protections
- Remote ON/OFF control of the main output via RS485
- Precision measurement reporting of input/output voltage and current
- Power factor correction meets EN/IEC 61000-3-2 and EN60555-2
- Redundant, parallel operation with active load sharing
- UL, CSA C22.2, VDE/TUV compliance
- CE & RoHS2 compliant
- ESD Level 4: 8 KVcontact/15 KVair
- Lightning surge Level 4: 4 KVcommon/2 KVdiff



Comcode: CC1600AC52SXZ01A

Applications

- Outdoor lighting
- Telecom
- Broadcast
- Laser

CC3500

The CC3500AC54FB2 family of power supplies have an extremely wide programmable output voltage capability. Featuring high-density, fully-enclosed, fanless conduction-cooled packaging, it is designed for minimal space utilization and is highly expandable for future growth. This completely silent power supply incorporates both RS485 and dual-redundant I²C communications busses that allow it to be used in a broad range of applications.

Feature-set flexibility makes this power supply an excellent choice for applications requiring operation over a wide output-voltage range. Its robust design is intended for rugged applications where temperature extremes may be experienced. Electrical user interfaces are designed for extreme simplicity and quick installation.



New expanded output range!

Model	Input	Cooling	Input range(V)	V OUT	I OUT	Efficiency
CC3500AC53FB2	AC Rear, Blind Mate	Fanless Conduction	80-185 V 185-265 V	18-58 V	Low Line 28.3/28.9 A @ 52 V High Line 66/67.3 A @ 52 V Folds Back below 42 V	96%
CC3500AC52FB2-ES	AC Rear, Direct Wire	Fanless Conduction	80-185 V 185-265 V	18-58 V	Low Line 28.3/28.9 A @ 52 V High Line 66/67.3 A @ 52 V Folds Back below 42 V	96%

Features and benefits

- Conduction cooled fanless operation
- Rugged for temperature extremes
- Silent running
- Wide-range output
- Can be paralleled for load sharing
- Designed for adaptation to cold plate or heat sink
- Blind-mate version
- Simple screw terminal version
- Ability to charge batteries
- PMBus/I²C or RS485 communications capable
- High efficiency 95%+

Hornet voltage regulator

The Hornet family of non-isolated board-mounted switching regulators are easy to use, fully integrated power modules for demanding industrial conditions. With highly-accurate output voltage setting, high efficiency, exceptional power density, extended temperature range for extreme environments and proven high reliability, Hornet switching voltage regulators are well-suited for industrial applications.

The Hornet series includes step-down/buck regulators that deliver 11 to 108 W maximum power and step-up/boost



Step down through hole

Model	Input range(V)	Output range(V)	Temp. range / Mil. St 810F	Max power (W)	Max current (UP TO) (A)	Footprint (MM)	Efficiency (up to)
IND016	12 V±20%	0.6-5.5	-40 - 105°C / 40 G	16.5	3	12.2x12.2	94%
IND033	12 V±20%	0.6-5.5	-40 - 105°C / 40 G	33	6	12.2x12.2	94%
IND066	12 V±20%	0.6-5.5	-40 - 105°C / 40 G	66	12	12.2x12.2	95%
IND072	12 V±20%	0.6-3.3	-40 - 105°C / 40 G	72.6	20	12.2x12.2	94%
IND080	12 V±20%	0.6-2.0	-40 - 105°C / 40 G	80	40	13.5x33	92%
IND027W	12 V±20%	3.0-9.0	-40 - 105°C / 40 G	27	3	11.4x20.3	96%
IND045W	12 V±20%	3.0-9.0	-40 - 105°C / 40 G	45	5	11.4x20.3	94%
IND108W	12 V±20%	3.0-9.0	-40 - 105°C / 40 G	108	12	13.5x33	95%
IND027XW	24 V±20%	3.0-18.0	-40 - 105°C / 40 G	27	3	11.4x20.3	96%
IND045XW	24 V±20%	3.0-18.0	-40 - 105°C / 40 G	45	5	11.4x20.3	96%
IND108XW	24 V±20%	3.0-18.0	-40 - 105°C / 40 G	108	12	13.5x33	97%

Step down through hole

Model	Input range(V)	Output range(V)	Temp. range / mil. st 810F	Max power (W)	Max current (A)	Footprint (MM)	Efficiency (up to)
IND011SIP	12 V±15%	0.6-5.5	-40 - 85°C	11	10	8.1x10.4	93%
IND060SIP	12 V±15%	0.6-5.5	-40 - 85°C	60	2	8.4x10.4	93%

Boost / step up SMT

Model	Input range(V)	Output range(V)	Temp. range / mil. st 810F	Max power (W)	Max current (A)	Footprint (MM)	Efficiency (up to)
IND065BHV	12 V±20%	32-54	-40 - 85°C	65	4.06	11.4x27.9	94.5%
IND065BLV	12 V±20%	16-34	-40 - 85°C	65	2.03	11.4x27.9	94%

Features and benefits

- Suitable for extreme environments (-40°C to 105°C extended temperature range, operating shock per Mil Std. 810 F to ± 40 G, and operating vibration per Mil Std. 810 F for selected SMT parts)
- High reliability (qualified with 1000 h high temperature operating bias [HTOB], 1000 h 85 RH / 85°C temperature humidity bias [THB], 700 cycle -40 to 125°C thermal cycling [TC] testing.)
- Suitable for conformal coating with dip or vapor deposition. Conformal coating can provide the protection to meet Salt Fog Test per IEC 60068-2-52 (Severity 3) and Mixed Gas Flow Test per Telcordia GR-3108 Outdoor Levels
- Outstanding transient response for powering demanding loads
- High efficiency (up to 97%)
- Easy-to-use complete modules enable fast design cycle and rapid TTM (Time To Market)
- Planned availability for a minimum of 10 years from product launch
- 3-year warranty, backed by ABB's proven quality processes

Applications

Automation equipment, factories and manufacturing, water treatment facilities, energy exploration and refineries, building and process controls systems and automation equipment, control cabinets and rooms, conveying equipment, vending machines, material handling and packaging equipment, chemical processing plants, HVAC (heating, ventilating and air conditioning) equipment, machinery



Resilient 3000

The RESILIENT 3000 power supply has extremely robust capability, yet is easy to use, economical, and has low up-front cost. Featuring a high-density, rugged enclosure, it has an oversized, highly-reliability fan, conformal coating and is designed to operate over a wide temperature range. It can function either as a stand-alone power supply or it can be connected in parallel with other power supplies and managed by RS485.

Feature-set flexibility makes this power supply an excellent choice for applications requiring operation over a wide output-voltage range or for charging batteries. Its solid design is intended for rugged applications where poor AC grid conditions and temperature extremes may be experienced. The electrical user interfaces are designed for extreme simplicity for quick installation and turn-up.



Model	Input	Cooling	Input range (V)	V OUT	I OUT	Efficiency
EP3000AC48INZ	AC Rear, C19	Fan, Front to Back Airflow	90-290 V	48-58 V	55.5 A @ 54 V	95%

Features and Benefits

- Low cost of ownership
- Oversized high-reliability fan
- Conformal coating for use in dirty environments
- Rugged design for temperature extremes
- Rugged design for dirty AC grid conditions
- Wide range output
- Can be paralleled for load sharing
- Simple installation, simple operation
- Ability to charge batteries
- RS485 communications capable
- High efficiency 95%+

High-voltage DC power family

Introducing a new family of high-voltage DC power ready for work in the most demanding data, computing and industrial applications. The family supports those applications where power density and efficiency is most critical. Standards-based 380 V power provides the energy needed while minimizing infrastructure costs by reducing power distribution costs and enabling energy to travel greater distances without incurring voltage drop. Designers will appreciate the density gains that using less copper will facilitate.

The CC12500 and CH12500 rectifier convert readily-available 3-phase Industrial power to 380 V DC for distribution to your system. These rectifiers are highly efficient and are optimized for being configured into dense power distribution solutions. For example, both power supplies are completely fanless and conduction cooled. The CH12500 is designed to be mated to a customer-supplied cold plate. A finned heat-sink kit is available for field installation, allowing customers to use their own system fan for cooling. On the other hand, customers who already have liquid cooling in their application will appreciate the CC12500, which has fully-integrated liquid cooling built in.

The downstream component of the family consists of high-voltage DC Power Entry Modules, which convert the 380 V DC power to 48 V for use with most of today's data and industrial equipment. We call this family the "CP-short" because it contains the familiar topology used in the CP product line, which has proven so reliable, but is packaged in a much denser 280 mm footprint. These fan-cooled modules are not only compact, they are versatile as well. First, they are ready for future migration to 380 V because they can be powered by Universal AC Line voltage or by 380 V DC input.

They are ready to switch over from AC to high-voltage DC whenever you are, thereby minimizing your HVDC upgrade costs. They add further versatility by having airflow direction agility. They support front-to-back or back-to-front airflow direction. The model names are CP3000HV54TEZ-FSG (back-to-front airflow) and CP3000HV54TEZ-FSGR (front-to-back airflow). Finally, the family is being rounded out by adding 380 V DC board-mounted bus converter





CC12500 and CH12500 rectifiers features and benefits

- 12.5 kW, 360-380 V DC output, 96% efficiency
- AC Input 3-wire, 3 ph - 400/480 VAC
- Hot plug, hot swap, with redundant safety interlock
- Conduction cooled with optional finned heatsink
- Water cooled with dripless quick disconnect
- High resistance mid-point ground (HRMG) ± 190 VDC output
- Internal HRMG fault detector circuit
- RS-485 communication Protocol
- Integrated heatplate, ready for mounting to cold wall

CP3000 “short” features and benefits

- 3.0 kW, 48-56 V DC output, 97% efficiency
- Dual rated AC or HVDC input
- AC input, 1ph, 80-264 VAC
- DC input, 180-400 VDC
- Input connector rated for both AC and HVDC
- Hot plug, hot swap
- Super compact design
- Front to back or back to front airflow

AC-DC and DC-DC power supplies

Product matrix

	Model	Nominal output (negative)	Input	Digital comm.	Profile	Nominal input	Max output	Power range									
								200 W	500 W	1 KW	1.5	2 KW	2.5	3 KW	3.5		
Open frame AC-DC power supplies	CLP0112FP	12 V	Top	Not available	Open frame	1 PH (110/220 vac)	150 W	■									
	CLP0205FP	5 V	Top	Not available	Open frame	1 PH (110/220 vac)	200 W	■									
	CLP0212FP	12 V	Top	Not available	Open frame	1 PH (110/220 vac)	200 W	■									
	CLP0224FP	24 V	Top	Not available	Open frame	1 PH (110/220 vac)	200 W	■									
	CLP0228FP	28 V	Top	Not available	Open frame	1 PH (110/220 vac)	200 W	■									
	CLP0412FP	12 V	Top	Not available	Open frame	1 PH (110/220 vac)	450 W	■	■								
	CLP0424FP	24 V	Top	Not available	Open frame	1 PH (110/220 vac)	450 W	■	■								
	CLP0428FP	28 V	Top	Not available	Open frame	1 PH (110/220 vac)	450 W	■	■								
	CLP0448FP	48 V	Top	Not available	Open frame	1 PH (110/220 vac)	450 W	■	■								
	FLP0412FP	12 V, 24 V	Top	Not available	Open frame	1 PH (110/220 vac)	450 W	■	■								
	CLP0512FP	12 V	Top	Not available	Open frame	1 PH (110/220 vac)	550 W	■	■								
AC-DC and DC-DC front ends (12 V OUT)	CAR0512FP	12 Vdc	Rear	I ² C/PMBus	1 U	1 PH (110/220 vac)	500 W	■	■								
	MPR0712TE	12 Vdc	Rear	I ² C/PMBus	1 U	1 PH (110/220 vac)	700 W	■	■								
	SLP0712TE	12 Vdc	Front	I ² C/PMBus	1 U	1 PH (110/220 vac)	750 W	■	■								
	CAR0812FP	12 Vdc	Front	I ² C/PMBus	1 U	1 PH (110/220 vac)	850 W	■	■								
	CAR0812DC	12 Vdc	Front	I ² C/PMBus	1 U	48 Vdc	850 W	■	■								
	CAR1212DC	12 Vdc	Rear	I ² C/PMBus	1 U	48 Vdc	1200 W	■	■	■							
	CAR1212FP	12 Vdc	Rear	I ² C/PMBus	1 U	1 PH (110/220 vac)	1250 W	■	■	■							
	CAR1612FP	12 Vdc	Front	I ² C/PMBus	1 U	1 PH (110/220 vac)	1600 W	■	■	■	■						
	CAR1812FP	12 Vdc	Front	I ² C/PMBus	1 U	1 PH (110/220 vac)	1800 W	■	■	■	■						
	CAR2012TE	12 Vdc	Front	I ² C/PMBus	1 U	1 PH (110/220 vac)	2000 W	■	■	■	■						
	CAR2512TE	12 Vdc	Front	I ² C/PMBus	1 U	1 PH (110/220 vac)	2500 W	■	■	■	■						
	CAR2512DC	12 Vdc	Front	I ² C/PMBus	1 U	1 PH (110/220 vac)	2500 W	■	■	■	■						
	CAR3012FP	12 Vdc	Front	I ² C/PMBus	1 U	1 PH (110/220 vac)	3000 W	■	■	■	■						

Product matrix

Model	Nominal output	Input	Digital comm.	Profile	Nominal input	Max output	Power range														
							200 W	500 W	1 KW	1.5 KW	2 KW	2.5 KW	3 KW	3.5 KW	4 KW	6 KW	12.5 KW				
EP0500UTE	42-52 V	Rear	RS485	1 U	1 PH (110/220 vac)	500 W	█														
EP0500V	24 V	Rear	RS485	1 U	1 PH (110/220 vac)	500 W	█														
EP1000TE	42-52 V	Rear	RS485	1 U	1 PH (110/220 vac)	1000 W	█														
EP1600TE	42-52 V	Rear	RS485	1 U	1 PH (110/220 vac)	1600 W	█														
CP2000DC	42-52 V	Rear	I ² C/PMBus/ RS485	1 U	48/50 Vdc	2000 W	█														
CP2000TE	42-58 V	Rear	I ² C/PMBus/ RS485	1 U	1 PH (110/220/ 277 vac)	2000 W	█														
	18-58 V	Rear	I ² C/PMBus/ RS485	1 U	1 PH (110/220/ 277 vac)	2000 W	█														
CP2500DC	42-52 V	Rear	I ² C/PMBus/ RS485	1 U	48/50 Vdc	2500 W	█														
CP2500DC-F	42-52 V	Front	I ² C/PMBus/ RS485	1 U	48/50 Vdc	2500 W	█														
CP2725TE	42-58 V	Rear	I ² C/PMBus/ RS485	1 U	1 PH(110/ 220/277 vac)	2725 W	█														
	18-58 V	Rear	I ² C/PMBus/ RS485	1 U	1 PH(110/ 220/277 vac)	2725 W	█														
EP3000TE	42-52 V	Rear	I ² C/PMBus/ RS485	1 U	1 PH (110/ 220 vac)	3000 W	█														
CP3000TE	42-52 V	Rear	I ² C/PMBus/ RS485	1 U	1 PH(110/ 220/277 vac)	3000 W	█														
CP3000TE-F	42-52 V	Front	I ² C/PMBus/ RS485	1 U	1 PH (110/220 vac)	3000 W	█														
CP3000TE-FSG(R)	48-56 V	Front	I ² C/PMB us	1 U	240/280 V DC or 1 PH 110/220 VAC	3000 W	█														
CP3500TE	42-58 V	Rear	I ² C/PMBus/ RS485	1 U	1 PH (110/ 220/277 vac)	3500 W	█														
	18-58 V	Rear	I ² C/PMBus/ RS485	1 U	1 PH (110/220 vac)	3500 W	█														
CP3500TE	23-65 V	Rear	I ² C/PMBus/ RS485	1 U	1 PH (110/220 vac)	3500 W	█														
CC3500TE	18-58 V	Rear	I ² C/PMBus/ RS485	1 U	1 PH (110/220 vac)	3500 W	█														
	42-54 V (52 V Default)	Rear	RS485	1 U	3 PH (380/ 480 vac)	6000 W	█														
GP100MTE	42-54 V (54 V Default)	Rear	I ² C/PMBus	1 U	3 PH (380/ 480 vac)	6000 W	█														
	18-58 V	Rear	I ² C/PMBus	1 U	3 PH (380/ 480 vac)	6000 W	█														
GP100MTE-FB	18-58 V	Rear	I ² C/PMBus	1 U	3 PH (400/ 480 vac)	6000 W	█														
CH12500H3C	365-400 V (380 V Default)	Rear	RS485	1 U	3 PH (400/ 480 vac)	12500 W	█														

AC-DC front ends & rectifiers
DC-DC converters

Open frame power supply

CLP open frame power supply

In a 2x4-inch footprint smaller than an iPhone®, the 12 Vdc single-output CLP0212 open frame power supply delivers 80 PLUS® Gold energy efficiency. Half the size of other power supplies in this segment, the CLP series is specifically designed to handle power challenges associated with tight space and low airflow. Offering a leading 18W/in³ power density in a 1U high, fanless form factor, the CLP series addresses a broad range of applications in new products from communications, computing and data storage original equipment manufacturers.



Model	Size(W x L x H)	Input voltage	Output voltage	Output current	Efficiency
CLP0112FP	2" x 4" x 1.4"	90-264 V	12 V	150 W	90%
CLP0205FP	2" x 4" x 1.4"	90-264 V	5 V	200 W	90%
CLP0212FP	2" x 4" x 1.4"	90-264 V	12 V	200 W	90%
CLP0224FP	2" x 4" x 1.4"	90-264 V	24 V	200 W	90%
CLP0228FP	2" x 4" x 1.4"	90-264 V	28 V	200 W	90%
CLP0412FP	3" x 5" x 1.4"	90-264 V	12 V	450 W	91%
CLP0424FP	3" x 5" x 1.38"	90-264 V	24 V	450 W	91%
CLP0428FP	3" x 5" x 1.38"	90-264 V	48 V	450 W	90%
CLP0448FP	3" x 5" x 1.38"	90-264 V	48 V	450 W	92%
FLP0412FP	3" x 7" x 1.45"	90-264 V	12 V/24 V/5 V/3.3 V	450 W	90%
CLP0512FP	3" x 6" x 1.38"	90-264 V	12 V	550 W	90%

Metal covers for the Open Frame CLP products are available. Please contact your ABB Sales Team for more details.

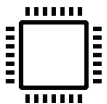

Breakthrough compact design
ABB's breakthrough design is 2x4. Less space but more power.



Wide operating temp for harsh conditions
Extended operating temperature range of 70°C to 85°C.



Reliable fanless cooling feature
Conduction and convection cooling. No moving parts to fail.



High efficiency
Higher efficiency leads to lower operating expenses.



High-power density solution
It can power a small router or a large outdoor billboard.



Integrates easily into your product design
Compatible, compact, flexible and safe.

Front-end power supplies



CAR0812FP

- 850 watts / 12 V out
- Efficiency of 92%
- Power density of 18 W/in³
- Universal AC input range with active PFC
- 8.73 x 3.38 x 1.65" / 221.7 x 85.9 x 41.9 mm
- I²C / PMBus™ digital interface

CAR1612FP

- 1,600 watts / 12 V out
- Efficiency of 94.5%
- Power density of 20 W/in³
- Universal AC input range with active PFC
- 12.45 x 4.00 x 1.65" / 316.23 x 101.6 x 41.9 mm
- I²C / PMBus™ digital interface
- Mates with ACE164 shelf

CAR0812DC

- 850 watts / 12 V out
- Efficiency of 92%
- Power density of 18 W/in³
- 36-75 Vdc input range
- 8.73 x 3.38 x 1.65" / 221.7 x 85.9 x 41.9 mm
- I²C/PMBus™ digital interface

CAR1812FP

- 1,800 watts / 12 V out
- Efficiency of 94%
- Power density of 22 W/in³
- Universal AC input range with active PFC
- 12.45 x 4.00 x 1.65" / 316.23 x 101.6 x 41.9 mm
- I²C / PMBus™ digital interface
- Mates with ACE184RUW shelf

CAR1212FP

- 1,200 watts / 12 V out
- High efficiency operation-up to 89%
- Power density of 16 W/in³
- Universal AC input range with active PFC
- 11.20 x 4.00 x 1.65" / 284.5 x 101.6 x 41.9 mm
- I²C / PMBus™ digital interface

CAR2012TE

- 2,000 watts / 12 V out
- Efficiency of 94.5%
- Power density of 22 W/in³
- Universal AC input range with active PFC
- 12.89 x 4.00 x 1.61" / 327.46 x 101.6 x 40.89 mm
- I²C / PMBus™ digital interface
- Mates with ACE184RUW shelf

CAR1212DC

- 1,200 watts / 12 V out
- High efficiency operation-up to 90%
- Power density of 16 W/in³
- 36-75 Vdc input range
- 11.20 x 4.00 x 1.65" / 284.5 x 101.6 x 41.9 mm
- I²C / PMBus™ digital interface

CAR2012DC

- 2,500 watts / 12 V out
- High efficiency operation-up to 92%
- Power density of 25 W/in³
- 36-75 Vdc input range
- 15.38 x 4.00 x 1.65" / 390.5 x 101.6 x 41.9 mm
- I²C / PMBus™ digital interface



CAR2512TE

- 2,500 watts / 12 V out
- Efficiency up to 94%
- Power density of 25 W/in³
- Universal AC input range with active PFC
- 15.38 x 4.00 x 1.65" / 378.0 x 102.0 x 41.9 mm
- I²C / PMBus™ digital interface

CAR0424FP

- 400 watts / 24 V out
- Efficiency up to 91% peak
- Top side fan
- Acoustic noise 45 dbA
- 8.1 x 3.94 x 1.58" / 205.7 x 100.0 x 40.1 mm
- Class B EMI (conducted & radiated)

CAR1248FP

- 1,200 watts / 48 V out
- High-efficiency operation-up to 91%
- Power density of 19 W/in³
- Universal AC input range with active PFC
- 11.20 x 3.44 x 1.65" / 284.5 x 87.4 x 41.9 mm
- I²C / PMBus™ digital interface
- Mates with ACE125 shelf

CAR2548FP

- 2,500 watts / 48 V out
- High-efficiency operation-up to 91%
- Power density of 27 W/in³
- Universal AC input range with active PFC
- 14.25 x 4.00 x 1.65" / 362.0 x 102.0 x 40.9 mm
- I²C / PMBus™ digital interface

- Mates with ACE254 shelf

CAR3012TE

- 3,000 watts / 12 V out
- Efficiency - up to 96%
- Power density of 30 W/in³
- 15.38 x 4.00 x 1.65" / 378.0 x 102.0 x 41.9 mm
- I²C / PMBus™ digital interface

CAR2024FP

- 2,000 watts / 24V out
- High efficiency operation-up to 90.5%
- Power density of 21 W/in³
- Universal AC input range with active PFC
- 14.25 x 4.00 x 1.65" / 316.2 x 101.6 x 41.9 mm
- I²C / PMBus™ digital interface
- Mates with ACE204 shelf

CAR2548TN

- 2,500 watts / -48 V out
- High efficiency operation-up to 91%
- Power density of 27 W/in³
- Universal AC input range with active PFC
- 14.25 x 4.00 x 1.61" / 362.0 x 102.0 x 40.9 mm
- I²C / PMBus™ digital interface
- Mates with ACE254 shelf

CAR2548DC

- 2,500 watts / 48 V out
- High-efficiency operation-up to 91%
- Power density of 27 W/in³
- 36-75 Vdc input range
- 14.25 x 4.00 x 1.61" / 362.0 x 102.0 x 40.9 mm
- I²C / PMBus™ digital interface
- Mates with ACE254 shelf



Fanless conduction cooled front ends

The industry's first half U height fanless AC-DC rectifier offers an alternative means for thermal management that lends itself to conduction, convection, forced air or even liquid cooling applications. This shift toward alternative cooling capability allows system engineers to innovate and explore new thermal-mechanical options, opening up considerable new opportunities. Eliminating fans reduce unwanted audible noise while simultaneously increasing system MTBF (mean time between failure) and extending system reliability. In a sleek form factor, the CCR0512 reduces the real estate needed for use in hard-to-reach applications and low clearance areas.

With a universal AC input, this 12 Vdc, 500 W output fanless solution supports N+N redundant capability and current sharing, allowing end system scalability or fault tolerant operation. The CCR0512 is the perfect low-to-mid power platform geared for 12 V applications with low profile constraints such as networking, test equipment and thin client server applications.

CCR0512

- Conduction cooling for fanless operation
- Compact 0.5 U Profile
- Overall Dimensions: 0.877" x 3.35" x 8.790" / 223.2 x 85.1 x 22.3 mm
- 12 Vdc, 500 W output
- 10.8 to 13.2 Vdc output voltage programmability
- Universal AC input with Active PFC
- Hot plugability

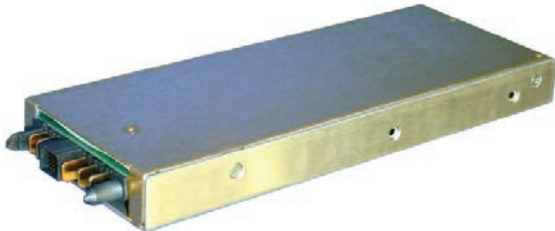

- Redundant parallel operation
- Active load sharing (single wire)
- Analog, I²C or PMBus™ means of control and monitoring
- Remote on/off
- Remote Sense (up to 0.25 V of total compensation)
- No Minimum Load Requirements
- Three visual LED Indicators; Input, Output and Fault status
- 3.3 or 5.0 Vdc 2 A Standby Output
- UL certified to UL60950-1, CAN/CSA† C22.2
- No.60950-1 and EN60950-1(VDE‡ 0805-1) Licensed
- CE mark meets 2006/95/EC directives
- ISO 9001 and ISO 14001 certified manufacturing facility
- Compliant to RoHS EU Directive 2002/95/EC
- CCR0512FPS: Stand Alone version with AC/DC Terminals

CC1600

- Potted, fanless and conduction cooled
- 11.52" L x 5.29" W x 1.83" H
- 1600 W @ 200 V-240 Vac and baseplate temp < 50°C
- Remote on/off control of the main output using R5485
- Supports redundant and parallel operation



Rectifiers and converters

EP1000TE / EP1600TE

- 1,000 or 1,600 watts / 54 V out
- High-efficiency operation-up to 95%
- Power density up to 27 W/in³
- Universal AC input range with active PFC
- 8.19 x 4.58 x 1.58" / 208.0 x 116.5 x 40.2 mm
- RS485 communication interface
- Mates with SPS shelf family
- RoHS6

CP3000TE / CP3500TE / CC3500

- 3,000, 3,500 / 54 V out
- Higher power, same footprint
- High efficiency operation-approaching 97%
- Power density of up to 40 W/in³
- 13.85 x 4.00 x 1.63" / 356.0 x 101.6 x 41.4 mm
- I²C and RS485 communication interface
- "CP" mates with Higher Power CPL shelf family

CP2000DC / CP2500DC

- 2,000 or 2,500 watts / 54 V out
- 40-60 Vdc input range
- High efficiency operation-up to 92%
- Power density up to 27.6 W/in³
- 13.85 x 4.00 x 1.63" / 352.0 x 101.6 x 41.4 mm
- I²C and RS485 digital interface
- Mates with CPL PEM shelf

CP3000TE-F / CP2500PE-F

- Front connector AC rectifier / DC converter pair
- Rectifier 3,000 W, front AC input, 54 V out
- Converter 2,500 W, front DC input, 54 V out
- Slot swappable
- 17.207 x 4.00 x 1.63" / 437.06 x 101.6 x 41.4 mm
- I²C communication interface

CP2000TE / CP2500TE / CP2725TE

- 2,000, 2,500 or 2,725 watts / 54 V out
- High-efficiency operation-approaching 97%
- Power density of up to 30 W/in³
- 13.85 x 4.00 x 1.63" / 356.0 x 101.6 x 41.4 mm
- I²C and RS485 communication interface
- Mates with CPL shelf family

GP100R / GP100M / GP100R-IN

- Compact Three Phase Delta Rectifier
- 6,000 W, 54 V out, RS485 Comm (GP100R)
- 6,000 W, 54 V out, PMBus™/I²C Comm (GP100M)
- 6,000 W, 48 V out, RS485 Comm (GP100R-IN)
- 1 RU form factor, 12 kW/RU in 19 in
- 17.53 x 7.975 x 1.61" / 445.26 x 202.5 x 40.89 mm
- High-efficiency operation-approaching 97%
- I²C and RS485 communication interface
- Mates GP shelf family



Energy systems

SPS platform

- 48 V Embedded or available rectifier shelf
- Mates with EP1000/1600 rectifier modules
- 1U High 19" / 483.0 mm rack mount
- Maximum 10.37" / 264.0 mm depth
- Adjustable mounting ears (flush or mid-mount)
- Rear / front panel DC distribution options
- Breaker and fuse panel options
- Optional Pulsar Edge Controller
- Advanced rectifier (and battery) management



CPL platform

- 48 V rectifier shelf
- I²C or RS485 control options
- Mates with CP2000TE / CP2500TE / CP2725TE rectifier modules
- 1U High 19" / 483.0 mm rack mount
- Maximum 17.21" / 487.0 mm depth
- Adjustable mounting ears (flush or mid-mount)
- Rear / front panel DC distribution options
- Breaker and fuse panel options
- Optional Pulsar Edge Controller
- Advanced Rectifier (and battery) management



The CP2000TE and CP2725TE are both 80 PLUS Platinum certified in a compact 1U footprint with up to 40 W/in³. The CPL is a highly-flexible solution, which has two communications protocols on board for every power supply, increasing its flexibility for use in embedded OEM applications or in external rackmounted applications. The I²C

protocol used in OEM embedded applications helps fully integrate the power supply into a platform and the RS485 communications using Galaxy Protocol allows standalone systems full alarm and communication capability, as well as battery management. The CPL provides AC to 48 V power conversion downstream of an AC UPS system or as the primary power conversion step in DC UPS systems with direct connected battery backup. Versions are also available

with PoE isolation.

GP platform

- 48 V rectifier shelf
- I²C or RS485 control options
- Mates with GP100 48 V rectifier modules
- 3 ph Delta AC Power (neutral not required)
- 1U High 19" / 483.0 mm rack mount



Power shelves



ACE125

- 48 V front end or rectifier shelf
- Mates with CAR1248 modules
- 5 bay power shelf
- 5 x 1,200 W power modules
- 4,800 W N+1 redundant
- 6,000 W total power
- 1U High 19" / 483.0 mm rack mount
- 14.98" / 380.5 mm depth
- Class B emissions with fully-populated shelf

ACE254

- 48 V front end or rectifier shelf
- Mates with CAR2548
- 4 bay power shelf
- 4 x 2,500 W power modules
- 7,500W N+1 redundant
- 10,000 W total power
- 1U High 19" / 483.0 mm rack mount
- 18.07" / 459.0 mm depth
- Class B emissions with fully-populated shelf

ACE164

- 12 V front end or rectifier shelf
- Mates with CAR1612 modules
- 4 bay power shelf
- 4 x 1,600 W power modules
- 4,800 W N+1 redundant
- 6,400 W total power
- 1U High 19" / 483.0 mm rack mount
- 16.4" / 416.6 mm depth
- Class A emissions with fully-populated shelf

ACE204

- 24 V front end or rectifier shelf
- Mates with CAR2024FP modules
- 4 bay power shelf
- 4 x 2000 W power modules
- 6000W N+1 redundant
- 8,000W total power
- 1U High 19" / 483.0 mm rack mount
- 18.07" / 459.0 mm depth
- Class B emissions with fully-populated shelf

ACE184

- 12 V front end or rectifier shelf
- Mates with CAR1812 modules
- 4 bay power shelf
- 4 x 1,800 W power modules
- 5,400 W N+1 redundant
- 7,200 W total power
- 1U High 19" / 483.0 mm rack mount
- 16.4" / 416.6 mm depth
- Class A emissions with fully-populated shelf

High power Barracuda*

The high power Barracuda* series of DC-DC converters is a new generation of DC-DC power modules designed to support 10.4 -12 Vdc intermediate bus applications where multiple low voltages are subsequently generated using point of load (POL) converters, as well as other applications requiring a tightly-regulated output voltage. The converter incorporates digital control, synchronous rectification technology, and innovative packaging techniques to achieve higher efficiencies, leading to lower power dissipation. Standard features include on/off control, output overcurrent and overvoltage protection, overtemperature protection, input under and overvoltage lockout. The output is fully isolated from the input, allowing versatile polarity configurations and grounding connections. Built-in filtering for both input and output minimizes the need for external filtering.

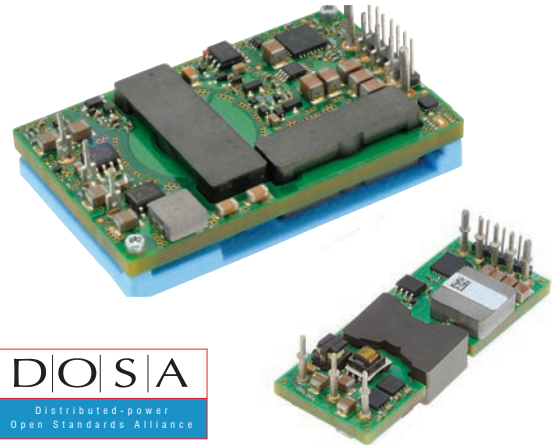

Barracuda* series

- High-efficiency operation up to 96%
- Remote sense and output voltage trim
- DOSA-standard quarter and eighth brick
- Negative remote on/off logic
- Output over-current/overvoltage protection
- Over-temperature protection
- Wide operating temperature range (-40°C to 85°C)
- 1/8 Brick-2.30 x 0.90 x 0.44" / 58.4 x 22.8 x 11.3 mm
- 1/4 Brick-2.30 x 1.45 x 0.46" / 58.4 x 36.8 x 11.7 mm
- Optional baseplate

1/8 Brick

Model	Input voltage	Output voltage	Output current	Efficiency
EBVW012A7B	48V (36-75 V)	12 V	12.7 A	95%
EBVW020A0B	48V (36-75 V)	12 V	20 A	95%
EBVW025A0B	48V (36-75 V)	12 V	25 A	95%

1/4 Brick

Model	Input voltage	Output voltage	Output current	Efficiency
QBVW025A0B	48 V (36-75 V)	12 V	25 A	96%
QBVW033A0B	48 V (36-75 V)	12 V	33 A	96%
QSVW035A0B	48 V (36-75 V)	12 V	35 A	96%
QSVW042A0B	48 V (36-75 V)	12 V	42 A	95%
QSVW050A0B	48 V (36-75 V)	12 V	50 A	96%
QBVE067A0B	48 V (40-60 V)	12 V	67 A	96%
QBVE094A0S	50/54 (45-56 V)	10.4 V	94 A	97%

Barracuda* digital series

- Conforms to new DOSA standard for second generation single output pin DC-DC converters with digital connections
- Fully backwards compatible with other Barracuda* series
- Digital interface with PMBus™
- Two user-configurable pins for remote sense or output trim

1/8 Brick

Model	Input voltage	Output voltage	Output current	Efficiency
EBDW020A0B	48 V (36-75 V)	12 V	20 A	95%
EBDW025A0B	48 V (36-75 V)	12 V	25 A	95%

1/4 Brick

Model	Input voltage	Output voltage	Output current	Efficiency
QBDW025A0B	48 V (36-75 V)	12 V	25 A	96%
QBDW033A0B	48 V (36-75 V)	12 V	33 A	96%
QSDW035A0B	48 V (36-75 V)	12 V	35 A	96%
QSDW050A0B	48 V (36-75 V)	12 V	50 A	96%
QBDE055A0B	48 V (40-60 V)	12 V	55 A	96%
QBDE067A0B	48 V (40-60 V)	12 V	67 A	96%



Polaris* Direct Drive

The Polaris Direct Drive (Polaris DD) power module converts 48 V direct to power XPU (CPU or GPU), DDR and ASIC. It delivers up to 230 A output current. This module operates over a wide range of input voltages ($40 \text{ Vdc} \leq V_{in} \leq 59.5 \text{ Vdc}$) and provides a precisely-regulated output voltage from 0.6 Vdc to 2 Vdc, which is programmable via PMBus™. Features include remote on/off, adjustable output voltage, over-current and over-temperature protection. The Polaris DD module's digital implementation of the Tunable Loop™ feature allows the user to optimize the output voltage dynamic response at the load thus reducing external output capacitance requirements and system PWB area leading to additional cost savings.



HVDS230A0Y Polaris DD series

Features

- High peak efficiency > 94% at $V_{in}=48 \text{ Vdc}$
- Output voltage programmable from 0.6 Vdc to 2 Vdc via PMBus™
- Fully-regulated output voltage at V_{in} minimum
- Low output ripple and noise
- Digital Tunable Loop™ to optimize dynamic output voltage response via PMBus™
- Output over-current/voltage protection
- Over-temperature protection
- Wide operating temperature range -40°C to 85°C , continuous
- 500 Vdc input-to-output isolation
- Quarter brick (approximate dimensions):
 - 58.4 mm x 36.83 mm x 18.5 mm
 - (2.3 in x 1.45 in x 0.728 in)

Model	Input voltage	Output voltage	Output current	Efficiency
-------	---------------	----------------	----------------	------------



Hammerhead*

The Hammerhead* series power modules are isolated DC-DC converters that operate over an ultra-wide input voltage range of 18-75 Vdc and provide a single precisely-regulated output voltage. This series is a low cost, smaller size replacement for our legacy products, LW/LAW/LC/SC/SW with enhanced performance parameters. The output is fully isolated from the input, allowing versatile polarity configurations and grounding connections. The modules exhibit high efficiency and built-in filtering for both input and output, which minimizes the need for external filtering. The module is fully self-protected with output overcurrent and overvoltage, overtemperature and input under voltage shutdown control.

- Ultra-wide input voltage range, 18 to 75 Vdc
- No minimum load
- High efficiency

- Constant switching frequency
- Low output ripple and noise
- Small size and low profile, follows industry standard footprints
- Surface mount (SMT) or through hole (TH)
- Reflow process compliant, both SMT and TH versions
- Positive remote on/off logic
- Output over-current/voltage protection (hiccup)
- Over-temperature protection
- Output voltage adjust: 90% to 110% of V_o , nom
- Wide operating temperature range (-40°C to 85°C)
- Meets the voltage and current requirements for ETSI 300-132-2 and complies with and licensed for basic insulation rating per EN60950-1
- 2250 Vdc isolation tested in compliance with IEEE 802.3 PoE standards
- ISO 9001 and ISO 14001 certified manufacturing facilities

SHHD Hammerhead* series

15 W / 5 A max power

- 1.10 x 0.96 x 0.34" / 27.94 x 24.38 x 8.5 mm
- Surface mount or through-hole



Model	Input voltage	Output voltage	Output current	Efficiency
SHHD001A3B	18-75 V	12 V	1.3 A	88%
SHHD003A0A	18-75 V	5 V	3 A	87%
SHHD005A0F	18-75 V	3.3 V	5 A	88%

2250 Vdc isolation for PoE applications

KHHD Hammerhead* series

50 W / 15 A max power

- 1.30 x 0.90 x 0.37" / 33.0 x 22.9 x 9.3 mm
- Surface mount or through-hole



Model	Input voltage	Output voltage	Output current	Efficiency
KHHD002A5B	18-75 V	12 V	2.5 A	90%
KHHD006A0A	18-75 V	5 V	6 A	91%
KHHD010A0F	18-75 V	3.3 V	10 A	91%
KHHD004A2B	18-75 V	12 V	4.2 A	90%
KHHD010A0A	18-75 V	5 V	10 A	91%
KHHD015A0F	18-75 V	3.3 V	15 A	91%

2250 Vdc isolation for PoE applications



EHHD Hammerhead* series

75 W / 20 A max power

- 2.28 x 0.90 x 0.30" / 57.9 x 22.8 x 7.6 mm
- Through-hole

Model	Input voltage	Output voltage	Output current	Efficiency
EHHD006A0B	18-75 V	12 V	6 A	93%
EHHD015A0A	18-75 V	5 V	15 A	91%
EHHD020A0F	18-75 V	3.3 V	20 A	91%
EHHD024A0A	18-75 V	5 V	24 A	91%
EHHD036A0F	18-75 V	3.3 V	36 A	90%

2250 Vdc isolation for PoE applications



QHHD Hammerhead* series

228 W / 19 A max power

- 2.30 x 1.45 x 0.46" / 58.4 x 36.8 x 11.7 mm
- Through-hole

Model	Input voltage	Output voltage	Output current	Efficiency
QHHD019A0B	18 - 75 V	12 V	19 A	93%

2250 Vdc isolation for PoE applications



SHHN Dual Output Hammerhead* series

9 W / 0.3 A max power

- 1.10 x 0.96 x 0.34" / 27.9 x 24.4 x 8.5 mm
- Surface mount and through-hole

Model	Input voltage	Output voltage	Output current	Efficiency
-------	---------------	----------------	----------------	------------

Low power Barracuda*

Offering optimum efficiency, the low power modules are targeted at a broad range of communications equipment. These modules can be used in powering distributed power and intermediate bus architectures, as well as the latest integrated circuits or microprocessors. These isolated DC-DC converters can deliver up to 120 W of output power and provide a precisely regulated output voltage over a wide range of input voltages ($V_{in} = 36-75$ Vdc). Convenient packaging options, combined with open-frame construction, enable designers to develop cost- and space-efficient solutions. Additional features include remote on/off, remote sense, output voltage adjustment, overcurrent/voltage protections and overtemperature protection.

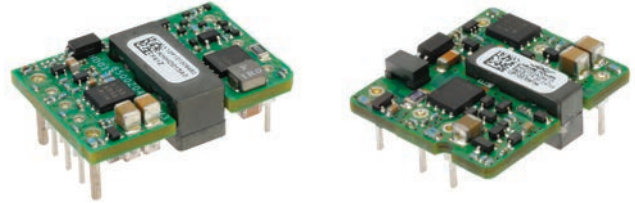

Applications

- Distributed power architectures
- Wireless networks
- Access and optical network equipment
- Microprocessor powered applications
- Enterprise networks
- Latest generation IC's (DSP, FPGA, ASIC)

SSTW Barracuda* low power series

15 W / 5 A max power

- 1.10 x 0.96 x 0.34" / 27.94 x 24.38 x 8.5 mm
- Surface mount or through-hole

Model	Input voltage	Output voltage	Output current	Efficiency
SSTW001A3B	48V (36 - 75 V)	12 V	1.3 A	88%
SSTW003A0A	48V (36 - 75 V)	5 V	3 A	87%
SSTW005A0F	48V (36 - 75 V)	3.3 V	5 A	88%

2250 Vdc isolation for PoE applications

KSTW Barracuda* low power series

50 W / 15 A max power

- 1.30 x 0.90 x 0.37" / 33.0 x 22.9 x 9.3 mm
- Surface mount or through-hole

Model	Input voltage	Output voltage	Output current	Efficiency
KSTW002A5B	48 V (36-75 V)	12 V	2.5 A	90%
KSTW006A0A	48 V (36-75 V)	5 V	6 A	90%
KSTW010A0F	48 V (36-75 V)	3.3 V	10 A	90%
KSTW004A2B	48 V (36-75 V)	12 V	4.2 A	90%
KSTW010A0A	48 V (36-75 V)	5 V	10 A	91%
KSTW015A0F	48 V (36-75 V)	3.3 V	15 A	91%

2250 Vdc isolation for PoE applications

KNW Barracuda* low power series

66 W / 20 A max power

- 1.30 x 0.90 x 0.40" / 33.0 x 22.9 x 10.2 mm
- Surface mount or through-hole

Model	Input voltage	Output voltage	Output current	Efficiency
KNW013A0A	48 V (36-75 V)	5 V	13 A	91%
KNW020A0F	48 V (36-75 V)	3.3 V	20 A	91%

2250 Vdc isolation for PoE applications

ESTW Barracuda* low power series

120 W / 36 A max power

- 2.3 x .90 x 0.34" / 58.4 x 22.8 x 11.3 mm
- Through-hole

Model	Input voltage	Output voltage	Output current	Efficiency
ESTW004A2C	48 V (36-75 V)	15 V	4.2 A	90%
ESTW010A0A	48 V (36-75 V)	5 V	10 A	91%
ESTW015A0F	48 V (36-75 V)	3.3 V	15 A	91%
ESTW006A0B	48 V (36-75 V)	12 V	6 A	90%
ESTW015A0A	48 V (36-75 V)	5 V	15 A	91%
ESTW025A0F	48 V (36-75 V)	3.3 V	25 A	92%
ESTW010A0B	48 V (36-75 V)	12 V	10 A	93%
ESTW020A0S6R0	48 V (36-75 V)	6 V	20 A	92.5%
ESTW024A0A	48 V (36-75 V)	5 V	24 A	92%
ESTW036A0F	48 V (36-75 V)	3.3 V	36 A	92%

2250 Vdc isolation for PoE applications

KBVW Barracuda* low power series

70 W / 6 A max power

- 1.30 x 0.90 x 0.37" / 33.0 x 22.9 x 9.3 mm
- Surface mount or through-hole

Model	Input voltage	Output voltage	Output current	Efficiency
KBVW006A0B	48 V (36-75 V)	12 V	6 A	91%

Power amplifiers

A new generation of power modules designed for maximum cost effectiveness and power density, the industry standard half-brick series DC-DC converter is an ideal choice for high voltage and power amplifier applications.

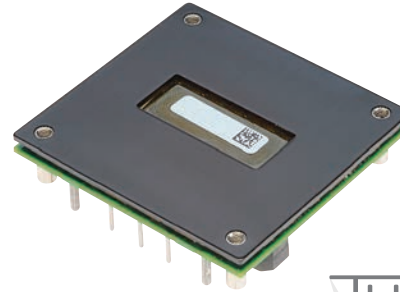

TUNABLE LOOP
A LINFAGE POWER TRADEMARK

Orca* Series Half Brick modules

450 watts maximum power

- 36-75 Vdc input/28-48 Vdc output model
- Output voltage adjustment trim, 16.0 to 35.2 Vdc or 28.8-57.6 Vdc
- High efficiency operation up to 94%
- Integral metal baseplate with optional threaded inserts
- Optional Tunable Loop* for optimized output capacity
- Operates at full power to case temperatures of 100°C
- 2.27 x 2.39 x 0.5" / 57.7 x 60.7 x 12.7 mm

Model	Input voltage	Output voltage	Output current	Efficiency
JRCW016A0R	48 V (36-75 V)	28 V	16 A	94%
JNCW016A0R	48 V (36-75 V)	28 V	16 A	94%
JRCW450R	48 V (36-75 V)	32 V	14 A	94%
JRCK017A0R	48 V (36-60 V)	32 V	17 A	95%
JRCW450U	48 V (36-75 V)	48 V	9.4 A	94%

Orca* Series Eighth Brick modules

100 watts maximum power

- 36-75 Vdc input/28 Vdc output model
- Output voltage adjustment trim, 15.0 to 35.2 Vdc
- Very high efficiency operation up to 93.4% at full load
- Optional integral metal baseplate with optional threaded inserts
- Operates at full power to case temperatures of 85°C
- 2.3 x 0.9 x 0.35" / 58.4 x 23.0 x 8.8 mm



Model	Input voltage	Output voltage	Output current	Efficiency
ERCW003A6R	48 V (36-75 V)	28 V	3.6 A	93%



Filter & PIM modules

Filter modules

The internal operation of DC-DC converters utilizes pulsed voltages and currents, which can generate broad-spectrum noise that results in electro-magnetic emissions. To ease the task of meeting international standards that limit emissions, ABB offers a range of input filter modules with current ratings of 5 A, 7 A, 10 A, 12 A, and 20 A. One properly-sized filter module can be used with one or multiple DC-DC converter modules. Our filter modules reduce the levels of conducted common-mode and differential-mode noise, providing high-insertion loss throughout the frequency range regulated by such bodies as the International Special Committee on Radio Interference (CISPR) and the U.S. Federal Communications Commission (FCC). All of our filter modules are rated for differential input voltages up to 75 Vdc and common-mode input voltages up to 1500 Vdc. For further details on managing EMC, refer to individual DC-DC module and filter datasheets.



FLT007A0Z



FLT012A0Z



FLTR75V05Z



FLTR100V10Z



FLTR100V20Z

Model	Rated voltage	Rated current	Common-mode insertion loss	Differential-mode insertion loss	Resistance per leg (MOHMS)
FLT007A0Z	0-75 V	7 A max	60 dB	66 dB	25
FLT012A0Z	0-75 V	12 A max	56 dB	57 dB	20
FLTR75V05Z	0-75 V	5 A max	28 dB	25 dB	20
FLTR100V10Z	0-75 V	10 A max	36 dB	44 dB	14
FLTR100V20Z	0-75 V	20 A max	32 dB	36 dB	6.6

ATCA Power Input Modules (PIM)

The PIM400 series of Power Input Modules is designed to greatly simplify the task of implementing dual redundant, hot swappable -48 Vdc power distribution with EMI filtering on an ATCA or other telecom boards. The PIM400 with optional digital interface (I²C capability, when used with a variety of ABB's series of Bus converters (e.g. Barracuda* Series) and POLs (e.g. DLynx* Series), provides for a simple, elegant power architecture solution for a wide variety of intelligent power architectures.



Model	Input voltage	Current rating	Auxiliary output 1	Auxiliary output 2	Options
PIM400Z	-36 to -75 V	10 A	3.3 V / 3.6 A	5.0 V / 0.15 A	-
PIM400KZ	-36 to -75 V	10 A	3.3 V / 3.6 A	5.0 V / 0.15 A	I ² C Digital Interface

Features

- Digital interface options with I²C
- Delivers up to 400 W of rated power
- -48 V / 10 A dual redundant input power distribution
- High efficiency: 98% typical
- Integral EMI filter designed for minimal external filtering
- OR'ing FETs for A&B feeds
- A&B feed loss or open fuse alarm
- Hot swap capability
- Inrush current protection
- Industry standard quarter brick size

Specifications

- Input voltage range -36 to -75 V
- Management power 3.3 V / 3.6 A & 5.0 V / 150 mA
- Operating temperature range: -40°C to 85°C
- Independent holdup capacitor charging voltage trimmable from 50 to 95 V

Protection features

- Reverse polarity protection
- Input undervoltage lockout
- Input transient overvoltage protection
- Overcurrent and temperature protection



Surface mount modules product matrix

	Model	Input voltage	Output voltage	Output current	Comm.	Dimensions	2 A	4 A	5 A	7 A	10 A	14 A	15 A	20 A	30 A	35 A	40 A	50 A	60 A	80 A	120 A	170 A
BoostLynx*	ABXS001	8.0-16.0 V	32.0-54.0 V	1 A	Analog	27.9 x 11.4 x 9.0 mm	■															
	ABXS002	8.0-16.0 V	16.0-34.0 V	2 A	Analog	27.9 x 11.4 x 7.5 mm	■															
	ABXS003	8.0-16.0 V	32.0-54.0 V	3 A	Analog	27.9 x 24 x 8.5 mm	■															
	ABXS005	8.0-16.0 V	16.0-34.0 V	5 A	Analog	27.9 x 24 x 8.5 mm	■	■														
ProLynx*	APXW003	9.0-36.0 V	3.0-18.0 V	3 A	Analog	20.32 x 11.43 x 8.5 mm	■	■														
	APXW005	9.0-36.0 V	3.0-18.0 V	5 A	Analog	20.32 x 11.43 x 8.5 mm	■	■														
	APXW012	9.0-36.0 V	3.0-18.0 V	12 A			■	■														
PicoTlynx*	APXS002	3.0-14.0 V	0.60-5.50 V	2 A	Analog	12.2 X 12.2 X 6.25 mm	■															
MicroTlynx*	APXK004	8.0-16.0 V	0.59-8.0 V	4 A	Analog	20.32 x 11.43 x 8.5 mm	■	■														
MegaTlynx*	APTS030	6.0-14.0 V	0.80-3.63 V	30 A	Analog	33 x 13.46 x 10.0 mm	■	■	■													
GigaTlynx*	APTS050	4.5-14.0 V	0.7-2.0 V	50 A	Analog	33 x 22.9 x 10.0 mm	■	■	■	■												

Single in-line package (SIP) product matrix

	Model	Input voltage	Output voltage	Output current	Comm.	Dimensions	2 A	5 A	10 A	15 A	20 A	30 A	40 A	50 A	60 A	80 A	120 A	170 A
Naos Raptor*	NQR002	3.0-14.0 V	0.6-5.5 V	2 A	Analog	10.4 x 16.5 x 8.1 mm	■											
	NSR003	4.5-14.0 V	0.59-6.0 V	3 A	Analog	10.4 x 16.5 x 7.84 mm	■	■										
	NSR006	4.5-14.0 V	0.59-6.0 V	6 A	Analog	10.4 x 16.5 x 7.84 mm	■	■	■									
	NQR010	4.5-14.0 V	0.59-6.0 V	10 A	Analog	10.4 x 16.5 x 8.4 mm	■	■	■	■								
	NSR020	4.5-13.8 V	0.59-6.0 V	20 A	Analog	36.8 x 15.5 x 9.2 mm	■	■	■	■	■							
	NSR040	5.0-13.8 V	0.60-5.0 V	40 A	Analog	36.8 x 27.9 x 10.7 mm	■	■	■	■	■	■						
	NSR050	5.0-14.0 V	0.60-2.0 V	50 A	Analog	36.8 x 27.9 x 20.1 mm	■	■	■	■	■	■	■					
	NSR060	5.0-13.8 V	0.60-5.0 V	60 A	Analog	65.5 x 31.8 x 11.6 mm	■	■	■	■	■	■	■	■				

Next-generation non-isolated / POL



Tunable Loop* technology

Improved footprints, transient response, and cost.
 When ABB first patented Tunable Loop*, it was a simple analog implementation of a resistor and capacitor in series across the point-of-load (POL) Trim and Output pins to optimize POL modules for multiple applications of varying demands. With the first implementation of Digital Tunable Loop*, ABB now extends the effectiveness fully into the digital world of DLynx II* and eliminates yet another component.

Without Tunable Loop*:
 High deviation and reduced control bandwidth with increased output capacitance.

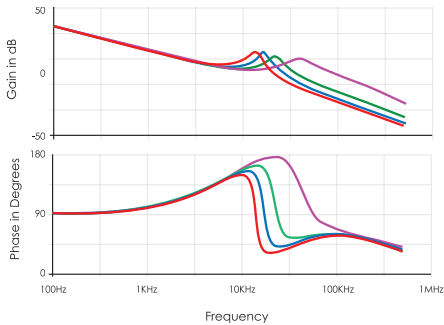

The figure below illustrates the transient response of a 12 A PicoDLynx* module at a 50% load step with varying external capacitance. In the example below, the maximum voltage deviation improves from 347 mV (1x47uF) to 222 mV (4x47uF) but the control loop bandwidth drops from 51 kHz to 24 kHz, increasing the duration of the voltage excursion. This activity is consistent with the reduction in control bandwidth and poorer phase margin caused by increased capacity.

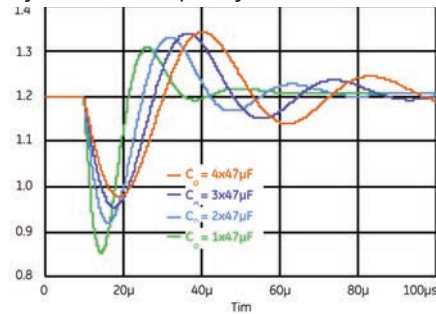

The goal of Tunable Loop* is to regain the bandwidth lost with increased capacitance. If we fix the value of RTune to 330 ohms and vary CTune from 1 pF to 2700 pF, we regain

control bandwidth back to 82 KHz and achieve a 4.8x reduction in voltage deviation.

With Tunable Loop*:
 Substantially reduced deviation through improved control bandwidth and reduced

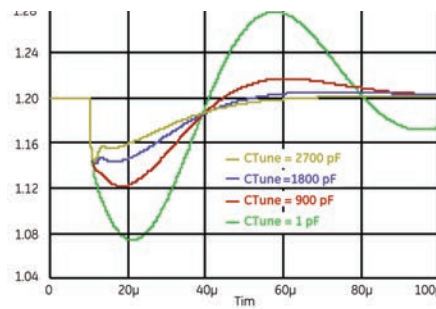
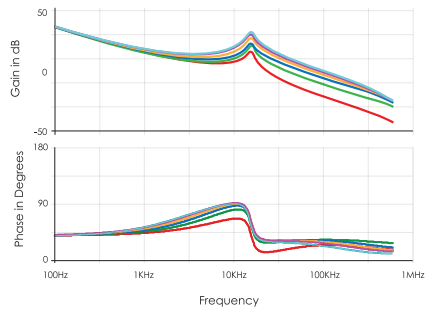

Tunable Loop* achieves lower voltage deviation with significantly reduced capacitance. As an example, the 12 A PicoDLynx* model (5 Vin / 1.2 V out @ 8 A), with a step load of 4 A and deviation <4% (48 mV) would require 3 ceramic caps + 4 electrolytic caps versus 1 ceramic cap + 1 electrolytic cap with Tunable Loop*. This voltage deviation results in a \$1.45 reduction in external capacitor cost and a footprint reduction of 190 mm² achieving 4x the effective current density.

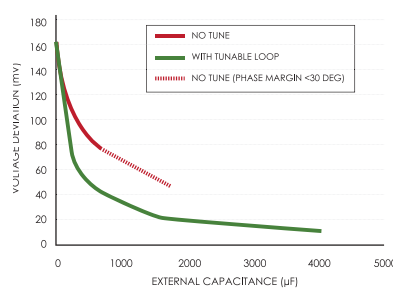

Tunable Loop* POL converter modules

DLynx* series

The ABB DLynx* offers digital control and communication in ultra-compact industry standard footprints. Multiple devices can use industry standard PMBus™ communication to monitor and optimize power conversion, even during operation, making Adaptive Voltage Scaling (AVS) a reality.













A minimum of three external components are needed to implement these modules, which leads to shortened design time. The ABB DLynx* family provides some of the most compact Point of Load DC-DC converters available with outstanding performance, control, and reliability at a cost competitive rate.

DLynx II* series

The new ABB DLynx II* extends our commitment to providing the digital power designer the latest tools and performance for power. Increased current, increased accuracy, extended PMBus™ command set and increased performance are all welcome tools for a dynamic and demanding industry. Ultimate density and competitive cost keep these new products at the forefront for the demanding designer.

- 2 to 40 A output current DLynx*
- 3 to 170 A output current DLynx II*

- >300 A with current sharing version TJT120P
- 4.5-14.4 Vdc input models
- 0.51 to 5.5 Vdc output models
- Dual offering—both digital & analog versions
- Standards-based DOSA footprint
- Tunable Loop*
- Digital communication (PMBus™)
- Total Efficiency* architecture
- Superior thermal performance
- EZ-Sequence*
- Cost efficient open frame design

	Model number	Input voltage	Output voltage	Output current	Comm.	Peak efficiency	Dimensions	Photo
PicoDLynx*	PNVX002	3.0-14.0 V	0.6-5.5 V	2 A	Analog	96%	12.2 x 12.2 x 4.5 mm	
	PDT003	3.0-14.4 V	0.45-5.5 V	3 A	Digital	94%	12.2 x 12.2 x 6.25 mm	
	PVX003	3.0-14.4 V	0.6-5.5 V	3 A	Analog	92%	12.2 x 12.2 x 6.25 mm	
	PDT006	3.0-14.4 V	0.45-5.5 V	6 A	Digital	94%	12.2 x 12.2 x 6.25 mm	
	PVX006	3.0-14.4 V	0.6-5.5 V	6 A	Analog	94%	12.2 x 12.2 x 6.25 mm	
	PDT012	3.0-14.4 V	0.45-5.5 V	12 A	Digital	96%	12.2 x 12.2 x 6.25 mm	
	PVX012	3.0-14.4 V	0.6-5.5 V	12 A	Analog	95%	12.2 x 12.2 x 6.25 mm	
MicroDLynx*	UDT020	3.0-14.4 V	0.45-5.5 V	20 A	Digital	96%	20.32 x 11.43 x 8.6 mm	
	UVT020	3.0-14.4 V	0.6-5.5 V	20 A	Analog	96%	20.32 x 11.43 x 8.6 mm	
MegaDLynx*	MDT040	4.5-14.4 V	0.45-2.0 V	40 A	Digital	91.5%	33.02 x 13.46 x 10.9 mm	
	MVT040	4.5-14.4 V	0.6-2.0 V	40 A	Analog	91.5%	33.02 x 13.46 x 10.9 mm	
FemtoDLynx II*	FKX003	4.5-14.0 V	0.6-5.5 V	3 A	Analog	93.5%	6.8 x 9 x 7.2 mm	
	FKX006	4.5-14.0 V	0.6-5.5 V	6 A	Analog	93.5%	6.8 x 9 x 7.2 mm	
PicoDLynx II*	PJT004	4.5-14.4 V	0.51-5.5 V	4 A	Digital	97.5%	12.2 x 12.2 x 7.5mm	
	PJT007	4.5-14.4 V	0.51-5.5 V	7 A	Digital	97.5%	12.2 x 12.2 x 7.5mm	
	PKX007	4.5-14.4 V	0.6-5.5 V	7 A	Analog	97.5%	12.2 x 12.2 x 7.5mm	
	PJT014	4.5-14.4 V	0.51-5.5 V	14 A	Digital	97%	12.2 x 12.2 x 7.5mm	
	PKX014	4.5-14.4 V	0.6-5.5 V	14 A	Analog	97%	12.2 x 12.2 x 7.5mm	
	PJT020	4.5-14.4 V	0.51-3.63 V	20 A	Digital	97%	12.2 x 12.2 x 8.5mm	
	PKX020	4.5-14.4 V	0.6-3.63 V	20 A	Analog	97%	12.2 x 12.2 x 8.5mm	
MicroDLynx II*	UJT035	4.5-14.4 V	0.51-3.63 V	35 A	Digital	97.25%	20.3 x 11.4 x 11mm	
GigaDLynx II*	GDT080	4.5-14.0 V	0.6-2.0 V	80 A	Digital	93%	33.02 x 22.86 x 12.7 mm	
TeraDLynx II*	TJT120	7.0-14.0 V	0.6-1.5 V	120 A	Digital	96%	54 x 31.8 x 13.6 mm	
	TJT170	7.0-14.0 V	0.6-1.5 V	170 A	Digital	96%	54 x 31.8 x 13.6 mm	

DualDLynx*-dual output digital DLynx*

The DualDLynx* non-isolated Point of Load (POL) DC-DC board-mounted power modules offer a new standard of power for space constrained boards. They offer up to 25 percent reduction in board space usage compared to previous and competing solutions. The Independent Power Train (IPT) feature provides two independent 12 A or 6 A outputs in a single module, enabling flexibility and reduced design time. Analog and digital options are available. The DualDLynx* has a PMBus™ digital interface for digital configuration, communication and control. Enhanced digital features reduce board space requirements and the need for external components.

- Independent Power Train feature enables flexibility and reduces design time
- PMBus™ digital interface supports wide range of commands (on/off, trim, digital sequencing, margin, power good, rise time adjustment and input under-voltage

lockout)

- The digital interface also offers output voltage, current and temperature measurement capabilities
- Ultra-tight voltage regulation (+/- 1 percent)
- Digital trim for power reduction and digital sequencing
- Over-temperature protection, output over-current protection (non-latching) and over-voltage protection
- Wide input voltage range: 4.5 Vdc-14.0 Vdc on both inputs
- New synchronization features and remote sensing make designing for strict noise and set point requirements easier and more accurate
- Small Micro footprint module (20.32 mm x 11.43 mm x 8.5 mm)
- Precisely regulated output voltage range of 0.51 to 5.5 VDC
- Wide range of design tools and technical support to decrease design time and improve time to market
- Digital loop compensation decreases board space, external components and cost
- Reliability measured in decades provides peace of mind

	Model number	Input voltage	Output voltage	Output current	Comm.	Dimensions	Photo
DualDLynx*	UDXS0606	4.5 Vdc-14.4 V	0.51 Vdc to 5.5 V	2 x 6 A	Digital	20.32 mm x 11.43 mm x 8.5 mm	
	UVXS0606	4.5 Vdc-14.4 V	0.6 Vdc to 5.5 V	2 x 6 A	Analog	20.32 mm x 11.43 mm x 8.5 mm	
	UDXS1212	4.5 Vdc-14.4 V	0.51 Vdc to 5.5 V	2 x 12 A	Digital	20.32 mm x 11.43 mm x 8.5 mm	
	UVXS1212	4.5 Vdc-14.4 V	0.6 Vdc to 5.5 V	2 x 12 A	Analog	20.32 mm x 11.43 mm x 8.5 mm	



SlimLynx* low profile series

The SlimLynx* series offers a slim, non-isolated DC-DC converter in a low profile height of 2.9 mm. It allows engineers to utilize this power module in very tight spaces, such as underneath the boards, in mezzanine structures, and in other low profile applications. A digital POL in an industry standard DOSA footprint, the SlimLynx* delivers exceptionally high efficiency peaking at more than 95%, which reduces energy consumption and heat dissipation.

- Ultra low height design for very dense power applications
- High technology encapsulation for improved thermal performance, electrical insulation, and easy

manufacturing

- Bottom side placement
- Digital interface through the PMBus™ protocol
- Small footprint: 12.2 x 12.2 x 2.9 mm
- Output voltage programmable from 0.6 to 5.5 Vdc via external resistor. Digitally adjustable down to 0.45 Vdc
- Wide Input voltage range (3-14.4 Vdc)
- Wide operating temperature range (-40°C to 85°C)
- DOSA approved footprint

	Model number	Input voltage	Output voltage	Output current	Comm.	Peak efficiency	Dimensions	Photo
SlimLynx*	PNDT003 (Pico)	3.0-14.4 V	0.45-5.5 V	3 A	Digital	95%	12.2 x 12.2 x 2.9mm	
	PNVT003 (Pico)	3.0-14.4 V	0.6-5.5 V	3 A	Analog	95%	12.2 x 12.2 x 2.9mm	
	PNDT006 (Pico)	3.0-14.4 V	0.45-5.5 V	6 A	Digital	95%	12.2 x 12.2 x 2.9 mm	
	PNVT006 (Pico)	3.0-14.4 V	0.6-5.5 V	6 A	Analog	95%	12.2 x 12.2 x 2.9 mm	
	PNDT012 (Pico)	3.0-14.4 V	0.45-5.5 V	12 A	Digital	96%	12.2 x 12.2 x 2.9 mm	
	PNVT012 (Pico)	3.0-14.4 V	0.6-5.5 V	12 A	Analog	96%	12.2 x 12.2 x 2.9 mm	

BoostLynx*

With two available product variants, High Voltage and Low Voltage, ABB Boost PoL provides voltage step-up from an input voltage of 8-16 Vdc to an output voltage of 16-34 or 32-54 Vdc. Boost PoL is suitable for a wide range of electronics products where some components require higher voltage than the typical 12 V bus. The Boost PoL can also be used to step up an existing 12 V bus to a 24 V or 48 V bus. Designing different interface cards with boost enables exchangeability of interface cards from the main system and provides more flexibility to the designer.



- Small, compact, board mounted 65 and 130 W boost converters
- Complete, easy to design module solution
- Optimized for conduction cooled applications for use in thermally demanding operating conditions with little or no airflow
- Wide input voltage range (8 Vdc-16 Vdc)
- Output voltage programmable from 16 to 54 Vdc via external resistor
- Tunable Loop* to optimize dynamic output voltage response
- Output overcurrent protection (non-latching)

	Model number	Input voltage	Output voltage	Output power	Comm.	Dimensions	Photo
BoostLynx* HV	ABXS001	8-16 V	32-54 V	65 W	Analog	27.9 mm x 11.4 mm x 9.0 mm	
BoostLynx* LV	ABXS002	8-16 V	16-34 V	65 W	Analog	27.9 mm x 11.4 mm x 7.5 mm	
BoostLynx* HV	ABX003	8-16 V	32-54 V	130 W	Analog	27.9 mm x 24 mm x 8.5 mm	
BoostLynx* LV	ABX005	8-16 V	16-34 V	130 W	Analog	27.9 mm x 24 mm x 8.5 mm	

ProLynx* wide input series

The ProLynx* series offers a wide input voltage range of 9 to 36 V and an extended output range of 3 to 18 V. It can also generate negative output voltages using an alternate connection scheme. These power modules simplify board design and accelerate new product development schedules by minimizing the designer's steps over choosing a discrete power solution. The ProLynx* can be used in a broad range of applications including automotive, industrial, medical, military, and wireless industries.



- Extra wide input voltage range (9 to 36 Vdc)
- Output voltage programmable from 3 to 18 Vdc via external resistor
- Tunable Loop* to optimize dynamic output voltage response
- Patent Pending AutoLimit automatic scaling of current limit with output voltage
- Can deliver 3 A to 12 A of output current
- Can deliver negative output voltage
- Output overcurrent protection (non-latching)
- Wide operating temperature range (-40°C to 105°C (Rugged: -D), 85°C (Regular))

	Model number	Input voltage	Output voltage	Output current	Comm.	Efficiency	Dimensions	Photo
ProLynx*	APXW003	9.0-36.0 V	3.0-18.0 V		Analog	97%	20.32 x 11.43 x 8.5 mm	
	APXW005	9.0-36.0 V 9.0-24 V	3.0-18.0 V -3.3 to -18 V	5 A	Analog	96%	20.32 x 11.43 x 8.5 mm	
	APXW012	9.0-36.0 V 9.0-24 V	3.0-18.0 V -3.3 to -18 V	12 A	Analog	97%	33.02 x 13.46 x 10.0 mm	

TLynx* surface mount models

The ABB TLynx* transformed the industry with the patented Tunable Loop* technology that dramatically reduced the total board space requirement while continuing to improve transient performance. TLynx* provides small size, proven reliability, great thermal performance, and cost

effectiveness. Only three external components are needed to complete a design, thereby reducing design time and increasing reliability. ABB TLynx* family provides a high performance Point of Load solution with a minimum of risk, time and cost. 30 A and 50 A TLynx* converters can be paralleled.

	Model number	Input voltage	Output voltage	Output current	Efficiency	Dimensions	Photo
PicoTLynx*	APXS002	3.0-14 V	0.6-5.5 V	2 A	96%	12.2 x 12.2 x 6.25 mm	
	APXK004	8.0-16 V	0.6-8.0 V	4 A	96%	12.2 x 12.2 x 6.25 mm	
MegaTLynx*	APTS030	6.0-14 V	0.80-3.63 V	30 A	96%	33 x 13.46 x 10.0 mm	
GigaTLynx*	APTS050	4.5 -14.0 V	0.7-2.0 V	50 A	95%	33 x 22.9 x 10.0 mm	

Naos Raptor* single in-line package (SIP)

The ABB Naos Raptor* family offers the high-performance features of Tunable Loop*, excellent thermal performance, and proven ABB reliability in a SIP package, which requires a minimum of board space.

	Model number	Input voltage	Output voltage	Output current	Efficiency	Dimensions	Photo
BoostLynx* HV	NQR002	3.0-14 V	0.6-5.5 V	2 A	93%	10.4 x 16.5 x 8.1 mm	
	NSR003	4.5-14 V	0.59-6 V	3 A	93%	10.4 x 16.5 x 7.84 mm	
	NSR006	4.5-14 V	0.59-6 V	6 A	92%	10.4 x 16.5 x 7.84 mm	
	NQR010	4.5-14 V	0.59-6 V	10 A	97%	10.4 x 16.5 x 8.4 mm	
	NSR020	4.5-13.8 V	0.59-6 V	20 A	97%	36.8 x 15.5 x 9.2 mm	
	NSR040	5.0-13.8 V	0.60-5 V	40 A	95%	36.8 x 27.9 x 10.7 mm	
	NSR060	5.0-13.8 V	0.60-5 V	60 A	95%	65.5 x 31.8 x 11.6 mm	



Digital power solutions

Digital converters

ABB digitally-controlled DC-DC power converters provide power engineers with a broad range of modules supported by a suite of information and tools to innovate their designs. Digital models offer more flexibility, often require less real estate, and deliver higher performance at an attractive price. The true power of digital communication becomes apparent when measurements and adjustments can be made instantaneously. Digital modules provide the ability to diagnose and refine designs prior to final production, monitor and adjust running product and deliver exceptional thermal de-rating. Digital solutions combine voltage range accuracy while consuming less board space at competitive costs. The non-isolated DLynx* and DLynx II* families and the isolated Barracuda* family offer both an industry-standard DOSA footprint to ensure hardware compatibility and a standard PMBus™ interface to ensure software compatibility to minimize risk for future designs.

DLynx*

The DLynx* portfolio is available in 3 A, 6 A, 12 A, 20 A, and 40 A digital and analog versions. The DC-DC POL converters efficiently power circuit board electronics such as processors, memory, application-specific integrated circuits (ASICs), field programmable gate arrays (FPGAs) and other silicon devices. The standards-based DOSA footprints and analog/digital compatibility with existing circuit board designs shrinks the size, lowers the cost and improves the performance of DC-DC converter modules. An industry-standard PMBus™ interface and space-saving Tunable Loop* technology deliver leading current density. With proven tools to simplify design, DLynx* modules can be implemented with only three external components. Adaptive voltage scaling (AVS) leverages silicon performance to reduce power consumption through tight digital control (± 0.4 percent) of the output voltage and a ± 1 percent

controller set point reference.

DLynx II*

The new, digital DLynx II* modules offer a glimpse into the future. ABB's second generation of digital POLs bring even tighter setpoint accuracy ($\pm 0.5\%$), tighter reporting accuracy, extended PMBus™ command set, and only one external component needed for the Digital Tunable Loop* compensation. New control schemes offer the ability to customize performance to tailor these modules to an even wider range of applications. DLynx II* are available in 3, 6, 7, 14, 20, 35, 80, 120, and 170 A modules. 120 A unit supports current sharing for up to 3 paralleling units.

Barracuda*

The cost-effective, high-efficiency Barracuda* series delivers digital power communication and control in a quarter-brick and eighth-brick DOSA standard footprint. Power design engineers can deploy the new Barracuda* modules in existing power designs as DOSA-compliant, drop-in upgrades for unregulated and semi-regulated bus converters. As part of the Total Efficiency* architecture, the new Barracuda* modules deliver peak efficiency of up to 96 percent. A new digital PMBus™ interface supports a wide range of commands to both control and monitor the Barracuda* modules with a full range of protections and warnings, digital on/off, trim, margin, power good, rise time adjustment, and input under voltage lockout.

SlimLynx*

The SlimLynx* is a new series of low profile, digital and analog, non-isolated, DC-DC converters from ABB. The ultra-slim 2.9 mm module provides industry-leading power density to reduce heat dissipation inside industrial, networking and telecommunication devices, while also delivering exceptionally high energy efficiency, peaking at more than 95%. The SlimLynx* modules were designed with space constraints in mind and are perfect for back-of-board placement and in places with limited height restrictions, like under daughter boards. The new Pico size SlimLynx* almost doubles the density of the first generation.



Custom capabilities

Our customer focus

ABB maintains a broad range of standard technologies that are the ideal building blocks to solve your application's power requirements. Many of our customers want us to re-package our technologies to develop an optimal solution that maximizes performance while reducing their total cost of ownership. We quickly and cost effectively employ our leading-edge technologies to deliver custom products that best fit our customer's unique power requirements—reducing their risk and time to market by utilizing proven technologies.

Talent

ABB retains independent Research & Development and Custom Product Development teams to ensure both continued development of next generation technology road maps as well as custom / modified designs. We are self-certified to support major safety agencies, further reducing product development schedules.

Our regional Field Application Engineers (FAEs) work closely with our customers to rapidly produce clean engineering prototypes, and, along with our design teams, provide ongoing sales and technical support throughout the life of each application. Our closed-loop engineering processes ensure continued process improvements and new technology trends are implemented into our future designs.

Research & design

ABB maintains strategic alliances with key suppliers and global industry leaders to help define future technology direction and objectives. Our alliances allow us greater utilization of next generation technologies and topologies that we deploy into our custom power designs to drive lead-

ing power densities and efficiencies for our customers.

Product development

Once a solution is proven at the prototype level, our product development teams execute a full development process finalizing the design and implementing improvements to the fabricated parts (such as PCBs, sheet metal, and magnetics), confirming the bill of materials, defining the quality assurance metrics, performing design verification tests, performing reliability tests (HALT / STRIFE), and testing for certification and EMI / safety qualification.

Manufacturing & quality control

Our global operations and standardized processes enable us to build product at any of our global facilities utilizing consistent processes, equipment, training, and quality standards ensuring our customers receive exceptional products regardless of the country of design or manufacture. Our consistent approach ensures product quality,



Facilities

Our manufacturing strategy is to use the best of both internal and third party manufacturing, allowing us the flexibility to best fit each application's requirements. Our manufacturing processes, quality systems, data collection, and documentation are standardized across all facilities ensuring a smooth transition among locations to accommodate optimal capacity utilization and/or proximity of supply close to our end customer's manufacturing location. Employing a global procurement strategy further underscores our commitment to our customers. Managing a common AVL across all divisions allows us to leverage our cost structure with our supplier base, which contributes to competitive products with cost savings for our customers.

Quality / reliability

Our Global Total Quality Management System ensures consistent measurement and collection of SPC data and deployment of controls of operation. Starting with the design and development phase, we apply stringent derating criteria of components and expose our designs to STRIFE and HALT testing. Our focus on reliability continues into production by using HASS screening and elevated temperature testing. Finally, we monitor the process using CPK and statistical analysis tools, forming a closed-loop process. All of our facilities are ISO 9001:2000 and ISO14001 Certified with many of our Quality Managers holding Green and Black Belt Six Sigma ratings. As a leading power provider, we offer our customers low-risk, leading-edge technology and consistent, high-quality product produced around the world and backed up by responsive local support.

Engineering resources & tools

Power Module Wizard

This cloud-based tool helps board designers to easily select the best part for their design, thus improving design productivity and reducing design risk. From a simple set of requirements entered by the user, the tool quickly provides a list of suitable parts that can be sorted by different characteristics such as efficiency, size and/or cost. The results table also provides a summary of part parameters as well as links to the data sheet. For many parts, after selection, a simplified circuit schematic around the module can be created that is then analyzed via multiple simulation tools to evaluate important performance parameters such as efficiency, input and output ripple, static output voltage variation, transient response and circuit stability. Once satisfactory performance is obtained via simulation, a bill of materials with estimated pricing can be generated by the tool providing designers with the information needed to move towards production. Finally, the tool being Web-based allows for easy sharing of design information with designer colleagues and FAEs allowing for quick review and discussion.

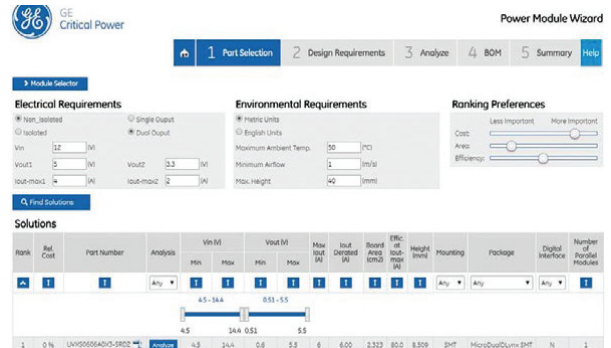

Digital Power Insight* tools

The Digital Power Insight (DPI) software suite allows customers to communicate with ABB's latest Digital AC-DC and DC-DC power supplies, Digital Bus Converters and Point-of-Load (POL) modules, without having to write any software. With the ABB USB-to-I²C adapter, and a set of four tools (command line interface based DPI-CLI; a simple, fixed-format graphical user interface DPI-GUI for modules and Bus Converters and CPGUI for the CP family products and the full-featured, multi-window ProGUI), the user has a rich set of capabilities to use in their system development and testing.

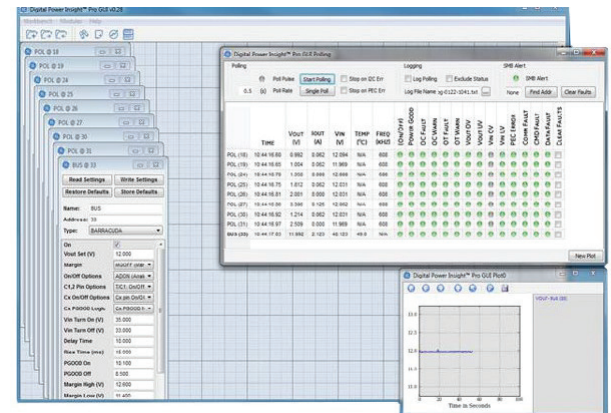

ProGUI

The new ProGUI enhances the capability of the Digital Power Insight* software suite with a powerful tool capable of communicating with up to 64 modules on the PMBus™. Features include configuring modules, logging and plotting data obtained from the modules, and saving data for further analysis and documentation. The ProGUI, along with the previously available GUI and Command Line Interface (CLI) software tools, provide the user with a wide range of capabilities to communicate with digital modules during the design phase as well as with production boards. The tool supports ABB digital DC-DC Modules, AC-DC & DC-DC Power Supplies. The ProGUI can also remotely update firmware and

retrieve black box measurements from the newer generation ABB Power Supplies that support this feature.

Evaluation boards

Evaluation boards enable designers to evaluate the performance of our converters, either stand-alone or with our POL modules and optional input filters. Features such as on/off control, output voltage trim, and remote sense can be tested as well as external filtering components on both the input and output side.

Digital evaluation kits

Digital Power Insight Kit

ABB Digital Power Insight* (DPI) kit provides an easy to use vehicle for customers to explore the use of digital power and PMBus™. The hardware provides a set of example modules on evaluation boards along with a USB-to-I²C adapter and DPI software to experiment with monitoring of various module parameters (like input and output voltage, output current, module temperature) and module status. This kit provides an excellent way for new users to digital power to learn about this exciting new capability in ABB power supplies.



AC-DC and DC-DC power supplies

$I_{OUT} \backslash V_{OUT}$	380 V	65 V	58 V	54 V	53 V	52 V	48 V	32 V	28 V	24 V	23V	18 V	12 V	5 V
250 A													CAR3012TE	
208 A													CAR2512TE	
													CAR2512DC	
166 A													CAR2012TE	
150 A													CAR1812FP	
133 A													CAR1612FP	
100 A				GP100H3R48TEZ* (3 phase, RS485)									CAR1212FP	
				GP100H3M54TEZ (3 phase, I ² C)									CAR1212DC	
			GP100H3M50TEZ-FB											
83.3 A										CAR2024FP				
70.8 A													CAR0812FP	
													CAR0812DC	
65 A			CP3500AC52TEZ-FB2											
			CC3500ACAC52FB2											
		CP3500AC65TEZ												
			CP3500AC54TEZ/CZ											
62.5 A													SLP0712TE	
60 A						EP3000AC48							MPR0712TE	
55 A				CP3000AC54TEZ-FSG(R)										
				CP3000AC54TEZ/CZ										
				CP3000AC54TEPZ-F										
52 A													CAR2548FP	
													CAR2548TN	
													CAR2548DC	
50 A				CP2725AC54TEZ/P										
				CP2700AC52TEZ-FB2										
				CP2725AC48TEZ-FB										
45 A				CP2500DC54PEZ										CLP0512FP
				CP2500DC54PEZ-F										CAR0512FP
41.6 A													CCR0512FP	
40 A				CP2000AC54TEZ/P										CLP0205FP
				CP2000DC54PEZ										
37.5 A													CLP0412FP	
33 A	CC12500H3C380TEZ-GM													
	CH12500H3C380TEZ-GM													
31.25 A													CAR0924FP	
30 A						EP1600UTEZ								
25 A													CAR1248FP	
													CAR1248TN	

I _{OUT} \ V _{OUT}	380 V	65 V	58 V	54 V	53 V	52 V	48 V	32 V	28 V	24 V	18 V	12 V	5 V
20 A					EP1000UTEZ					EP0500V			
18.75 A										CLP0424FP			
16.6 A	MPR0854FP									CAR0424FP		CLP0212	
12.5 A												CLP0112	
10 A					EP0500U					CLP0224			
9.4 A						CLP0448FP							

* 48 V or 54 V default V out available

EP Rectifier (AC in)	CLP (Open Frame, AC in)	CCR (1/2 U)
CP Rectifier (AC in)	CP Converter (DC in)	GP Rectifier (AC in)
CAR Rectifier (AC in)	CAR Converter (DC in)	SLP (1Ux1U)
CP Short Rectifier (AC or HVDC in)	CC Rectifier (AC in)	CH Rectifier (AC in)

www.geindustrial.com/products/embedded-power/ac-dc-power-supplies

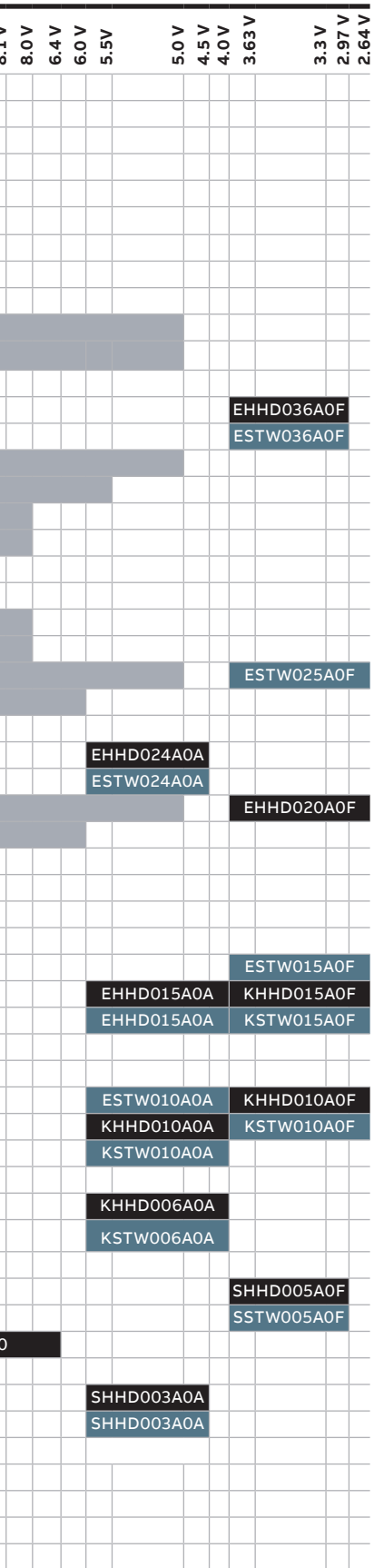

First Letter	Package	Third Letter	Comm Interface
S	1x1 brick	D	DOSA PMBus
K	1/16th brick	V and all others	DOSA Analog
Q	1/4 brick		
N	1/2 brick		
F	full brick		

ProLynx* (9-36Vin)	BARRACUDA* HIGH (Vin = other)
BARRACUDA* HIGH (Vin = 38-55 V)	HAMMERHEAD* (18-75 Vin)
BARRACUDA* HIGH (Vin = 40-60 V)	BARRACUDA* LOW (36-75 Vin)
BARRACUDA* HIGH (Vin = 36-75 V)	ORCA* (36-75 Vin)

	54 V	34 V	32 V	18 V	16 V	8 V	6 V	5.5 V	5 V	3.6 V	3 V	2 V	1.5 V	.7 V	.6 V	.51 V	.45 V		
3 A								FKX003											
								PNDT003†											
								PNVT003											
								PDT003†											
								PVX003											
								NSR003											
2 A	ABXS003							APXS002											
								PNVX002											
								NQR002											
		ABXS002																	
1 A	ABXS001																		

First Letter	Package
F	Femto (6.8 x 9 mm)
P	Pico (12 x 12 mm)
M	Mega (33x13 mm)
G	Giga (33 x 23 mm)
T	Tera (54 x 32 mm)
A	Varies
N	SIP, varies

† PMBus Digital

ProLynx* (9-36 Vin)	TLynx* (Vin varies)
SlimLynx* (3-14.4 Vin)	Naos Raptor* (SIP, Vin varies)
DLynx* (3-14.4 Vin)	Dual DLynx* (4.5-14.4 Vin)
DLynx II*	BoostLynx* (8-16 Vin)

www.geindustrial.com/products/embedded-power/non-isolated-dcdc-converters



ABB Inc.

601 Shiloh Road
Plano, TX 75074
USA
+1 877 546 3243

Go.ABB/Industrial

