



# Enterprise Capacity 3.5 HDD

v5 SATA Product Manual

## **Standard 512N models**

ST4000NM0035  
ST3000NM0005  
ST2000NM0055  
ST1000NM0055

## **Self-Encryption 512N models**

ST4000NM0045  
ST3000NM0015  
ST2000NM0065  
ST1000NM0065

## **SED-FIPS 140-2 models**

ST4000NM0105  
ST3000NM0055

100793636, Rev. A

March 2016

## Document Revision History

Revision	Date	Pages affected and Description of changes
Rev. A	03/22/2016	Initial release.

**© 2016 Seagate Technology LLC. All rights reserved.**

Publication number: 100793636, Rev. A March 2016

Seagate, Seagate Technology and the Spiral logo are registered trademarks of Seagate Technology LLC in the United States and/or other countries. PowerChoice and SeaTools are either trademarks or registered trademarks of Seagate Technology LLC or one of its affiliated companies in the United States and/or other countries. The FIPS logo is a certification mark of NIST, which does not imply product endorsement by NIST, the U.S., or Canadian governments. All other trademarks or registered trademarks are the property of their respective owners.

No part of this publication may be reproduced in any form without written permission of Seagate Technology LLC.

Call 877-PUB-TEK1 (877-782-8351) to request permission.

When referring to drive capacity, one gigabyte, or GB, equals one billion bytes and one terabyte, or TB, equals one trillion bytes. Your computer's operating system may use a different standard of measurement and report a lower capacity. In addition, some of the listed capacity is used for formatting and other functions, and thus will not be available for data storage. Actual quantities will vary based on various factors, including file size, file format, features and application software. Actual data rates may vary depending on operating environment and other factors. The export or re-export of hardware or software containing encryption may be regulated by the U.S. Department of Commerce, Bureau of Industry and Security (for more information, visit [www.bis.doc.gov](http://www.bis.doc.gov)), and controlled for import and use outside of the U.S. Seagate reserves the right to change, without notice, product offerings or specifications.

# Contents

<b>Seagate® Technology Support Services</b> .....	<b>4</b>
---------------------------------------------------	----------

---

<b>1.0 Introduction</b> .....	<b>5</b>
1.1 About the Serial ATA interface .....	5

---

<b>2.0 Drive specifications</b> .....	<b>6</b>
2.1 Specification summary tables .....	6
2.2 Formatted capacity .....	8
2.2.1 LBA mode .....	8
2.3 Recording and interface technology .....	8
2.4 Start/stop times .....	8
2.5 Power specifications .....	9
2.5.1 Power consumption .....	9
2.5.2 Conducted noise .....	12
2.5.3 Voltage tolerance .....	12
2.5.4 Extended Power Conditions - PowerChoice™ .....	12
2.6 Environmental limits .....	14
2.6.1 Temperature .....	14
2.6.2 Humidity .....	14
2.6.3 Effective Altitude (sea level) .....	14
2.6.4 Shock .....	15
2.6.5 Vibration .....	15
2.7 Acoustics .....	16
2.8 Test for Prominent Discrete Tones (PDTs) .....	16
2.9 Electromagnetic immunity .....	16
2.10 Reliability .....	17
2.10.1 Annualized Failure Rate (AFR) and Mean Time Between Failures (MTBF) .....	17
2.11 Agency certification .....	17
2.11.1 Safety certification .....	17
2.11.2 Electromagnetic compatibility .....	17
2.11.3 FCC verification .....	18
2.12 Environmental protection .....	19
2.12.1 European Union Restriction of Hazardous Substances (RoHS) Directive .....	19
2.12.2 China Restriction of Hazardous Substances (RoHS) Directive .....	19
2.13 Corrosive environment .....	19
2.14 Reference documents .....	20
2.15 Product warranty .....	20

---

<b>3.0 Configuring and mounting the drive</b> .....	<b>21</b>
3.1 Handling and static-discharge precautions .....	21
3.2 Configuring the drive .....	21
3.3 Serial ATA cables and connectors .....	21
3.4 Drive mounting .....	21
3.4.1 Mechanical specifications .....	22

---

<b>4.0 About self-encrypting drives</b> .....	<b>23</b>
4.1 Data encryption .....	23
4.2 Controlled access .....	23
4.2.1 Admin SP .....	23
4.2.2 Locking SP .....	23
4.2.3 Default password .....	23
4.3 Random number generator (RNG) .....	24
4.4 Drive locking .....	24
4.5 Data bands .....	24
4.6 Cryptographic erase .....	24

# Contents

4.7	Authenticated firmware download .....	24
4.8	Power requirements .....	25
4.9	Supported commands .....	25
4.10	RevertSP .....	25
4.11	ATA Security Erase Unit Command on SED SATA drives .....	25
4.12	Sanitize Device - CRYPTO SCRAMBLE EXT .....	25
<hr/>		
<b>5.0</b>	<b>About FIPS .....</b>	<b>26</b>
<hr/>		
<b>6.0</b>	<b>Serial ATA (SATA) interface .....</b>	<b>27</b>
6.1	Hot-Plug compatibility .....	27
6.2	Serial ATA device plug connector pin definitions .....	27
6.3	Supported ATA commands .....	28
6.3.1	Identify Device command .....	30
6.3.2	Set Features command .....	33
6.3.3	S.M.A.R.T. commands .....	34

# Seagate® Technology Support Services

For information regarding online support and services, visit: <http://www.seagate.com/contacts/>

For information regarding Warranty Support, visit: <http://www.seagate.com/support/warranty-and-replacements/>

For information regarding data recovery services, visit: <http://www.seagate.com/services-software/data-recovery-services/>

For Seagate OEM, Distribution partner and reseller portals, visit: <http://www.seagate.com/partners>

# 1.0 Introduction

This manual describes the functional, mechanical and interface specifications for the following:  
Seagate® Enterprise Capacity 3.5 HDD v5 Serial ATA model drives:.

Standard 512N models	Self-Encrypting 512N (SED) models	SED FIPS 140-2 512N Drive
ST4000NM0035	ST4000NM0045	ST4000NM0105
ST3000NM0005	ST3000NM0015	ST3000NM0005
ST2000NM0055	ST2000NM0065	
ST1000NM0055	ST1000NM0065	

These drives provide the following key features:

- 128 MB data buffer.
- 7200 RPM spindle speed.
- Full-track multiple-sector transfer capability without local processor intervention.
- High instantaneous (burst) data-transfer rates (up to 600MB per second).
- Native Command Queuing with command ordering to increase performance in demanding applications.
- Perpendicular recording technology provides the drives with increased areal density.
- PowerChoice™ for selectable power savings
- SeaTools™ diagnostic software performs a drive self-test that eliminates unnecessary drive returns.
- State-of-the-art cache and on-the-fly error-correction algorithms.
- Support for S.M.A.R.T. drive monitoring and reporting.
- Supports latching SATA cables and connectors.
- Tarnish-resistant components to help protect drive from environmental elements, increasing field reliability.
- Top Cover Attached motor for excellent vibration tolerance
- Worldwide Name (WWN) capability uniquely identifies the drive.

<b>Note</b>	Seagate recommends validating the configuration with the selected HBA/RAID controller manufacturer to ensure use of full capacity is supported.
-------------	-------------------------------------------------------------------------------------------------------------------------------------------------

## 1.1 About the Serial ATA interface

The Serial ATA interface provides several advantages over the traditional (parallel) ATA interface. The primary advantages include:

- Easy installation and configuration with true plug-and-play connectivity.  
It is not necessary to set any jumpers or other configuration options.
- Thinner and more flexible cabling for improved enclosure airflow and ease of installation.
- Scalability to higher performance levels.

In addition, Serial ATA makes the transition from parallel ATA easy by providing legacy software support. Serial ATA was designed to allow users to install a Serial ATA host adapter and Serial ATA disk drive in the current system and expect all of the existing applications to work as normal.

The Serial ATA interface connects each disk drive in a point-to-point configuration with the Serial ATA host adapter. There is no master/slave relationship with Serial ATA devices like there is with parallel ATA. If two drives are attached on one Serial ATA host adapter, the host operating system views the two devices as if they were both “masters” on two separate ports. This essentially means both drives behave as if they are Device 0 (master) devices.

<b>Note</b>	The host adapter may, optionally, emulate a master/slave environment to host software where two devices on separate Serial ATA ports are represented to host software as a Device 0 (master) and Device 1 (slave) accessed at the same set of host bus addresses. A host adapter that emulates a master/slave environment manages two sets of shadow registers. This is not a typical Serial ATA environment.
-------------	---------------------------------------------------------------------------------------------------------------------------------------------------------------------------------------------------------------------------------------------------------------------------------------------------------------------------------------------------------------------------------------------------------------

The Serial ATA host adapter and drive share the function of emulating parallel ATA device behavior to provide backward compatibility with existing host systems and software. The Command and Control Block registers, PIO and DMA data transfers, resets, and interrupts are all emulated.

The Serial ATA host adapter contains a set of registers that shadow the contents of the traditional device registers, referred to as the Shadow Register Block. All Serial ATA devices behave like Device 0 devices. For additional information about how Serial ATA emulates parallel ATA, refer to the “Serial ATA: High Speed Serialized AT Attachment” specification. The specification can be downloaded from [www.serialata.org](http://www.serialata.org).

## 2.0 Drive specifications

Unless otherwise noted, all specifications are measured under ambient conditions, at 25°C, and nominal power. For convenience, the phrases *the drive* and *this drive* are used throughout this manual to indicate the following drive models:

Standard 512N models	Self-Encrypting 512N (SED) models	SED FIPS 140-2 512N Drive
ST4000NM0035	ST4000NM0045	ST4000NM0105
ST3000NM0005	ST3000NM0015	ST3000NM0005
ST2000NM0055	ST2000NM0065	
ST1000NM0055	ST1000NM0065	

### 2.1 Specification summary tables

The specifications listed in the following tables are for quick reference. For details on specification measurement or definition, see the appropriate section of this manual.

**Table 1 Drive specifications summary**

Drive specification	ST4000NM0035 ST4000NM0045 ST4000NM0105	ST3000NM0005 ST3000NM0015 ST3000NM0005	ST2000NM0055 ST2000NM0065	ST1000NM0055 ST1000NM0065
Formatted (512 bytes/sector)*	4TB	3TB	2TB	1TB
Guaranteed sectors	(see <a href="#">Section 2.2</a> )			
Heads	7		4	2
Discs	4		2	
Bytes per logical sector	512			
Recording density, KBPI (Kb/in max)	2018			
Track density, KTPI (ktracks/in avg.)	369			
Areal density, (Gb/in <sup>2</sup> avg)	732			
Spindle speed (RPM)	7200			
Internal data transfer rate (Mb/s max)	2396			
Sustained data transfer rate OD (MiB/s max)	216 (226 MB/s max)			
I/O data-transfer rate (MB/s max)	600			
ATA data-transfer modes supported	PIO modes 0–4 Multiword DMA modes 0–2 Ultra DMA modes 0–6			
Cache buffer	128MB (129,536KB)			
Weight: (maximum)	704g (1.55 lb)		610g (1.34 lb)	
Average latency	4.16ms			
Power-on to ready (sec) (typ/max)	22/30			
Standby to ready (sec) (typ/max)	22/30			
Startup current (typical) 12V (peak)	2.6A 2.0A (optional configuration through Smart Command Transport)			
Voltage tolerance (including noise)	5V +10/-5% 12V ±10%			
Non-Operating ambient temperature (°C)	–40 to 70			
Operating ambient temperature (°C)	5			
Operating temperature (Drive case max °C)	60			
Temperature gradient (°C per hour max)	20°C (operating) 30°C (nonoperating)			
Relative humidity	5% to 95% (operating) 5% to 95% (nonoperating)			
Relative humidity gradient	30% per hour max			
Altitude, operating	–304.8 m to 3,048 m (–1000 ft to 10,000+ ft)			
Altitude, nonoperating (below mean sea level, max)	–304.8 m to 12,192 m (–1000 ft to 40,000+ ft)			
Operational Shock (max at 2 ms)	Read 70 Gs / Write 40 Gs			
Non-Operational Shock (max at 2 ms)	300 Gs			

Drive specification	ST4000NM0035 ST4000NM0045 ST4000NM0105	ST3000NM0005 ST3000NM0015 ST3000NM0005	ST2000NM0055 ST2000NM0065	ST1000NM0055 ST1000NM0065
Vibration, operating	5–22 Hz: 0.25 Gs, Limited displacement 22–350 Hz: 0.50 Gs 350–500 Hz: 0.25 Gs			
Operation Rotational vibration	20–1500Hz: 12.5 rads/s <sup>2</sup>			
Vibration, nonoperating	10–500 Hz: 4.9 Grms ref			
Drive acoustics, sound power (bels)				
Idle**	2.8 (typical) 3.0 (max)			
Performance seek	3.2 (typical) 3.4 (max)			
Nonrecoverable read errors	1 sector per 10 <sup>15</sup> bits read			
Annualized Failure Rate (AFR)	0.44% based on 8760 POH			
Maximum Rated Workload	Maximum rate of <550TB/year. Workloads exceeding the annualized rate may degrade the drive MTBF and impact product reliability. The Annualized Workload Rate is in units of TB per year, or TB per 8760 power on hours. Workload Rate = TB transferred * (8760 / recorded power on hours).			
Warranty	To determine the warranty for a specific drive, use a web browser to access the following web page: <a href="http://www.seagate.com/support/warranty-and-replacements/">http://www.seagate.com/support/warranty-and-replacements/</a> . From this page, click on the "Is my Drive under Warranty" link. The following are required to be provided: the drive serial number, model number (or part number) and country of purchase. The system will display the warranty information for the drive.			
Load-unload cycles	600,000			
Supports Hotplug operation per Serial ATA Revision 3.2 specification	Yes			

\*One GB equals one billion bytes when referring to hard drive capacity. Accessible capacity may vary depending on operating environment and formatting.

\*\*During periods of drive idle, some offline activity may occur according to the S.M.A.R.T. specification, which may increase acoustic and power to operational levels.



## 2.2 Formatted capacity

ST models	Formatted capacity*	Guaranteed sectors	Bytes per logical sector
ST4000NM0035 ST4000NM0045 ST4000NM0105	4TB	7,814,037,168	512
ST3000NM0005 ST3000NM0015 ST3000NM0055	3TB	5,860,533,168	
ST2000NM0055 ST2000NM0065	2TB	3,907,029,168	
ST1000NM0055 ST1000NM0065	1TB	1,953,525,168	

\*One GB equals one billion bytes when referring to hard drive capacity. Accessible capacity may vary depending on operating environment and formatting.

### 2.2.1 LBA mode

When addressing these drives in LBA mode, all blocks (sectors) are consecutively numbered from 0 to  $n-1$ , where  $n$  is the number of guaranteed sectors as defined above.

See Section 6.3.1, "Identify Device command" (words 60-61 and 100-103) for additional information about 48-bit addressing support of drives with capacities over 137GB.

## 2.3 Recording and interface technology

Interface	Serial ATA (SATA)
Recording method	Perpendicular
Recording density, KBPI (Kb/in max)	2018
Track density, KTPI (ktracks/in avg)	369
Areal density (Gb/in <sup>2</sup> avg)	732
Spindle speed (RPM) ( $\pm 0.2\%$ )	7200
Internal data transfer rate (Mb/s max)	2396
Sustained data transfer rate (MiB/s max)	216
I/O data-transfer rate (MB/s max)	600 (Ultra DMA mode 5)

## 2.4 Start/stop times

Power-on to Ready (sec) (typ/max)	22/30
Standby to Ready (sec) (typ/max)	22/30
Ready to spindle stop (sec) (max)	23

## 2.5 Power specifications

The drive receives DC power (+5V or +12V) through a native SATA power connector. See Figure 4 on page 21.

### 2.5.1 Power consumption

Power requirements for the drives are listed in Table 2 through Table 3. Typical power measurements are based on an average of drives tested, under nominal conditions, using 5.0V and 12.0V input voltage at 25°C ambient temperature.

**Table 2 DC power requirements (3TB and 4TB)**

		6.0Gb mode		
Voltage		+5V	+12V	Watts
Regulation		± 5%		Total
<b>Avg Idle Current *</b>		0.205	0.369	5.45
<b>Advanced Idle Current *</b>				
	Idle_A	0.200	0.366	5.39
	Idle_B	0.133	0.330	4.63
	Idle_C	0.141	0.202	3.13
	Standby	0.125	0.001	0.63
<b>Maximum Start Current</b>				
	DC (peak DC)	0.491	2.095	
	AC (Peak DC)	0.680	2.680	
Delayed Motor Start (DC max)		0.176	0.068	1.70
<b>Operating current (random read): 4K/Q16</b>				
	Typical DC	0.234	0.724	9.86
	Maximum DC	0.238	0.734	10.00
<b>Operating current (random write): 4K/Q16</b>				
	Typical DC	0.245	0.692	9.52
	Maximum DC	0.248	0.701	9.65
<b>Operating current (sequential read): 64K/Q16</b>				
	Typical DC	0.505	0.402	7.35
	Maximum DC	0.512	0.407	7.45
<b>Operating current (sequential write): 64K/Q16</b>				
	Typical DC	0.443	0.427	7.33
	Maximum DC	0.448	0.430	7.40

\*During periods of drive idle, some offline activity may occur according to the S.M.A.R.T. specification, which may increase acoustic and power to operational levels

**Table 3 2-1TB Drive DC power requirements**

		6.0Gb mode		
Voltage		+5V	+12V	Watts
Regulation		± 5%		Total
<b>Avg Idle Current *</b>		0.20	0.271	4.25
<b>Advanced Idle Current *</b>				
	Idle_A	0.197	0.270	4.22
	Idle_B	0.128	0.244	3.57
	Idle_C	0.137	0.156	2.56
	Standby	0.120	0.011	0.74
<b>Maximum Start Current</b>				
	DC (peak DC)	0.466	2.046	
	AC (Peak DC)	0.608	2.72	
Delayed Motor Start (DC max)		0.144	0.02	0.96
<b>Operating current (random read): 4K/Q16</b>				
	Typical DC	0.22	0.628	8.64
	Maximum DC	0.228	0.644	8.86
<b>Operating current (random write): 4K/Q16</b>				
	Typical DC	0.231	0.599	8.34
	Maximum DC	0.239	0.623	8.67
<b>Operating current (sequential read): 64K/Q16</b>				
	Typical DC	0.491	0.291	5.95
	Maximum DC	0.497	0.299	6.07
<b>Operating current (sequential write): 64K/Q16</b>				
	Typical DC	0.431	0.31	5.87
	Maximum DC	0.438	0.317	5.99

\*During periods of drive idle, some offline activity may occur according to the S.M.A.R.T. specification, which may increase acoustic and power to operational levels.

### 2.5.1.1 Typical current profiles

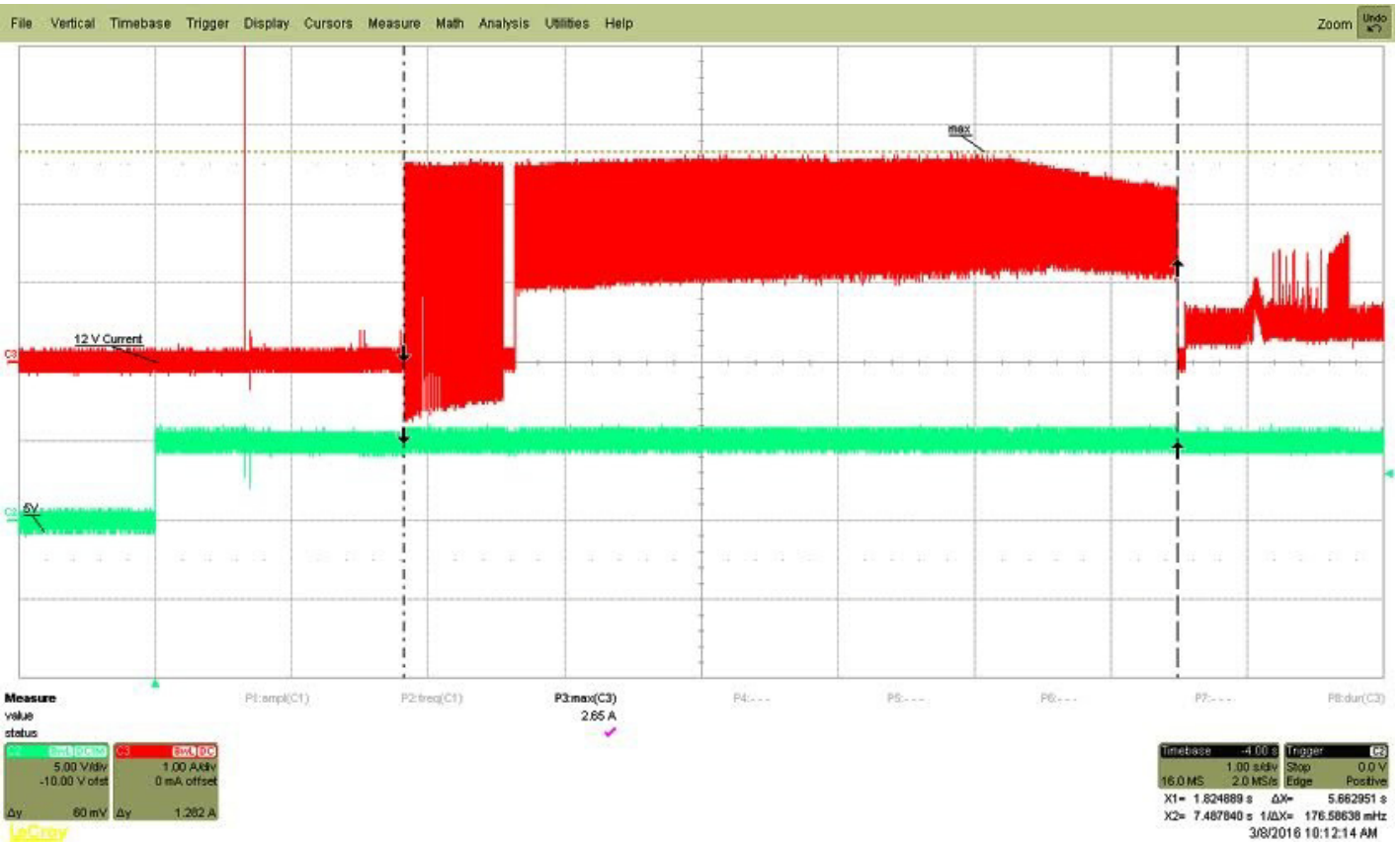

Figure 1. 4TB Typical 5V and 12V startup and operation current profile

### 2.5.1.2 Typical current profiles

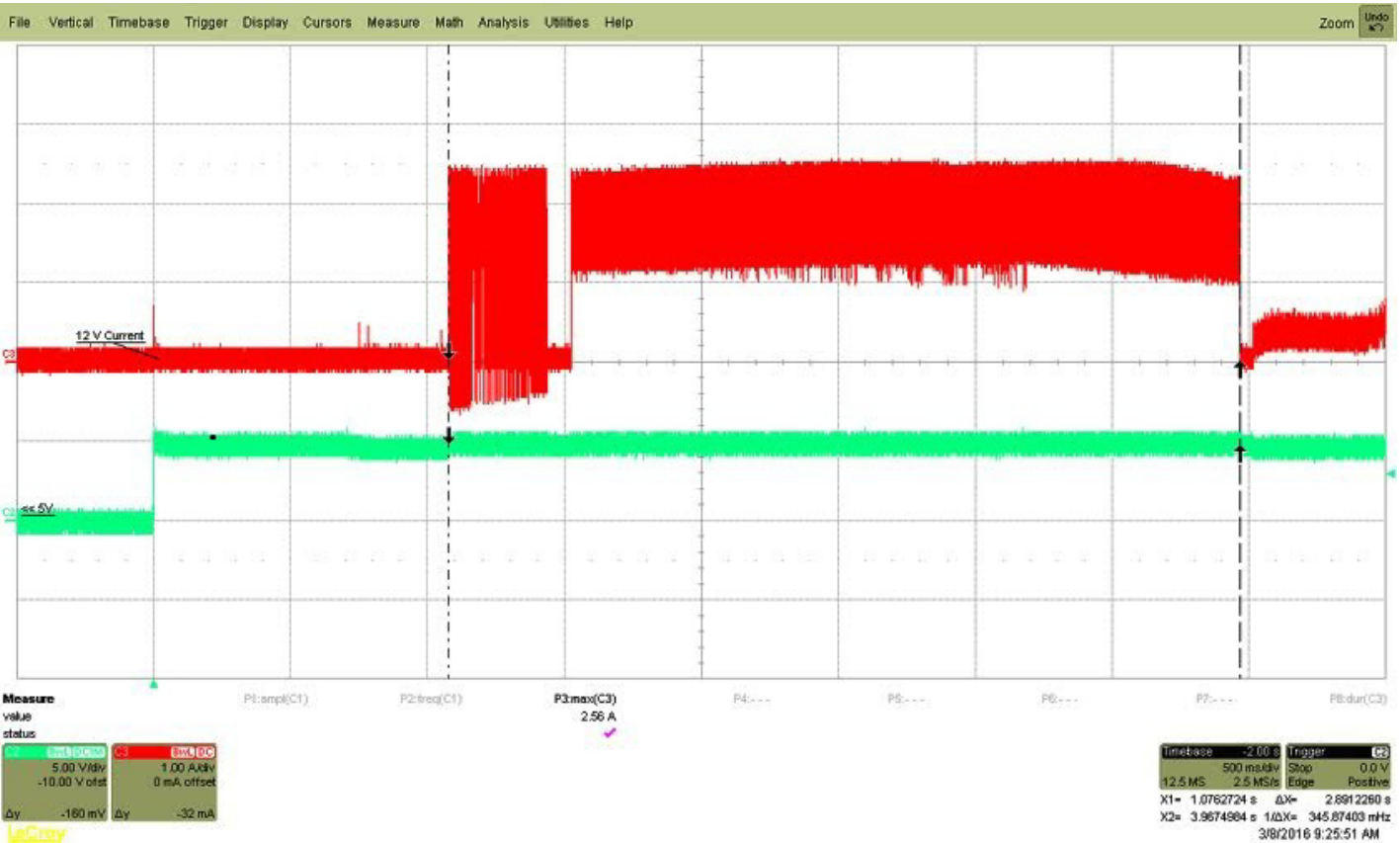

Figure 2. 2TB Typical 5V and 12V startup and operation current profile

### 2.5.2 Conducted noise

Input noise ripple is measured at the host system power supply across an equivalent 80-ohm resistive load on the +12 V line or an equivalent 15-ohm resistive load on the +5V line.

- Using 12V power, the drive is expected to operate with a maximum of 120mV peak-to-peak square-wave injected noise at up to 10MHz.
- Using 5V power, the drive is expected to operate with a maximum of 100mV peak-to-peak square-wave injected noise at up to 10MHz.

<b>Note</b>	Equivalent resistance is calculated by dividing the nominal voltage by the typical RMS read/write current.
-------------	------------------------------------------------------------------------------------------------------------

### 2.5.3 Voltage tolerance

Voltage tolerance (including noise):

5V +10/ -5%                      12V ± 10%

### 2.5.4 Extended Power Conditions - PowerChoice™

Utilizing the load/unload architecture a programmable power management interface is provided to tailor systems for reduced power consumption and performance requirements.

The table below lists the supported power conditions available in PowerChoice. Power conditions are ordered from highest power consumption (and shortest recovery time) to lowest power consumption (and longest recovery time) as follows: Idle\_a power >= Idle\_b power >= Idle\_c power >= Standby\_z power. The further users go down in the table, the more power savings is actualized. For example, Idle\_b results in greater power savings than the Idle\_a power condition. Standby results in the greatest power savings.

Power Condition Name	Power Condition ID	Description
Idle_a	81 <sub>H</sub>	Reduced electronics
Idle_b	82 <sub>H</sub>	Heads unloaded. Disks spinning at full RPM
Idle_c	83 <sub>H</sub>	Heads unloaded. Disks spinning at reduced RPM
Standby_z	00 <sub>H</sub>	Heads unloaded. Motor stopped (disks not spinning)

Each power condition has a set of current, saved and default settings. Default settings are not modifiable. Default and saved settings persist across power-on resets. The current settings do not persist across power-on resets. At the time of manufacture, the default, saved and current settings are in the Power Conditions log match.

#### PowerChoice is invoked using one of two methods

- Automatic power transitions which are triggered by expiration of individual power condition timers. These timer values may be customized and enabled using the Extended Power Conditions (EPC) feature set using the standardized Set Features command interface.
- Immediate host commanded power transitions may be initiated using an EPC Set Features "Go to Power Condition" subcommand to enter any supported power condition. Legacy power commands Standby Immediate and Idle Immediate also provide a method to directly transition the drive into supported power conditions.

#### PowerChoice exits power saving states under the following conditions

- Any command which requires the drive to enter the PM0: Active state (media access)
- Power on reset

#### PowerChoice provides the following reporting methods for tracking purposes

Check Power Mode Command

- Reports the current power state of the drive

Identify Device Command

- EPC Feature set supported flag
- EPC Feature enabled flag is set if at least one Idle power condition timer is enabled

Power Condition Log reports the following for each power condition

- Nominal recovery time from the power condition to active
- If the power condition is Supported, Changeable, and Savable
- Default enabled state, and timer value
- Saved enabled state, and timer value
- Current enabled state, and timer value

S.M.A.R.T. Read Data Reports

- Attribute 192 - Emergency Retract Count
- Attribute 193 - Load/Unload Cycle Count

### PowerChoice Manufacture Default Power Condition Timer Values

Default power condition timer values have been established to assure product reliability and data integrity. A minimum timer value threshold of two minutes ensures the appropriate amount of background drive maintenance activities occur. Attempting to set a timer values less than the specified minimum timer value threshold will result in an aborted EPC "Set Power Condition Timer" subcommand.

Power Condition Name	Manufacturer Default Timer Values
Idle_a	1 sec
Idle_b	2 min
Idle_c	4 min
Standby_z	15 min

Setting power condition timer values less than the manufacturer specified defaults or issuing the EPC "Go to Power Condition" subcommand at a rate exceeding the default timers may limit this products reliability and data integrity.

### PowerChoice Supported Extended Power Condition Feature Subcommands

EPC Subcommand	Description
00 <sub>H</sub>	Restore Power Condition Settings
01 <sub>H</sub>	Go to Power Condition
02 <sub>H</sub>	Set Power Condition Timer
03 <sub>H</sub>	Set Power Condition State
04 <sub>H</sub>	Enable EPC Feature Set
05 <sub>H</sub>	Disable EPC Feature Set

### PowerChoice Supported Extended Power Condition Identifiers

Power Condition Identifiers	Power Condition Name
00 <sub>H</sub>	Standby_z
01 - 80 <sub>H</sub>	Reserved
81 <sub>H</sub>	Idle_a
82 <sub>H</sub>	Idle_b
83 <sub>H</sub>	Idle_c
84 - FE <sub>H</sub>	Reserved
FF <sub>H</sub>	All EPC Power Conditions

## 2.6 Environmental limits

Temperature and humidity values experienced by the drive must be such that condensation does not occur on any drive part. Altitude and atmospheric pressure specifications are referenced to a standard day at 58.7°F (14.8°C).

**Note** To maintain optimal performance drives should be run at nominal drive temperatures and humidity.

### 2.6.1 Temperature

#### a. Operating

41°F to 140°F (5°C to 60°C) drive case temperature range with a maximum temperature gradient of 36°F (20°C) per hour.

The maximum allowable drive case temperature is 140°F (60°C).

Air flow may be required to achieve consistent nominal case temperature values (see Section 3.4). To confirm that the required cooling is provided for the electronics and HDA, place the drive in its final mechanical configuration, and perform random write/read operations. After the temperatures stabilize, measure the case temperature of the drive. See Figure 3 for HDA temperature checkpoint.

#### b. Non-operating

–40° to 158°F (–40° to 70°C) package ambient with a maximum gradient of 36°F (20°C) per hour. This specification assumes that the drive is packaged in the shipping container designed by Seagate for use with drive.

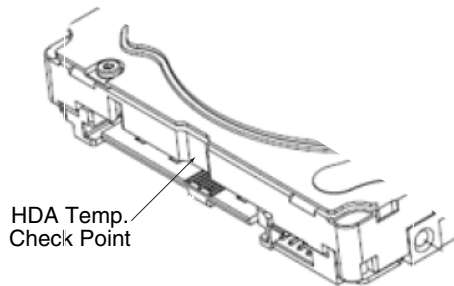

**Figure 3.** Location of the HDA temperature check point

**Note** Image is for reference only, may not represent actual drive

### 2.6.2 Humidity

The values below assume that no condensation on the drive occurs. Maximum wet bulb temperature is 84.2°F (29°C).

#### 2.6.2.1 Relative humidity

Operating:	5% to 95% non-condensing relative humidity with a maximum gradient of 20% per hour.
Nonoperating:	5% to 95% non-condensing relative humidity with a maximum gradient of 20% per hour.

### 2.6.3 Effective Altitude (sea level)

Operating:	–304.8 m to 3048 m (–1000 ft. to 10,000+ ft.)
Nonoperating:	–304.8 m to 12,192 m (–1000 ft. to 40,000+ ft.)

## 2.6.4 Shock

All shock specifications assume that the drive is mounted securely with the input shock applied at the drive mounting screws. Shock may be applied in the X, Y or Z axis.

### 2.6.4.1 Operating shock

These drives comply with the performance levels specified in this document when subjected to a maximum operating shock of 70 Gs (read) and 40 Gs (write) based on half-sine shock pulses of 2ms. Shocks should not be repeated more than two times per second.

### 2.6.4.2 Nonoperating shock

#### 4-1TB models

The nonoperating shock level that the drive can experience without incurring physical damage or degradation in performance when subsequently put into operation is 300 Gs based on a nonrepetitive half-sine shock pulse of 2ms duration.

## 2.6.5 Vibration

All vibration specifications assume that the drive is mounted securely with the input vibration applied at the drive mounting screws. Vibration may be applied in the X, Y or Z axis.

### 2.6.5.1 Operating vibration

The maximum vibration levels that the drive may experience while meeting the performance standards specified in this document are specified below.

5–22 Hz	0.25 Gs
22–350 Hz	0.50 Gs
350–500 Hz	0.25 Gs
20 - 1500Hz *(RROV)	12.5 rads/s <sup>2</sup> w/RVFF

\* Rotary Random Operating Vibration

### 2.6.5.2 Nonoperating vibration

The maximum nonoperating vibration levels that the drive may experience without incurring physical damage or degradation in performance when subsequently put into operation are specified below.

10–500 Hz Linear Random	4.9 Grms ref
----------------------------	--------------



## 2.7 Acoustics

Drive acoustics are measured as overall A-weighted acoustic sound power levels (no pure tones). All measurements are consistent with ISO document 7779. Sound power measurements are taken under essentially free-field conditions over a reflecting plane. For all tests, the drive is oriented with the cover facing upward.

<b>Note</b>	For seek mode tests, the drive is placed in seek mode only. The number of seeks per second is defined by the following equation: (Number of seeks per second = 0.4 / (average latency + average access time)
-------------	-----------------------------------------------------------------------------------------------------------------------------------------------------------------------------------------------------------------

**Table 4 Fluid Dynamic Bearing (FDB) motor acoustics**

	Idle*	Performance seek
All models	2.8 bels (typ) 3.0 bels (max)	3.2 bels (typ) 3.4 bels (max)

\*During periods of drive idle, some offline activity may occur according to the S.M.A.R.T. specification, which may increase acoustic and power to operational levels.

## 2.8 Test for Prominent Discrete Tones (PDTs)

Seagate follows the ECMA-74 standards for measurement and identification of PDTs. An exception to this process is the use of the absolute threshold of hearing. Seagate uses this threshold curve (originated in ISO 389-7) to discern tone audibility and to compensate for the inaudible components of sound prior to computation of tone ratios according to Annex D of the ECMA-74 standards.

## 2.9 Electromagnetic immunity

When properly installed in a representative host system, the drive operates without errors or degradation in performance when subjected to the radio frequency (RF) environments defined in the following table:

**Table 5 Radio frequency environments**

Test	Description	Performance level	Reference standard
Electrostatic discharge	Contact, HCP, VCP: ± 4 kV; Air: ± 8 kV	B	EN 61000-4-2: 95
Radiated RF immunity	80 to 1000 MHz, 3 V/m, 80% AM with 1 kHz sine 900 MHz, 3 V/m, 50% pulse modulation @ 200 Hz	A	EN 61000-4-3: 96 ENV 50204: 95
Electrical fast transient	± 1 kV on AC mains, ± 0.5 kV on external I/O	B	EN 61000-4-4: 95
Surge immunity	± 1 kV differential, ± 2 kV common, AC mains	B	EN 61000-4-5: 95
Conducted RF immunity	150 kHz to 80 MHz, 3 Vrms, 80% AM with 1 kHz sine	A	EN 61000-4-6: 97
Voltage dips, interrupts	0% open, 5 seconds 0% short, 5 seconds 40%, 0.10 seconds 70%, 0.01 seconds	C C C B	EN 61000-4-11: 94

## 2.10 Reliability

### 2.10.1 Annualized Failure Rate (AFR) and Mean Time Between Failures (MTBF)

The production disk drive shall achieve an annualized failure-rate of 0.44% (MTBF of 2,000,000 hours) over a 5 year service life when used in Enterprise Storage field conditions as limited by the following:

- 8760 power-on hours per year.
- HDA temperature as reported by the drive  $\leq 40^{\circ}\text{C}$
- Ambient wet bulb temp  $\leq 26^{\circ}\text{C}$
- Typical workload
- The AFR (MTBF) is a population statistic not relevant to individual units
- ANSI/ISA S71.04-2013 G2 classification levels and dust contamination to ISO 14644-1 Class 8 standards (as measured at the device)

The MTBF specification for the drive assumes the operating environment is designed to maintain nominal drive temperature and humidity. Occasional excursions in operating conditions between the rated MTBF conditions and the maximum drive operating conditions may occur without significant impact to the rated MTBF. However continual or sustained operation beyond the rated MTBF conditions will degrade the drive MTBF and reduce product reliability.

Nonrecoverable read errors	1 per $10^{15}$ bits read, max
Load unload cycles	600,000 cycles
Maximum Rated Workload	Maximum rate of $<550\text{TB}/\text{year}$ Workloads exceeding the annualized rate may degrade the drive MTBF and impact product reliability. The Annualized Workload Rate is in units of TB per year, or TB per 8760 power on hours. Workload Rate = TB transferred * (8760 / recorded power on hours).
Warranty	To determine the warranty for a specific drive, use a web browser to access the following web page: <a href="http://www.seagate.com/support/warranty-and-replacements/">http://www.seagate.com/support/warranty-and-replacements/</a> . From this page, click on the "Is my Drive under Warranty" link. The following are required to be provided: the drive serial number, model number (or part number) and country of purchase. The system will display the warranty information for the drive.
Preventive maintenance	None required.

## 2.11 Agency certification

### 2.11.1 Safety certification

These products are certified to meet the requirements of UL60950-1, CSA60950-1 and EN60950 and so marked as to the certify agency.

### 2.11.2 Electromagnetic compatibility

Hard drives that display the CE mark comply with the European Union (EU) requirements specified in the Electromagnetic Compatibility Directive (2004/108/EC) as put into place 20 July 2007. Testing is performed to the levels specified by the product standards for Information Technology Equipment (ITE). Emission levels are defined by EN 55022, Class B and the immunity levels are defined by EN 55024.

Drives are tested in representative end-user systems. Although CE-marked Seagate drives comply with the directives when used in the test systems, we cannot guarantee that all systems will comply with the directives. The drive is designed for operation inside a properly designed enclosure, with properly shielded I/O cable (if necessary) and terminators on all unused I/O ports. Computer manufacturers and system integrators should confirm EMC compliance and provide CE marking for their products.

## **Korean RRL**

If these drives have the Korean Communications Commission (KCC) logo, they comply with paragraph 1 of Article 11 of the Electromagnetic Compatibility control Regulation and meet the Electromagnetic Compatibility (EMC) Framework requirements of the Radio Research Laboratory (RRL) Communications Commission, Republic of Korea.

These drives have been tested and comply with the Electromagnetic Interference/Electromagnetic Susceptibility (EMI/EMS) for Class B products. Drives are tested in a representative, end-user system by a Korean-recognized lab.

## **Canada ICES-003**

If this model has the ICES-003 Marking it complies with the Canadian Standard Association Standard CAN/CSA-CISPR 22-10, Information Technology Equipment - Radio Disturbance Characteristics - Limits and Methods of Measurement.

## **Australian RCM Compliance Mark**

Models displayed with the RCM compliance mark, comply with the mandatory standards as per the Australian Communications and Media Authority (AMCA) Electromagnetic Compatibility (EMC) regulatory arrangement.

### **2.11.3 FCC verification**

These drives are intended to be contained solely within a personal computer or similar enclosure (not attached as an external device). As such, each drive is considered to be a subassembly even when it is individually marketed to the customer. As a subassembly, no Federal Communications Commission verification or certification of the device is required.

Seagate has tested this device in enclosures as described above to ensure that the total assembly (enclosure, disk drive, motherboard, power supply, etc.) does comply with the limits for a Class B computing device, pursuant to Subpart J, Part 15 of the FCC rules. Operation with noncertified assemblies is likely to result in interference to radio and television reception.

**Radio and television interference.** This equipment generates and uses radio frequency energy and if not installed and used in strict accordance with the manufacturer's instructions, may cause interference to radio and television reception.

This equipment is designed to provide reasonable protection against such interference in a residential installation. However, there is no guarantee that interference will not occur in a particular installation. If this equipment does cause interference to radio or television, which can be determined by turning the equipment on and off, users are encouraged to try one or more of the following corrective measures:

- Reorient the receiving antenna.
- Move the device to one side or the other of the radio or TV.
- Move the device farther away from the radio or TV.
- Plug the computer into a different outlet so that the receiver and computer are on different branch outlets.

If necessary, users should consult the dealer or an experienced radio/television technician for additional suggestions. Users may find helpful the following booklet prepared by the Federal Communications Commission: *How to Identify and Resolve Radio-Television Interference Problems*. This booklet is available from the Superintendent of Documents, U.S. Government Printing Office, Washington, DC 20402. Refer to publication number 004-000-00345-4.

## 2.12 Environmental protection

Seagate designs its products to meet environmental protection requirements worldwide, including regulations restricting certain chemical substances.

### 2.12.1 European Union Restriction of Hazardous Substances (RoHS) Directive

The European Union Restriction of Hazardous Substances (RoHS) Directive, restricts the presence of chemical substances, including Lead, Cadmium, Mercury, Hexavalent Chromium, PBB and PBDE, in electronic products, effective July 2006. This drive is manufactured with components and materials that comply with the RoHS Directive.

### 2.12.2 China Restriction of Hazardous Substances (RoHS) Directive 中国限制危险物品的指令

This product has an Environmental Protection Use Period (EPUP) of 20 years. The following table contains information mandated by China's "Marking Requirements for Control of Pollution Caused by Electronic Information Products" Standard.



该产品具有20年的环境保护使用周期（EPUP）。下表包含了中国“电子产品所导致的污染的控制的记号要求”所指定的信息。

Name of Parts 部件名称	Toxic or Hazardous Substances or Elements有毒有害物质或元素					
	Lead 铅 (Pb)	Mercury 汞 (Hg)	Cadmium 镉 (Cd)	Hexavalent Chromium 六价铬 (Cr6+)	Polybrominated Biphenyl 多溴联苯 (PBB)	Polybrominated Diphenyl Ether 多溴二苯醚 (PBDE)
PCBA	X	O	O	O	O	O
HDA	X	O	O	O	O	O

"O" indicates the hazardous and toxic substance content of the part (at the homogeneous material level) is lower than the threshold defined by the China RoHS MCV Standard.

“O”表示该部件（于同类物品程度上）所含的危险和有毒物质低于中国RoHS MCV标准所定义的门槛值。

"X" indicates the hazardous and toxic substance content of the part (at the homogeneous material level) is over the threshold defined by the China RoHS MCV Standard.

“X”表示该部件（于同类物品程度上）所含的危险和有毒物质超出中国RoHS MCV标准所定义的门槛值。

## 2.13 Corrosive environment

Seagate electronic drive components pass accelerated corrosion testing equivalent to 10 years exposure to light industrial environments containing sulfurous gases, chlorine and nitric oxide, classes G and H per ASTM B845. However, this accelerated testing cannot duplicate every potential application environment.

Users should use caution exposing any electronic components to uncontrolled chemical pollutants and corrosive chemicals as electronic drive component reliability can be affected by the installation environment. The silver, copper, nickel and gold films used in hard disk drives are especially sensitive to the presence of sulfide, chloride, and nitrate contaminants. Sulfur is found to be the most damaging. Materials used in cabinet fabrication, such as vulcanized rubber, that can outgas corrosive compounds should be minimized or eliminated. The useful life of any electronic equipment may be extended by replacing materials near circuitry with sulfide-free alternatives.

Seagate recommends that data centers be kept clean by monitoring and controlling the dust and gaseous contamination. Gaseous contamination should be within ANSI/ISA 571.04-2013 G2 classification levels (as measured on copper and silver coupons), and dust contamination to ISO 14644-1 Class 8 standards, and MTBF rated conditions as defined in the Annualized Failure Rate (AFR) and Mean Time Between Failure (MTBF) section.

## 2.14 Reference documents

Trusted Computing Group (TCG) Documents (apply to Self-Encrypting Drive models only)

TCG Storage Architecture Core Specification, v1.00 r1.0

TCG Storage Security Subsystem Class Enterprise Specification, v1.01 r1.00

In case of conflict between this document and any referenced document, this document takes precedence.

## 2.15 Product warranty

Beginning on the date of shipment to the customer and continuing for the period specified in the purchase contract, Seagate warrants that each product (including components and subassemblies) that fails to function properly under normal use due to defect in materials or workmanship or due to nonconformance to the applicable specifications will be repaired or replaced, at Seagate's option and at no charge to the customer, if returned by customer at customer's expense to Seagate's designated facility in accordance with Seagate's warranty procedure. Seagate will pay for transporting the repair or replacement item to the customer. For more detailed warranty information, refer to the standard terms and conditions of purchase for Seagate products on the purchase documentation.

The remaining warranty for a particular drive can be determined by calling Seagate Customer Service at 1-800-468-3472. Users can also determine remaining warranty using the Seagate web site ([www.seagate.com](http://www.seagate.com)). The drive serial number is required to determine remaining warranty information.

### Shipping

When transporting or shipping a drive, use only a Seagate-approved container. Keep the original box. Seagate approved containers are easily identified by the Seagate Approved Package label. Shipping a drive in a non-approved container voids the drive warranty.

Seagate repair centers may refuse receipt of components improperly packaged or obviously damaged in transit. Contact the authorized Seagate distributor to purchase additional boxes. Seagate recommends shipping by an air-ride carrier experienced in handling computer equipment.

### Storage

Maximum storage periods are 180 days within original unopened Seagate shipping package or 60 days unpackaged within the defined non-operating limits (refer to environmental section in this manual). Storage can be extended to 1 year packaged or unpackaged under optimal environmental conditions (25°C, <40% relative humidity non-condensing, and non-corrosive environment). During any storage period the drive non-operational temperature, humidity, wet bulb, atmospheric conditions, shock, vibration, magnetic and electrical field specifications should be followed.

### Product repair and return information

Seagate customer service centers are the only facilities authorized to service Seagate drives. Seagate does not sanction any third-party repair facilities. Any unauthorized repair or tampering with the factory seal voids the warranty.

## 3.0 Configuring and mounting the drive

This section contains the specifications and instructions for configuring and mounting the drive.

### 3.1 Handling and static-discharge precautions

After unpacking, and before installation, the drive may be exposed to potential handling and electrostatic discharge (ESD) hazards. Observe the following standard handling and static-discharge precautions:

<b>Caution</b>	<ul style="list-style-type: none"><li>• Before handling the drive, put on a grounded wrist strap, or ground oneself frequently by touching the metal chassis of a computer that is plugged into a grounded outlet. Wear a grounded wrist strap throughout the entire installation procedure.</li><li>• Handle the drive by its edges or frame <i>only</i>.</li><li>• The drive is extremely fragile—handle it with care. Do not press down on the drive top cover.</li><li>• Always rest the drive on a padded, antistatic surface until mounting it in the computer.</li><li>• Do not touch the connector pins or the printed circuit board.</li><li>• Do not remove the factory-installed labels from the drive or cover them with additional labels. Removal voids the warranty. Some factory-installed labels contain information needed to service the drive. Other labels are used to seal out dirt and contamination.</li></ul>
----------------	----------------------------------------------------------------------------------------------------------------------------------------------------------------------------------------------------------------------------------------------------------------------------------------------------------------------------------------------------------------------------------------------------------------------------------------------------------------------------------------------------------------------------------------------------------------------------------------------------------------------------------------------------------------------------------------------------------------------------------------------------------------------------------------------------------------------------------------------------------------------------------------------------------------------------------------

### 3.2 Configuring the drive

Each drive on the Serial ATA interface connects point-to-point with the Serial ATA host adapter. There is no master/slave relationship because each drive is considered a master in a point-to-point relationship. If two drives are attached on one Serial ATA host adapter, the host operating system views the two devices as if they were both “masters” on two separate ports. Both drives behave as if they are Device 0 (master) devices.

### 3.3 Serial ATA cables and connectors

The Serial ATA interface cable consists of four conductors in two differential pairs, plus three ground connections. The cable size may be 30 to 26 AWG with a maximum length of one meter (39.37 in). See Table 6 for connector pin definitions. Either end of the SATA signal cable can be attached to the drive or host.

For direct backplane connection, the drive connectors are inserted directly into the host receptacle. The drive and the host receptacle incorporate features that enable the direct connection to be hot pluggable and blind mateable.

For installations which require cables, users can connect the drive as illustrated in Figure 4.

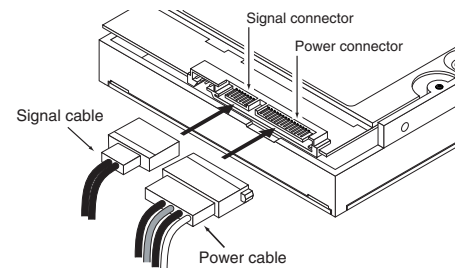

**Figure 4. Attaching SATA cabling**

Each cable is keyed to ensure correct orientation. Enterprise Capacity 3.5 HDD Serial ATA drives support latching SATA connectors.

### 3.4 Drive mounting

Users can mount the drive in any orientation using four screws in the side-mounting holes or four screws in the bottom-mounting holes. See Figure 6 for drive mounting dimensions. Follow these important mounting precautions when mounting the drive:

- Allow a minimum clearance of 0.030 in (0.76mm) around the entire perimeter of the drive for cooling.
- Use only 6-32 UNC mounting screws.
- The screws should be inserted no more than 0.140 in (3.56mm) into the bottom or side mounting holes.
- Do not overtighten the mounting screws (maximum torque: 6 in-lb).
- Do not cover breather hole on top cover.

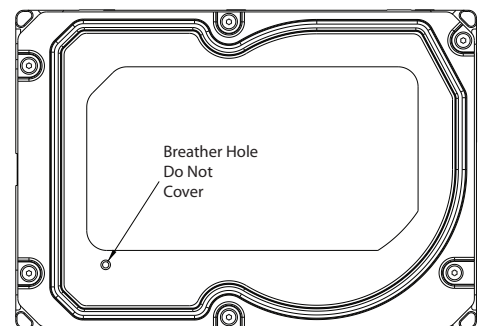

**Figure 5. Breather hole location - top cover**

### 3.4.1 Mechanical specifications

Refer to Figure 6 for detailed mounting configuration dimensions. See Section 3.4, "Drive mounting."

Weight:	4TB & 3TB models	1.55 lb	704 g
	2TB & 1TB models	1.34 lb	610 g

**Note** These dimensions conform to the Small Form Factor Standard documented in SFF-8301 and SFF-8323, found at [www.sffcommittee.org](http://www.sffcommittee.org)

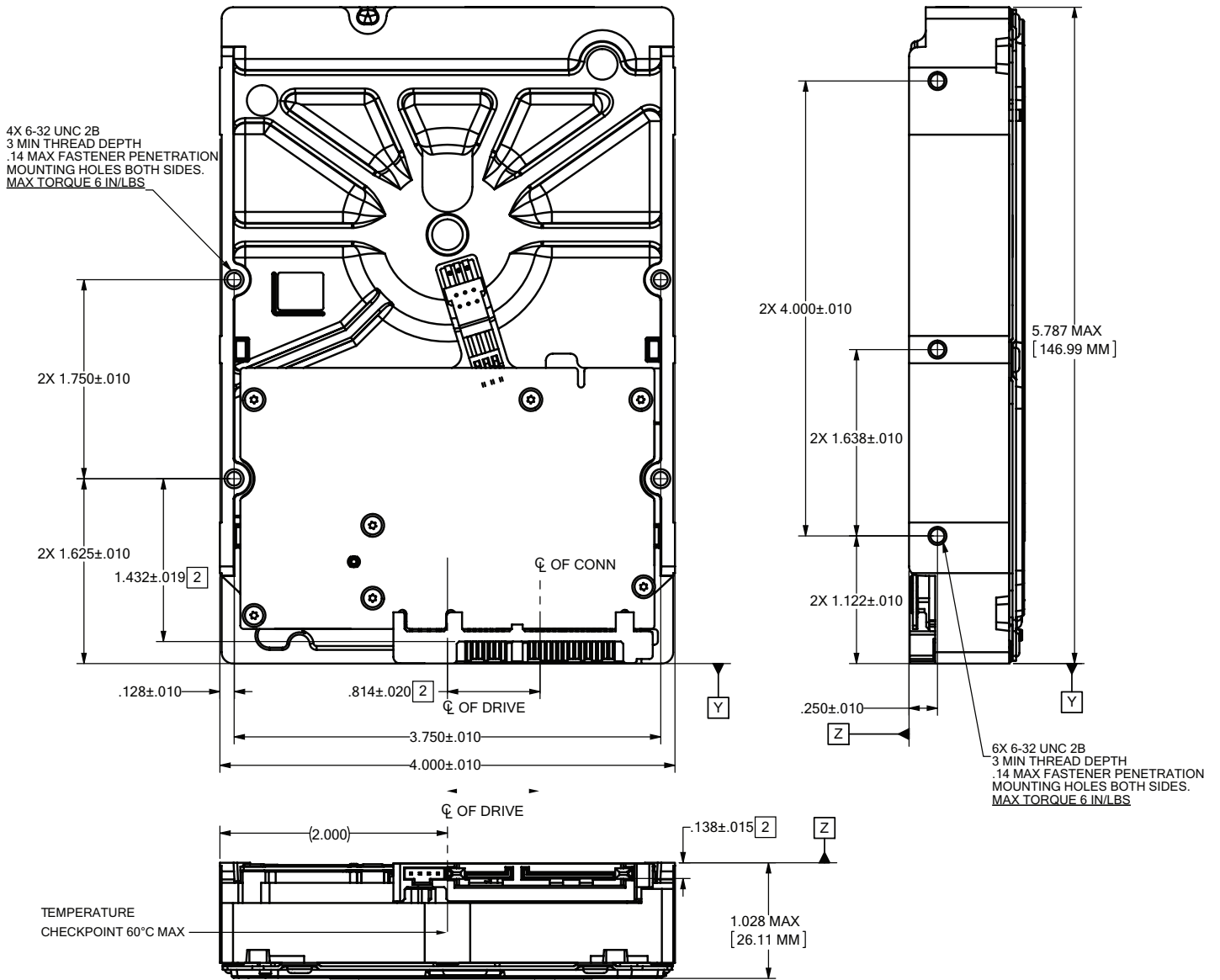

**Figure 6. Mounting configuration dimensions (4TB - 1TB)**

**Note** The image is for mechanical dimension reference only and may not represent the actual drive.

## 4.0 About self-encrypting drives

Self-encrypting drives (SEDs) offer encryption and security services for the protection of stored data, commonly known as "protection of data at rest." These drives are compliant with the Trusted Computing Group (TCG) Enterprise Storage Specifications as detailed in Section 2.14.

The Trusted Computing Group (TCG) is an organization sponsored and operated by companies in the computer, storage and digital communications industry. Seagate's SED models comply with the standards published by the TCG.

To use the security features in the drive, the host must be capable of constructing and issuing the following two ATA commands:

- Trusted Send
- Trusted Receive

These commands are used to convey the TCG protocol to and from the drive in their command payloads.

### 4.1 Data encryption

Encrypting drives use one inline encryption engine for each port, employing AES-256 bit data encryption in AES-XTS mode to encrypt all data prior to being written on the media and to decrypt all data as it is read from the media. The encryption engines are always in operation and cannot be disabled.

The 32-byte Data Encryption Key (DEK) is a random number which is generated by the drive, never leaves the drive, and is inaccessible to the host system. The DEK is itself encrypted when it is stored on the media and when it is in volatile temporary storage (DRAM) external to the encryption engine. A unique data encryption key is used for each of the drive's possible 16 data bands (see Section 7.5).

### 4.2 Controlled access

The drive has two security providers (SPs) called the "Admin SP" and the "Locking SP." These act as gatekeepers to the drive security services. Security-related commands will not be accepted unless they also supply the correct credentials to prove the requester is authorized to perform the command.

#### 4.2.1 Admin SP

The Admin SP allows the drive's owner to enable or disable firmware download operations (see Section 4.4). Access to the Admin SP is available using the SID (Secure ID) password or the MSID (Manufacturers Secure ID) password.

#### 4.2.2 Locking SP

The Locking SP controls read/write access to the media and the cryptographic erase feature. Access to the Locking SP is available using the BandMasterX or EraseMaster passwords. Since the drive owner can define up to 16 data bands on the drive, each data band has its own password called BandMasterX where X is the number of the data band (0 through 15).

#### 4.2.3 Default password

When the drive is shipped from the factory, all passwords are set to the value of MSID. This 32-byte random value can only be read by the host electronically over the interface. After receipt of the drive, it is the responsibility of the owner to use the default MSID password as the authority to change all other passwords to unique owner-specified values.



### 4.3 Random number generator (RNG)

The drive has a 32-byte hardware RNG that it uses to derive encryption keys or, if requested to do so, to provide random numbers to the host for system use, including using these numbers as Authentication Keys (passwords) for the drive's Admin and Locking SPs.

### 4.4 Drive locking

In addition to changing the passwords, as described in Section 4.2.3, the owner should also set the data access controls for the individual bands.

The variable "LockOnReset" should be set to "PowerCycle" to ensure that the data bands will be locked if power is lost. In addition "ReadLockEnabled" and "WriteLockEnabled" must be set to true in the locking table in order for the bands "LockOnReset" setting of "PowerCycle" to actually lock access to the band when a "PowerCycle" event occurs. This scenario occurs if the drive is removed from its cabinet. The drive will not honor any data read or write requests until the bands have been unlocked. This prevents the user data from being accessed without the appropriate credentials when the drive has been removed from its cabinet and installed in another system.

When the drive is shipped from the factory, the firmware download port is unlocked.

### 4.5 Data bands

When shipped from the factory, the drive is configured with a single data band called Band 0 (also known as the Global Data Band) which comprises LBA 0 through LBA max. The host may allocate Band1 by specifying a start LBA and an LBA range. The real estate for this band is taken from the Global Band. An additional 30 Data Bands may be defined in a similar way (Band2 through Band31) but before these bands can be allocated LBA space, they must first be individually enabled using the EraseMaster password.

Data bands cannot overlap but they can be sequential with one band ending at LBA (x) and the next beginning at LBA (x+1).

Each data band has its own drive-generated encryption key and its own user-supplied password. The host may change the Encryption Key (see Section 4.6) or the password when required. The bands should be aligned to 4K LBA boundaries.

### 4.6 Cryptographic erase

A significant feature of SEDs is the ability to perform a cryptographic erase. This involves the host telling the drive to change the data encryption key for a particular band. Once changed, the data is no longer recoverable since it was written with one key and will be read using a different key. Since the drive overwrites the old key with the new one, and keeps no history of key changes, the user data can never be recovered. This is tantamount to an instantaneous data erase and is very useful if the drive is to be scrapped or redispositioned.

### 4.7 Authenticated firmware download

In addition to providing a locking mechanism to prevent unwanted firmware download attempts, the drive also only accepts download files which have been cryptographically signed by the appropriate Seagate Design Center.

Three conditions must be met before the drive will allow the download operation:

1. The download must be an SED file. A standard (base) drive (non-SED) file will be rejected.
2. The download file must be signed and authenticated.
3. As with a non-SED drive, the download file must pass the acceptance criteria for the drive. For example it must be applicable to the correct drive model, and have compatible revision and customer status.

## 4.8 Power requirements

The standard drive models and the SED drive models have identical hardware, however the security and encryption portion of the drive controller ASIC is enabled and functional in the SED models. This represents a small additional drain on the 5V supply of about 30mA and a commensurate increase of about 150mW in power consumption. There is no additional drain on the 12V supply. See the tables in Section 2.5 for power requirements on the standard (non-SED) drive models.

## 4.9 Supported commands

The SED models support the following two commands in addition to the commands supported by the standard (non-SED) models as listed in Table 7:

- Trusted Send (5Eh) or Trusted Send DMA (5Fh)
- Trusted Receive (5Ch) or Trusted Receive DMA (5D)

## 4.10 RevertSP

SED models will support the RevertSP feature which erases all data in all bands on the device and returns the contents of all SPs (Security Providers) on the device to their original factory state. In order to execute the RevertSP method the unique PSID (Physical Secure ID) printed on the drive label must be provided. PSID is not electronically accessible and can only be manually read from the drive label or scanned in via the 2D barcode.

## 4.11 ATA Security Erase Unit Command on SED SATA drives

The ATA SECURITY ERASE UNIT command shall support both the Normal and Enhanced erase modes with the following modifications/additions:

- Normal Erase: Normal erase shall be accomplished by changing the media encryption key for the drive followed by an overwrite operation that repeatedly writes a single sector containing random data to the entire drive. The write operation shall bypass the media encryption. On reading back the overwritten sectors, the host will receive a decrypted version, using the new encryption key, of the random data sector (the returned data will not match what was written).
- Enhanced Erase: Enhanced erase shall be accomplished by changing the media encryption key for the drive.

## 4.12 Sanitize Device - CRYPTO SCRAMBLE EXT

This command cryptographically erases all user data on the drive by destroying the current data encryption key and replacing it with a new data encryption key randomly generated by the drive. Sanitize Device is a command field B4h and Feature field 0011h (CRYPTO SCRAMBLE EXT).

The drive shall support the Sanitize Feature Set as defined in ANSI/INCITS ACS-2 with the exceptions and/or modifications described in this section.

The drive shall not support the OVERWRITE EXT and BLOCK ERASE EXT sub-commands.

Support of the SANITIZE FREEZE LOCK EXT command shall be determined on a customer-specific basis. OEM drives shall support the command.

## 5.0 About FIPS

The Federal Information Processing Standard (FIPS) Publication 140-2 is a U.S. Government Computer Security Standard used to accredit cryptographic modules. It is titled 'Security Requirements for Cryptographic Modules (FIPS PUB 140-2)' and is issued by the National Institute of Standards and Technology (NIST).

### Purpose

This standard specifies the security requirements that will be satisfied by a cryptographic module utilized within a security system protecting sensitive but unclassified information. The standard provides four increasing, qualitative levels of security: Level 1, Level 2, Level 3 and Level 4. These levels are intended to cover the wide range of potential applications and environments in which cryptographic modules may be employed.

### Seagate Enterprise SEDs

The SEDs referenced in this Product Manual have been validated by CMVP and have been thoroughly tested by a NVLAP accredited lab to satisfy FIPS 140-2 Level 2 requirements. In order to operate in FIPS Approved Mode of Operation, these SEDs require security initialization. For more information, refer to 'Security Rules' section in the 'Security Policy' document uploaded on the NIST website. To reference the product certification visit - <http://csrc.nist.gov/groups/STM/cmvp/documents/140-1/1401vend.htm> and search for "Seagate".

### Level 2 security

Security Level 2 enhances the physical security mechanisms of a Security Level 1 cryptographic module by adding the requirement for tamper-evidence, which includes the use of tamper-evident coatings or seals on removable covers of the module. Tamper-evident coatings or seals are placed on a cryptographic module so that the coating or seal must be broken to attain physical access to the critical security parameters (CSP) within the module. Tamper-evident seals are placed on covers to protect against unauthorized physical access. In addition Security Level 2 requires, at a minimum, role-based authentication in which a cryptographic module authenticates the authorization of an operator to assume a specific role and perform a corresponding set of services.

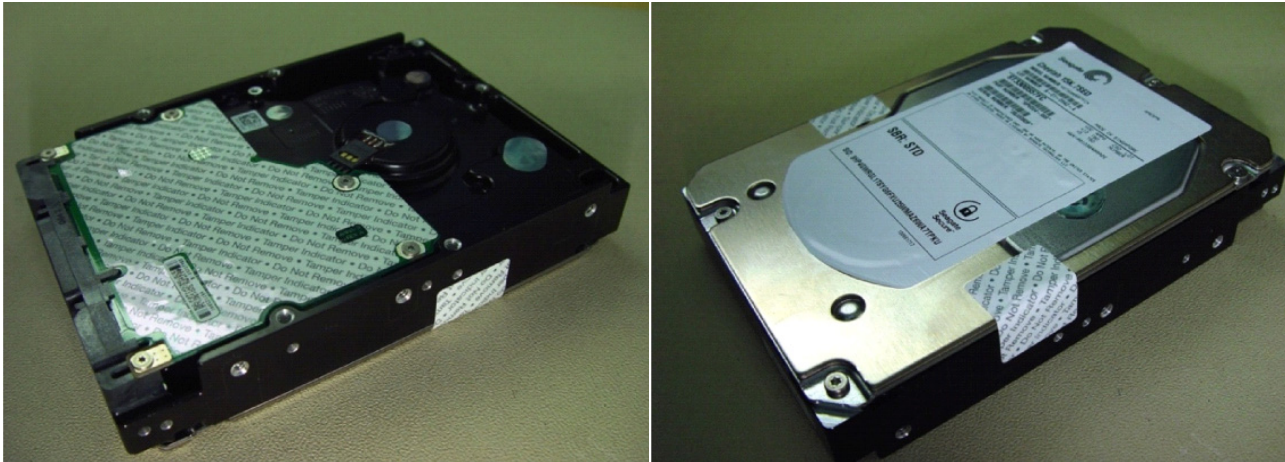

Figure 7. Example of FIPS tamper evidence labels.

**Note** Image is for reference only, may not represent actual drive

## 6.0 Serial ATA (SATA) interface

These drives use the industry-standard Serial ATA interface that supports FIS data transfers. It supports ATA programmed input/output (PIO) modes 0–4; multiword DMA modes 0–2, and Ultra DMA modes 0–6.

For detailed information about the Serial ATA interface, refer to the “Serial ATA: High Speed Serialized AT Attachment” specification.

### 6.1 Hot-Plug compatibility

Enterprise Capacity 3.5 HDD Serial ATA drives incorporate connectors which enable users to hot plug these drives in accordance with the Serial ATA Revision 3.2 specification. This specification can be downloaded from [www.serialata.org](http://www.serialata.org).

<b>Caution</b>	The drive motor must come to a complete stop ( <b>Ready to spindle stop time indicated in Section 2.4</b> ) prior to changing the plane of operation. This time is required to insure data integrity.
----------------	-------------------------------------------------------------------------------------------------------------------------------------------------------------------------------------------------------

### 6.2 Serial ATA device plug connector pin definitions

Table 6 summarizes the signals on the Serial ATA interface and power connectors.

**Table 6 Serial ATA connector pin definitions**

Segment	Pin	Function	Definition
<b>Signal</b>	S1	Ground	2nd mate
	S2	A+	Differential signal pair A from Phy
	S3	A-	
	S4	Ground	2nd mate
	S5	B-	Differential signal pair B from Phy
	S6	B+	
	S7	Ground	2nd mate
<b>Key and spacing separate signal and power segments</b>			
<b>Power</b>	P1	V <sub>33</sub>	3.3V power
	P2	V <sub>33</sub>	3.3V power
	P3	V <sub>33</sub>	3.3V power, pre-charge, 2nd mate
	P4	Ground	1st mate
	P5	Ground	2nd mate
	P6	Ground	2nd mate
	P7	V <sub>5</sub>	5V power, pre-charge, 2nd mate
	P8	V <sub>5</sub>	5V power
	P9	V <sub>5</sub>	5V power
	P10	Ground	2nd mate
	P11	Ground or LED signal	If grounded, drive does not use deferred spin
	P12	Ground	1st mate.
	P13	V <sub>12</sub>	12V power, pre-charge, 2nd mate
	P14	V <sub>12</sub>	12V power
	P15	V <sub>12</sub>	12V power

**Notes:**

- All pins are in a single row, with a 1.27mm (0.050”) pitch.
- The comments on the mating sequence apply to the case of backplane blindmate connector only. In this case, the mating sequences are:
  - the ground pins P4 and P12.
  - the pre-charge power pins and the other ground pins.
  - the signal pins and the rest of the power pins.
- There are three power pins for each voltage. One pin from each voltage is used for pre-charge when installed in a blind-mate backplane configuration.
- All used voltage pins (V<sub>x</sub>) must be terminated.

### 6.3 Supported ATA commands

The following table lists Serial ATA standard commands that the drive supports. For a detailed description of the ATA commands, refer to the Serial ATA: High Speed Serialized AT Attachment specification. See “S.M.A.R.T. commands” on page 34 for details and subcommands used in the S.M.A.R.T. implementation.

**Table 7 Supported ATA commands**

Command name	Command code (in hex)
Accessible Max Address Configuration	
Get Native Max Address Ext	78 <sub>H</sub> / 0000 <sub>H</sub>
Set Accessible Max Address Ext	78 <sub>H</sub> / 0001 <sub>H</sub>
Freeze Accessible Max Address Ext	78 <sub>H</sub> / 0002 <sub>H</sub>
Check Power Mode	E5 <sub>H</sub>
Download Microcode	92 <sub>H</sub>
Execute Device Diagnostics	90 <sub>H</sub>
Flush Cache	E7 <sub>H</sub>
Flush Cache Extended	EA <sub>H</sub>
Identify Device	EC <sub>H</sub>
Idle	E3 <sub>H</sub>
Idle Immediate	E1 <sub>H</sub>
NoP	00 <sub>H</sub>
Read Buffer	E4 <sub>H</sub>
Read Buffer DMA	E9 <sub>H</sub>
Read DMA	C8 <sub>H</sub>
Read DMA Extended	25 <sub>H</sub>
Read FPDMA Queued	60 <sub>H</sub>
Read Log DMA Ext	47 <sub>H</sub>
Read Log Ext	2F <sub>H</sub>
Read Multiple	C4 <sub>H</sub>
Read Multiple Extended	29 <sub>H</sub>
Read Sectors	20 <sub>H</sub>
Read Sectors Extended	24 <sub>H</sub>
Read Sectors Without Retries	21 <sub>H</sub>
Read Verify Sectors	40 <sub>H</sub>
Read Verify Sectors Extended	42 <sub>H</sub>
Read Verify Sectors Without Retries	41 <sub>H</sub>
Request Sense Data Ext	0B <sub>H</sub>
Sanitize Device - Overwrite Ext	B4 <sub>H</sub> / 0014 <sub>H</sub>
Sanitize Device - Freeze Lock Ext	B4 <sub>H</sub> / 0020 <sub>H</sub>
Sanitize Device - Status Ext	B4 <sub>H</sub> / 0000 <sub>H</sub>
Security Disable Password	F6 <sub>H</sub>
Security Erase Prepare	F3 <sub>H</sub>
Security Erase Unit	F4 <sub>H</sub>
Security Freeze	F5 <sub>H</sub>
Security Set Password	F1 <sub>H</sub>
Security Unlock	F2 <sub>H</sub>

<b>Command name</b>	<b>Command code (in hex)</b>
Seek	70 <sub>H</sub>
Set Date & Time Ext	77 <sub>H</sub>
Set Features	EF <sub>H</sub>
Set Multiple Mode	C6 <sub>H</sub>
Sleep	E6 <sub>H</sub>
S.M.A.R.T. Disable Operations	B0 <sub>H</sub> / D9 <sub>H</sub>
S.M.A.R.T. Enable/Disable Autosave	B0 <sub>H</sub> / D2 <sub>H</sub>
S.M.A.R.T. Enable Operations	B0 <sub>H</sub> / D8 <sub>H</sub>
S.M.A.R.T. Execute Offline	B0 <sub>H</sub> / D4 <sub>H</sub>
S.M.A.R.T. Read Attribute Thresholds	B0 <sub>H</sub> / D1 <sub>H</sub>
S.M.A.R.T. Read Data	B0 <sub>H</sub> / D0 <sub>H</sub>
S.M.A.R.T. Read Log Sector	B0 <sub>H</sub> / D5 <sub>H</sub>
S.M.A.R.T. Return Status	B0 <sub>H</sub> / DA <sub>H</sub>
S.M.A.R.T. Save Attribute Values	B0 <sub>H</sub> / D3 <sub>H</sub>
S.M.A.R.T. Write Log Sector	B0 <sub>H</sub> / D6 <sub>H</sub>
Standby	E2 <sub>H</sub>
Standby Immediate	E0 <sub>H</sub>
Trusted Send	5E <sub>H</sub> (SED drives only)
Trusted Send DMA	5F <sub>H</sub> (SED drives only)
Trusted Receive	5C <sub>H</sub> (SED drives only)
Trusted Receive DMA	5D <sub>H</sub> (SED drives only)
Write Buffer	E8 <sub>H</sub>
Write Buffer DMA	EB <sub>H</sub>
Write DMA	CA <sub>H</sub>
Write DMA Extended	35 <sub>H</sub>
Write DMA FUA Extended	3D <sub>H</sub>
Write FPDMA Queued	61 <sub>H</sub>
Write Log DMA Ext	57 <sub>H</sub>
Write Log Extended	3F <sub>H</sub>
Write Multiple	C5 <sub>H</sub>
Write Multiple Extended	39 <sub>H</sub>
Write Multiple FUA Extended	CE <sub>H</sub>
Write Sectors	30 <sub>H</sub>
Write Sectors Without Retries	31 <sub>H</sub>
Write Sectors Extended	34 <sub>H</sub>
Write Uncorrectable	45 <sub>H</sub>

### 6.3.1 Identify Device command

The Identify Device command (command code EC<sub>H</sub>) transfers information about the drive to the host following power up. The data is organized as a single 512-byte block of data, whose contents are shown in Table 7 on page 28. All reserved bits or words should be set to zero. Parameters listed with an “x” are drive-specific or vary with the state of the drive. See Section 2.0 on page 6 for default parameter settings.

The following commands contain drive-specific features that may not be included in the Serial ATA specification.

Word	Description	Value
0	Configuration information: • Bit 15: 0 = ATA; 1 = ATAPI • Bit 7: removable media • Bit 6: removable controller • Bit 0: reserved	0C5A <sub>H</sub>
1	Number of logical cylinders	16,383
2	ATA-reserved	0000 <sub>H</sub>
3	Number of logical heads	16
4	Retired	0000 <sub>H</sub>
5	Retired	0000 <sub>H</sub>
6	Number of logical sectors per logical track: 63	003F <sub>H</sub>
7–9	Retired	0000 <sub>H</sub>
10–19	Serial number: (20 ASCII characters, 0000 <sub>H</sub> = none)	ASCII
20	Retired	0000 <sub>H</sub>
21	Retired	0400 <sub>H</sub>
22	Obsolete	0000 <sub>H</sub>
23–26	Firmware revision (8 ASCII character string, padded with blanks to end of string)	xxxx
27–46	Drive model number: (40 ASCII characters, padded with blanks to end of string)	
47	(Bits 7–0) Maximum sectors per interrupt on Read multiple and Write multiple (16)	8010 <sub>H</sub>
48	Trusted computing feature set options	4000 <sub>H</sub>
49	Standard Standby timer, IORDY supported and may be disabled	2F00 <sub>H</sub>
50	ATA-reserved	0000 <sub>H</sub>
51	PIO data-transfer cycle timing mode	0200 <sub>H</sub>
52	Retired	0200 <sub>H</sub>
53	Words 54–58, 64–70 and 88 are valid	0007 <sub>H</sub>
54	Number of current logical cylinders	xxxx <sub>H</sub>
55	Number of current logical heads	xxxx <sub>H</sub>
56	Number of current logical sectors per logical track	xxxx <sub>H</sub>
57–58	Current capacity in sectors	xxxx <sub>H</sub>
59	Number of sectors transferred during a Read Multiple or Write Multiple command	xxxx <sub>H</sub>
60–61	Total number of user-addressable LBA sectors available (see Section 2.2 for related information) *Note: The maximum value allowed in this field is: 0FFFFFFFh (268,435,455 sectors, 137GB). Drives with capacities over 137GB will have 0FFFFFFFh in this field and the actual number of user-addressable LBAs specified in words 100-103. This is required for drives that support the 48-bit addressing feature.	0FFFFFFFh*
62	Retired	0000 <sub>H</sub>
63	Multiword DMA active and modes supported (see note following this table)	xx07 <sub>H</sub>

Word	Description	Value
64	Advanced PIO modes supported (modes 3 and 4 supported)	0003 <sub>H</sub>
65	Minimum multiword DMA transfer cycle time per word (120 ns)	0078 <sub>H</sub>
66	Recommended multiword DMA transfer cycle time per word (120 ns)	0078 <sub>H</sub>
67	Minimum PIO cycle time without IORDY flow control (240 ns)	0078 <sub>H</sub>
68	Minimum PIO cycle time with IORDY flow control (120 ns)	0078 <sub>H</sub>
69	Additional supported	00008 <sub>H</sub>
70–74	ATA-reserved	0000 <sub>H</sub>
75	Queue depth	001F <sub>H</sub>
76	Serial ATA capabilities	8D0E <sub>H</sub>
77	Reserved for future Serial ATA definition	xxxx <sub>H</sub>
78	Serial ATA features supported	xxxx <sub>H</sub>
79	Serial ATA features enabled	xxxx <sub>H</sub>
80	Major version number	07F0 <sub>H</sub>
81	Minor version number	006D <sub>H</sub>
82	Command sets supported	306B <sub>H</sub>
83	Command sets supported	7561 <sub>H</sub>
84	Command sets support extension (see note following this table)	6173 <sub>H</sub>
85	Command sets enabled	3069 <sub>H</sub>
86	Command sets enabled	B441 <sub>H</sub>
87	Command sets enable extension	6173 <sub>H</sub>
88	Ultra DMA support and current mode (see note following this table)	207F <sub>H</sub>
89	Security erase time	xxxx <sub>H</sub>
90	Enhanced security erase time	xxxx <sub>H</sub>
92	Master password revision code	FFFE <sub>H</sub>
93	Hardware reset value	xxxx <sub>H</sub>
95–99	ATA-reserved	0000 <sub>H</sub>
100–103	Total number of user-addressable LBA sectors available (see Section 2.2 for related information). These words are required for drives that support the 48-bit addressing feature. Maximum value: 0000FFFFFFFFFh.	4TB 5xx models = 7,814,037,168 3TB 5xx models = 5,860,533,168 2TB 5xx models = 3,907,029,168 1TB 5xx models = 1,953,525,168
104–105	ATA-reserved	0000 <sub>H</sub>
106	Physical/Logical sector size	6003 <sub>H</sub>
107	ATA-reserved	0000 <sub>H</sub>
108–111	The mandatory value of the world wide name (WWN) for the drive. NOTE: This field is valid if word 84, bit 8 is set to 1 indicating 64-bit WWN support.	Each drive will have a unique value.
112–118	ATA-reserved	0000 <sub>H</sub>
119	Commands and feature sets supported	410E <sub>H</sub>
120	Commands and feature sets supported or enabled	409C <sub>H</sub>
121–127	ATA-reserved	0000 <sub>H</sub>
128	Security status	0021 <sub>H</sub>
129–159	Seagate-reserved	xxxx <sub>H</sub>
160–205	ATA-reserved	0000 <sub>H</sub>



Word	Description	Value
206	SCT Command Transport command set. If bit 0 is set to one, then the device supports SCT Command Transport. Bits 7:2 indicate individual SCT feature support.	xxBD <sub>H</sub>
207-254	ATA-reserved	0000 <sub>H</sub>
255	Integrity word	xxA5 <sub>H</sub>

<b>Note</b>	See the bit descriptions below for words 63, 84, and 88 of the Identify Drive data.
-------------	-------------------------------------------------------------------------------------

Description (if bit is set to 1)		
	<b>Bit</b>	<b>Word 63</b>
	0	Multiword DMA mode 0 is supported.
	1	Multiword DMA mode 1 is supported.
	2	Multiword DMA mode 2 is supported.
	8	Multiword DMA mode 0 is currently active.
	9	Multiword DMA mode 1 is currently active.
	10	Multiword DMA mode 2 is currently active.
	<b>Bit</b>	<b>Word 84</b>
	0	SMART error logging is supported.
	1	SMART self-test is supported.
	2	Media serial number is supported.
	3	Media Card Pass Through Command feature set is supported.
	4	Streaming feature set is supported.
	5	GPL feature set is supported.
	6	WRITE DMA FUA EXT and WRITE MULTIPLE FUA EXT commands are supported.
	7	WRITE DMA QUEUED FUA EXT command is supported.
	8	64-bit World Wide Name is supported.
	9-10	Obsolete.
	11-12	Reserved for TLC.
	13	IDLE IMMEDIATE command with IUNLOAD feature is supported.
	14	Shall be set to 1.
	15	Shall be cleared to 0.
	<b>Bit</b>	<b>Word 88</b>
	0	Ultra DMA mode 0 is supported.
	1	Ultra DMA mode 1 is supported.
	2	Ultra DMA mode 2 is supported.
	3	Ultra DMA mode 3 is supported.
	4	Ultra DMA mode 4 is supported.
	5	Ultra DMA mode 5 is supported.
	6	Ultra DMA mode 6 is supported.
	8	Ultra DMA mode 0 is currently active.
	9	Ultra DMA mode 1 is currently active.
	10	Ultra DMA mode 2 is currently active.
	11	Ultra DMA mode 3 is currently active.
	12	Ultra DMA mode 4 is currently active.
	13	Ultra DMA mode 5 is currently active.
	14	Ultra DMA mode 6 is currently active.

### 6.3.2 Set Features command

This command controls the implementation of various features that the drive supports. When the drive receives this command, it sets BSY, checks the contents of the Features register, clears BSY and generates an interrupt. If the value in the register does not represent a feature that the drive supports, the command is aborted. Power-on default has the read look-ahead and write caching features enabled. The acceptable values for the Features register are defined as follows

**Table 8** Set Features command values

02 <sub>H</sub>	Enable write cache ( <i>default</i> ).
03 <sub>H</sub>	Set transfer mode (based on value in Sector Count register). Sector Count register values:
00 <sub>H</sub>	Set PIO mode to default (PIO mode 2).
01 <sub>H</sub>	Set PIO mode to default and disable IORDY (PIO mode 2).
08 <sub>H</sub>	PIO mode 0
09 <sub>H</sub>	PIO mode 1
0A <sub>H</sub>	PIO mode 2
0B <sub>H</sub>	PIO mode 3
0C <sub>H</sub>	PIO mode 4 ( <i>default</i> )
20 <sub>H</sub>	Multiword DMA mode 0
21 <sub>H</sub>	Multiword DMA mode 1
22 <sub>H</sub>	Multiword DMA mode 2
40 <sub>H</sub>	Ultra DMA mode 0
41 <sub>H</sub>	Ultra DMA mode 1
42 <sub>H</sub>	Ultra DMA mode 2
43 <sub>H</sub>	Ultra DMA mode 3
44 <sub>H</sub>	Ultra DMA mode 4
45 <sub>H</sub>	Ultra DMA mode 5
46 <sub>H</sub>	Ultra DMA mode 6
10 <sub>H</sub>	Enable use of SATA features
55 <sub>H</sub>	Disable read look-ahead (read cache) feature.
82 <sub>H</sub>	Disable write cache
90 <sub>H</sub>	Disable use of SATA features
AA <sub>H</sub>	Enable read look-ahead (read cache) feature ( <i>default</i> ).
F1 <sub>H</sub>	Report full capacity available

**Note** At power-on, or after a hardware or software reset, the default values of the features are as indicated above.

### 6.3.3 S.M.A.R.T. commands

S.M.A.R.T. provides near-term failure prediction for disk drives. When S.M.A.R.T. is enabled, the drive monitors predetermined drive attributes that are susceptible to degradation over time. If self-monitoring determines that a failure is likely, S.M.A.R.T. makes a status report available to the host. Not all failures are predictable. S.M.A.R.T. predictability is limited to the attributes the drive can monitor. For more information on S.M.A.R.T. commands and implementation, see the *Draft ATA-5 Standard*.

SeaTools diagnostic software activates a built-in drive self-test (DST S.M.A.R.T. command for D4<sub>H</sub>) that eliminates unnecessary drive returns. The diagnostic software ships with all new drives and is also available at: <http://www.seagate.com/support/downloads/seatools/>.

This drive is shipped with S.M.A.R.T. features disabled. Users must have a recent BIOS or software package that supports S.M.A.R.T. to enable this feature. The table below shows the S.M.A.R.T. command codes that the drive uses.

**Table 9 S.M.A.R.T. commands**

Code in features register	S.M.A.R.T. command
D0 <sub>H</sub>	S.M.A.R.T. Read Data
D2 <sub>H</sub>	S.M.A.R.T. Enable/Disable Attribute Autosave
D3 <sub>H</sub>	S.M.A.R.T. Save Attribute Values
D4 <sub>H</sub>	S.M.A.R.T. Execute Off-line Immediate (runs DST)
D5 <sub>H</sub>	S.M.A.R.T. Read Log Sector
D6 <sub>H</sub>	S.M.A.R.T. Write Log Sector
D8 <sub>H</sub>	S.M.A.R.T. Enable Operations
D9 <sub>H</sub>	S.M.A.R.T. Disable Operations
DA <sub>H</sub>	S.M.A.R.T. Return Status

<b>Note</b>	If an appropriate code is not written to the Features Register, the command is aborted and 0x04 (abort) is written to the Error register.
-------------	-------------------------------------------------------------------------------------------------------------------------------------------



**Seagate Technology LLC**

*AMERICAS Seagate Technology LLC 10200 South De Anza Boulevard, Cupertino, California 95014, United States, 408-658-1000*

*ASIA/PACIFIC Seagate Singapore International Headquarters Pte. Ltd. 7000 Ang Mo Kio Avenue 5, Singapore 569877, 65-6485-3888*

*EUROPE, MIDDLE EAST AND AFRICA Seagate Technology SAS 16-18 rue du Dôme, 92100 Boulogne-Billancourt, France, 33 1-4186 10 00*

*Publication Number: 100793636, Rev. A*

*March 2016*