

# **ST7MDT20J-EMU3 Probe User Guide**

Release 2.3

**March 2005**



Ref: DOC-ST7MDT20J-EMU3



### **INSTRUCTIONS FOR USE—WARNING**

This product is conform to the 89/336/EEC Directive. It complies with the ITE EN55022 standard for EMC emissions and generic 50082-1 (1992 edition) immunity standards.

**This product is an FCC Class-A apparatus. In a residential environment, it may cause radioelectrical disturbances.**

Please refer to [Appendix A: EMC Conformity and Safety Requirements](#) on page 21 for relevant safety information.

### **USE IN LIFE SUPPORT DEVICES OR SYSTEMS MUST BE EXPRESSLY AUTHORIZED.**

STMicroelectronics PRODUCTS ARE NOT AUTHORIZED FOR USE AS CRITICAL COMPONENTS IN LIFE SUPPORT DEVICES OR SYSTEMS WITHOUT THE EXPRESS WRITTEN APPROVAL OF STMicroelectronics. As used herein:

1. Life support devices or systems are those which (a) are intended for surgical implant into the body, or (b) support or sustain life, and whose failure to perform, when properly used in accordance with instructions for use provided with the product, can be reasonably expected to result in significant injury to the user.
2. A critical component is any component of a life support device or system whose failure to perform can reasonably be expected to cause the failure of the life support device or system, or to affect its safety or effectiveness.

---

# Table of Contents

---

<b>Chapter 1: Introduction</b>	<b>4</b>
1.1 About the user manuals	6
<b>Chapter 2: Delivery Checklist</b>	<b>7</b>
<b>Chapter 3: Installing the flex adapter in your ST7 EMU3 probe</b>	<b>9</b>
3.1 Connecting the flex adapter to the EMU3 probe	10
3.2 SDIP42 microcontroller package	12
3.3 TQFP44 (10 x 10) microcontroller package	13
3.4 SDIP32 microcontroller package	14
3.5 TQFP32 microcontroller package	15
<b>Chapter 4: Emulation characteristics</b>	<b>16</b>
4.1 On-chip peripherals configuration	16
4.2 Emulator electrical characteristics	19
4.3 Emulation functional limitations and discrepancies	20
<b>Appendix A: EMC Conformity and Safety Requirements</b>	<b>21</b>
<b>Appendix B: Changing the TEB in your ST7 EMU3 probe</b>	<b>22</b>
<b>Appendix C: Document Revision History</b>	<b>25</b>
<b>Product Support</b>	<b>26</b>
Software updates	26
Hardware spare parts	26
Getting prepared before you call	27
Contact List	28

## 1 INTRODUCTION

The **ST7-EMU3 series emulators** are the third generation of high-end emulators for ST7. EMU3 series emulators are designed to provide a complete range of advanced debugging features. In addition, they contain all the adapters, connectors and sockets you need to emulate any of the supported ST7 devices.

Your **EMU3 probe** is the component of the ST7-EMU3 emulator that contains target-emulating hardware. It connects to your PC via the **ST Micro Connect box**, and it can connect to your application board in place of your ST7.

The EMU3 probe's **Target Emulation Board (TEB)** contains the hardware that allows you to emulate a specific MCU or family of MCU's. This allows you to emulate a range of ST7 MCUs with one EMU3 emulator. For this reason, the ST7MDT20J Target Emulation Board is delivered either as part of the ST7MDT20J-EMU3 emulator kit, or independently, in the ST7MDT20J-TEB kit.

The ST7MDT20J-EMU3 emulator is designed to emulate MCUs in the **ST72321**, **ST72324** and **ST72344** families.

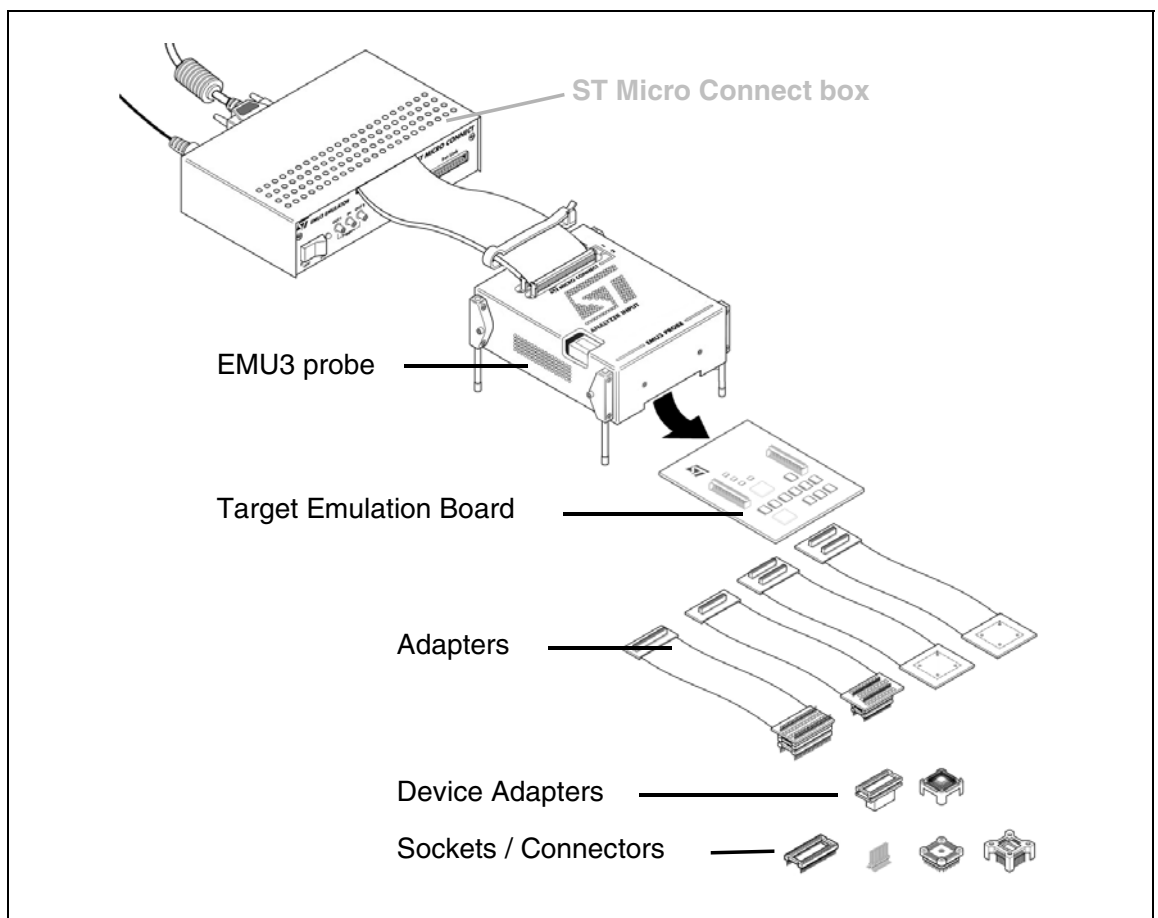

**Figure 1: ST7MDTxxx-EMU3 terminology**

The EMU3 probe connects to your application board via adapters, device adapters and socket or connectors, which are furnished as part of the emulator or TEB kit.

**Adapters** (also called flex adapters), connect to the probe's target emulation board. Depending on the package of the target device, they can be connected directly to a socket on your application board, or a device adapter.

**Device Adapters** are special adapters for certain MCUs, which allow the connection of a flex adapter to the socket on the application board.

A **Socket**, which matches your MCU's package, allows the connection of the probe's adapter/device adapter to your application board. Sockets have the added advantage of allowing you to install your ST7 without any modification of the application hardware once you have disconnected the probe from it.

## 1.1 About the user manuals

This manual will help you connect your ST7MDT20J-EMU3 emulator to your application board in place of your ST7 microcontroller. Information is provided to help you connect using the provided adapters and sockets. You will also find information about the emulation characteristics of your ST7MDT20J-EMU3 emulator.

For information about the software and additional hardware intended for use with your emulator, refer to the following documents that are included with it:

***ST7 Visual Develop User Manual*** - build and debug your application software

***ST7-EMU3 Emulator User Manual*** - set up instructions for your emulator

***ST72324B ST72F324 Datasheet*** or ***ST72321 Datasheet*** - includes debugging and programming information that is specific to these ST7 families.

Because of the modularity of the EMU3 emulator, this guide is delivered with the following products:

- ST7MDT20J-TEB
- ST7MDT20J-EMU3 emulator

## 2 DELIVERY CHECKLIST

The EMU3 probe is typically delivered as part of the **ST7MDT20J-EMU3 emulator kit**. This kit contains the emulator components (refer to the delivery check list in your *ST7-EMU3 Emulator User Manual*), as well as all of the probe accessories listed below.

Owners of other versions of EMU3 emulators can configure them to emulate the ST72324 and ST72321 families with the **ST7MDT20J-TEB kit**. This kit includes the ST7MDT20J TEB (ref.: DB518) to install in the probe, as well as the connection accessories listed below (No. 2-5).

The **ST7MDT20J-EMU3 Probe kit** includes (refer to [Figure 2](#)):

- 1 The ST7-EMU3 probe with slots for connections to the ST Micro Connect box, and analyzer input connector. The ST7MDT20J-EMU3-TEB target emulation board (ref.: DB518) already installed in the ST7 EMU3 probe.
- 2 A 21.5 cm flex adapter with SDIP42 connector (ref.: DB523), for connection between the EMU3 probe and the SDIP42 socket mounted on your application board.
- 3 A 19.5 cm flex adapter with SDIP32 connector (ref.: DB510), for connection between the EMU3 probe and the SDIP32 socket mounted on your application board.
- 4 Connection accessories for the TQFP44 package:
  - a A 22.5 cm flex adapter with TQFP44 connector (ref.: DB521), for connection between the EMU3 probe and the TQFP44 socket mounted on your application board.
  - b One Yamaichi TQFP44 socket and cover kit (with screws and washers), to solder to your application board.
- 5 Connection accessories for the TQFP32 package:
  - a A 19 cm flex adapter with TQFP32 connector (ref.: DB522) for connection between the EMU3 probe and the TQFP32 male connector mounted on your application board.
  - b A TQFP32 male connector to be soldered to your application board.

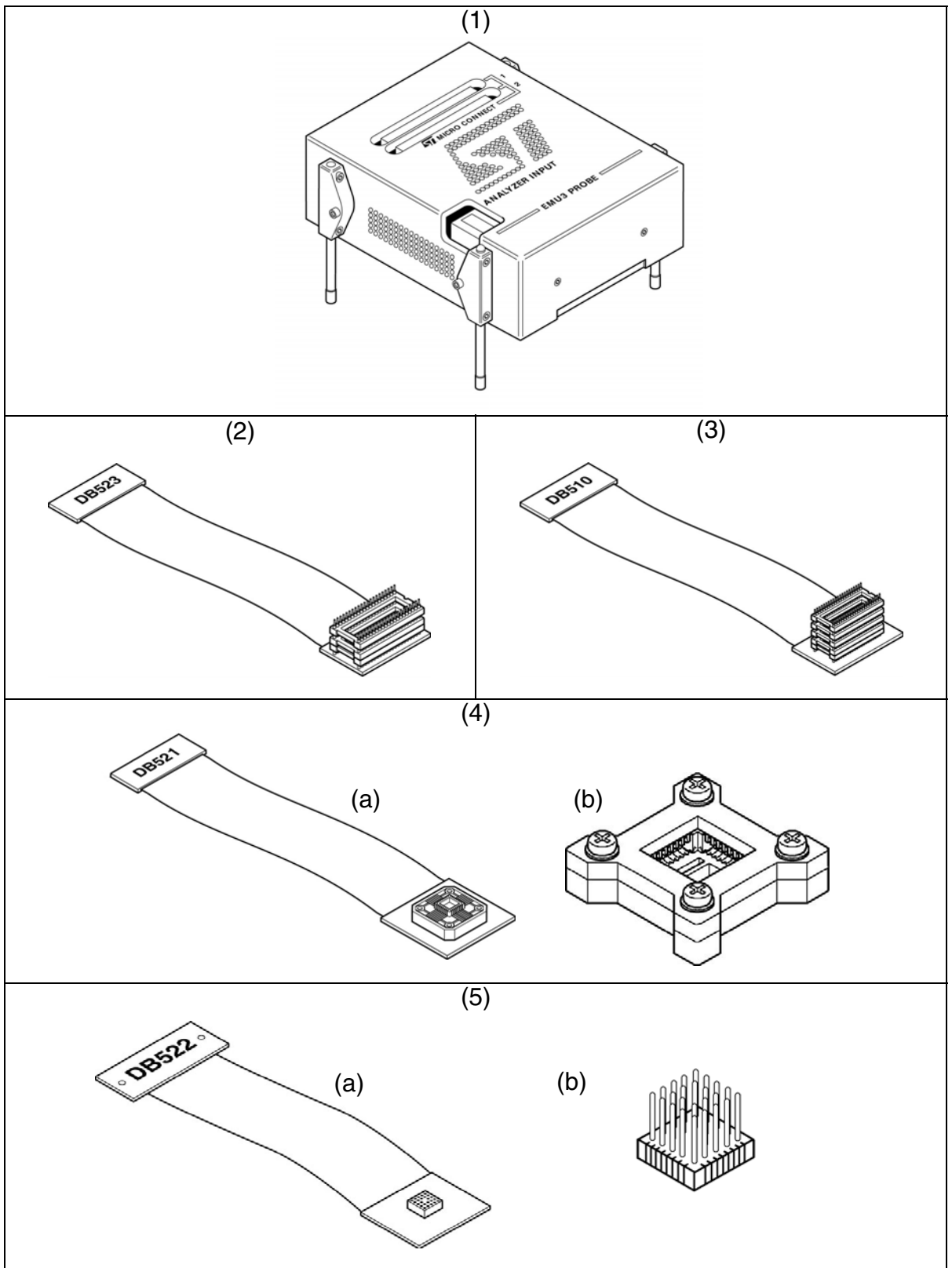

Figure 2: ST7MDT20J-EMU3 Probe kit



### 3 INSTALLING THE FLEX ADAPTER IN YOUR ST7 EMU3 PROBE

The following sections tell you how to:

- connect the flex adapter to the TEB, which is housed in the EMU3 probe,
- assemble the appropriate flex adapter and socket to emulate your target MCU,

The target MCUs that are emulated by the ST7MDT20J-EMU3 Probe exist in various microcontroller packages—four different packages in total. To connect the emulator to your application board, you must assemble/connect the flex adapter, adapters and/or sockets for the microcontroller package you are using.

*Table 1* summarizes the parts to assemble for each target MCU and package shows which flex adapter and TEB connector to use for each target MCU and package.

**Table 1: Flex adapters and TEB connectors for supported MCU packages**

Package	Flex adapter required	TEB connector (see <a href="#">Figure 4</a> )
SDIP42	SDIP42 flex adapter (ref.: DB523)	“SDIP42/TQFP44” connector
TQFP44 (10 x 10)	TQFP44 flex adapter (ref.:DB521)	
SDIP32	SDIP32 flex adapter (ref.:DB510)	“SDIP32” connector
TQFP32 (7 x 7)	TQFP32 flex adapter (ref.:DB522)	

### 3.1 Connecting the flex adapter to the EMU3 probe

- 1 Turn the EMU3 probe upside-down, unscrew the retaining screw and slide the bottom out as shown in [Figure 3](#).

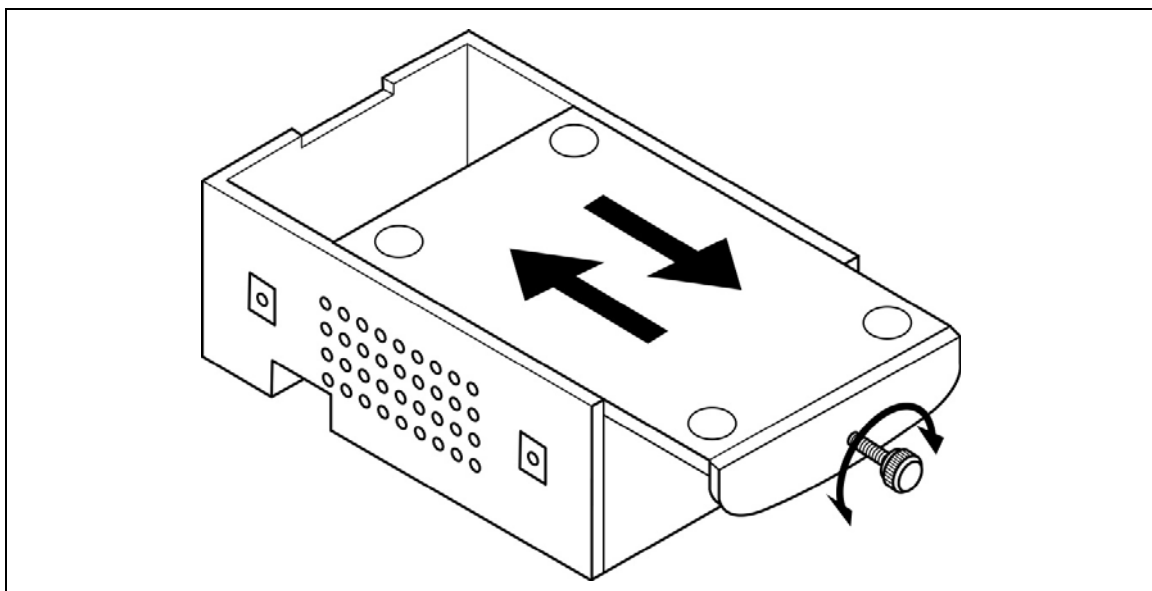

**Figure 3: Opening the bottom of the probe**

- 2 Using [Table 1](#), identify the TEB connectors you must use for your microcontroller's package. Connect the flex adapter supporting your microcontroller package to the appropriate connectors on the bottom face of the TEB. [Figure 4](#) shows a the SDIP32 flex adapter (ref.: DB510) being inserted into its SDIP32 connector.

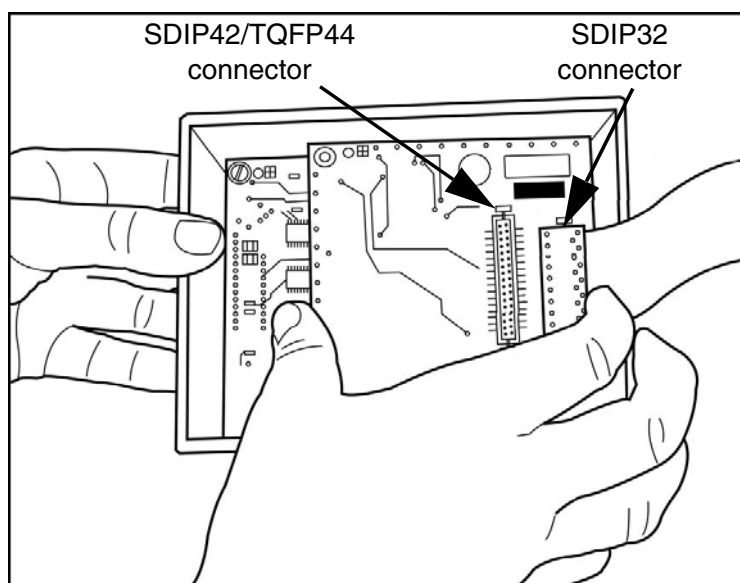

**Figure 4: Connecting flex adapter to TEB**

- 3 Replace the bottom panel of the probe housing so that the flex adapter feeds through the slot provided.
- 4 Reconnect the probe to the ST Micro Connect box by connecting the two 80-pin flat cables to the ST Micro Connect connection ports on the top face of the probe housing.
- 5 Continue by connecting your flex adapter to your application board. A procedure for each supported package is provided in the following sections:
  - [Section 3.2: SDIP42 microcontroller package](#) on page 12.
  - [Section 3.3: TQFP44 \(10 x 10\) microcontroller package](#) on page 13.
  - [Section 3.4: SDIP32 microcontroller package](#) on page 14.
  - [Section 3.5: TQFP32 microcontroller package](#) on page 15.

### 3.2 SDIP42 microcontroller package

- 1 Solder a SDIP42 socket onto your application board.
- 2 Align the pin 1 indicators on the SDIP42 connector of the DB513 flex adapter, then insert the into the socket on your application board as shown in [Figure 5](#).

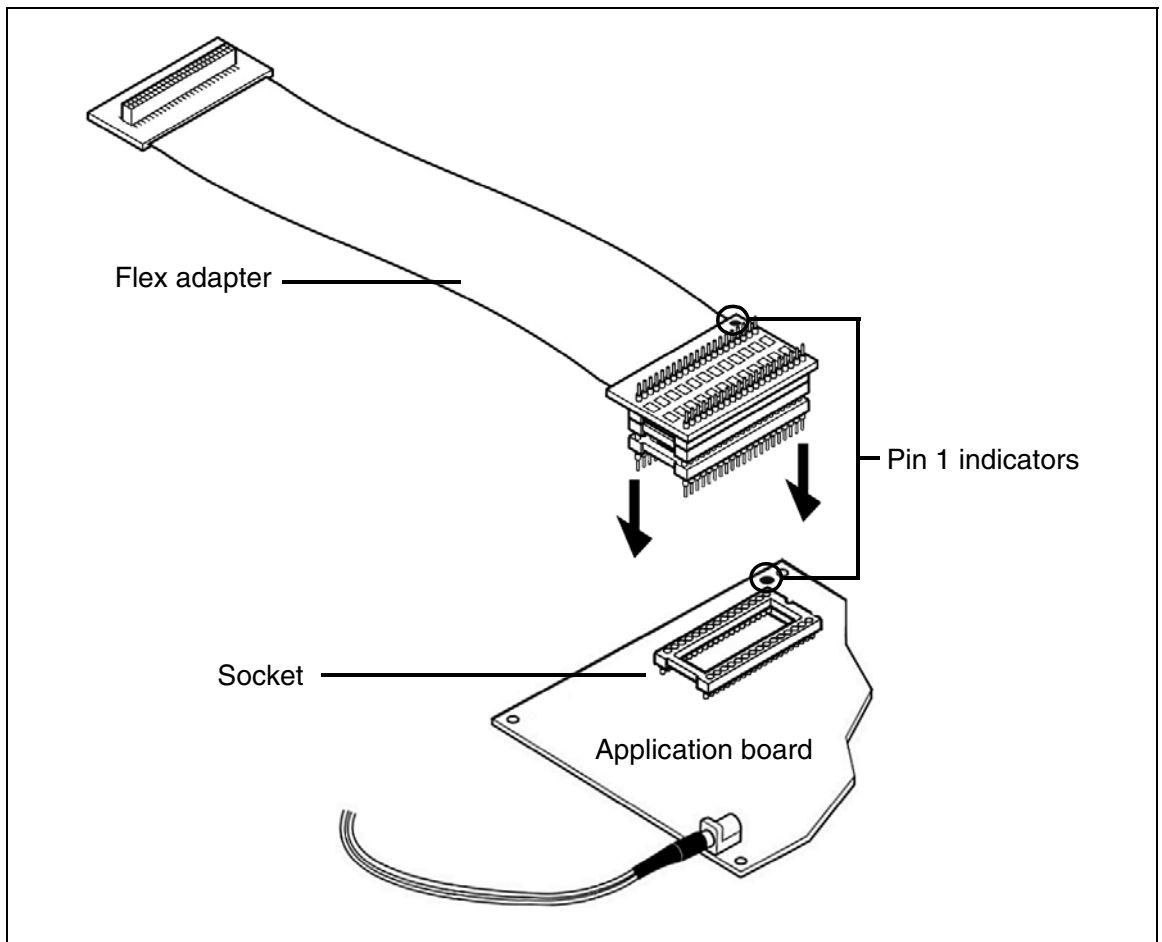

Figure 5: SDIP42 connection scheme

### 3.3 TQFP44 (10 x 10) microcontroller package

- 1 Solder the Yamaichi TQFP44 socket onto your application board, according to the manufacturer's instructions.

*Note:* Put aside the cover provided with the Yamaichi TQFP44 socket. You can use it later to fasten an actual microcontroller into the socket in place of the emulator's flex adapter.

- 2 Align the pin 1 indicators on the TQFP44 end of the DB521 flex adapter and the TQFP64 socket. Then insert the connector on the flex adapter into the socket on your application board as shown in [Figure 6](#), and fasten with the provided screws.

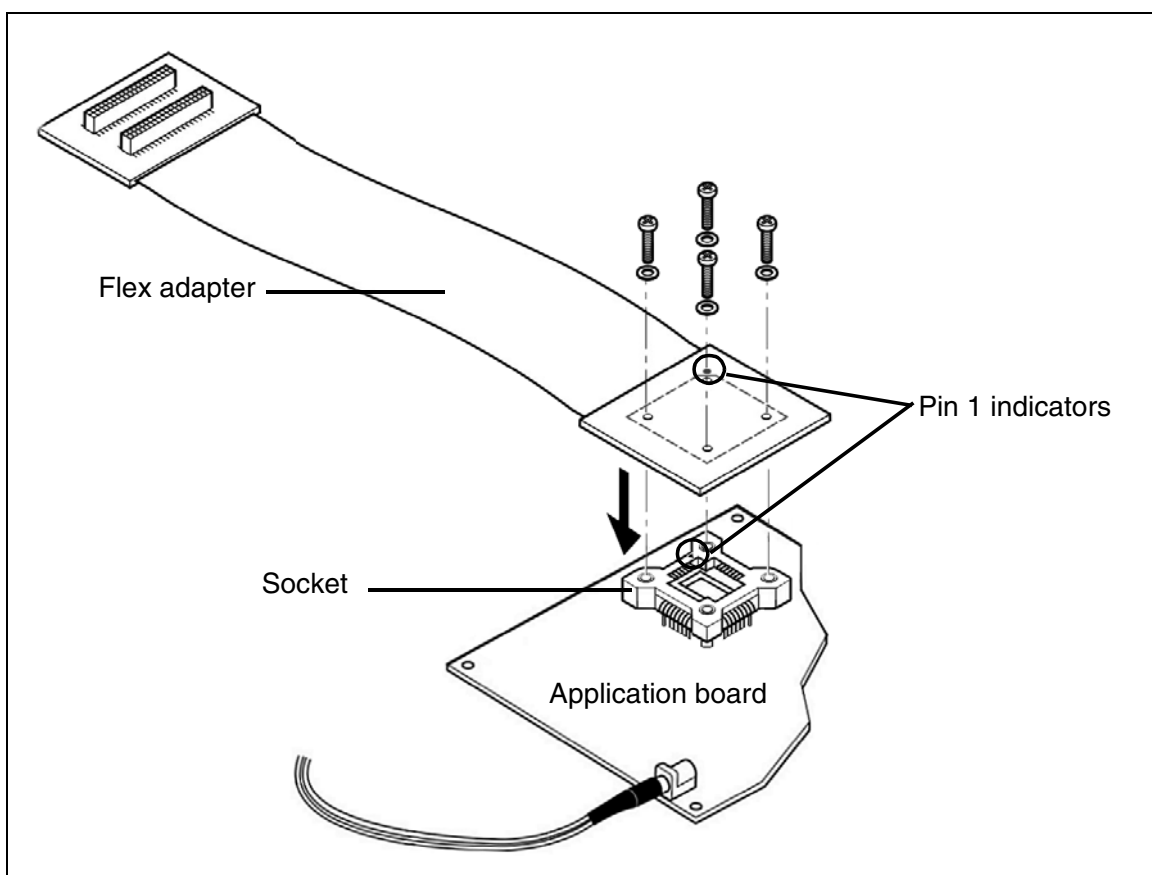

**Figure 6: TQFP44 (10 x 10) connection scheme**

### 3.4 SDIP32 microcontroller package

- 1 Solder a SDIP32 socket onto your application board.
- 2 Align the pin 1 indicators on the SDIP32 connector of the DB510 flex adapter, then insert the SDIP32 end of the DB510 flex adapter into the socket on your application board as shown in [Figure 7](#).

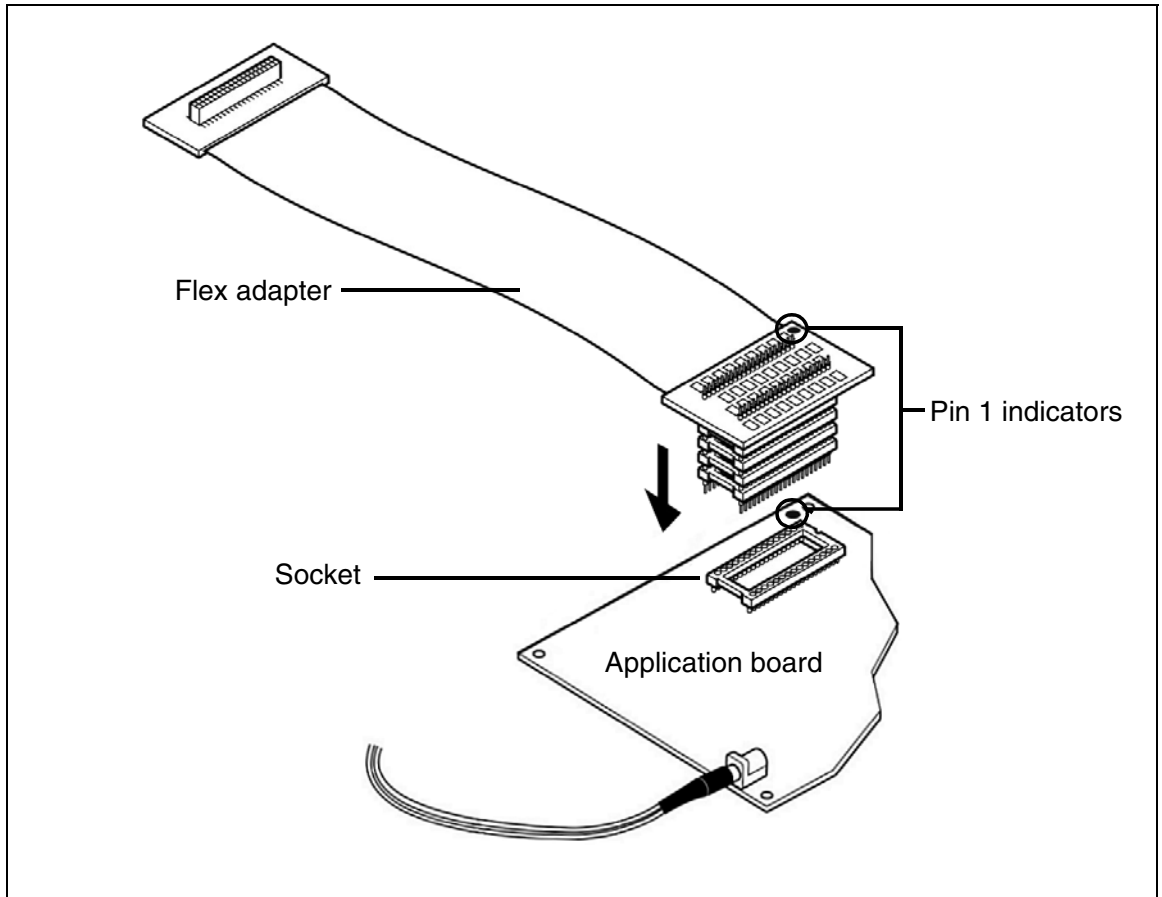
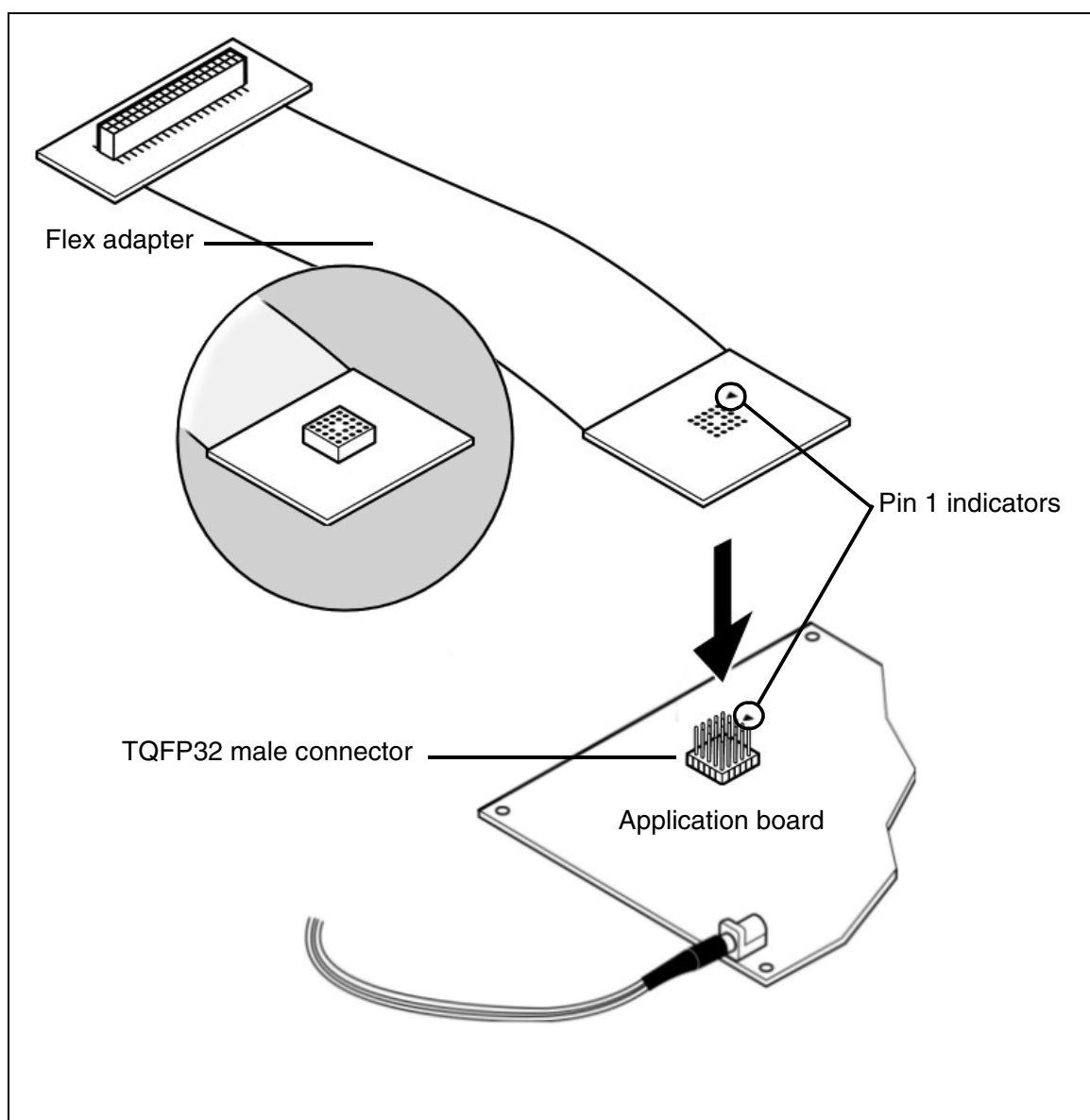

Figure 7: SDIP32 connection scheme

### 3.5 TQFP32 microcontroller package

- 1 Solder the TQFP32 male connector onto your application board.
- 2 Align the pin 1 indicators for the TQFP32 end of the DB522 flex adapter and the TQFP32 male connector on the application board. Then insert the pin of the TQFP32 male connector into the female connector of the DB522 flex adapter as shown in [Figure 8](#).



**Figure 8: TQFP32 (7 x 7) connection scheme**

## 4 EMULATION CHARACTERISTICS

### 4.1 On-chip peripherals configuration

You can configure certain on-chip peripherals in ST7 Visual Develop's **MCU Configuration** dialog box so that the ST7-EMU3 probe accurately emulates your target device.

The on-chip peripheral options available for configuration for the ST7MDT20J-EMU3 TEB are described in this section.

#### MCU

In STVD7's **MCU Selection** window, choose the MCU that you are using in your application. A complete and up-to-date listing of supported MCUs for your ST7MDT20J-EMU3 emulator is provided in the current version of the *STVD7 Release Notes*.

#### Clock

The Clock frequency options are summarized in [Table 2](#) below.

**Table 2: Clock frequency options**

Fosc options	Clock Source
16 MHz	On probe Fixed frequency divided
8 MHz	
4 MHz	
2 MHz	
1 MHz	
500 kHz	
250 kHz	
125 kHz	
62.5 kHz	
Other_freq_kHz	

#### Other\_freq\_kHz

This option allows you to *Enter* the Fosc value in kHz, that will be generated by the Programmable Clock system on probe. When the entered Fosc cannot be generated, a warning message will be displayed giving the two nearest values that the Programmable Clock system is able to generate. The user will have to retype the correct value.



### **CSS (Clock Security System)**

This option allows you to *Enable* or *Disable* the clock security system function (CSS) which includes the clock filter and the backup safe oscillator. When enabled, the selected OSCRANGE is used to determine the operating frequency range, and when the frequency is out of range, the clock source will be switched to the backup oscillator.

### **OSCRANGE**

This option allows you to select the normal operating frequency range for the Clock Security System. The following operating frequency range options are available:

- VLP 32~100 kHz
- LP 1~2 MHz
- MP 2~4 MHz
- MS 4~8 MHz
- HS 8~16 MHz

### **PLL**

This option allows you to *Enable* or *Disable* the PLL which allows the multiplication by two of the main input clock frequency. The PLL is guaranteed only when the input frequency is between 2 and 4 MHz.

### **RSTC (Reset clock cycle selection)**

This option allows you to select the number of CPU cycles applied during the RESET phase and when exiting HALT mode. You can choose between *4096 CPU cycles* and *256 CPU cycles*.

### **VD (Voltage detection)**

This option allows you to enable the voltage detection block (LVD and AVD) with a selected threshold for the LVD and AVD. The options available are:

- *LVD/AVD OFF* — Both LVD and AVD are disabled.
- *Highest Voltage*
- *Medium Voltage*
- *Lowest Voltage*

The last three options are equivalent—regardless of the threshold voltage chosen above (highest, medium or lowest) the threshold applied will be 1.5 V. Refer to

[Emulation functional limitations and discrepancies](#) on page 20 for more information.

### **WDG HALT (Watchdog halt)**

There are two options: *Reset* or *No Reset*. If this option is set to *Reset*, when the Watchdog is enabled and a Halt instruction is encountered in the executable code, a chip reset will be performed. If this option is set to *No Reset*, no chip reset will be performed.

### **WDG (Watchdog)**

This option allows you to choose whether the watchdog timer is enabled by software or by hardware.

Refer to the datasheet of your target ST7 MCU for more information on the watchdog timer.

## 4.2 Emulator electrical characteristics

This section details the specific electrical characteristics of the ST7MDT20J-EMU3 emulator.

### 4.2.1 Power follower characteristics

The application power supply follower converts the application voltage  $V_{APP}$  to a voltage within the range of 2.4 V and 5.5 V. The curve plotted on the graph below shows how the value of  $V_{CC\_EMU}$  evolves with the value of  $V_{APP}$ .

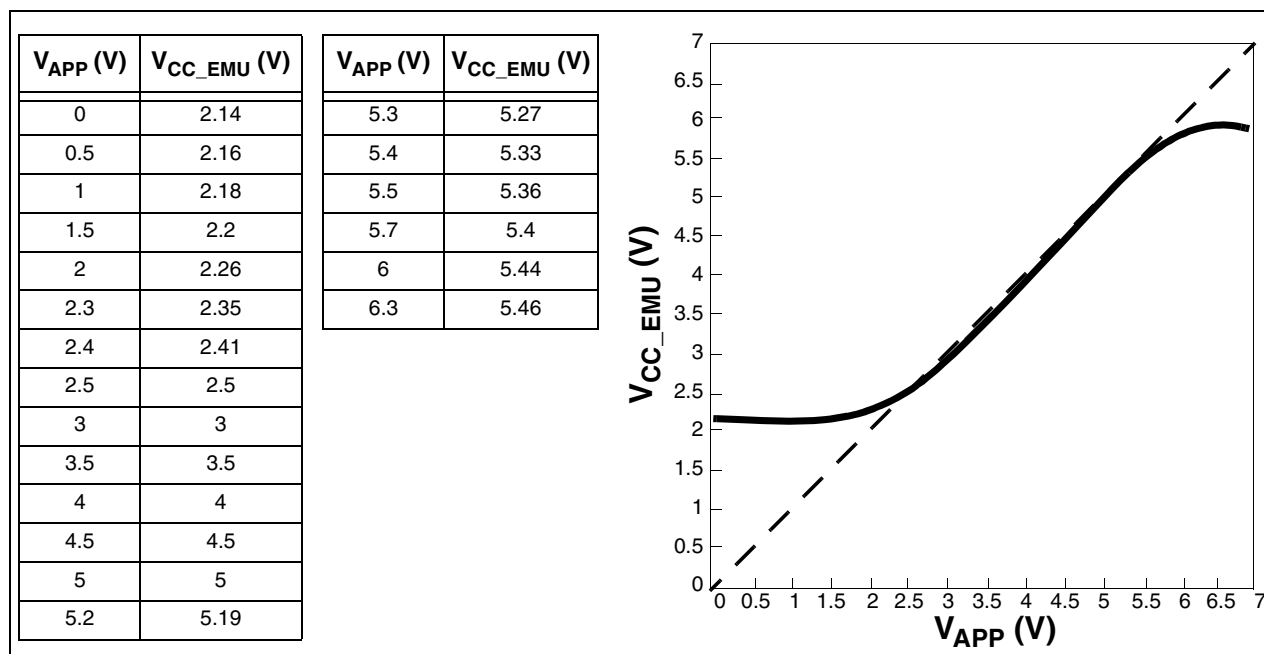

**Figure 9: Power follower behavior**

**Note:** This curve is not necessarily characteristic of all emulators—it is based on measurements taken using a single emulator. Slight differences may occur between emulators.

### 4.3 Emulation functional limitations and discrepancies

Some MCU's may present specific limitations and discrepancies. You will find information specific to your MCU and your hardware configuration in STVD7's **Discrepancies window**. For more information refer to the *STVD7 User Manual*

#### 4.3.1 LVD

In reference to the option *VD (Voltage detection)* on page 17:

- The LVD option is always turned off in HALT/Active HALT mode, no matter what the selected VD option is.
- The LVD thresholds for VDD rise and VDD fall are not compliant with the last version of the datasheet (revision 1.4) for the ST72(F)521/321/324 emulator chip.

## APPENDIX A: EMC CONFORMITY AND SAFETY REQUIREMENTS

This product respects the EMC requirements of the European guideline 89/336/EEC under the following conditions:

- Any tester, equipment, or tool used at any production step, or for any manipulation of semiconductor devices, must have its shield connected to ground.
- All provided ferrites must be attached as described in the hardware installation instructions of the relevant user manual(s).
- The product must be placed on a conductive table top, made of steel or clean aluminum, grounded through a ground cable. Before every contact with the emulator, the operator must touch the surface of the grounded worktable just behind the rear panel of the ST Micro Connect box. All manipulation of finished must be done at such a grounded worktable.
- The worktable must be free of all non-antistatic plastic objects.
- It is recommended that you wear an antistatic wrist or ankle strap, connected to the antistatic floor covering or to the grounded equipment.
- If no antistatic wrist or ankle strap is worn, before each manipulation of the powered-on tool, you must touch the surface of the grounded worktable just behind the rear panel of the ST Micro Connect box.
- It is recommended that antistatic gloves or finger coats be worn.
- It is recommended that nylon clothing be avoided while performing any manipulation of parts.

## APPENDIX B: CHANGING THE TEB IN YOUR ST7 EMU3 PROBE

Each EMU3 probe has a modular design that is made up of three emulation boards. Two boards, the **Common Emulation Board (CEB)** and the **Dedicated Emulation Board (DEB)** are identical for all ST7-EMU3 probes. However, the third board, the **Target Emulation Board (TEB)**, is specific to an ST7 MCU, or a family of ST7 MCUs. Therefore, what makes each EMU3 probe distinct and defines its emulation capabilities, is the type of TEB it contains.

The EMU3 probe has been designed to work with many different Target Emulation Boards (TEBs). This appendix tells you how to replace the TEB in your EMU3 probe.

- 1 Turn the EMU3 probe upside-down, unscrew the retaining screw and slide the bottom out as shown in [Figure 3](#) on page 10.
- 2 Remove the two screws that secure the TEB to the rest of the probe boards, as shown in [Figure 10](#).

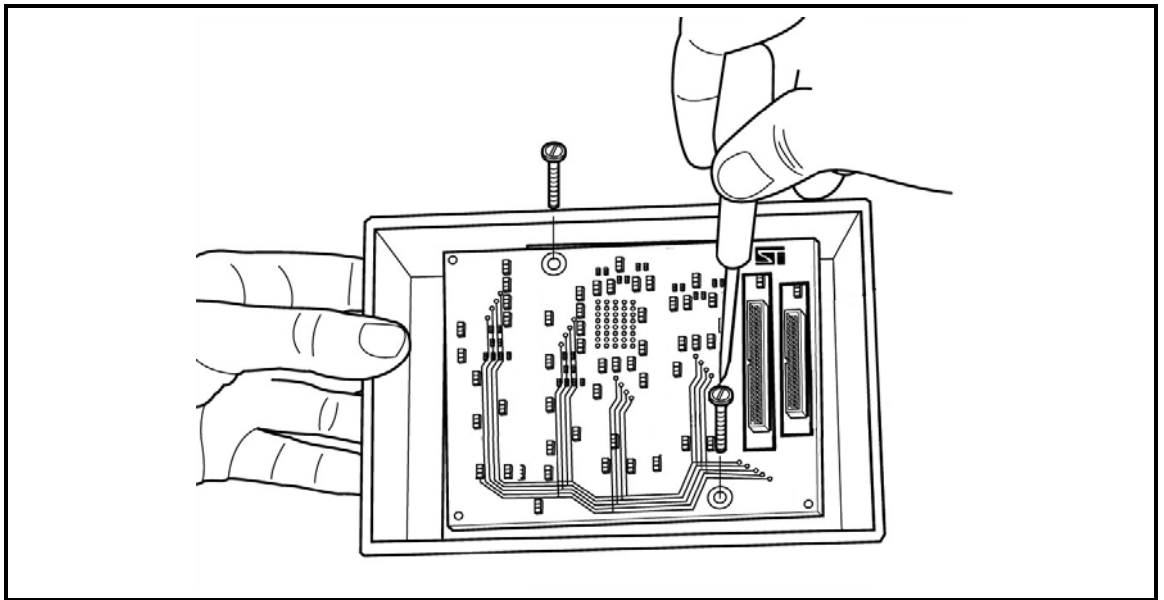

**Figure 10: Removing the TEB screws**

- 3 Remove the target emulation board that is currently in the probe by gripping the edge of the board and pulling it straight out (see [Figure 11](#)). Store it somewhere safe and static-free for future use.

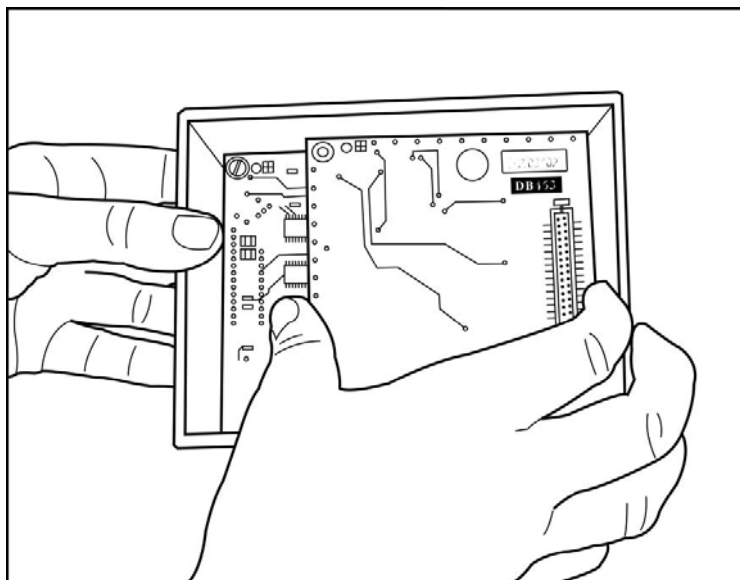

**Figure 11: Removing the TEB**

The board under the TEB – the Dedicated Emulation Board (DEB), should now be visible (see [Figure 12](#)).

- 4 Identify the top and bottom faces of the TEB you wish to install. The bottom face is distinguished by the presence of two or more flex cable connectors placed side by side. The top face is distinguishable by two DEB connectors along the long edges of the TEB. There is one 84-pin connector and one 64-pin connector, which match the DEB connectors shown in [Figure 12](#).

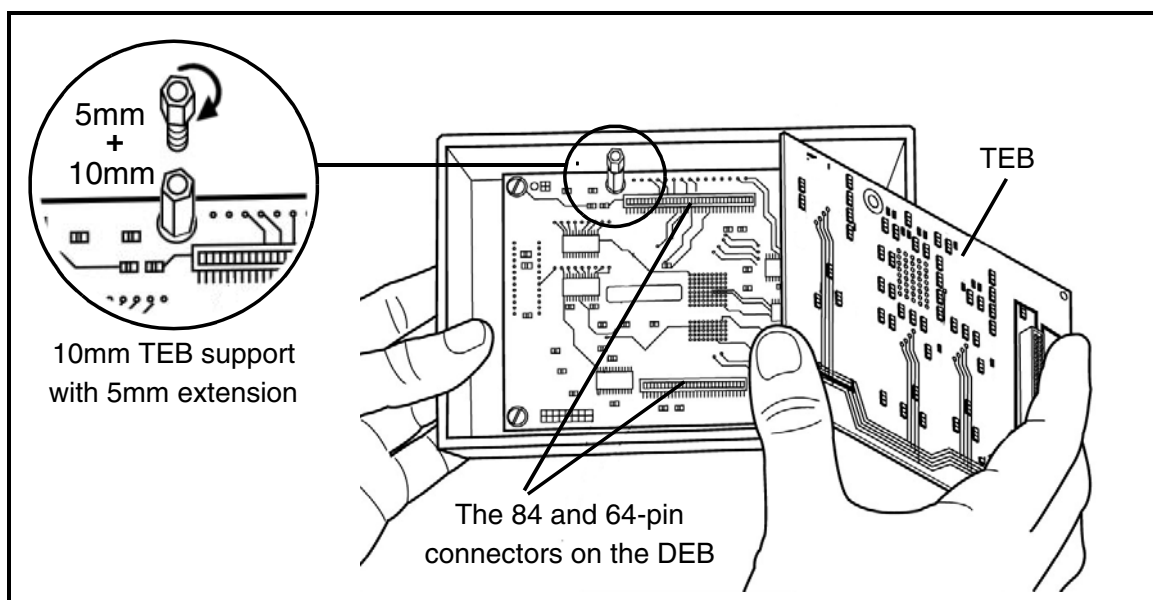

**Figure 12: DEB and TEB connectors**

- 5 Install the replacement TEB in the EMU3 probe by inserting the male 84-pin/64-pin connectors into the TEB's female 84-pin/64-pin connectors (refer to [Figure 12](#)). Because the connectors are asymmetric, there is only one possible connection scheme.

**Note:**

*For some TEBs, the microcontroller is mounted on a support and not soldered directly to the board. In this case the TEB's 84-pin and 64-pin connectors have an additional height of 5mm to allow enough room for the microcontroller. To compensate you will need to add a 5mm extension to the 10mm support on the DEB, as shown in [Figure 12](#) on page 23. The 5mm extensions are provided with your TEB and screw into the 10mm supports. However, remember that if you install a TEB with surface mounted microcontroller later, you will have to remove the 5mm extensions.*

- 6 Once the TEB is firmly in place, refasten the two screws that fix the TEB to the DEB, as shown in [Figure 10](#). Take care not to over-tighten the screws.
- 7 Connect the appropriate flex cable for your MCU package, as described in [Section 3.1: Connecting the flex adapter to the EMU3 probe](#) on page 10.
- 8 Replace the bottom panel of the probe housing such that the flex cable feeds through the slot provided.
- 9 Reconnect the probe to the ST Micro Connect box by connecting the two 80-pin flat cables to the ST Micro Connect connection ports on the top face of the probe housing. For details, refer to the *ST7 EMU3 Emulator User Manual*.

If this is the first time that you have installed a new TEB in your EMU3 probe, your emulator and probe firmware will be updated automatically by STVD7 when you start a debug session. For more information refer to your *STVD7 User Manual*.



## APPENDIX C: DOCUMENT REVISION HISTORY

Date	Revision	Description
Nov 2001	2.0	<ul style="list-style-type: none"> <li>• Updated <a href="#">Product Support</a> – with spare parts information and preparing to call procedure</li> <li>• Updated <a href="#">Section 4.3</a> – with LVD limitation</li> </ul>
Jan 2002	2.1	<ul style="list-style-type: none"> <li>• Updated <a href="#">Section 1</a>, <a href="#">Table 1</a> and <a href="#">Section 4</a> – with new MCUs (ST72344)</li> <li>• Updated <a href="#">Appendix C</a> – Firmware update procedure</li> </ul>
Sep 2002	2.2	<ul style="list-style-type: none"> <li>• Added <a href="#">Figure 2</a> – Delivery check list illustrations</li> <li>• Added <a href="#">Section 3.2</a>, <a href="#">Section 3.3</a>, <a href="#">Section 3.4</a> and <a href="#">Section 3.5</a> – application board connection information by package</li> <li>• Updated <a href="#">Section 3.1</a> – flex adapter installation procedure based on new probe casing design</li> <li>• Updated <a href="#">Appendix C</a> – Firmware update procedure</li> </ul>
Mar 2005	2.3	<ul style="list-style-type: none"> <li>• Added <a href="#">Figure 1</a> – EMU3 terminology and product structure</li> <li>• Updated <a href="#">Section 1</a> – product terminology and description</li> <li>• Added <a href="#">Section 4.2</a> – Emulator electrical characteristics</li> <li>• Updated <a href="#">Section 4.3</a> – with information about STVD7 Discrepancies window</li> <li>• Updated <a href="#">Appendix B</a> – changing the TEB</li> <li>• Removed <a href="#">Appendix C</a> – Firmware update procedure</li> <li>• Added <a href="#">Appendix C</a> – description of user documentation and revision history</li> </ul>

Table 1: ST7MDT20J-EMU3 Probe User Guide Revision History

## PRODUCT SUPPORT

If you experience any problems with this product, or if you need spare parts or repairs, contact the distributor or the STMicroelectronics sales office where you purchased the product. Phone numbers for major sales regions are provided in the [Contact List](#), below.

In addition, at our Internet site [www.st.com/mcu](http://www.st.com/mcu), you will find a complete listing of ST sales offices and distributors, as well as documentation, software downloads and user discussion groups to help you answer questions and stay up to date with our latest product developments.

## Software updates

All our latest software and related documentation are available for download from the ST Internet site, [www.st.com/mcu](http://www.st.com/mcu). For information about firmware and hardware revisions, call your distributor or ST using the [Contact List](#) provided below.

## Hardware spare parts

Your development tool comes with the hardware you need to set it up, connect it to your PC and connect to your application. However, some components can be bought separately if you need additional ones. You can order extra components, such as sockets and adapters, from STMicroelectronics, from the component manufacturer or from a distributor.

### Sockets

Complete documentation and ordering information for P/TQFP sockets from Yamaichi, Ironwood, CAB and Enplas are provided at the following Internet sites:

[www.yamaichi.de](http://www.yamaichi.de)

[www.ironwoodelectronics.com](http://www.ironwoodelectronics.com)

[www.cabgmbh.com](http://www.cabgmbh.com)

[www.enplas.com](http://www.enplas.com)

### Connectors

Complete documentation and ordering information for SAMTEC connectors is provided at [www.samtec.com](http://www.samtec.com).

## Getting prepared before you call

Collect the following information about the product before contacting ST or your distributor:

- 1 Name of the company where you purchased the product.
- 2 Date of purchase.
- 3 Order Code: Refer to the side your emulators box. The order code will depend on the region in which it was ordered (i.e. the UK, Continental Europe or the USA).
- 4 Serial Number: The serial number is found located on the rear panel of the ST Micro Connect box and is also listed on the Global Reference card provided with the emulator.
- 5 TEB (Target Emulation Board) hardware and firmware versions: The hardware and firmware versions can be found by opening an STVD7 session, entering the debug context and selecting **Help>About** from the main menu. The TEB version numbers are given in the *Target box* – scroll downwards until you find the TEB version (hardware) and TEB PLD version (firmware).
- 6 Target Device: The sales type of the ST microcontroller you are using in your application.

# Contact List

## North America

---

### Canada and East Coast

STMicroelectronics  
Lexington Corporate Center  
10 Maguire Road, Building 1, 3rd floor  
Lexington, MA 02421  
Phone: (781) 402-2650

### Mid West

STMicroelectronics  
1300 East Woodfield Road, Suite 410  
Schaumburg, IL 60173  
Phone: (847) 585-3000

### West coast

STMicroelectronics, Inc.  
1060 E. Brokaw Road  
San Jose, CA 95131  
Phone: (408) 452-8585

*Note: For American and Canadian customers seeking technical support the US/Canada is split in 3 territories. According to your area, contact the appropriate sales office from the list above and ask to be transferred to an 8-bit microcontroller Field Applications Engineer.*

## Europe

---

**France** +33 (0)1 47 40 75 75

**Germany** +49 89 46 00 60

**U.K.** +44 162 889 0800

## Asia/Pacific Region

---

**Japan** +81 3 3280 4120

**Hong-Kong** +85 2 2861 5700

**Sydney** +61 2 9580 3811

**Taipei** +88 6 2 2378 8088

Information furnished is believed to be accurate and reliable. However, STMicroelectronics assumes no responsibility for the consequences of use of such information nor for any infringement of patents or other rights of third parties which may result from its use. No license is granted by implication or otherwise under any patent or patent rights of STMicroelectronics. Specifications mentioned in this publication are subject to change without notice. This publication supersedes and replaces all information previously supplied. STMicroelectronics products are not authorized for use as critical components in life support devices or systems without express written approval of STMicroelectronics.

The ST logo is a registered trademark of STMicroelectronics.  
All other names are the property of their respective owners

© 2005 STMicroelectronics - All rights reserved

STMicroelectronics group of companies

Australia – Belgium - Brazil - Canada - China – Czech Republic - Finland - France - Germany - Hong Kong - India - Israel - Italy - Japan -  
Malaysia - Malta - Morocco - Singapore - Spain - Sweden - Switzerland - United Kingdom - United States of America

**[www.st.com](http://www.st.com)**