

## Single Supply, Rail-to-Rail Output Dual Operational Amplifier

### ■ GENERAL DESCRIPTION

The NJM8202 is a Rail-to-Rail output single supply dual operational amplifier with a low noise of  $10\text{nV}/\sqrt{\text{Hz}}$  (typ. at 1kHz) and high RF noise immunity.

The high RF noise immunity can reduce malfunctions caused by RF noises from mobile phones and others.

It offers a single supply voltage operation from +2.5V to +14V, rail-to-rail output swing close to both rails and input voltage range from ground. It is suitable for various applications such as current sense amplifiers, sound processing, buffer amplifiers, filter circuits and others. The NJM8202 is available in small surface mounting packages of SOP8 (DMP8), SSOP8, SOP8 JEDEC 150mil, MSOP8 (VSP8) and MSOP8 (TVSP8).

### ■ FEATURES

- RF Immunity Enhance the RF immunity from mobile phones
- Rail-to-Rail Output 0.25V~4.75V min. (@V+=5V)
- Operating Temperature  $-40^{\circ}\text{C} \sim +85^{\circ}\text{C}$
- Operation Voltage +2.5V~+14V( $\pm 1.25 \sim \pm 7\text{V}$ )
- Slew Rate 3.5V/ $\mu\text{s}$ (typ.)
- GBW 10MHz(typ.)
- Low Noise 10nV/ $\sqrt{\text{Hz}}$ (typ.) @1kHz
- Input Offset Voltage 6.0mV(max.)
- Supply Current 5mA(max.)
- Package DMP8, SSOP8, SOP8 JEDEC 150mil MSOP8 (VSP8) MEET JEDEC MO-187-DA MSOP8 (TVSP8) MEET JEDEC MO-187-DA / THIN TYPE

### ■ APPLICATIONS

- Note PC, PDA
- Mobile phone
- Audio signal processing
- Current detect
- Buffer, Active filter

### ■ TYPICAL APPLICATION

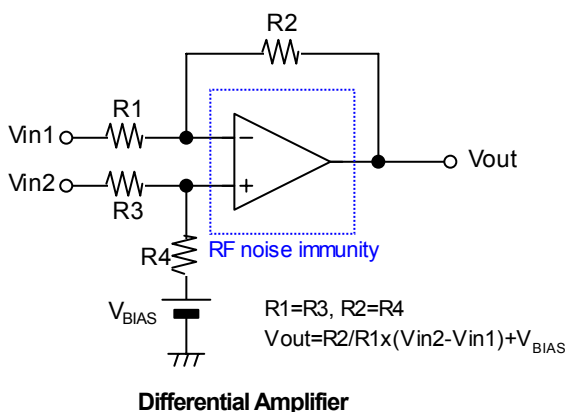

### ■ PACKAGE OUTLINE



**NJM8202M (DMP8)**



**NJM8202E (SOP8)**



**NJM8202V (SSOP8)**



**NJM8202R (MSOP8(VSP8))**



**NJM8202RB1 (MSOP8(TVSP8))**

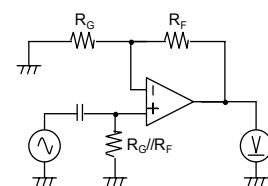
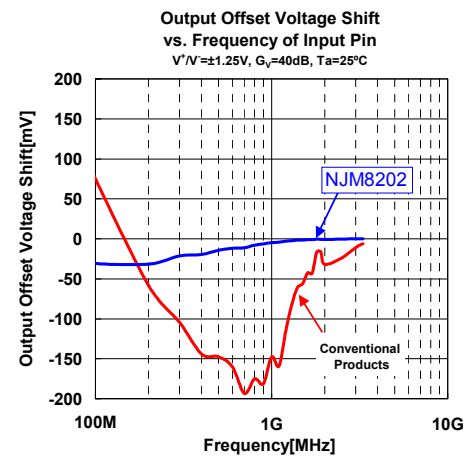

**Test Circuit**

### ■ PIN CONFIGURATION

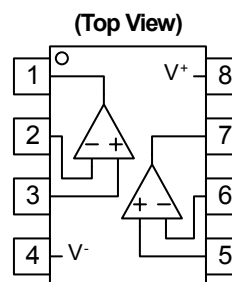

#### Pin Function

1. A OUTPUT
2. A -INPUT
3. A +INPUT
4. V<sup>-</sup>
5. B +INPUT
6. B -INPUT
7. B OUTPUT
8. V<sup>+</sup>

# NJM8202

## ■ ABUSOLUTE MAXIMUM RATINGS (Ta=25°C)

PARAMETER	SYMBOL	RATING	UNIT
Supply Voltage	V <sup>+</sup>	15	V
Common Mode Input Voltage Range	V <sub>ICM</sub>	0~15 (Note1)	V
Differential Input Voltage Range	V <sub>ID</sub>	±15 (Note1)	V
Power Dissipation (Note3)	P <sub>D</sub>	380 [DMP8], 530 [DMP8](Note2) 300 [EMP8], 690 [EMP8] (Note2) 250[SSOP8], 460[SSOP8] (Note2) 320[MSOP8 (VSP8)], 595[MSOP8 (VSP8)] (Note2) 320[MSOP8 (TVSP8)], 580[MSOP8 (TVSP8)] (Note2)	mW
Operating Temperature Range	Topr	-40~+85	°C
Storage Temperature Range	Tstg	-50~+150	°C

(Note1) For supply voltage less than 15V, the absolute maximum input voltage is equal to supply voltage.

(Note2) On the PCB "EIA/JEDEC (114.3×76.2×1.57mm, 2 layers, FR-4)"

(Note3) See Figure1 "Power Dissipation Derating Curve" when ambient temperature is over 25°C.

**Figure1**  
Power Dissipation Derating Curve

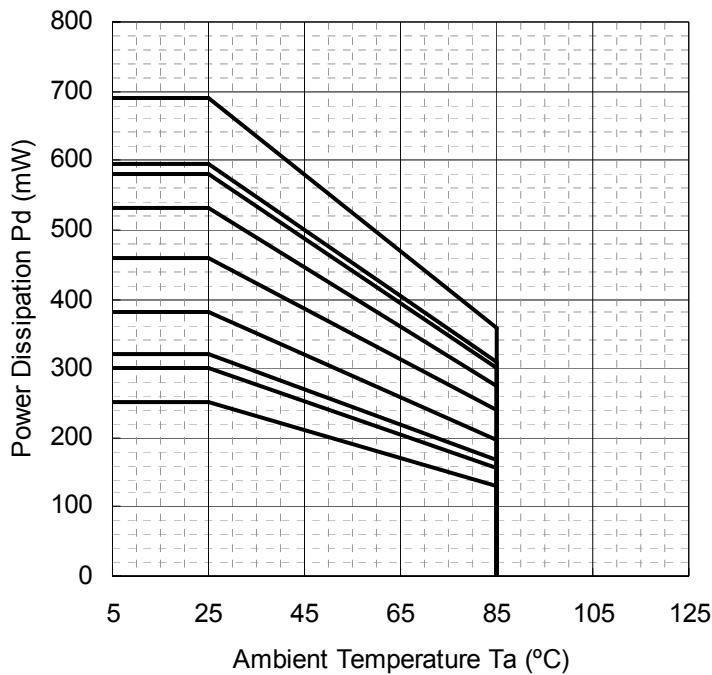

Pkg.	$\Delta Pd$ (mW/°C)	Pd (25°C)	Pd (85°C)
DMP8	-3.04	380	198
EMP8	-2.40	300	156
SSOP8	-2.00	250	130
MSOP8 (TVSP8)	-2.56	320	166
MSOP8 (VSP8)	-2.56	320	166
DMP8(2 Layer)	-4.24	530	276
EMP8(2 Layer)	-5.52	690	359
SSOP8(2 Layer)	-3.68	460	239
MSOP8 (TVSP8)(2 Layer)	-4.64	580	302
MSOP8 (VSP8)(2 Layer)	-4.76	595	309

## ■ RECOMMENDED OPERATING VOLTAGE (Ta=25°C)

PARAMETER	SYMBOL	TEST CONDITION	MIN.	TYP.	MAX.	UNIT
Supply Voltage	V <sup>+</sup>		2.5	-	14	V

■ ELECTRICAL CHARACTERISTICS

● ELECTRICAL CHARACTERISTICS (  $V^+ = 5V$ ,  $T_a = 25^\circ C$  )

PARAMETER	SYMBOL	TEST CONDITION	MIN.	TYP.	MAX.	UNIT
Supply Current	$I_{CC}$	$R_L = \infty$ , $V_{IN} = 2.5V$ , No Signal	-	4	5	mA
Input Offset Voltage	$V_{IO}$		-	1	6	mV
Input Bias Current	$I_B$		-	100	350	nA
Input Offset Current	$I_{IO}$		-	5	100	nA
Voltage Gain	$A_v$	$R_L \geq 10k\Omega$ to 2.5V, $V_o = 0.5V \sim 4.5V$	65	85	-	dB
Common Mode Rejection Ratio	CMR	$0V \leq V_{CM} \leq 4V$	60	75	-	dB
Supply Voltage Rejection Ratio	SVR	$V^+ = 2.5V$ to 14V	60	80	-	dB
Maximum Output Voltage1	$V_{OH1}$	$R_L \geq 5k\Omega$ to 2.5V	4.75	4.9	-	V
	$V_{OL1}$	$R_L \geq 5k\Omega$ to 2.5V	-	0.1	0.25	V
Maximum Output Voltage2	$V_{OH2}$	$R_L \geq 5k\Omega$ to GND	4.75	4.9	-	V
	$V_{OL2}$	$R_L \geq 5k\Omega$ to GND	-	-	0.25	V
Common Mode Input Voltage Range	$V_{ICM}$	CMR $\geq 60$ dB	0	-	4	V
Gain Bandwidth Product	GB	$f = 1$ MHz	-	10	-	MHz
Phase Margin	$\Phi_M$	$R_L = 10k\Omega$ , $C_L = 10$ pF	-	50	-	deg
Equivalent Input Noise Voltage	$V_{NI}$	$f = 1$ kHz, $V_{CM} = 2.5V$	-	10	-	nV/ $\sqrt{Hz}$
Total Harmonic Distortion	THD	$f = 1$ kHz, $A_v = +2$ , $R_L = 10k\Omega$ to 2.5V, $V_o = 1.5V_{rms}$	-	0.001	-	%
Channel Separation	CS	$f = 1$ kHz, $R_L = 10k\Omega$ to 2.5V, $V_o = 1.5V_{rms}$	-	120	-	dB
Slew Rate	SR	(Note4), $A_v = 1$ , $V_{IN} = 2V_{pp}$ $R_L = 10k\Omega$ to 2.5V, $C_L = 10$ pF to 2.5V	-	3.5	-	V/ $\mu s$

(Note4) Number specified is the slower of the positive and negative slew rates.

## ■ TYPICAL CHARACTERISTICS

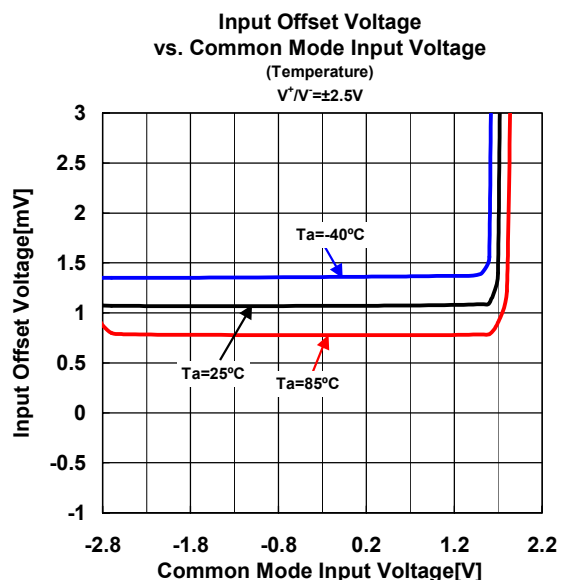
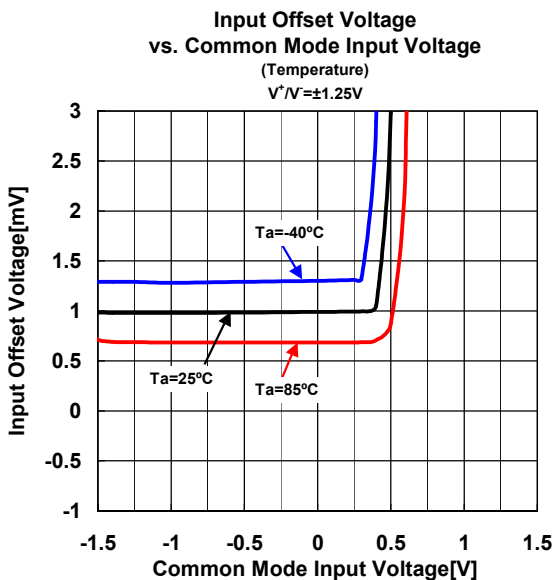
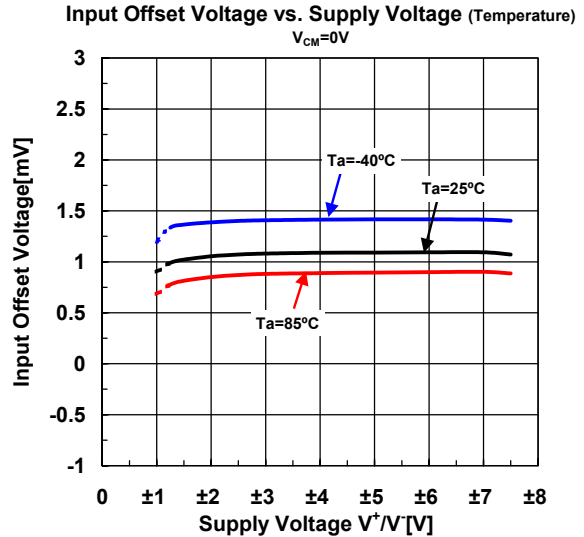
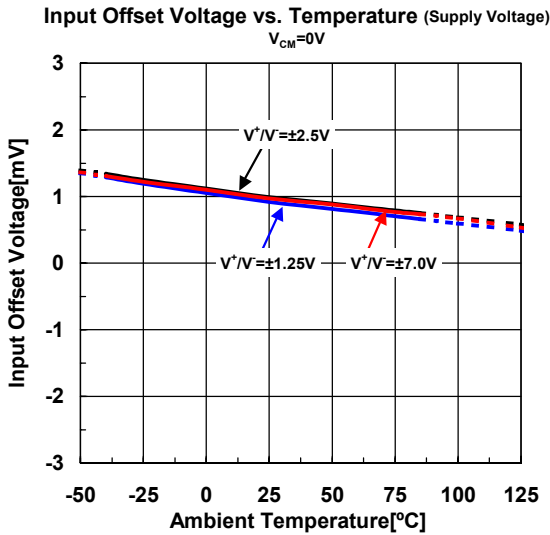
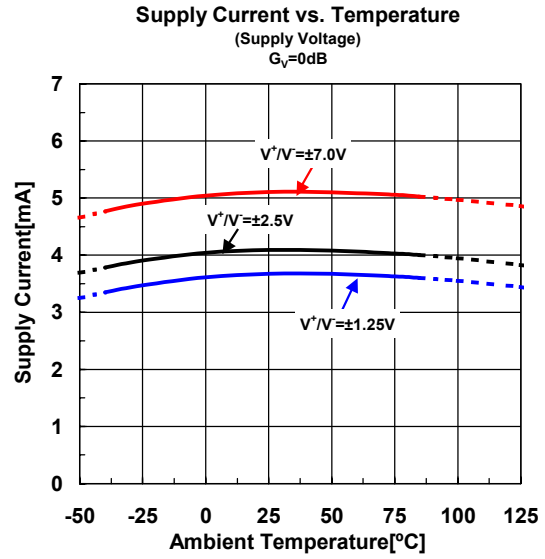
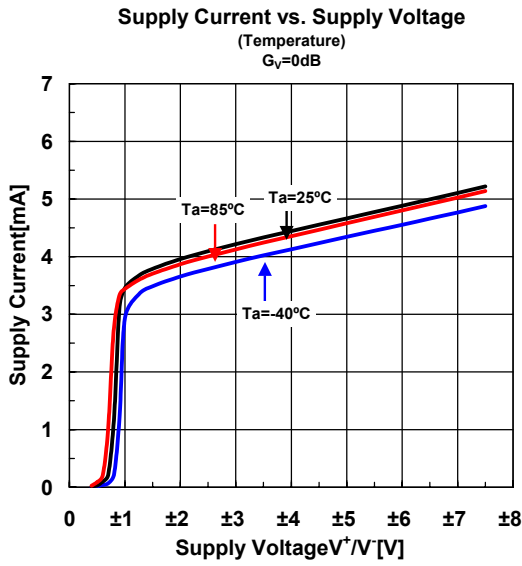

## ■ TYPICAL CHARACTERISTICS

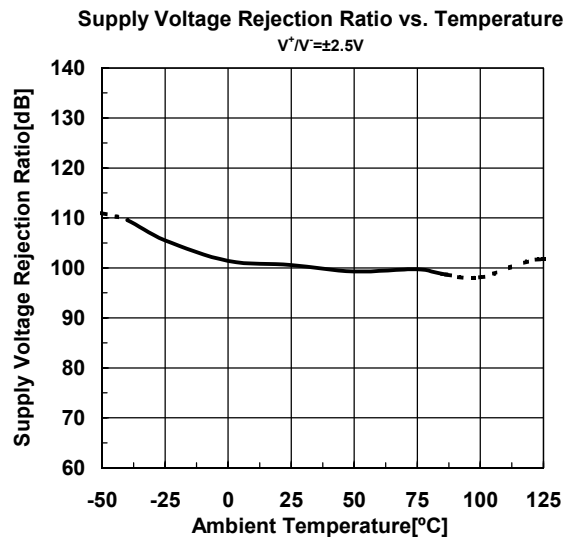
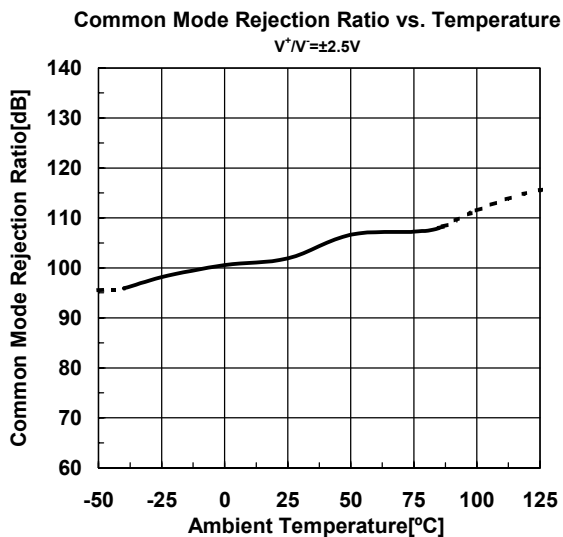
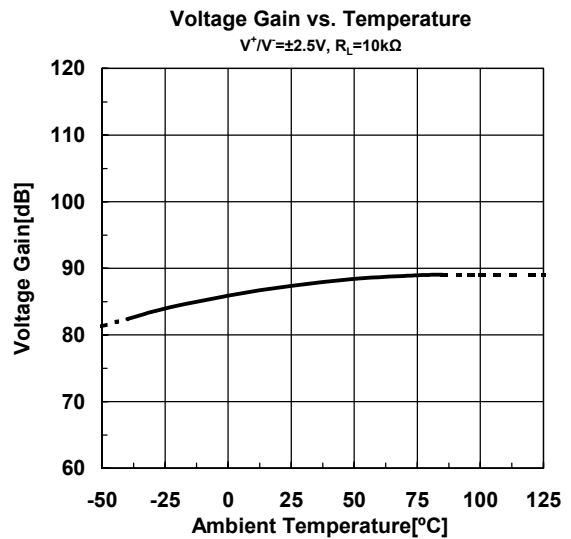
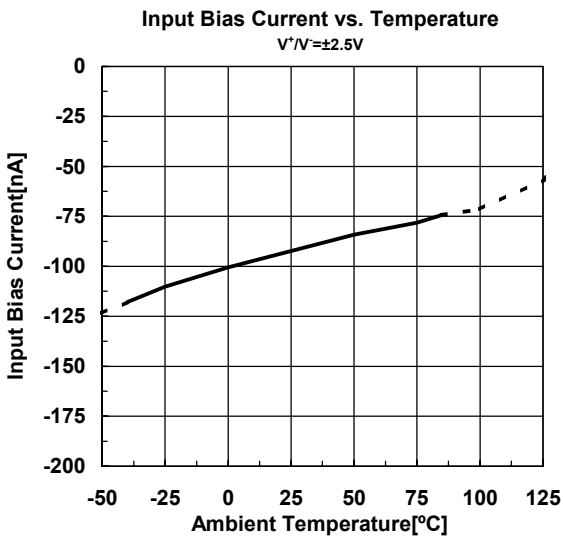
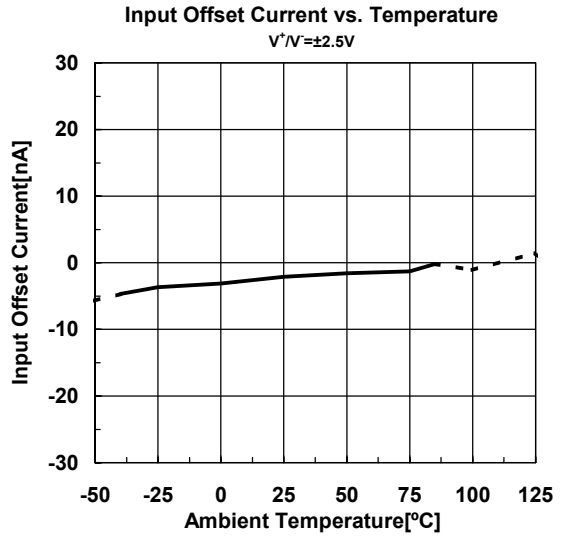
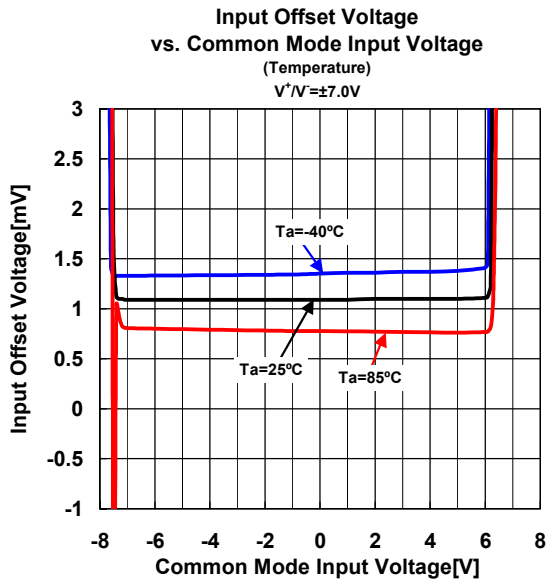

## ■ TYPICAL CHARACTERISTICS

Maximum Output Voltage vs. Load Resistance (Temperature)  
 $V^*/V = \pm 1.25V$ ,  $G_v = \text{open}$

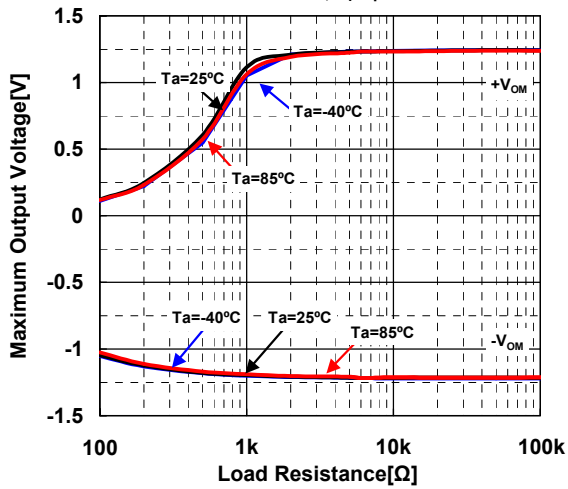

Maximum Output Voltage vs. Output Current (Temperature)  
 $V^*/V = \pm 1.25V$ ,  $G_v = \text{open}$

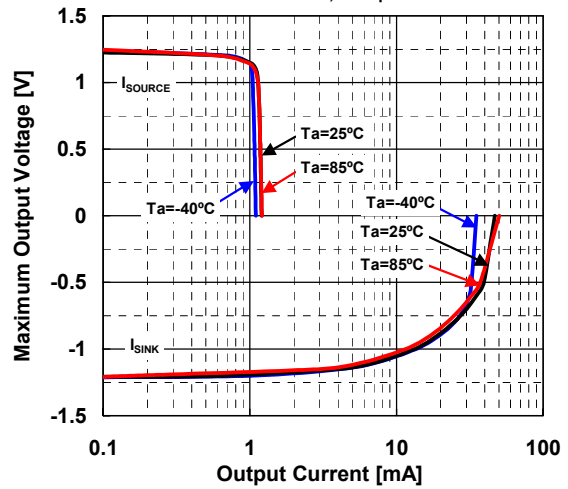

Maximum Output Voltage vs. Load Resistance (Temperature)  
 $V^*/V = \pm 2.5V$ ,  $G_v = \text{open}$

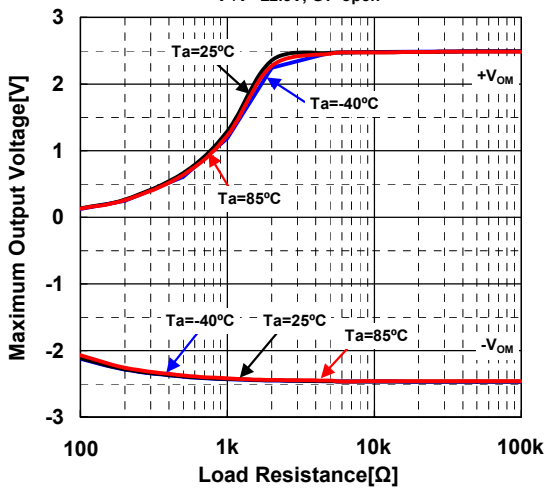

Maximum Output Voltage vs. Output Current (Temperature)  
 $V^*/V = \pm 2.5V$ ,  $G_v = \text{open}$

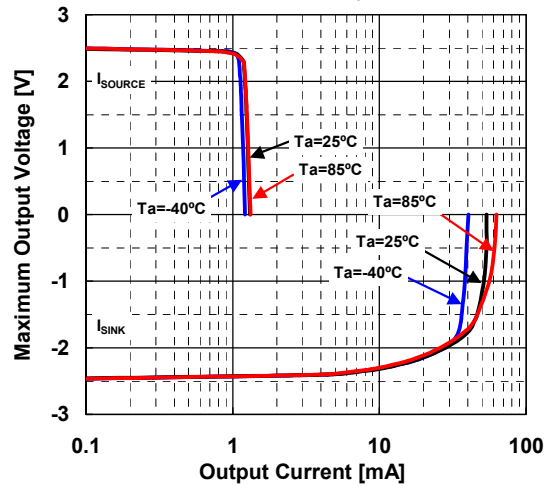

Maximum Output Voltage vs. Load Resistance (Temperature)  
 $V^*/V = \pm 7.0V$ ,  $G_v = \text{open}$

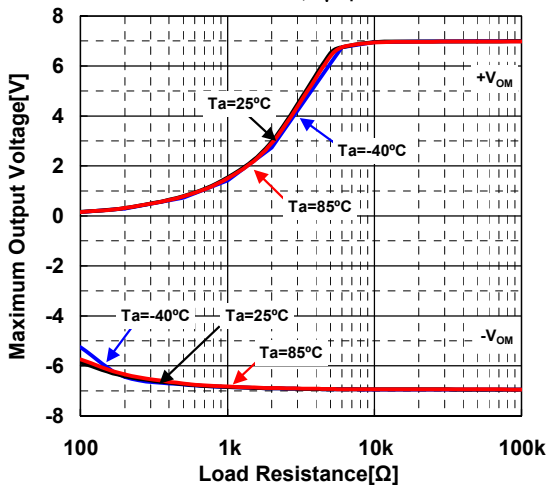

Maximum Output Voltage vs. Output Current (Temperature)  
 $V^*/V = \pm 7.0V$ ,  $G_v = \text{open}$

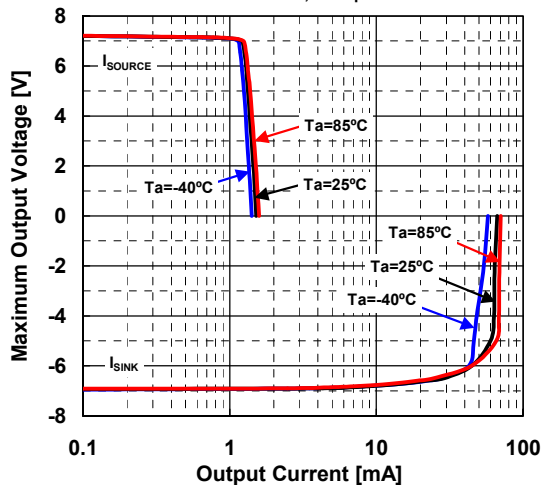

## ■ TYPICAL CHARACTERISTICS

**Maximum Output Voltage vs. Supply Voltage (Temperature)**  
 $G_v = \text{open}, R_L = 5k\Omega$

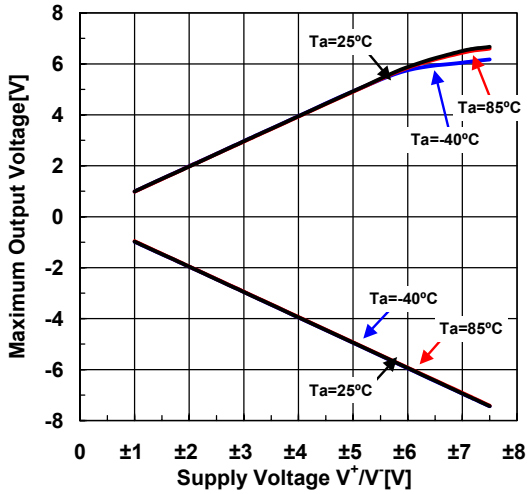

**Maximum Output Voltage vs. Supply Voltage (Temperature)**  
 $G_v = \text{open}, R_L = 10k\Omega$

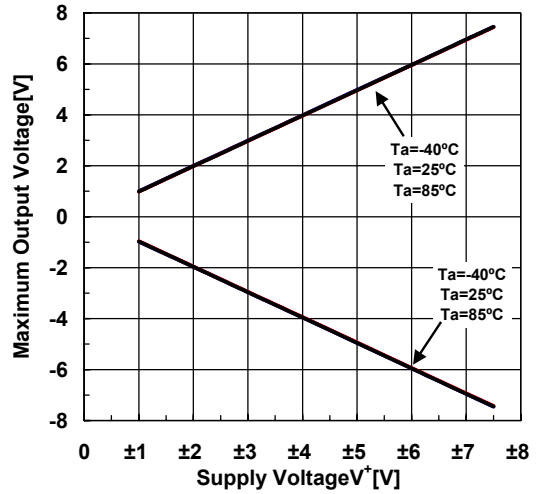

**40dB Gain/Phase vs. Frequency (Temperature)**  
 $V^+/V^- = \pm 1.25V, V_{IN} = -30dBm, G_v = 40dB, R_f = 10k\Omega, C_L = 10pF$

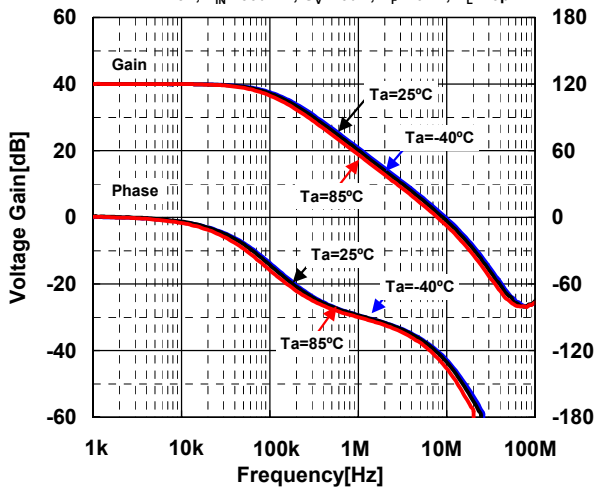

**40dB Gain/Phase vs. Frequency (Load Capacitance)**  
 $V^+/V^- = \pm 1.25V, V_{IN} = -30dBm, G_v = 40dB, R_f = 10k\Omega, Ta = 25^\circ C$

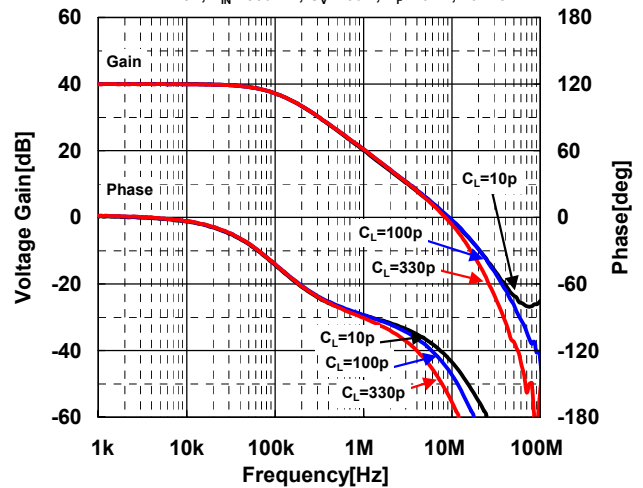

**40dB Gain/Phase vs. Frequency (Temperature)**  
 $V^+/V^- = \pm 2.5V, V_{IN} = -30dBm, G_v = 40dB, R_f = 10k\Omega, C_L = 10pF$

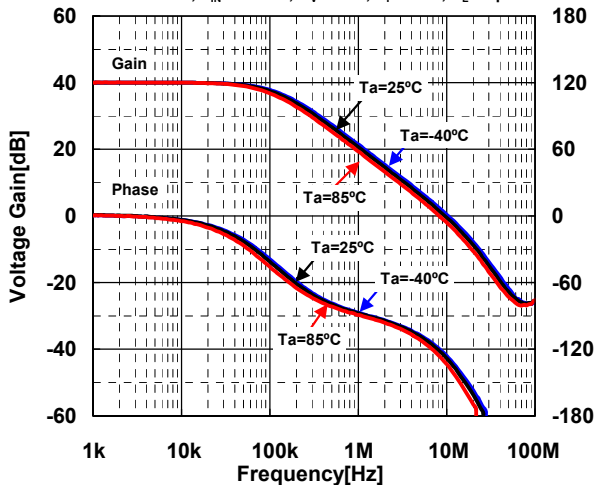

**40dB Gain/Phase vs. Frequency (Load Capacitance)**  
 $V^+/V^- = \pm 2.5V, V_{IN} = -30dBm, G_v = 40dB, R_f = 10k\Omega, Ta = 25^\circ C$

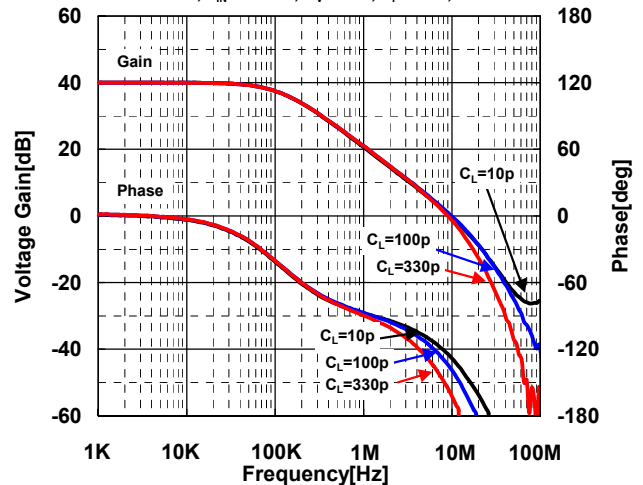

## ■ TYPICAL CHARACTERISTICS

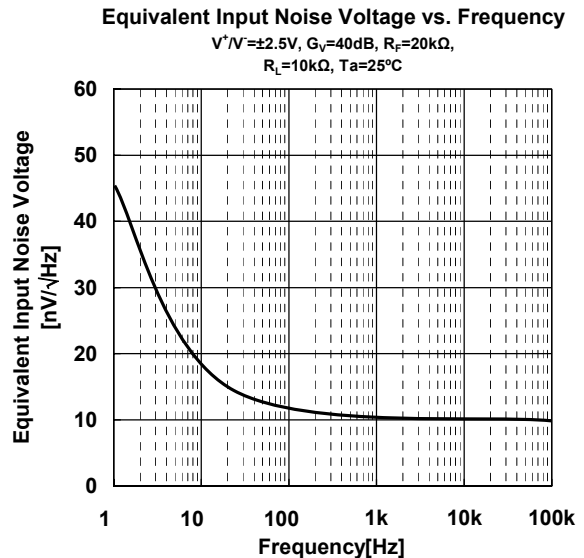
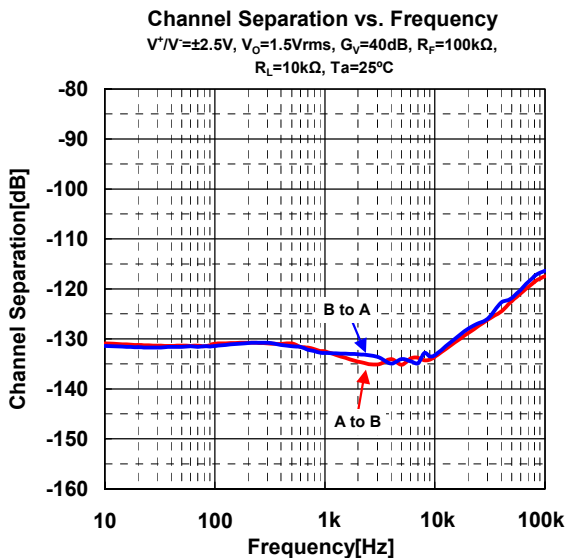
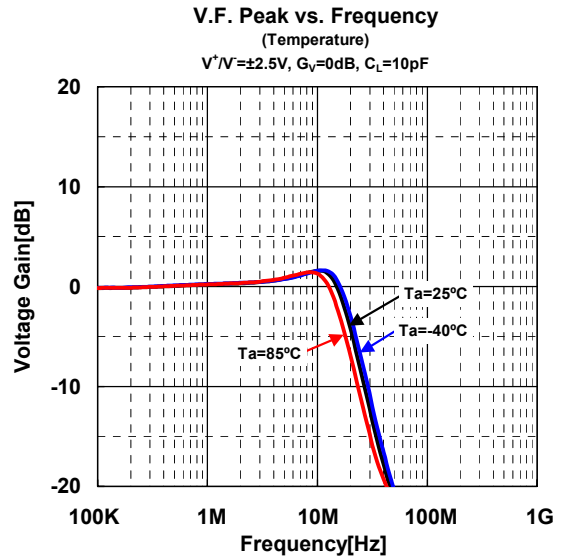
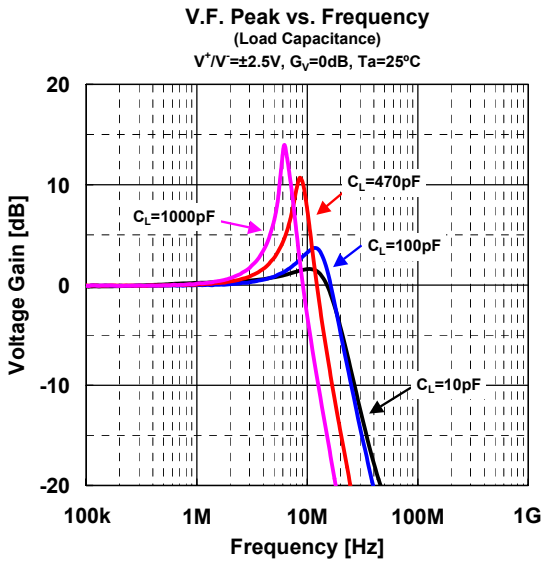
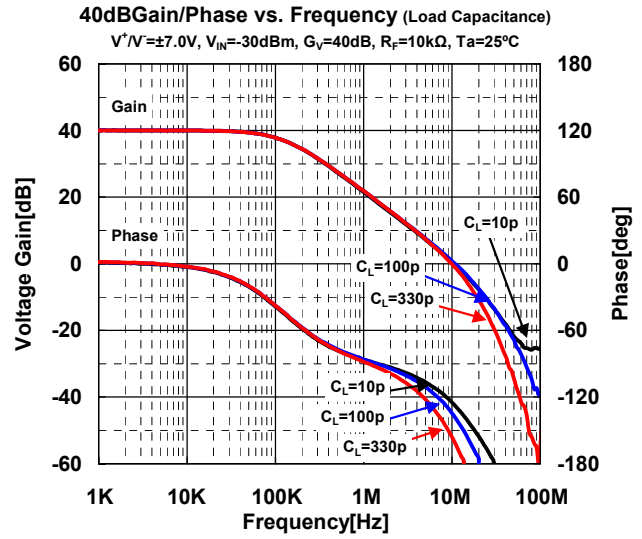
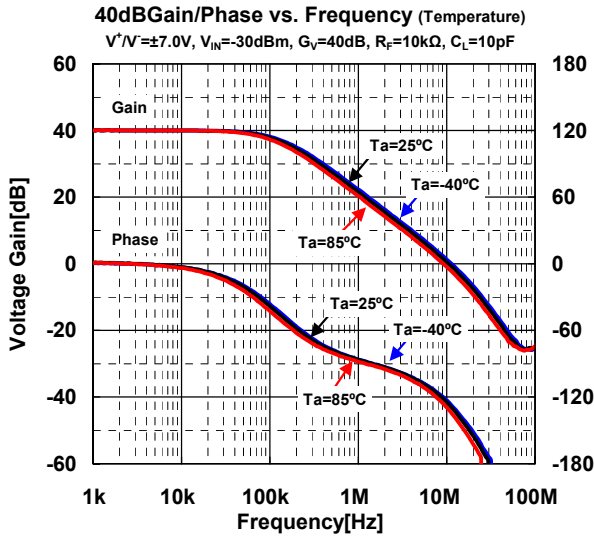



## ■ TYPICAL CHARACTERISTICS

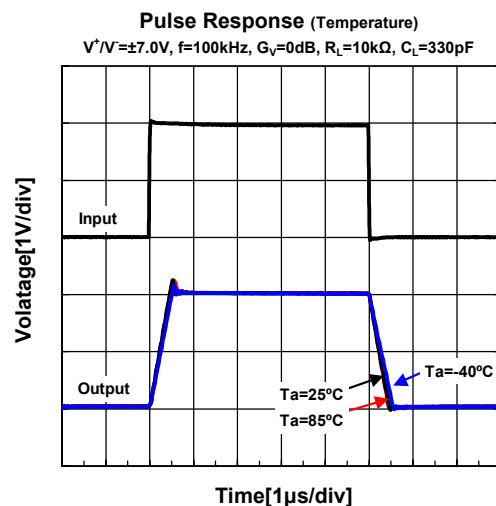
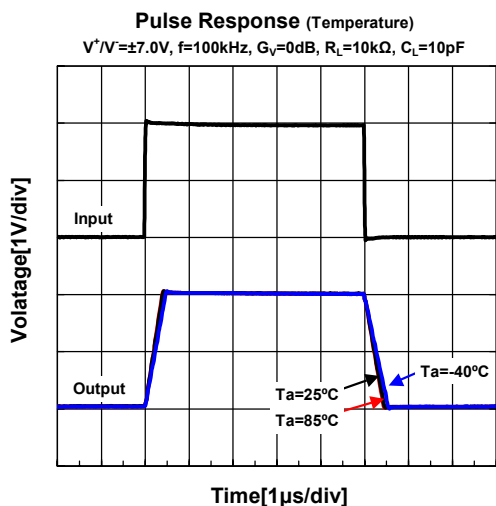
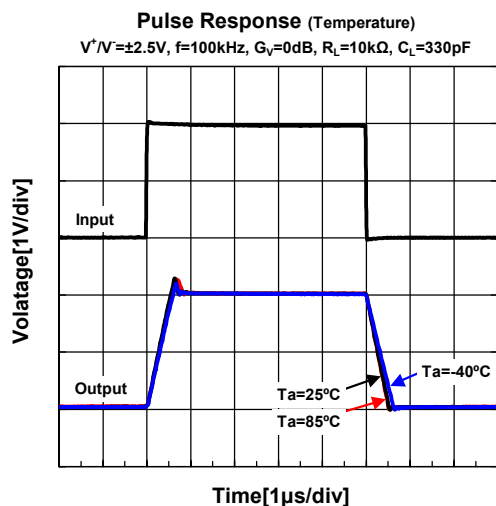
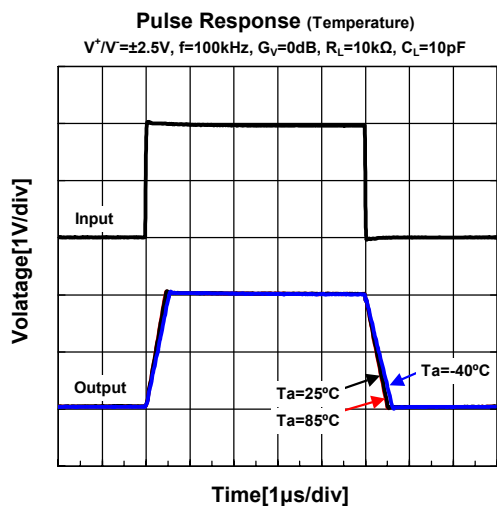
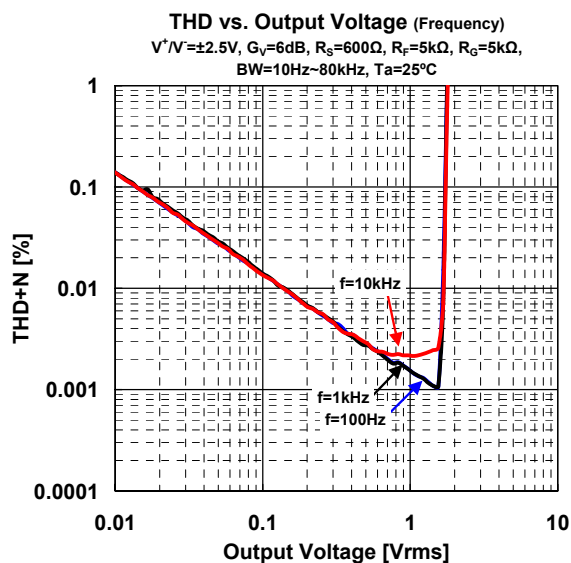
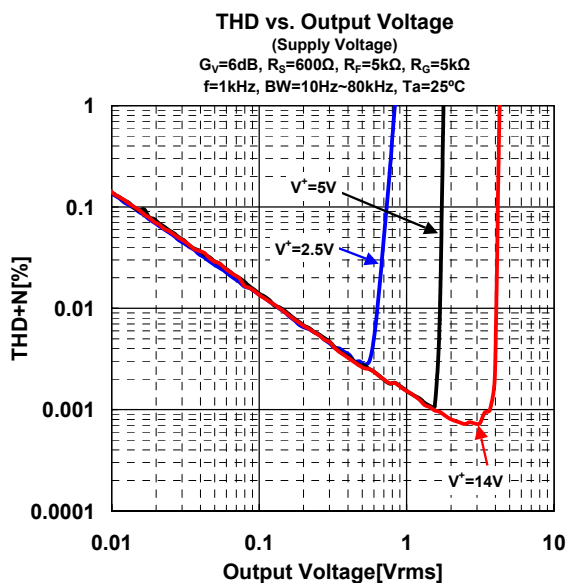

## ■ MEMO

[CAUTION]  
The specifications on this data book are only given for information, without any guarantee as regards either mistakes or omissions. The application circuits in this data book are described only to show representative usages of the product and not intended for the guarantee or permission of any right including the industrial rights.