

Part No. 1002295

Wi-Fi / BT Single Band Stamped Metal Embedded Antenna

2.4 GHz

Supports: Wi-Fi applications, Agriculture, Automotive, Bluetooth, Zigbee, WLAN, Smart Home, Healthcare, Digital Signage



Stamped Metal Wi-Fi/BT Embedded Antenna

2.400 – 2.485 GHz

KEY BENEFITS

Stay-in-Tune

KYOCERA AVX antenna technology provides superior RF field containment, resulting in less interaction with surrounding components.

Quicker Time-to-Market

By optimizing antenna size, performance and emissions, customer and regulatory specifications are more easily met.

Reliability

Products are the latest RoHS version compliant.

APPLICATIONS

- Embedded design
- Cellular, Headsets, Tablets
- Gateway, Access Point
- Handheld
- Telematics
- Tracking
- Healthcare
- M2M, Industrial devices
- Smart Grid
- OBD-II

KYOCERA AVX Stamped Metal antennas deliver on the key needs of device designers for higher functionality and performance in smaller/thinner designs. These innovative antennas provide compelling advantages for WLAN enabled devices, media players, routers, and other wireless devices.

Greater Flexibility

KYOCERA AVX first-in-class technology enables you to develop concept designs that are more advanced and that deliver superior performance in reception critical applications.

Electrical Specifications

Typical performance on 75 x 75 mm PCB

Frequency	2.400 - 2.485 GHz
Peak Gain	4.4 dBi
Average Efficiency	79%
VSWR Match	2.0 :1 max
Feed Point Impedance	50 ohms unbalanced
Polarization	Linear
Power Handling	0.5 Watt CW

Mechanical Specifications & Ordering Part Number

Ordering Part #	1002295
Dimensions (mm)	16.1 x 15.7 x 10.55
Mounting Type	SMT (P&P)
Weight (grams)	0.70
Packaging	Tape & Reel, 150 pcs/Reel
Demo Board	1003666-01

2.4 GHz Stamped Metal KYOCERA AVX Embedded Antenna Specifications
 KYOCERA AVX produces a wide variety of standard and custom antennas to meet user needs.

Antenna Dimensions

Typical antenna dimensions (mm)

Part Number	A (mm)	B (mm)	C (mm)
1002295	16.1 ± 0.4	15.7 ± 0.3	10.55 ± 0.4

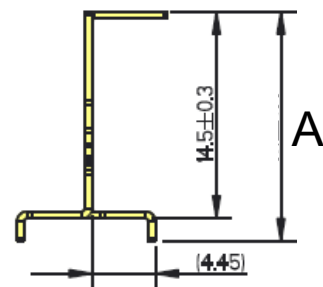
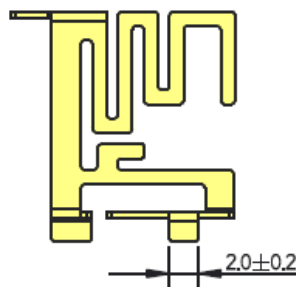
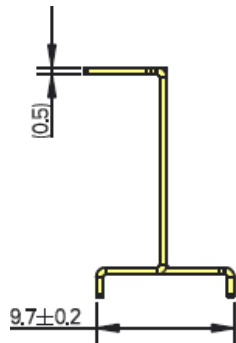
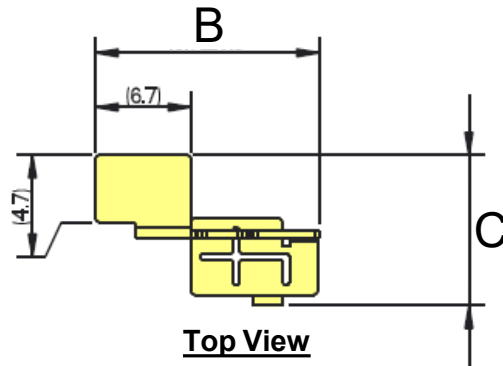
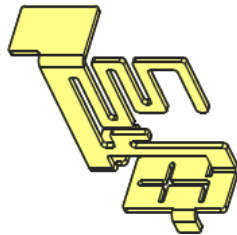

Pin#	Description
1	Feed
2	Ground

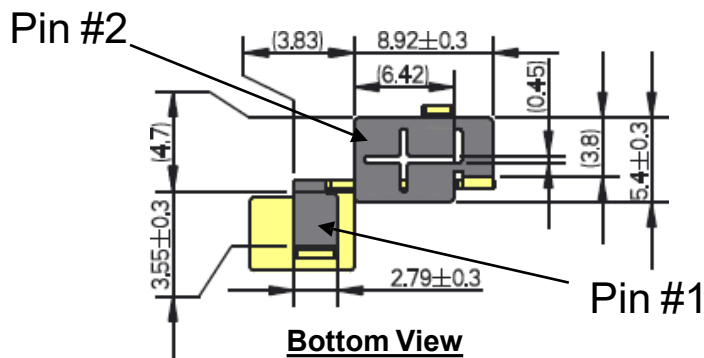

2.4 GHz Stamped Metal KYOCERA AVX Embedded Antenna Specifications
 KYOCERA AVX produces a wide variety of standard and custom antennas to meet user needs.

VSWR and Efficiency Plots

Typical performance on 75 x 75 mm PCB

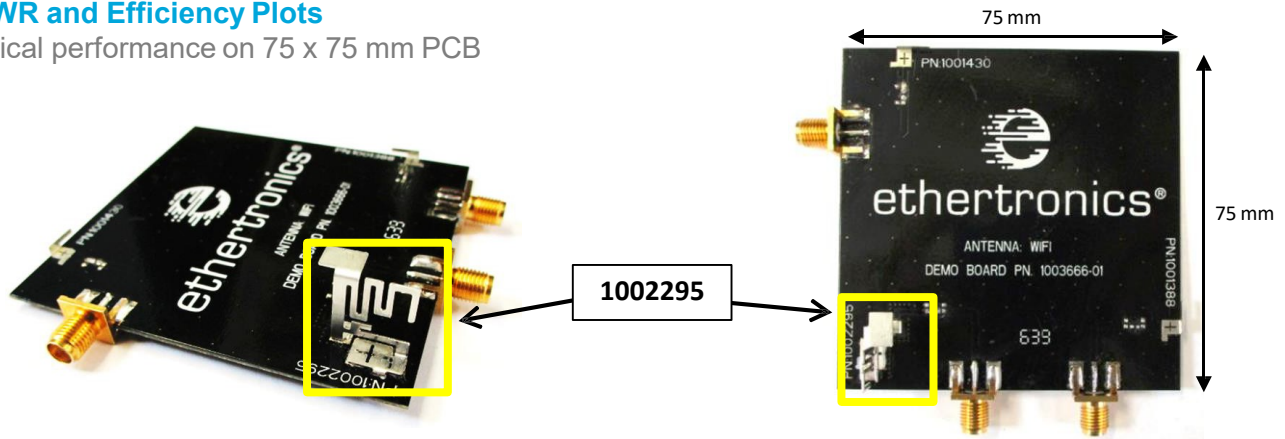

VSWR

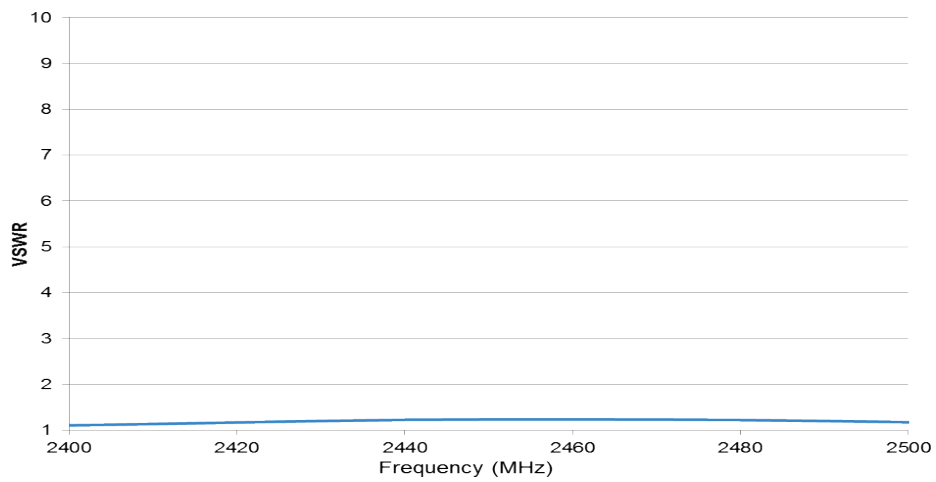

Efficiency

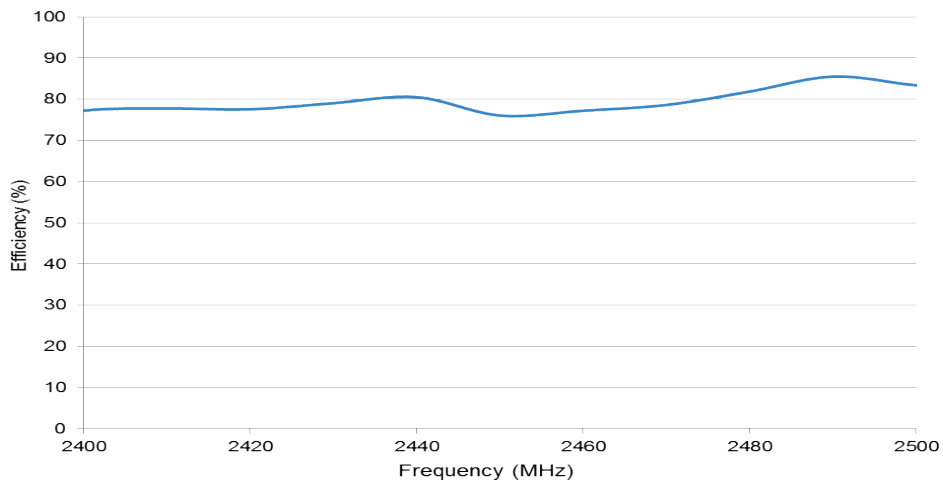

2.4 GHz Stamped Metal KYOCERA AVX Embedded Antenna Specifications
 KYOCERA AVX produces a wide variety of standard and custom antennas to meet user needs.

Antenna Radiation Patterns

Typical performance on 75 x 75 mm PCB
 Measured at 2450 MHz

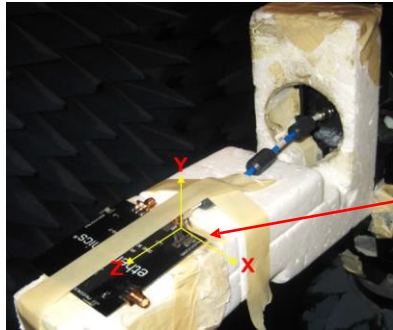

1002295

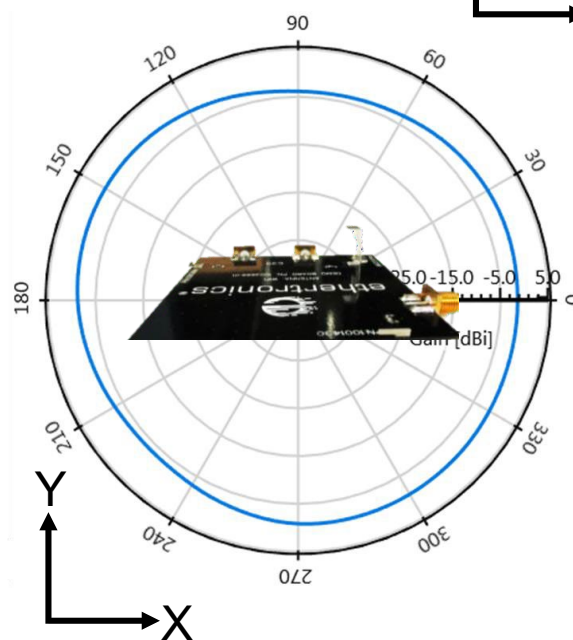
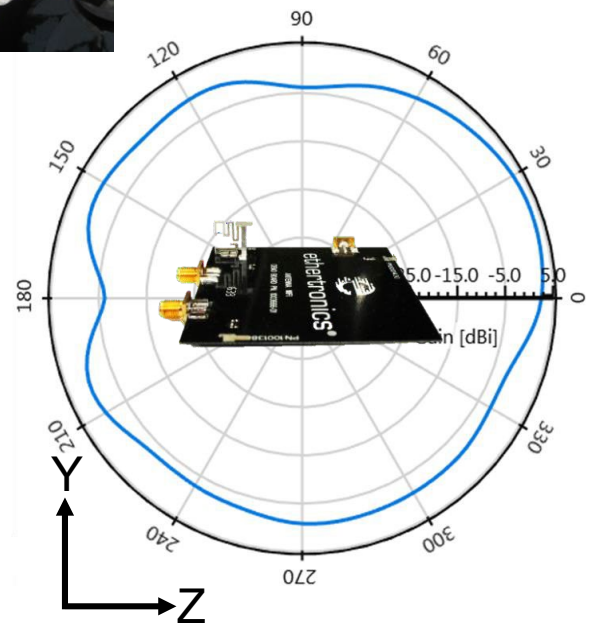
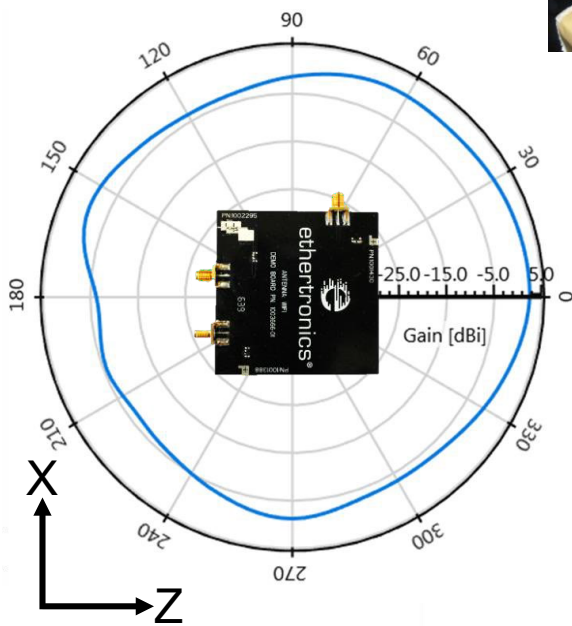

2.4 GHz Stamped Metal KYOCERA AVX Embedded Antenna Specifications
 KYOCERA AVX produces a wide variety of standard and custom antennas to meet user needs.

Antenna Layout

Typical layout dimensions (mm)

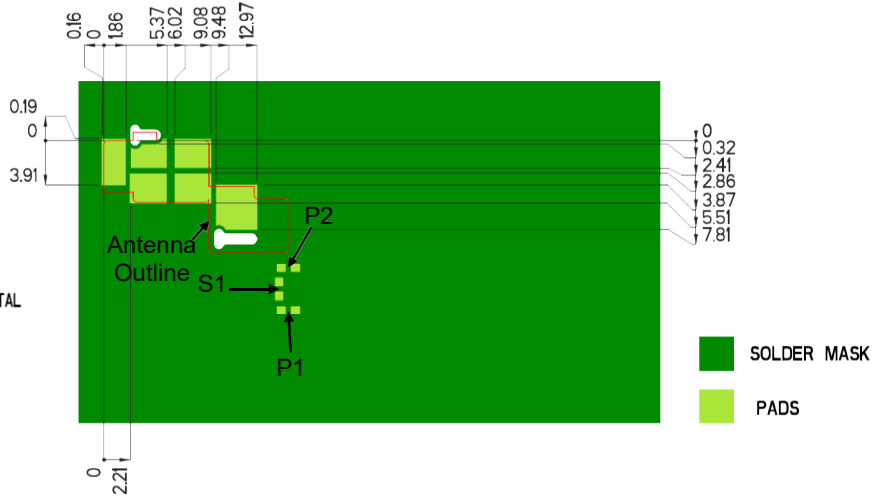
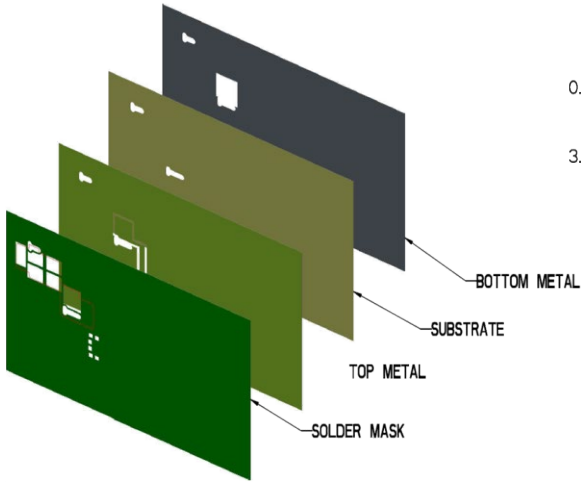

Pin Descriptions

Pin#	Description
1	Feed
2	Ground

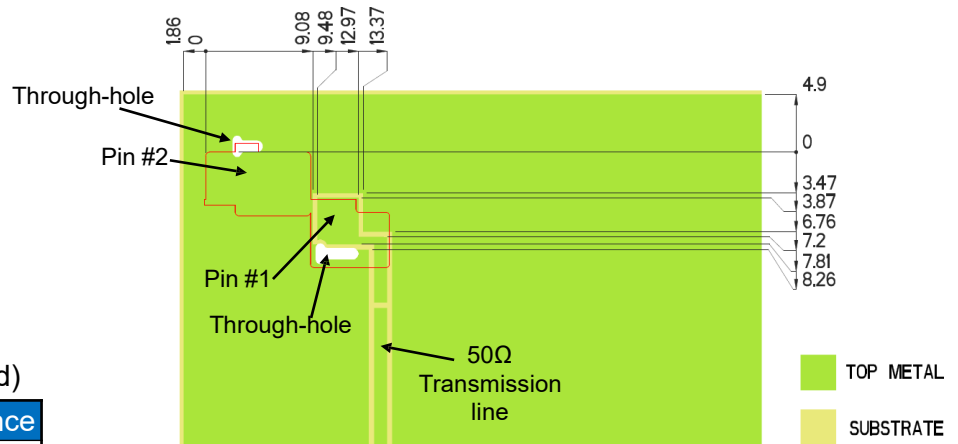

Matching Pi Network (Demo Board)

Component	Value	Tolerance
P1	0.5pF	±0.05pF
S1	1nH	±0.1nH
P2	DNI	DNI

*Actual matching values depend on customer design

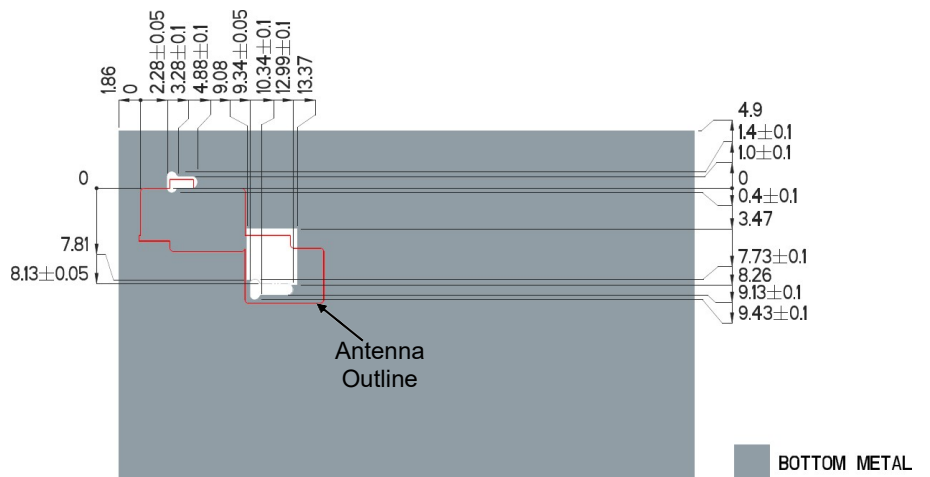
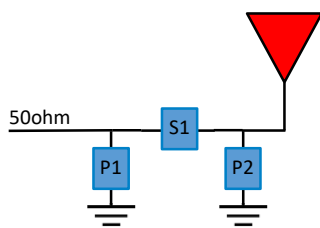

2.4 GHz Stamped Metal KYOCERA AVX Embedded Antenna Specifications
KYOCERA AVX produces a wide variety of standard and custom antennas to meet user needs.

Antenna Layout cont. (SMT Mounting, Through-hole for Stabilization)

Typical layout dimensions (mm)

Exploded View

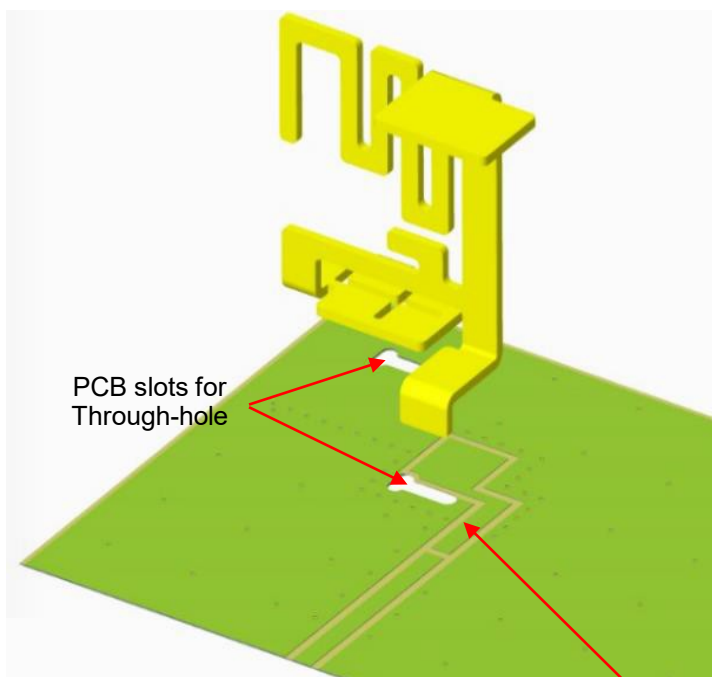

Assembled View

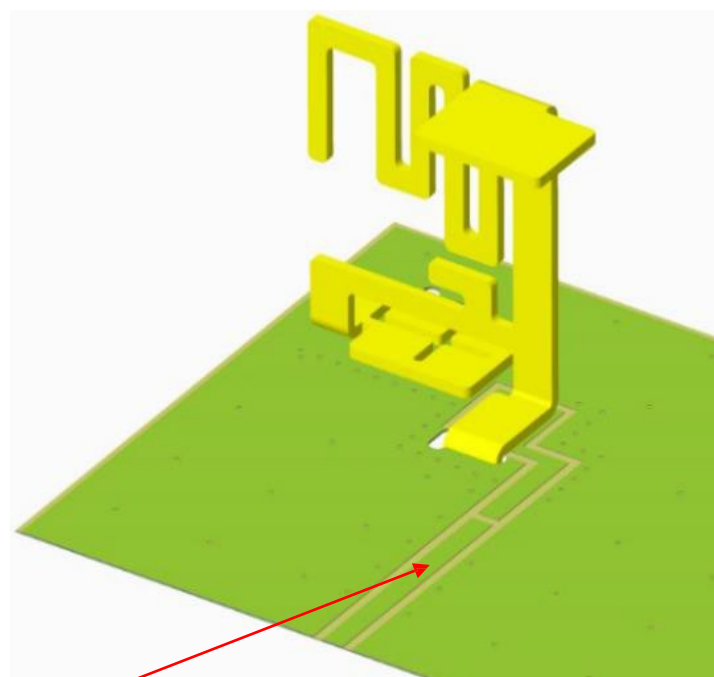

A 50 ohm transmission line needs to be designed and connected at this location

Bottom View



2.4 GHz Stamped Metal KYOCERA AVX Embedded Antenna Specifications
 KYOCERA AVX produces a wide variety of standard and custom antennas to meet user needs.

Antenna Demo Board

Typical layout dimensions (mm)

Part Number	A (mm)	B (mm)	C (mm)	D (mm)
1000366-01	75.0	75.0	4.9	1.86

