



REV. A, Apr, 2013

## FEATURES

- \* Very high power TS AlGaAs technology
- \* T-1 3/4 Package
- \* 875 nm Wavelength
- \* very high intensity:  
HSDL-4220 :38MW/SR ; 30 degree
- \*Low forward voltage for series operation
- \*Applications
- \*IR Audio
- \*IR Telephones
- \*High speed: 40ns Rise times
- \*High Speed IR communications
- IR LANS
- IR Modems
- IR Dongles
- \*Industrial IR Equipment
- \*IR Portable Instruments

## PACKAGE DIMENSIONS

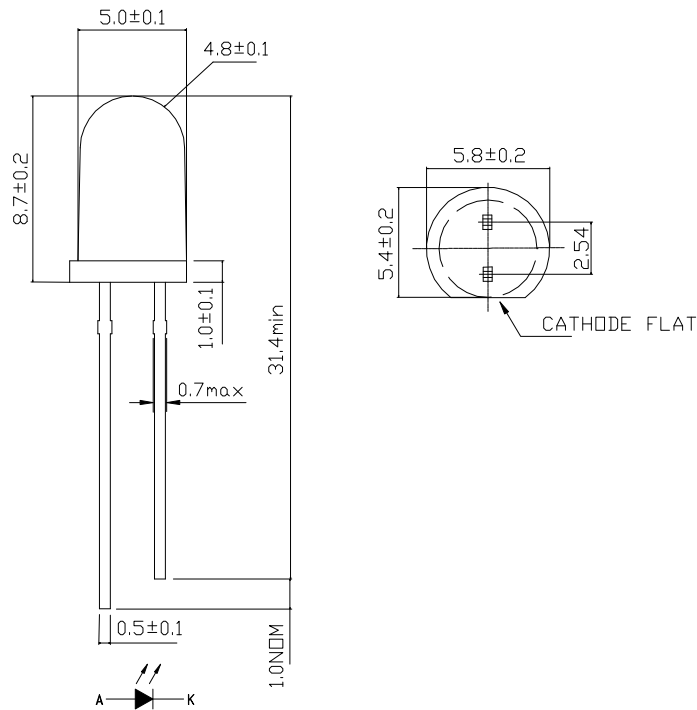

### NOTES:

1. All dimensions are in millimeters (inches).
2. Tolerance is ±0.25mm(.010") unless otherwise noted.
3. Protruded resin under flange is 1.5mm(.059") max.
4. Lead spacing is measured where the leads emerge from the package.
5. Specifications are subject to change without notice.



# LITE-ON TECHNOLOGY CORPORATION.

Property of Lite-On Only

## ABSOLUTE MAXIMUM RATINGS AT TA=25°C

PARAMETER	Symbol	MIN	MAX	UNIT	Reference
Average Forward Current	I <sub>FAVG</sub>		100	mA	[2]
Peak Forward Current	I <sub>FPK</sub>		500	mA	[2].Fig.2b Duty Factor=20% Pulse Width=100uA
DC Forward Current	I <sub>FDC</sub>		100	mA	[1].Fig.2a
Power Dissipation	P <sub>DISS</sub>		260	mW	
Reverse Voltage (IR=100uA)	V <sub>R</sub>	5		V	
Transient Forward Current (10us Pulse)	I <sub>FTR</sub>		1.0	A	[3]
Operating Temperature	T <sub>O</sub>	0	70	°C	
Storage Temperature	T <sub>S</sub>	-20	85	°C	
LED Junction Temperature	T <sub>J</sub>		110	°C	
Lead Soldering Temperature [1.6mm(.063") From Body]			260 for 5 seconds	°C	

### Notes:

1. Derate linearly as show in Figure 4.
2. Any pulse operation cannot exceed the absolute Max Peak Forward current as Specified in Figure 5.
3. The transient Peak current is the maximum non-recurring the LED die and the wire bonds.



# LITE-ON TECHNOLOGY CORPORATION.

Property of Lite-On Only

## ELECTRICAL OPTICAL CHARACTERISTICS AT TA=25°C

PARAMETER	Symbol	MIN.	TYP.	MAX.	UNIT	TEST CONDITION	Reference
Forward Voltage	V <sub>F</sub>	1.3	1.5	1.7	V	I <sub>FDC</sub> = 50mA	Fig.2a
			2.15		V	I <sub>FPK</sub> = 250mA	Fig.2b
Forward Voltage Temperature Coefficient	$\Delta V / \Delta T$		-2.1		mV/°C	I <sub>FDC</sub> = 50mA	Fig.2C
			-2.1			I <sub>FDC</sub> = 100mA	
Series Resistance	R <sub>S</sub>		2.8		ohms	I <sub>FDC</sub> = 100mA	
Diode Capacitance	C <sub>O</sub>		40		pF	0V, 1M Hz	
Reverse Voltage	V <sub>R</sub>	2	20		V	I <sub>R</sub> = 100 $\mu$ A	
Thermal Resistance, Junction to Pin	R $\theta$ JP		110		°C/W		



# LITE-ON TECHNOLOGY CORPORATION.

Property of Lite-On Only

## OPTICAL CHARACTERISTICS AT TA=25°C

PARAMETER	Symbol	MIN.	TYP.	MAX.	UNIT	Test condition	Reference
Radiant Optical Power	Po		19		mW	IFDC = 50mA	
			38		mW	IFPK = 100mA	
Radiant On-Axis Intensity	IE	22	38	60	Mw/Sr	IFDC = 50mA	Fig.3a
			76		Mw/Sr	IFDC = 100mA	
			190		Mw/Sr	IFDC = 250mA	Fig.3b
Radiant On-Axis Intensity Temperature Coefficient	$\Delta I_E / \Delta T$		-0.35 -0.35		%/°C	IFDC = 50mA IFDC = 100mA	
Viewing Angle	$2\theta_{1/2}$		30		deg	IFDC = 50mA	Fig.6
Peak Wavelength	$\lambda_{pk}$	860	875	895	nm	IFDC = 50mA	Fig.1
Peak Wavelength Temperature Coefficient	$\Delta \lambda / \Delta T$		0.25		nm/°C	IFDC = 50mA	
Spectral Width-at FWHM	$\Delta \lambda$		37		nm	IFDC = 50mA	Fig.1
Optical Rise and all Times, 10%-90%	Tr/ Tf		40		ns	IFDC = 50mA	
Bandwidth	fc		9		MHz	IFDC = 50mA $\pm 10mA$	Fig.8

### Ordering Information

Part Number	Lead Form	Shipping Option
HSDL-4220	Straight	Bulk

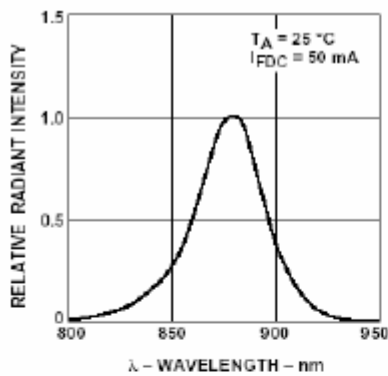

Figure 1. Relative Radiant Intensity vs. Wavelength.

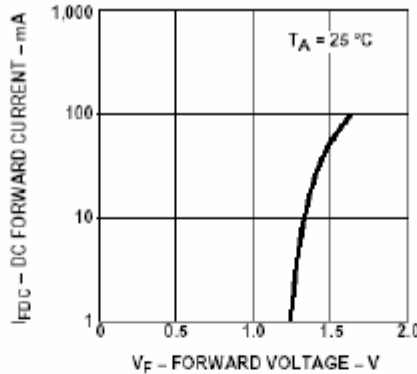

Figure 2a. DC Forward Current vs. Forward Voltage.

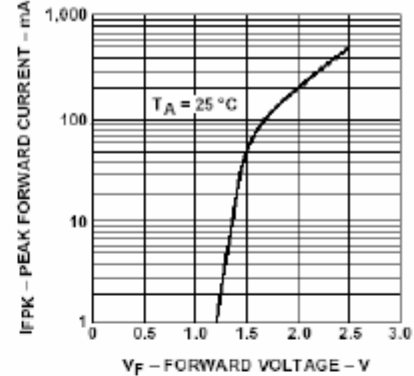

Figure 2b. Peak Forward Current vs. Forward Voltage.

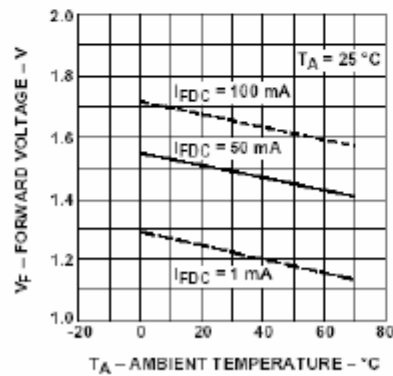

Figure 2c. Forward Voltage vs. Ambient Temperature.

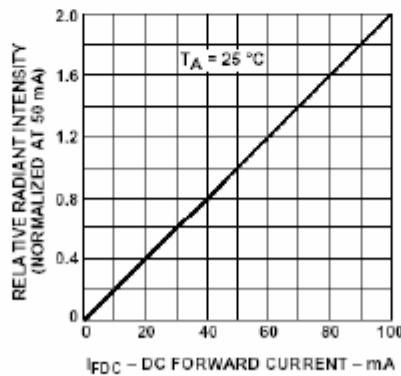

Figure 3a. Relative Radiant Intensity vs. DC Forward Current.

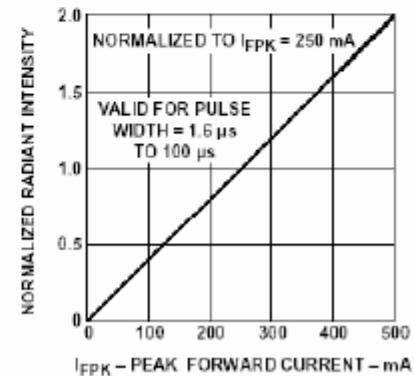

Figure 3b. Normalized Radiant Intensity vs. Peak Forward Current.

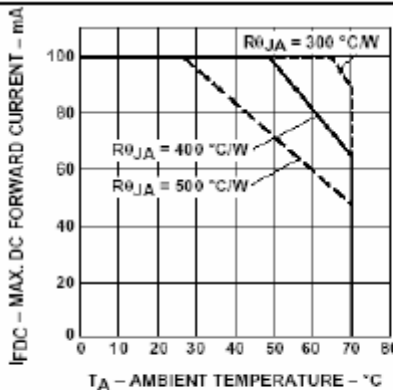

Figure 4. Maximum DC Forward Current vs. Ambient Temperature. Derated Based on  $T_{JMAX} = 110^{\circ}C$ .

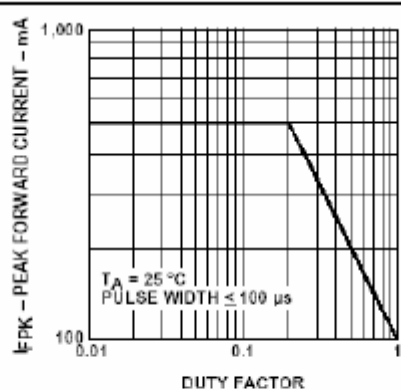

Figure 5. Maximum Peak Forward Current vs. Duty Factor.

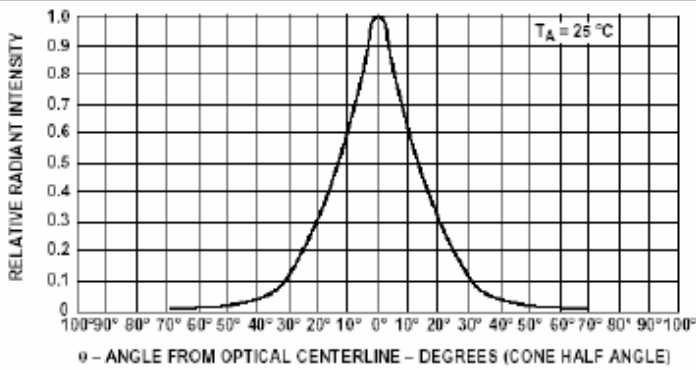

Figure 6. Relative Radiant Intensity vs. Angular Displacement HSDL-4220.

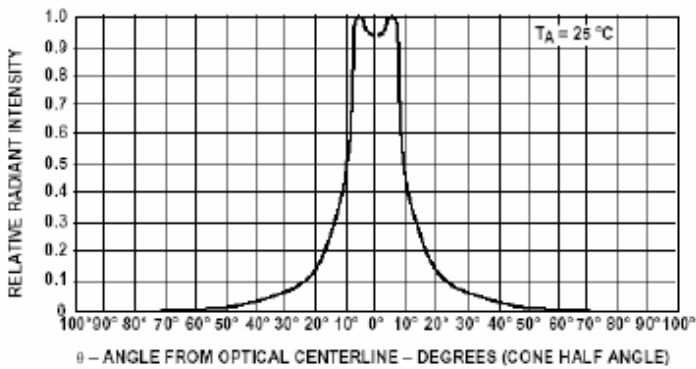

Figure 7. Relative Radiant Intensity vs. Angular Displacement HSDL-4230.

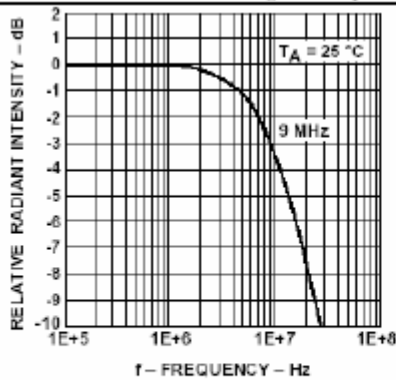

Figure 8. Relative Radiant Intensity vs. Frequency.