

ANT-418-WRT-ccc 418 MHz External Panel-Mount Antenna

The ANT-418-WRT is a low-profile, panel-mount dipole antenna designed for 418 MHz applications.

The ANT-418-WRT antenna's compact size allows it to be mounted in applications requiring a low profile and external antenna performance.

The ANT-418-WRT antenna is designed with an integrated counterpoise that eliminates the need for additional ground plane in the product, making it ideal for applications with non-conductive or RF transparent enclosures.

Connector options for the ANT-418-WRT antenna are: SMA plug (male pin), RP-SMA plug (female socket) or MHF1/U.FL-type plug (female socket).



ANT-418-WRT-SMA Shown

Features

- Performance at 410 MHz to 427 MHz
 - VSWR: ≤ 2.5
 - Peak Gain: -0.5 dBi
 - Efficiency: 31%
- Low-profile
 - Height: 27.0 mm (1.10 in)
 - Diameter: 19.0 mm (0.75 in)
- Mounts permanently with pressure sensitive adhesive ring and provided nut

Applications

- Remote control, sensing and monitoring
 - Security systems
 - Industrial machinery
 - Automated equipment
 - AMR (automated meter reading)
- Internet of Things (IoT) devices
- Smart Home networking

Ordering Information

Part Number	Description
ANT-418-WRT-RPS	Antenna, 216 mm (8.50 in) of RG-174 coaxial cable, RP-SMA plug (female socket)
ANT-418-WRT-SMA	Antenna, 216 mm (8.50 in) of RG-174 coaxial cable, SMA plug (male pin)
ANT-418-WRT-UFL	Antenna, 216 mm (8.50 in) of 1.32 mm coaxial cable, MHF1/U.FL-type plug (female socket)

Available from Linx Technologies and select distributors and representatives.

Table 1. Electrical Specifications

ANT-418-WRT	418 MHz		
Frequency Range	410 MHz to 427 MHz		
VSWR (max)	2.5		
Peak Gain (dBi)	-0.5		
Average Gain (dBi)	-5.3		
Efficiency (%)	31		
Polarization	Linear	Radiation	Omnidirectional
Impedance	50 Ω	Max Power	5 W
Wavelength	1/2-wave	Electrical Type	Dipole

Electrical specifications and plots measured with a 102 mm x 102 mm (4.0 in x 4.0 in) reference ground plane.

Table 2. Mechanical Specifications

Part Number	Connection	Coaxial Cable, minimum inside bend radius	Weight
ANT-418-WRT-UFL	MHF1/U.FL-type plug	1.32 mm: 6.0 mm (0.24 in)	216 mm = 9.4 g (0.33 oz)
ANT-418-WRT-RPS	RP-SMA plug	1.32 mm: 6.0 mm (0.24 in)	216 mm = 14.4 g (0.51 oz)
ANT-418-WRT-SMA	SMA plug	0.81 mm: 4.0 mm (0.16 in)	216 mm = 14.4 g (0.51 oz)
Operating Temp. Range	-40 °C to +90 °C		
Dimensions	Height: 10.0 mm (0.40 in), Diameter: 19.0 mm (0.75 in)		

Packaging Information

The ANT-418-WRT antenna is placed in a clear plastic sleeve and sealed in clear plastic bags in quantities of 50 pcs. Bags are packaged in cartons of 250 (5 bags). Distribution channels may offer alternative packaging options.

Product Dimensions

Figure 1 provides dimensions for the ANT-418-WRT series antenna.

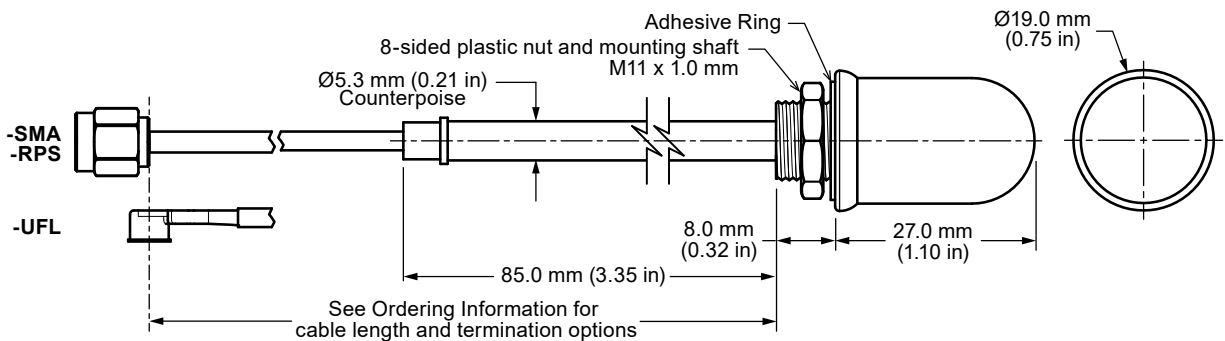

Figure 1. ANT-418-WRT Antenna Dimensions

Recommended Mounting

The recommended enclosure mounting dimensions are shown in Figure 2. The ANT-418-WRT series antenna is supplied with an integrated closed-cell pressure sensitive adhesive ring which helps seal enclosures against external elements. The adhesive ring has a protective plastic backing that must be removed prior to installation. A pull tab has been provided for easy removal of the protective backing. The antenna can be permanently mounted using the provided nut which should be tightened to 4.0 kgf/cm (5 in/lbs) max. The recommended maximum enclosure wall thickness is 4.70 mm (0.188 in).

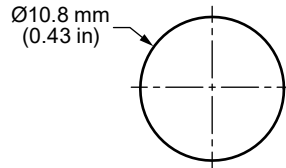

Figure 2. ANT-418-WRT Series Antenna Recommended Enclosure Mounting Dimensions

Antenna Orientation

The ANT-418-WRT antenna is characterized in two antenna orientations as shown in Figure 3. The antenna in free space characterizes use of an antenna attached to an enclosure-mounted connector which is connected by cable to a printed circuit board. Although the antenna is a dipole not requiring a ground plane for function, characterization with an adjacent ground plane (102 mm x 102 mm) provides insight into antenna performance when attached directly to a printed circuit board mounted connector. The two orientations represent the most common end-product use cases.

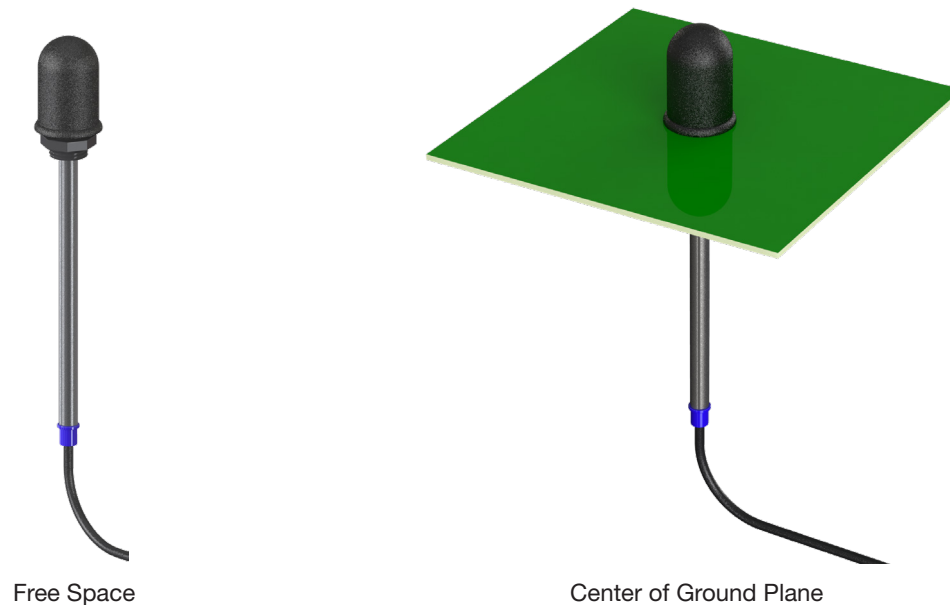

Figure 3. ANT-418-WRT Test Orientations

Free Space, No Ground Plane

The charts on the following pages represent data taken with the antenna oriented in free space without a ground plane, as shown in Figure 4.



Figure 4. ANT-418-WRT in Free Space, No Ground Plane

VSWR

Figure 5 provides the voltage standing wave ratio (VSWR) across the antenna bandwidth. VSWR describes the power reflected from the antenna back to the radio. A lower VSWR value indicates better antenna performance at a given frequency. Reflected power is also shown on the right-side vertical axis as a gauge of the percentage of transmitter power reflected back from the antenna.

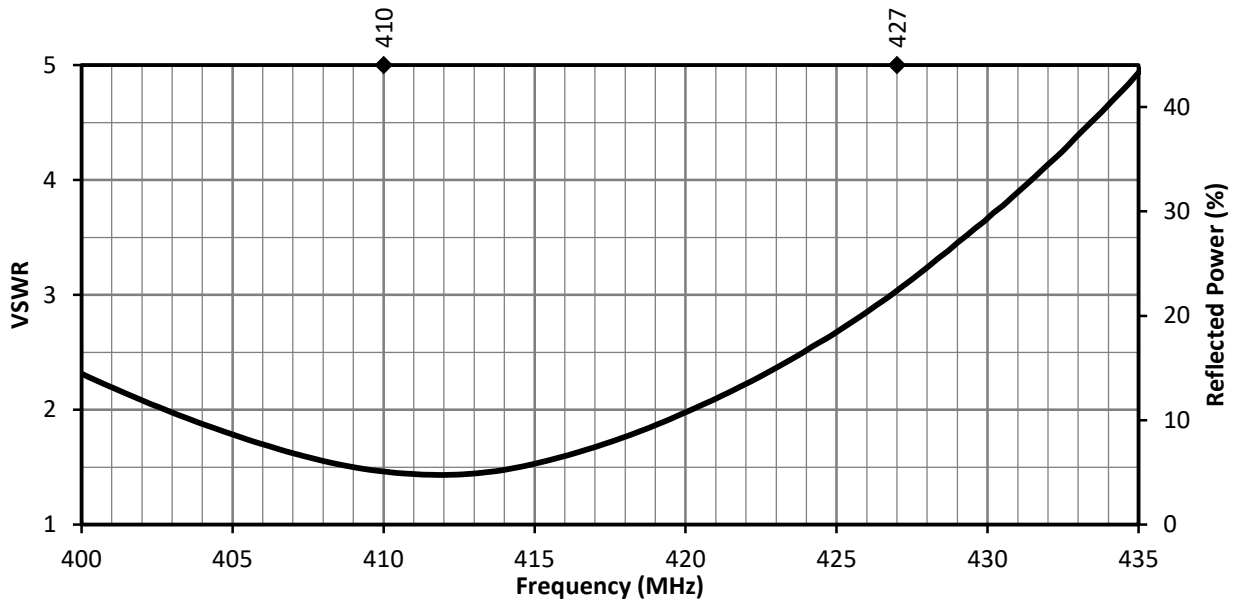

Figure 5. ANT-418-WRT VSWR, Free Space

Return Loss

Return loss (Figure 6), represents the loss in power at the antenna due to reflected signals. Like VSWR, a lower return loss value indicates better antenna performance at a given frequency.

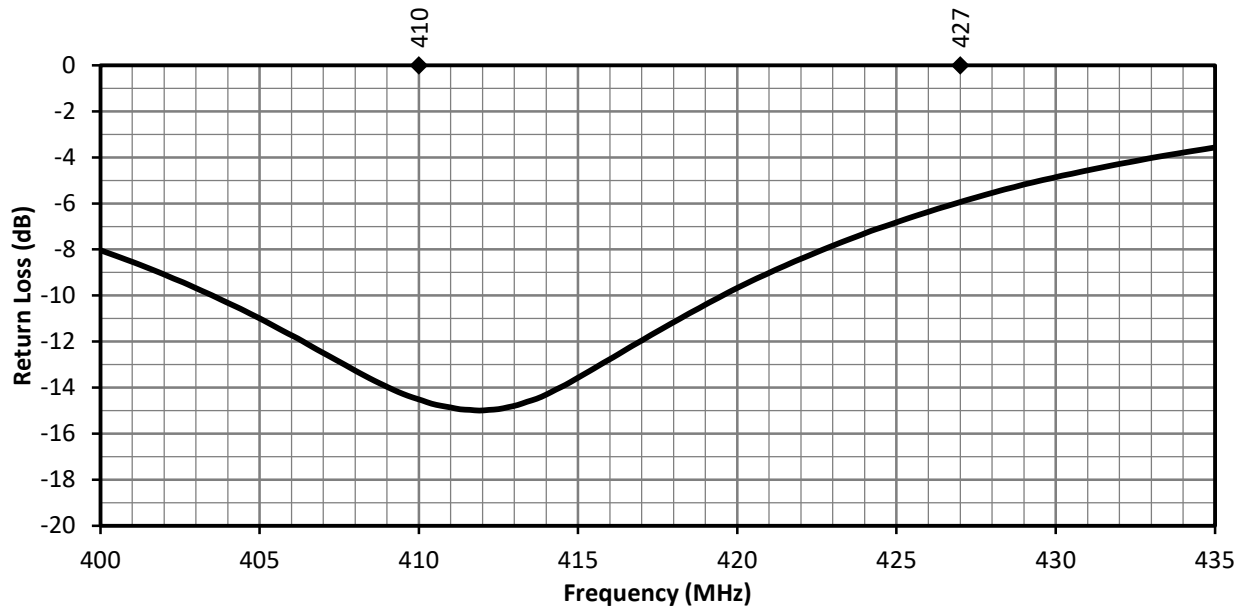

Figure 6. ANT-418-WRT Return Loss, Free Space

Peak Gain

The peak gain across the antenna bandwidth is shown in Figure 7. Peak gain represents the maximum antenna input power concentration across 3-dimensional space, and therefore peak performance at a given frequency, but does not consider any directionality in the gain pattern.

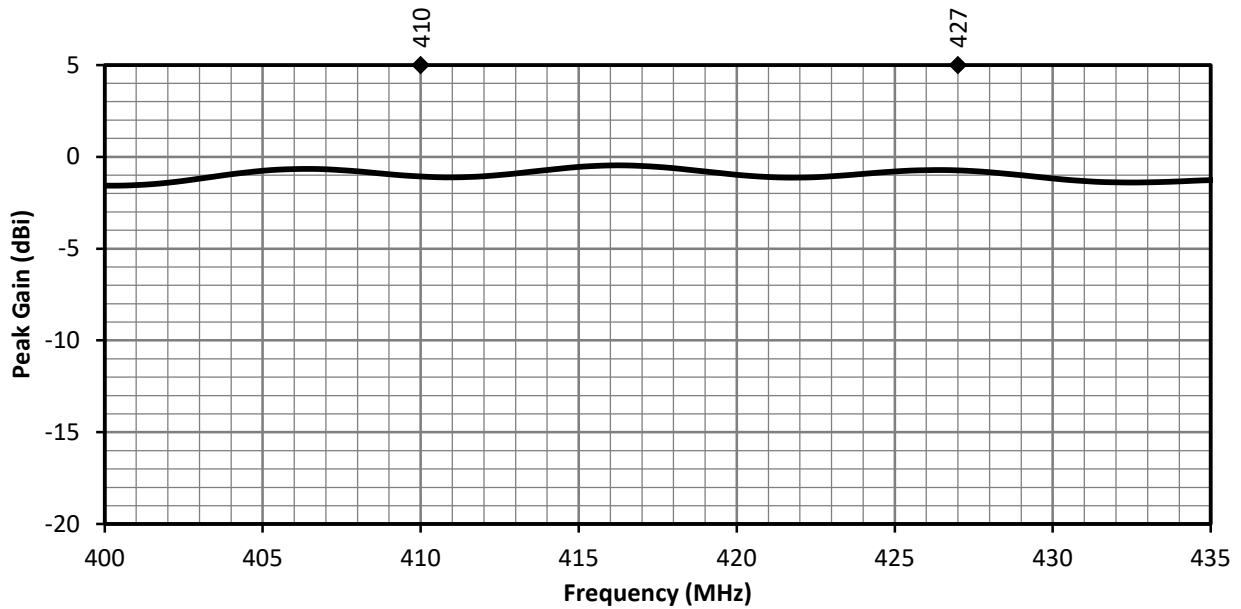

Figure 7. ANT-418-WRT Peak Gain, Free Space

Average Gain

Average gain (Figure 8), is the average of all antenna gain in 3-dimensional space at each frequency, providing an indication of overall performance without expressing antenna directionality.

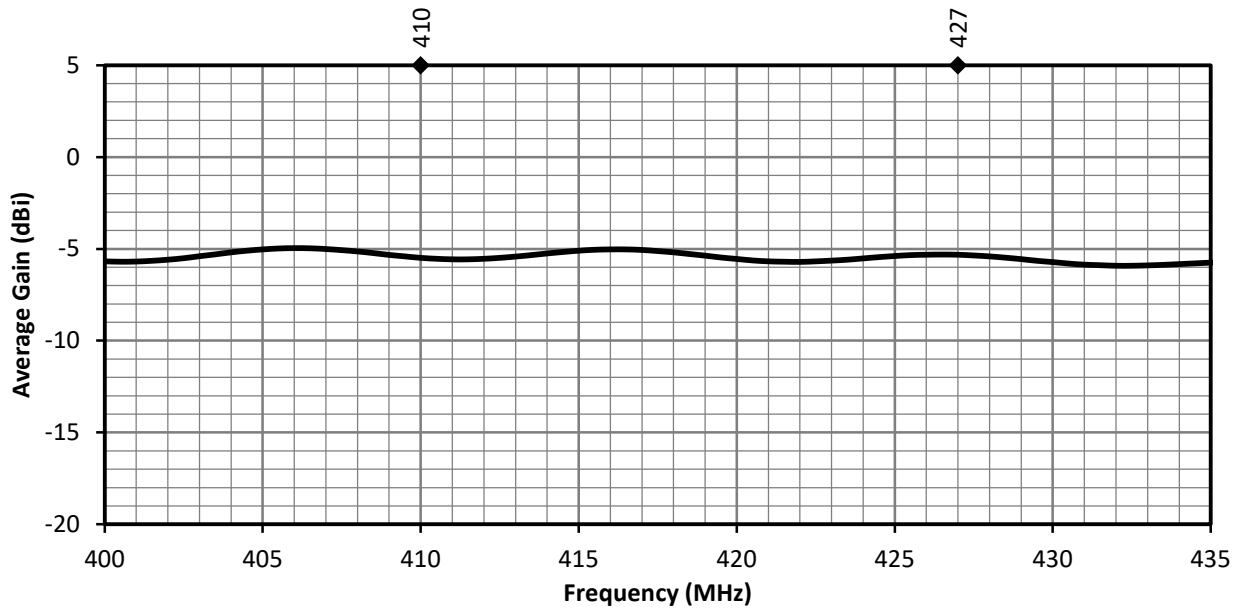

Figure 8. ANT-418-WRT Antenna Average Gain, Free Space

Radiation Efficiency

Radiation efficiency (Figure 9), shows the ratio of power delivered to the antenna relative to the power radiated at the antenna, expressed as a percentage, where a higher percentage indicates better performance at a given frequency.

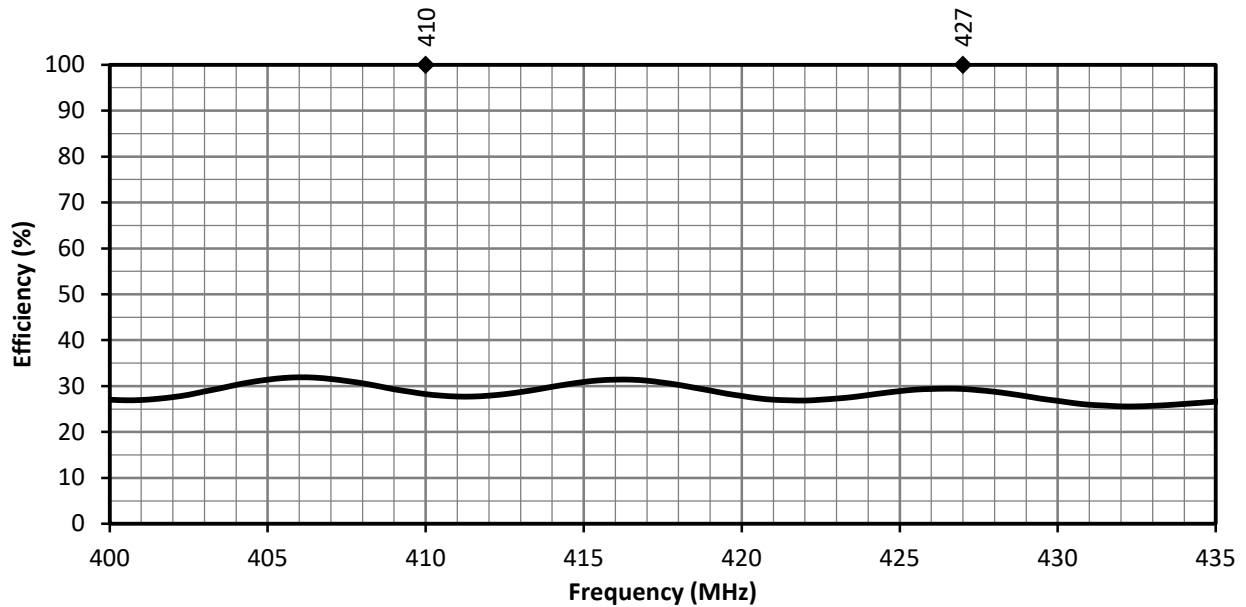

Figure 9. ANT-418-WRT Antenna Radiation Efficiency, Free Space

Radiation Patterns

Radiation patterns provide information about the directionality and 3-dimensional gain performance of the antenna by plotting gain at specific frequencies in three orthogonal planes. Antenna radiation patterns are shown in Figure 10 using polar plots covering 360 degrees. The antenna graphic at the top of the page provides reference to the plane of the column of plots below it. Note: when viewed with typical PDF viewing software, zooming into radiation patterns is possible to reveal fine detail.

Radiation Patterns - Free Space



410 MHz to 427 MHz (418 MHz)

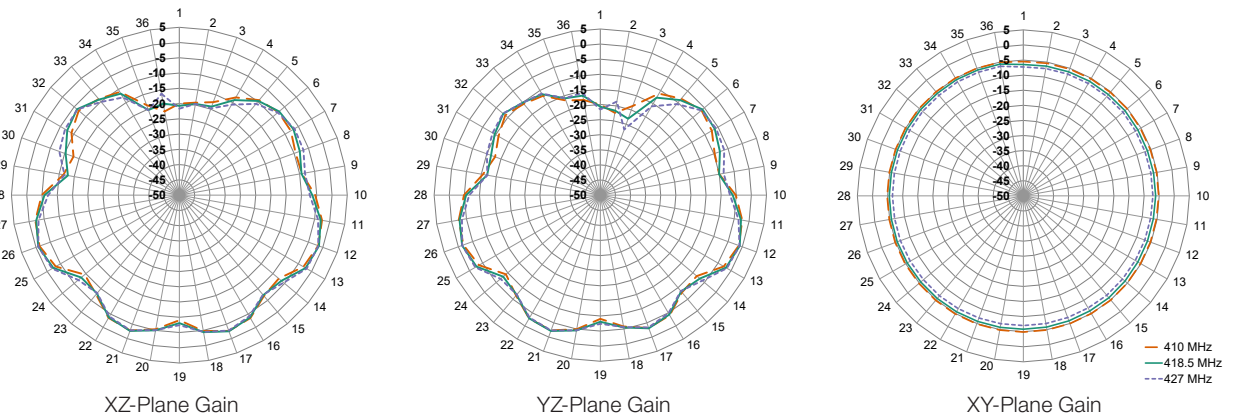

Figure 10. ANT-418-WRT Radiation Patterns, Free Space

Center of Ground Plane

The charts on the following pages represent data taken with the antenna oriented at the center of the ground plane, as shown in Figure 11.

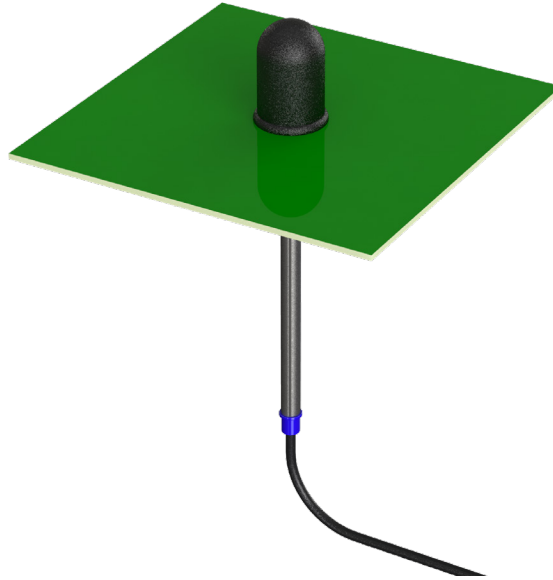

Figure 11. ANT-418-WRT at Center of Ground Plane

VSWR

Figure 12 provides the voltage standing wave ratio (VSWR) across the antenna bandwidth. VSWR describes the power reflected from the antenna back to the radio. A lower VSWR value indicates better antenna performance at a given frequency. Reflected power is also shown on the right-side vertical axis as a gauge of the percentage of transmitter power reflected back from the antenna.

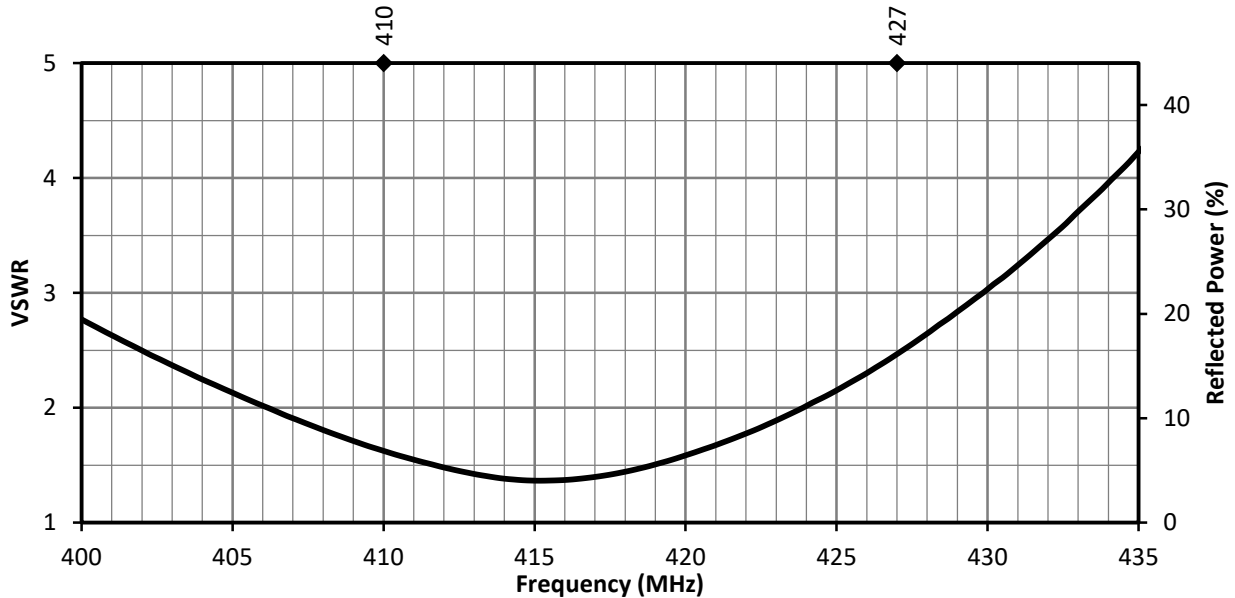

Figure 12. ANT-418-WRT VSWR, at Center of Ground Plane

Return Loss

Return loss (Figure 13), represents the loss in power at the antenna due to reflected signals. Like VSWR, a lower return loss value indicates better antenna performance at a given frequency.

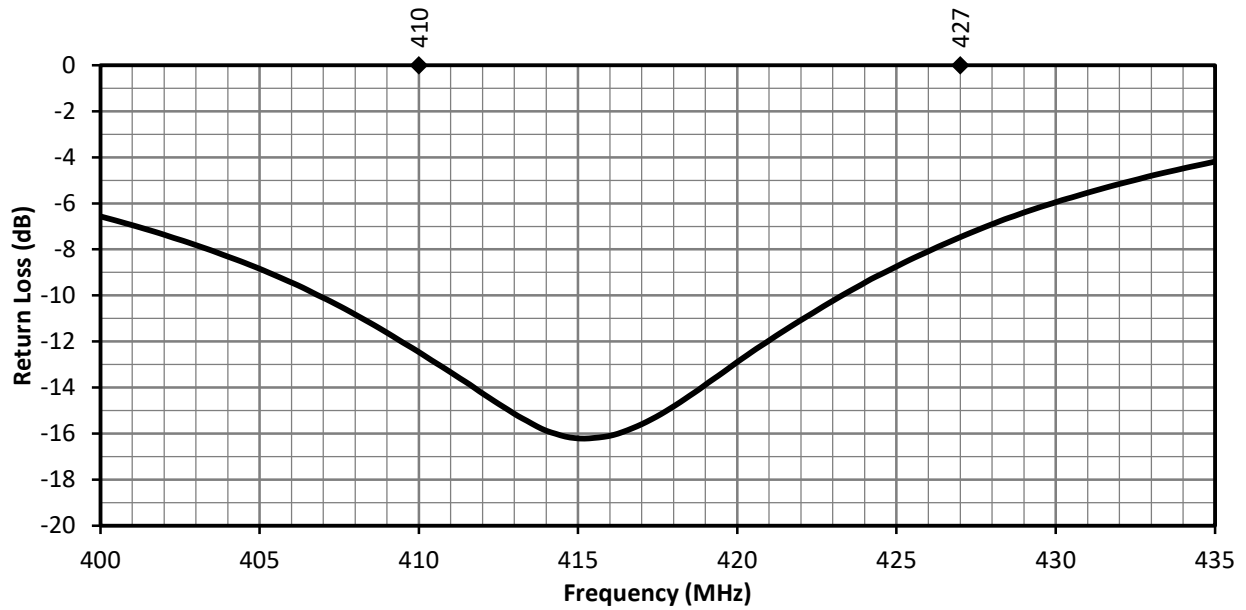

Figure 13. ANT-418-WRT Return Loss, at Center of Ground Plane

Peak Gain

The peak gain across the antenna bandwidth is shown in Figure 14. Peak gain represents the maximum antenna input power concentration across 3-dimensional space, and therefore peak performance at a given frequency, but does not consider any directionality in the gain pattern.

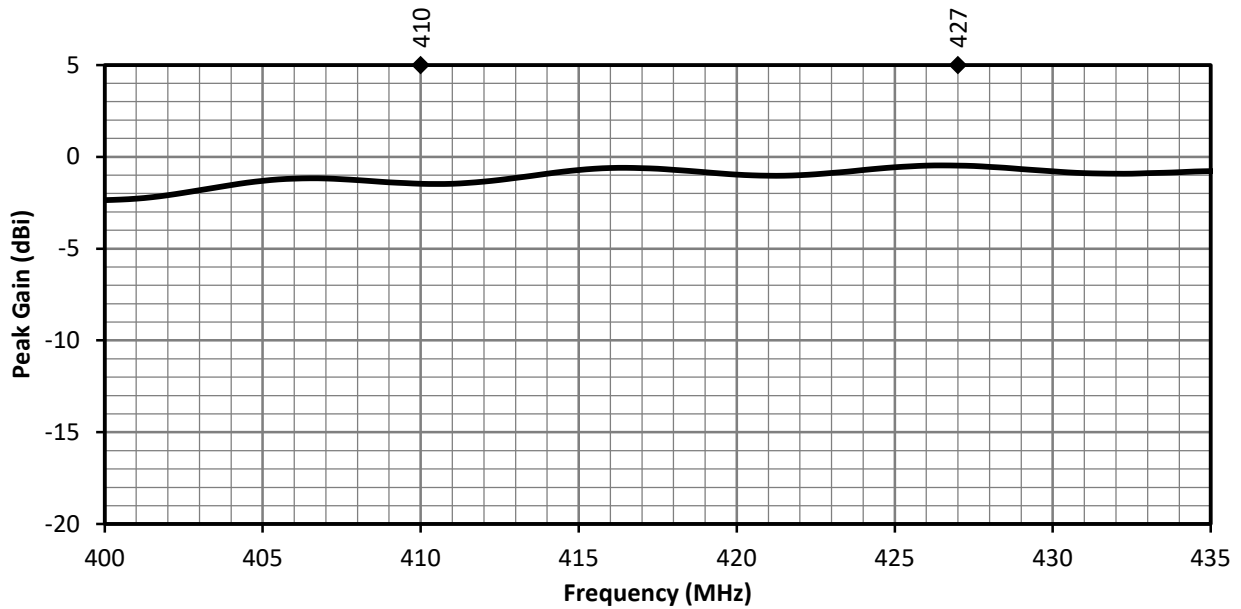

Figure 14. ANT-418-WRT Peak Gain, at Center of Ground Plane

Average Gain

Average gain (Figure 15), is the average of all antenna gain in 3-dimensional space at each frequency, providing an indication of overall performance without expressing antenna directionality.

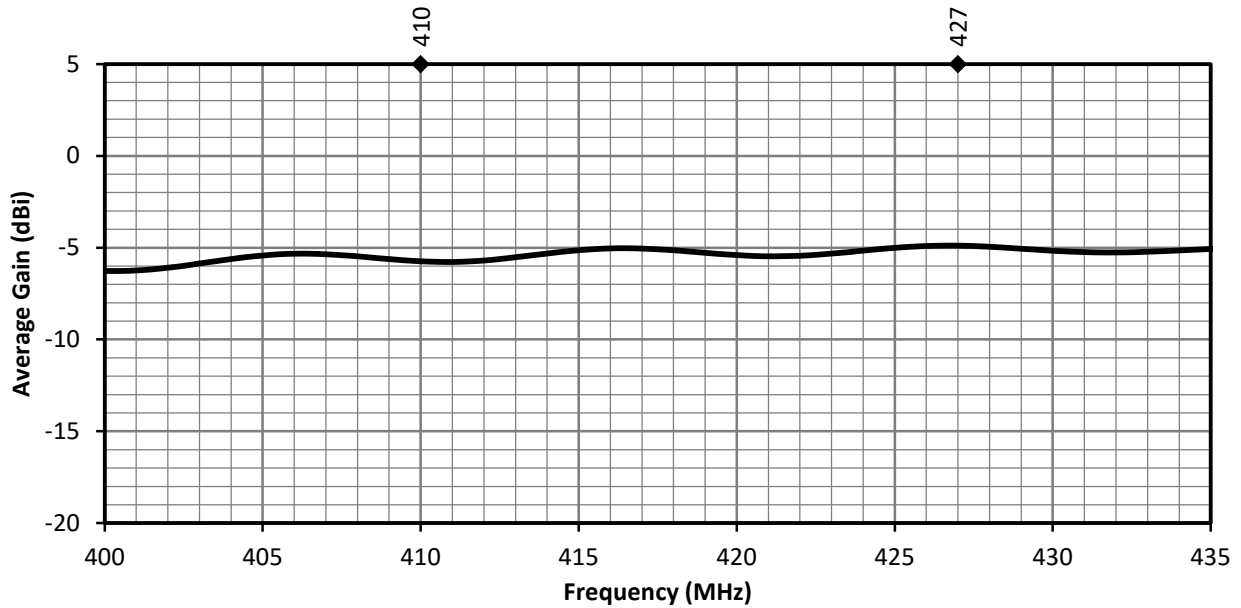

Figure 15. ANT-418-WRT Antenna Average Gain, at Center of Ground Plane

Radiation Efficiency

Radiation efficiency (Figure 16), shows the ratio of power delivered to the antenna relative to the power radiated at the antenna, expressed as a percentage, where a higher percentage indicates better performance at a given frequency.

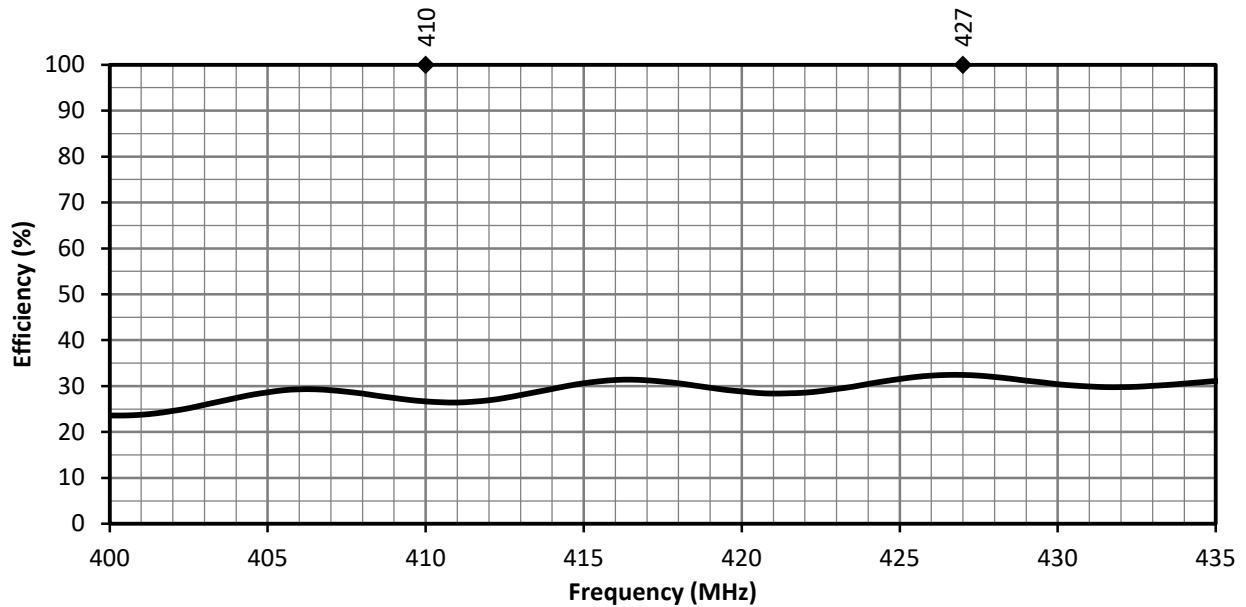
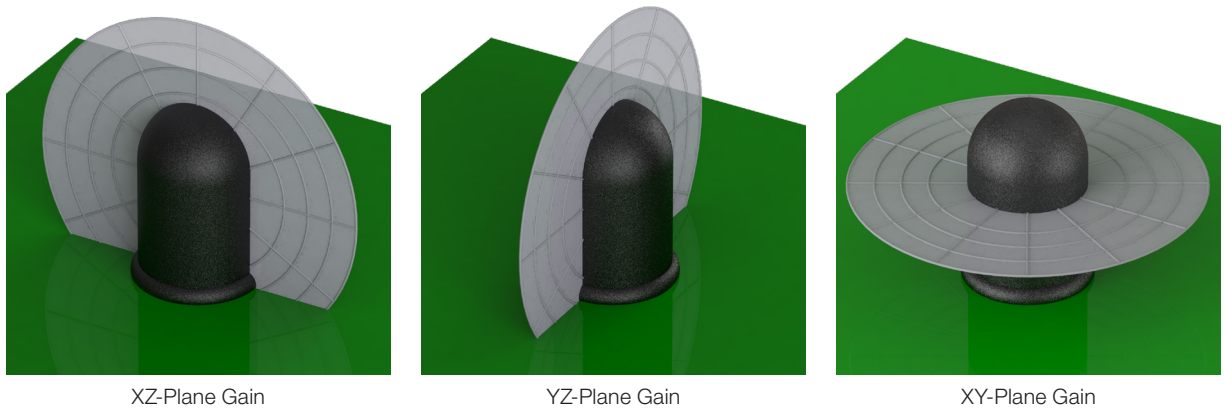

Figure 16. ANT-418-WRT Antenna Radiation Efficiency, at Center of Ground Plane

Radiation Patterns

Radiation patterns provide information about the directionality and 3-dimensional gain performance of the antenna by plotting gain at specific frequencies in three orthogonal planes. Antenna radiation patterns are shown in Figure 17 using polar plots covering 360 degrees. The antenna graphic at the top of the page provides reference to the plane of the column of plots below it. Note: when viewed with typical PDF viewing software, zooming into radiation patterns is possible to reveal fine detail.

Radiation Patterns - Center of Ground Plane



410 MHz to 427 MHz (418 MHz)

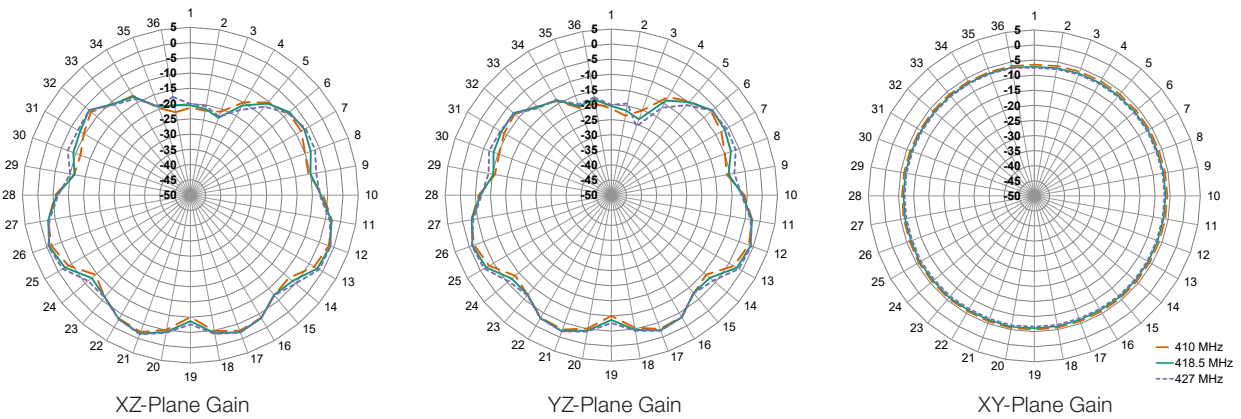

Figure 17. ANT-418-WRT Radiation Patterns, Center of Ground Plane

Website: <http://linxtechnologies.com>
Linx Offices: 159 Ort Lane, Merlin, OR, US 97532
Phone: +1 (541) 471-6256
E-MAIL: info@linxtechnologies.com

Linx Technologies reserves the right to make changes to the product(s) or information contained herein without notice. No liability is assumed as a result of their use or application. No rights under any patent accompany the sale of any such product(s) or information.

Wireless Made Simple is a registered trademark of Linx Acquisitions LLC. Other product and brand names may be trademarks or registered trademarks of their respective owners.

Copyright © 2022 Linx Technologies

All Rights Reserved

Doc# DS22070-202ANT Replaces (DS21347-202ANT)

