



Features

- Logic Level Input
- Input Protection (ESD)
- Thermal shutdown with latch
- Overload protection
- Short circuit protection
- Overvoltage protection
- Current limitation
- Status feedback with external input resistor
- Analog driving possible
- AEC qualified
- Green product (RoHS compliant)

Product Summary

Drain source voltage	V_{DS}	60	V
On-state resistance	$R_{DS(on)}$	28	m Ω
Current limit	$I_{D(lim)}$	25	A
Nominal load current	$I_{D(ISO)}$	12	A
Clamping energy	E_{AS}	4000	mJ

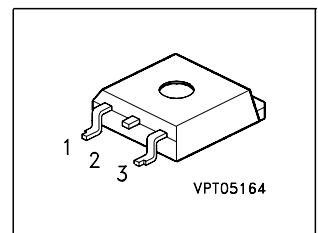

Application

- All kinds of resistive, inductive and capacitive loads in switching or linear applications
- μ C compatible power switch for 12 V and 24 V DC applications
- Replaces electromechanical relays and discrete circuits

General Description

N channel vertical power FET in Smart SIPMOS[®] chip on chip technology. Providing embedded protection functions.

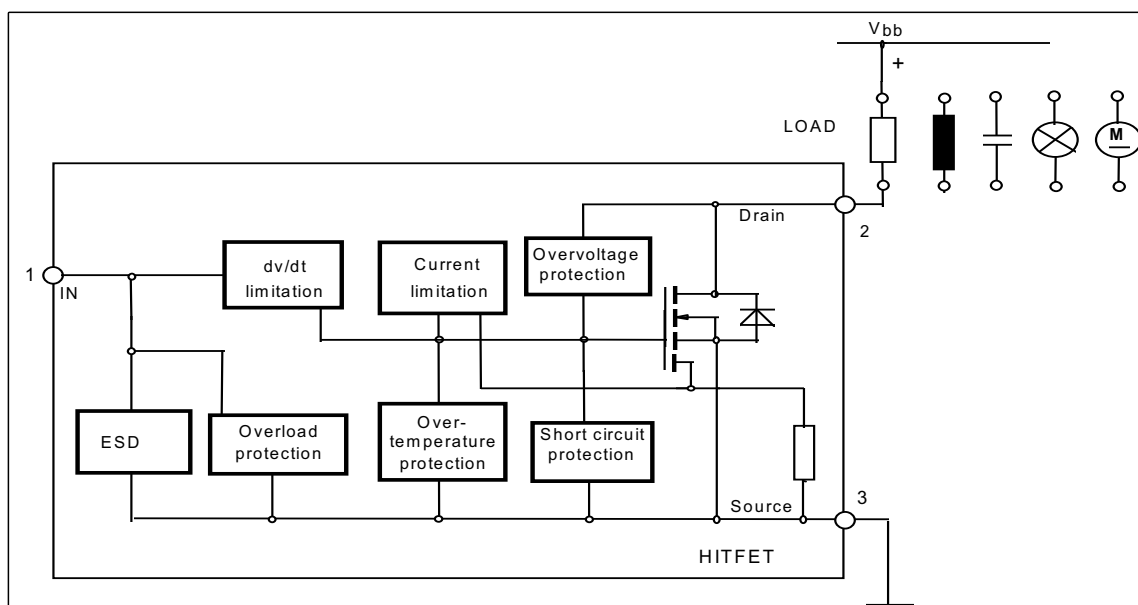

Maximum Ratings at $T_j = 25\text{ °C}$ unless otherwise specified

Parameter	Symbol	Value	Unit
Drain source voltage	V_{DS}	60	V
Drain source voltage for short circuit protection	$V_{DS(SC)}$	32	
Continuous input current ¹⁾ $-0.2V \leq V_{IN} \leq 10V$ $V_{IN} < -0.2V$ or $V_{IN} > 10V$	I_{IN}	no limit $ I_{IN} \leq 2$	mA
Operating temperature	T_j	- 40 ... +150	°C
Storage temperature	T_{stg}	- 55 ... +150	
Power dissipation $T_C = 25\text{ °C}$	P_{tot}	149	W
Unclamped single pulse inductive energy $I_{D(ISO)} = 12\text{ A}$	E_{AS}	4000	mJ
Electrostatic discharge voltage (Human Body Model) according to MIL STD 883D, method 3015.7 and EOS/ESD assn. standard S5.1 - 1993	V_{ESD}	3000	V
Load dump protection $V_{LoadDump}^{2)} = V_A + V_S$ $V_{IN} = \text{low or high}; V_A = 13.5\text{ V}$ $t_d = 400\text{ ms}, R_l = 2\ \Omega, I_D = 0,5 \cdot 12\text{ A}$ $t_d = 400\text{ ms}, R_l = 2\ \Omega, I_D = 12\text{ A}$	V_{LD}	100 84	

Thermal resistance

junction - case:	R_{thJC}	0.84	K/W
junction - ambient:	R_{thJA}	75	
SMD version, device on PCB: ³⁾	R_{thJA}	45	

¹⁾ In case of thermal shutdown a minimum sensor holding current of 500 μA has to be guaranteed (see also page 3).

²⁾ $V_{LoadDump}$ is setup without the DUT connected to the generator per ISO 7637-1 and DIN 40839

³⁾ Device on 50mm*50mm*1.5mm epoxy PCB FR4 with 6cm² (one layer, 70 μm thick) copper area for Drain connection. PCB mounted vertical without blown air.

Electrical Characteristics

Parameter at $T_j=25^\circ\text{C}$, unless otherwise specified	Symbol	Values			Unit
		min.	typ.	max.	
Characteristics					
Drain source clamp voltage $T_j = -40 \dots +150^\circ\text{C}$, $I_D = 10 \text{ mA}$	$V_{DS(AZ)}$	60	-	73	V
Off state drain current $V_{DS} = 32 \text{ V}$, $T_j = -40\dots+150^\circ\text{C}$, $V_{IN} = 0 \text{ V}$	I_{DSS}	-	-	20	μA
Input threshold voltage $I_D = 2,7 \text{ mA}$	$V_{IN(th)}$	1.3	1.7	2.2	V
Input current - normal operation, $I_D < I_{D(lim)}$: $V_{IN} = 10 \text{ V}$	$I_{IN(1)}$	-	35	100	μA
Input current - current limitation mode, $I_D = I_{D(lim)}$: $V_{IN} = 10 \text{ V}$	$I_{IN(2)}$	-	270	500	
Input current - after thermal shutdown, $I_D = 0 \text{ A}$: $V_{IN} = 10 \text{ V}$	$I_{IN(3)}$	1000	2500	4000	
Input holding current after thermal shutdown ¹⁾ $T_j = 25^\circ\text{C}$ $T_j = 150^\circ\text{C}$	$I_{IN(H)}$	500 300	- -	- -	
On-state resistance $V_{IN} = 5 \text{ V}$, $I_D = 12 \text{ A}$, $T_j = 25^\circ\text{C}$ $V_{IN} = 5 \text{ V}$, $I_D = 12 \text{ A}$, $T_j = 150^\circ\text{C}$	$R_{DS(on)}$	- -	31 52	34 68	$\text{m}\Omega$
On-state resistance $V_{IN} = 10 \text{ V}$, $I_D = 12 \text{ A}$, $T_j = 25^\circ\text{C}$ $V_{IN} = 10 \text{ V}$, $I_D = 12 \text{ A}$, $T_j = 150^\circ\text{C}$	$R_{DS(on)}$	- -	25 45	28 56	
Nominal load current (ISO 10483) $V_{IN} = 10 \text{ V}$, $V_{DS} = 0.5 \text{ V}$, $T_C = 85^\circ\text{C}$	$I_{D(ISO)}$	12	-	-	A

¹⁾If the input current is limited by external components, low drain currents can flow and heat the device.
Auto restart behaviour can occur.

Electrical Characteristics

Parameter at $T_j=25^\circ\text{C}$, unless otherwise specified	Symbol	Values			Unit
		min.	typ.	max.	

Characteristics

Initial peak short circuit current limit $V_{IN} = 10\text{ V}$, $V_{DS} = 12\text{ V}$	$I_{D(SCp)}$	-	100	-	A
Current limit ¹⁾ $V_{IN} = 10\text{ V}$, $V_{DS} = 12\text{ V}$, $t_m = 350\ \mu\text{s}$, $T_j = -40\dots+150\ ^\circ\text{C}$	$I_{D(lim)}$	25	35	50	

Dynamic Characteristics

Turn-on time V_{IN} to 90% I_D : $R_L = 2,2\ \Omega$, $V_{IN} = 0$ to 10 V , $V_{bb} = 12\text{ V}$	t_{on}	-	40	100	μs
Turn-off time V_{IN} to 10% I_D : $R_L = 2,2\ \Omega$, $V_{IN} = 10$ to 0 V , $V_{bb} = 12\text{ V}$	t_{off}	-	70	170	
Slew rate on 70 to 50% V_{bb} : $R_L = 2,2\ \Omega$, $V_{IN} = 0$ to 10 V , $V_{bb} = 12\text{ V}$	$-dV_{DS}/dt_{on}$	-	1	3	$\text{V}/\mu\text{s}$
Slew rate off 50 to 70% V_{bb} : $R_L = 2,2\ \Omega$, $V_{IN} = 10$ to 0 V , $V_{bb} = 12\text{ V}$	dV_{DS}/dt_{off}	-	1	3	

Protection Functions ²⁾

Thermal overload trip temperature	T_{jt}	150	165	-	$^\circ\text{C}$
Unclamped single pulse inductive energy $I_D = 12\text{ A}$, $T_j = 25\ ^\circ\text{C}$, $V_{bb} = 32\text{ V}$ $I_D = 12\text{ A}$, $T_j = 150\ ^\circ\text{C}$, $V_{bb} = 32\text{ V}$	E_{AS}	4000 900	- -	- -	mJ

Inverse Diode

Inverse diode forward voltage $I_F = 5*12\text{ A}$, $t_m = 300\ \mu\text{s}$, $V_{IN} = 0\text{ V}$	V_{SD}	-	1.13	-	V
---	----------	---	------	---	---

¹Device switched on into existing short circuit (see diagram Determination of $I_{D(lim)}$). If the device is in on condition and a short circuit occurs, these values might be exceeded for max. 50 μs .

²Integrated protection functions are designed to prevent IC destruction under fault conditions described in the data sheet. Fault conditions are considered as "outside" normal operating range. Protection functions are not designed for continuous repetitive operation.

Block Diagramm

Terms

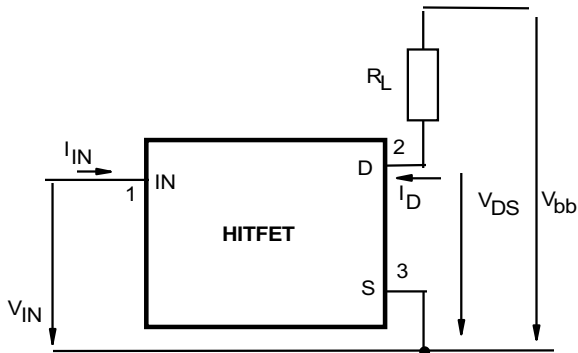

Inductive and overvoltage output clamp

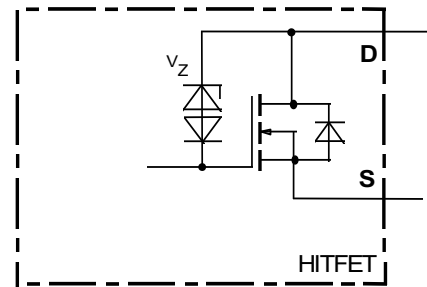

Input circuit (ESD protection)

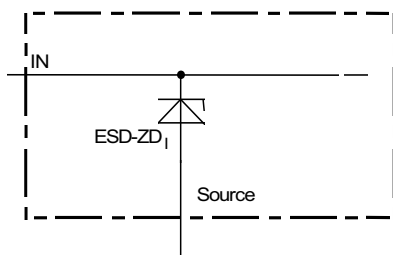

ESD zener diodes are not designed for DC current $> 2 \text{ mA}$ @ $V_{IN} > 10 \text{ V}$.

Short circuit behaviour

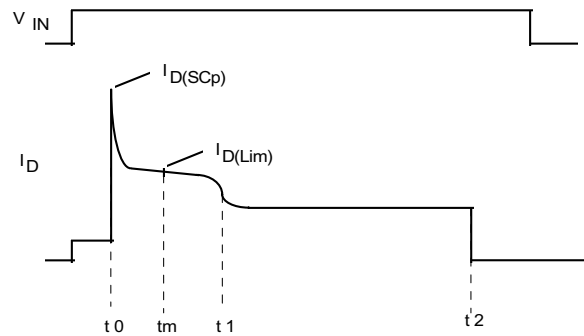

- t_0 : Turn on into a short circuit
- t_m : Measurementpoint for $I_{D(Lim)}$
- t_1 : Activation of the fast temperature sensor and regulation of the drain current to a level where the junction temperature remains constant.
- t_2 : Thermal shutdown caused by the second temperature sensor, achieved by an integrating measurement.

Maximum allowable power dissipation

$P_{tot} = f(T_c)$

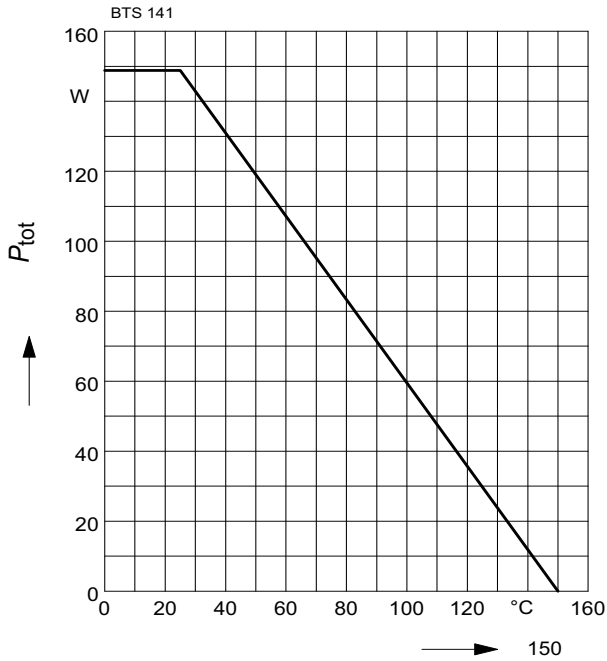

On-state resistance

$R_{ON} = f(T_j); I_D=12A; V_{IN}=10V$

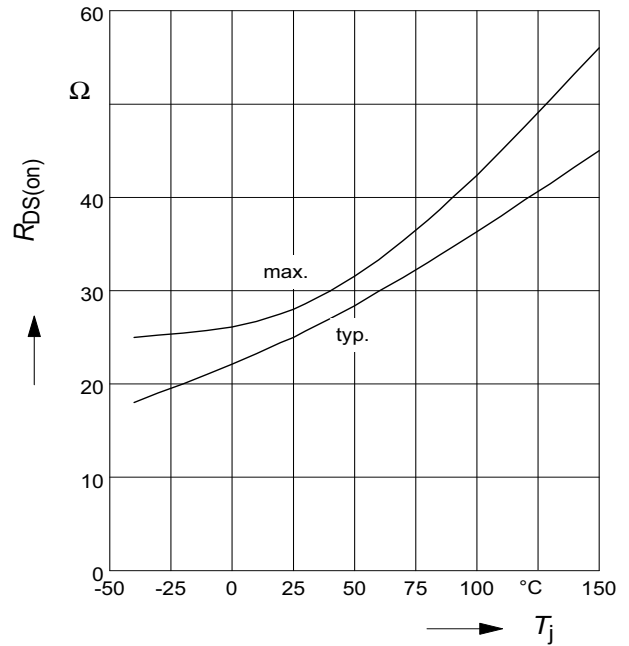

On-state resistance

$R_{ON} = f(T_j); I_D= 12A; V_{IN}=5V$

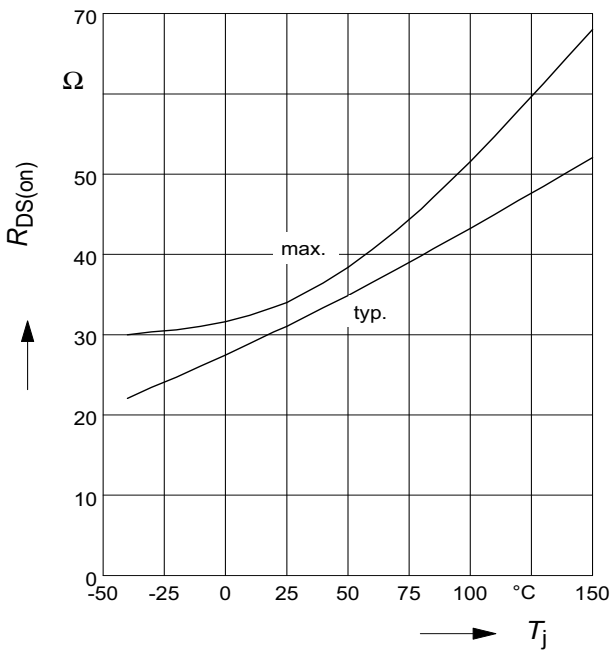

Typ. input threshold voltage

$V_{IN(th)} = f(T_j); I_D=2,7mA; V_{DS}=12V$

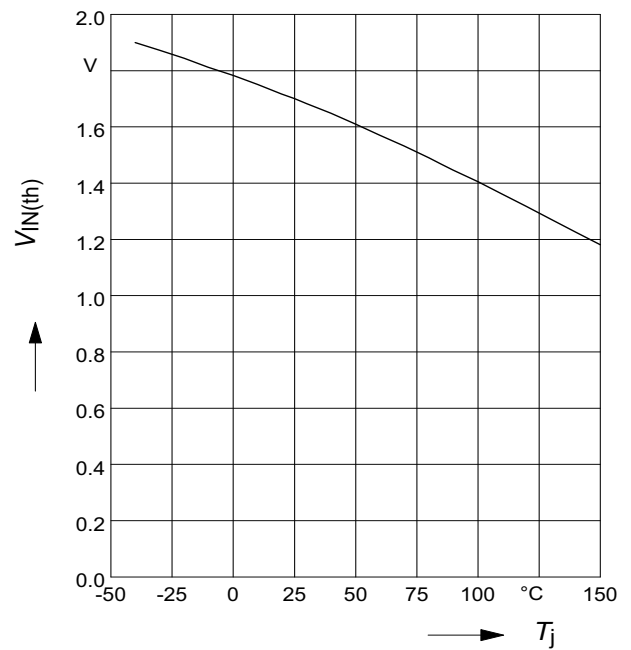

Typ. transfer characteristics

$I_D = f(V_{IN}); V_{DS}=12V; T_j=25^\circ C$

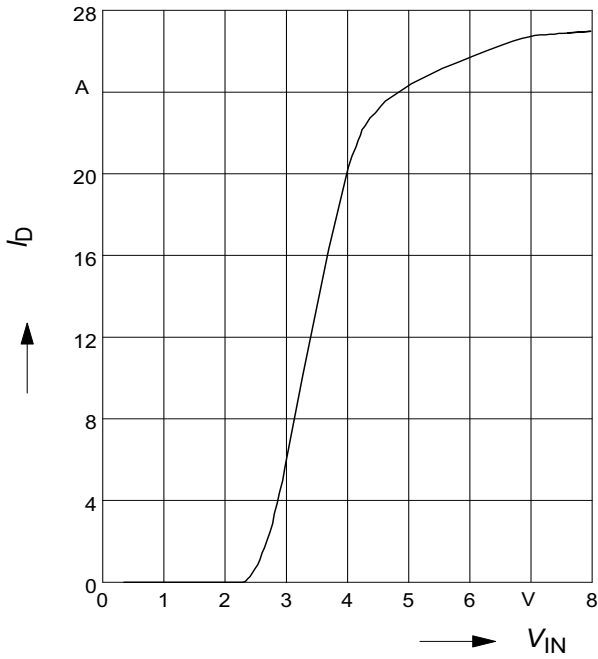

Typ. output characteristic

$I_D = f(V_{DS}); T_j=25^\circ C$

Parameter: V_{IN}

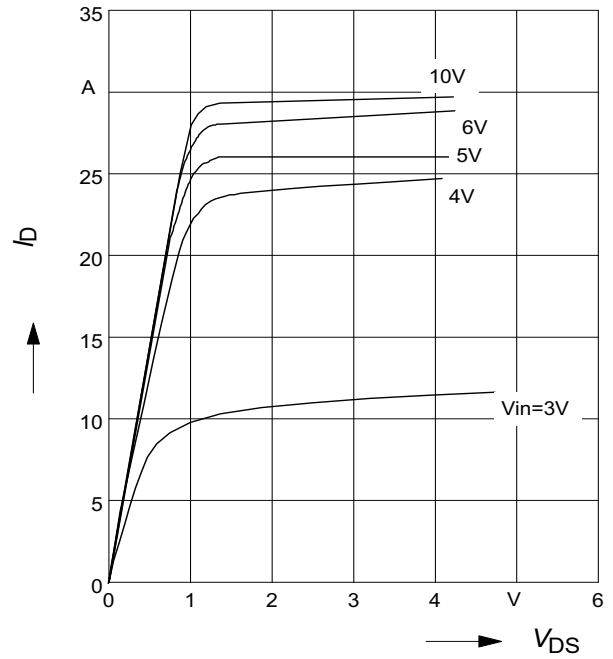

Transient thermal impedance

$Z_{thJC} = f(t_p)$

parameter : $D = t_p/T$

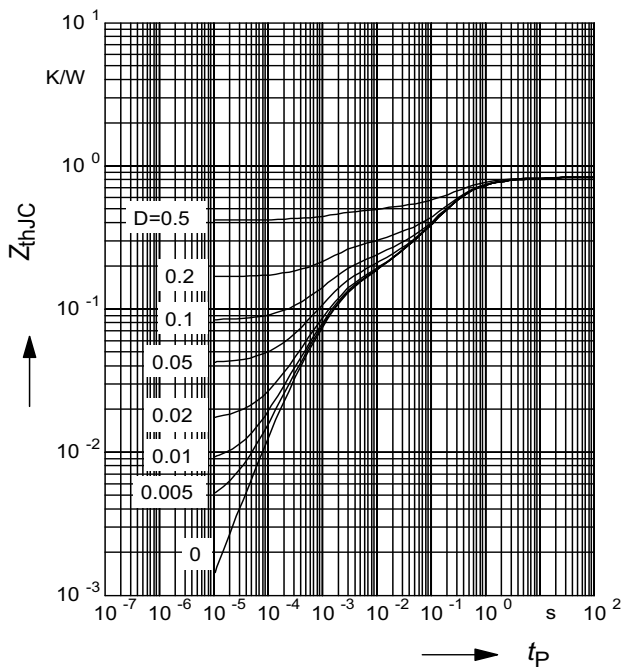

Application examples:

Status signal of thermal shutdown by monitoring input current

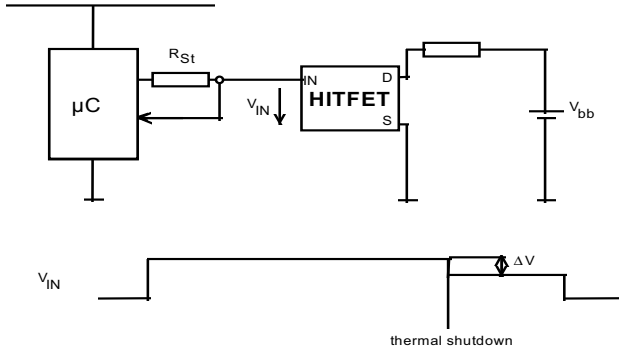

$$\Delta V = R_{ST} * I_{N(3)}$$

1 Package Outlines

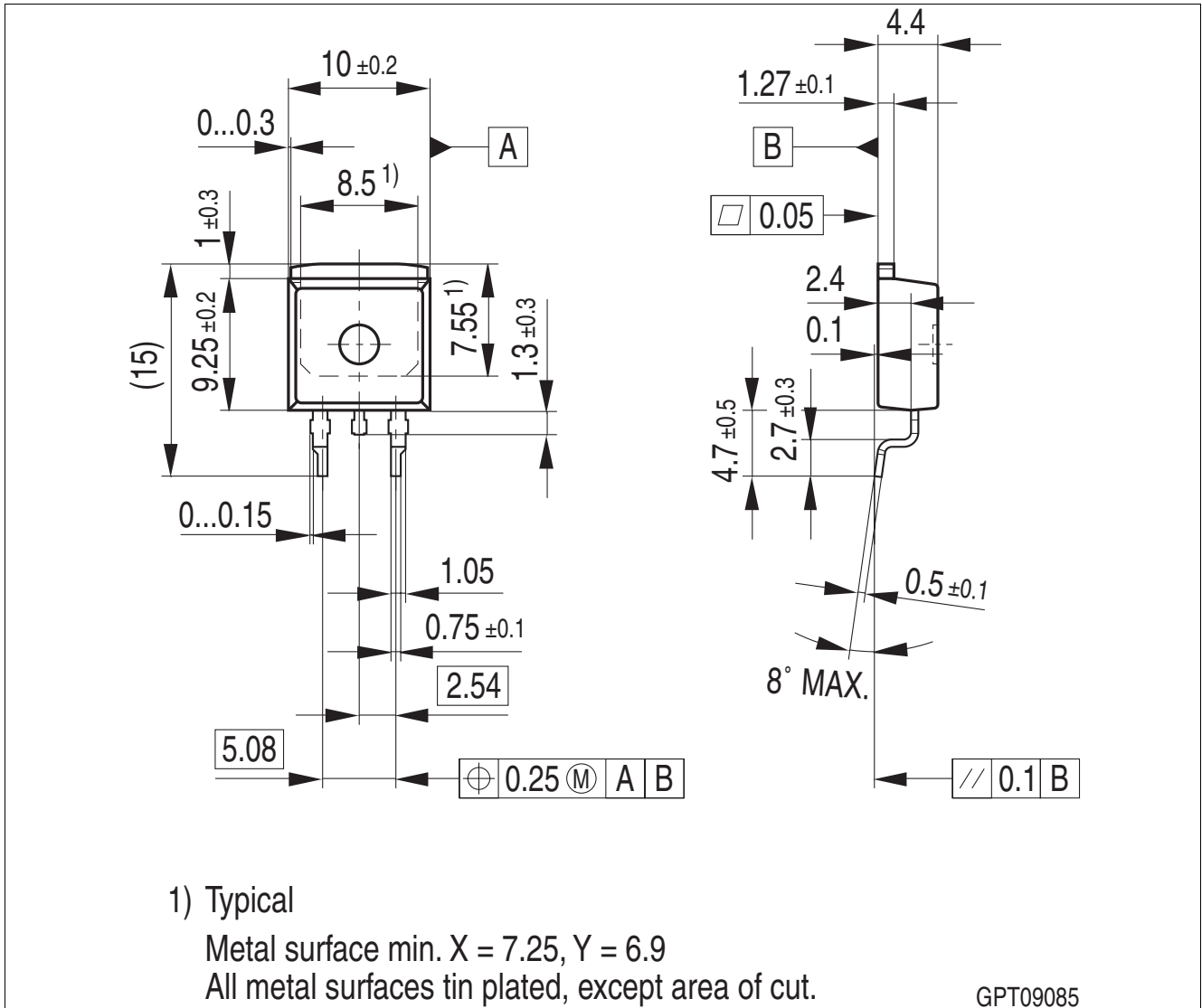

Figure 1 PG-T0263-3-2

To meet the world-wide customer requirements for environmentally friendly products and to be compliant with government regulations the device is available as a green product. Green products are RoHS-Compliant (i.e Pb-free finish on leads and suitable for Pb-free soldering according to IPC/JEDEC J-STD-020).

You can find all of our packages, sorts of packing and others in our Infineon Internet Page "Products": <http://www.infineon.com/products>.

Dimensions in mm

2 Revision History

Version	Date	Changes
Rev. 1.0	2009-07-20	released initial Datasheet

Edition 2009-07-20

**Published by
Infineon Technologies AG
81726 Munich, Germany**

**© Infineon Technologies AG 2009.
All Rights Reserved.**

Legal Disclaimer

The information given in this document shall in no event be regarded as a guarantee of conditions or characteristics ("Beschaffenhheitsgarantie"). With respect to any examples or hints given herein, any typical values stated herein and/or any information regarding the application of the device, Infineon Technologies hereby disclaims any and all warranties and liabilities of any kind, including without limitation warranties of non-infringement of intellectual property rights of any third party.

Information

For further information on technology, delivery terms and conditions and prices please contact your nearest Infineon Technologies Office (www.infineon.com).

Warnings

Due to technical requirements components may contain dangerous substances. For information on the types in question please contact your nearest Infineon Technologies Office.

Infineon Technologies Components may only be used in life-support devices or systems with the express written approval of Infineon Technologies, if a failure of such components can reasonably be expected to cause the failure of that life-support device or system, or to affect the safety or effectiveness of that device or system. Life support devices or systems are intended to be implanted in the human body, or to support and/or maintain and sustain and/or protect human life. If they fail, it is reasonable to assume that the health of the user or other persons may be endangered.