



Photointerrupter Product Data Sheet

LTH-1650-01

Spec No.: DS-55-95-0009

Effective Date: 01/06/2001

Revision: B

LITE-ON DCC

RELEASE

BNS-OD-FC001/A4

FEATURES

- * FOCAL DISTANCE: 3 mm.
- * INFRARED RAY CUT-OFF TYPE.

APPLICATION

- * PRINTER
- * FAX
- * OPTOELECTRONIC SWITCHES

PACKAGE DIMENSIONS

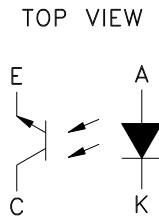
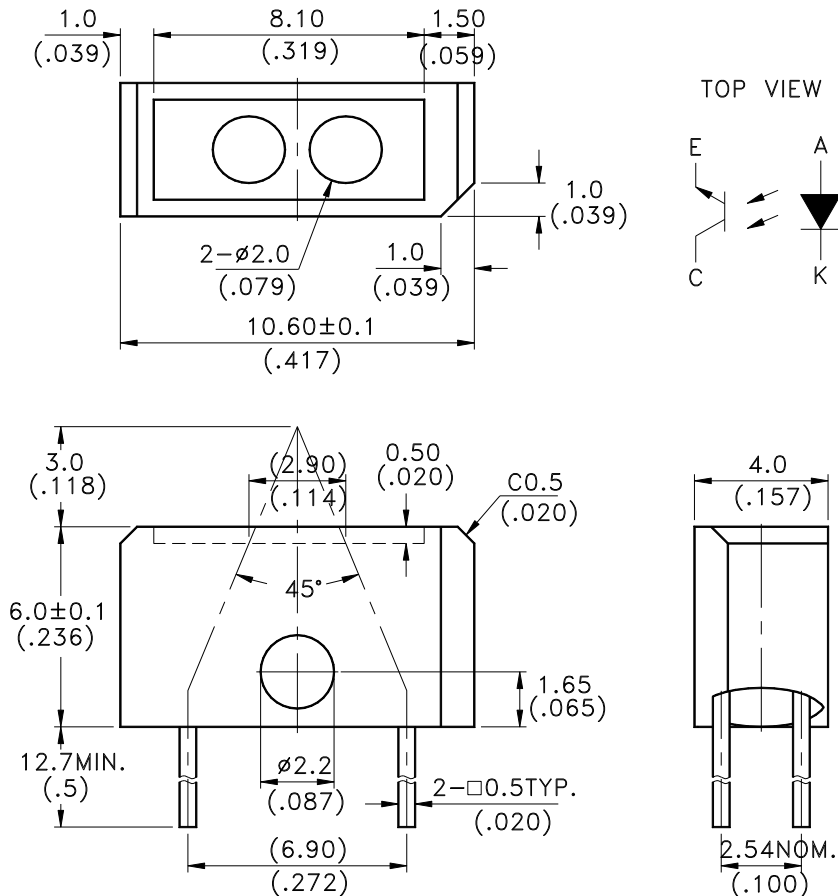

NOTES:

1. All dimensions are in millimeters (inches).
2. Tolerance is ±0.25mm(.010") unless otherwise noted.

ABSOLUTE MAXIMUM RATINGS AT TA=25°C

PARAMETER	SYMBOL	MAXIMUM RATING	UNIT
INPUT LED			
Power Dissipation	P _D	75	mW
Peak Forward Current (300 pps , 10 μ S pulse)	I _{CP}	1	A
Continuous Forward Current	I _F	60	mA
Reverse Voltage	V _R	5	V
OUTPUT PHOTOTRANSISTOR			
Power Dissipation	P _C	100	mW
Collector-Emitter Voltage	V _{CEO}	30	V
Emitter-Collector Voltage	V _{ECO}	5	V
Collector Current	I _C	20	mA
Operating Temperature Range	T _{opr}	-25°C to + 85°C	
Storage Temperature Range	T _{stg}	-40°C to + 100°C	
Lead Soldering Temperature [1.6mm (.063") Form Case]	T _S	260°C for 5 Seconds	

ELECTRICAL OPTICAL CHARACTERISTICS AT $T_A=25^\circ\text{C}$

PARAMETER	SYMBOL	MIN.	TYP.	MAX.	UNIT	TEST CONDITION
INPUT LED						
Forward Voltage	V_F		1.2	1.6	V	$I_F = 20\text{mA}$
Reverse Current	I_R			100	μA	$V_R = 5\text{V}$
OUTPUT PHOTOTRANSISTOR						
Collector-Emitter Dark Current	I_{CEO}			100	nA	$V_{CE} = 10\text{V}$
COUPLER						
Collector-Emitter Saturation Voltage	$V_{CE(SAT)}$			0.4	V	$I_C = 0.05\text{mA}$ $I_F = 20\text{mA}$
On State Collector Current	$I_{C(ON)}$	100		300	μA	$V_{CE} = 5\text{V}$ $I_F = 20\text{mA}$ $d = 3.0\text{mm}$
		260		650		BIN B
		400		1200		BIN C
Response Time	Rise Time	T_R		3	μS	$V_{CE} = 5\text{V}$, $I_C = 2\text{mA}$ $R_L = 100\ \Omega$
	Fall Time	T_F		4		

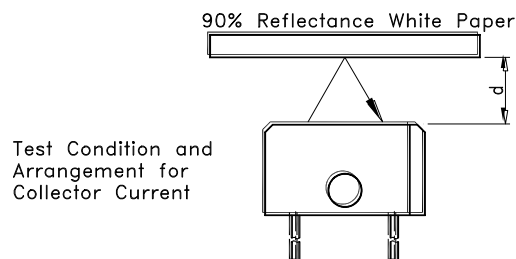

TYPICAL ELECTRICAL / OPTICAL CHARACTERISTICS CURVES

(25°C Ambient Temperature Unless Otherwise Noted)

Fig.1 Power Dissipation vs. Ambient Temperature

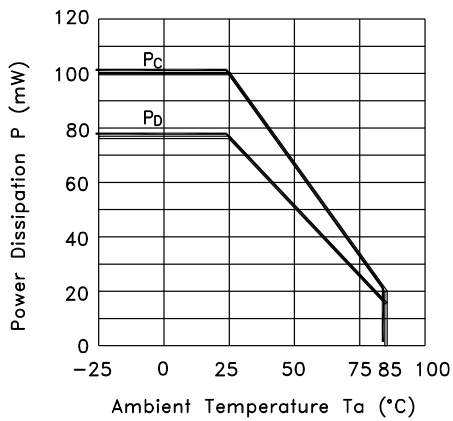

Fig.2 Forward Current vs. Forward Voltage

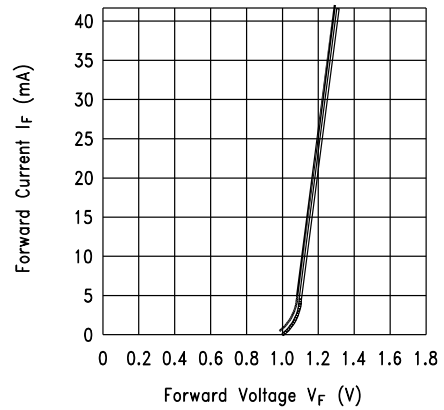

Fig.3 Collector Current vs. Collector-emitter Voltage

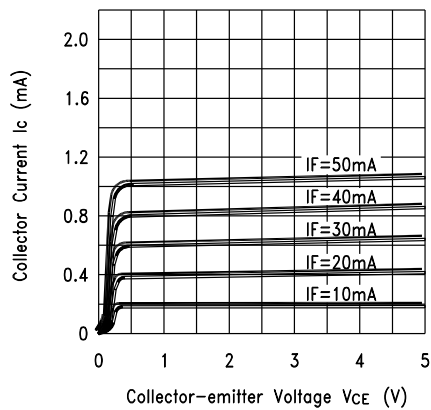
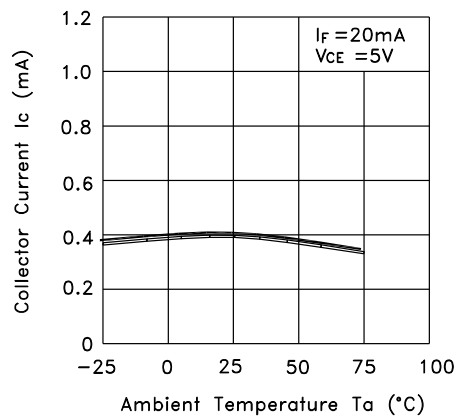

Fig.4 Collector Current vs. Ambient Temperature



TYPICAL ELECTRICAL / OPTICAL CHARACTERISTICS CURVES

(25°C Ambient Temperature Unless Otherwise Noted)

Fig.5 Collector-emitter Saturation vs. Voltage Ambient Temperature

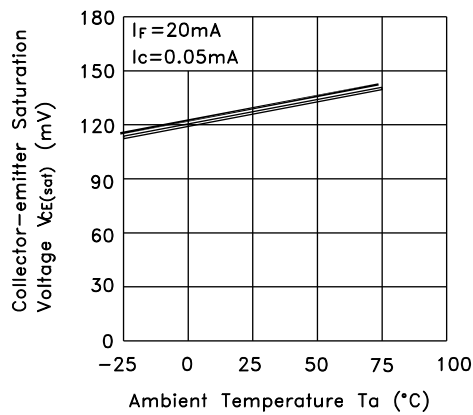

Fig.6 Relative Collector Current vs. Object Distance

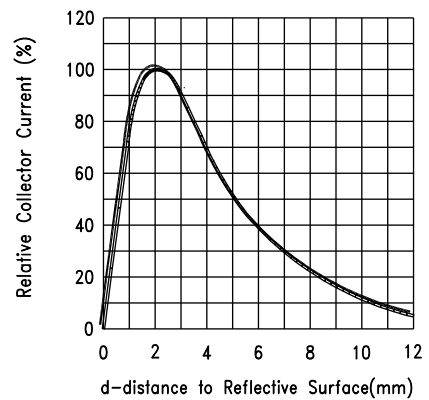
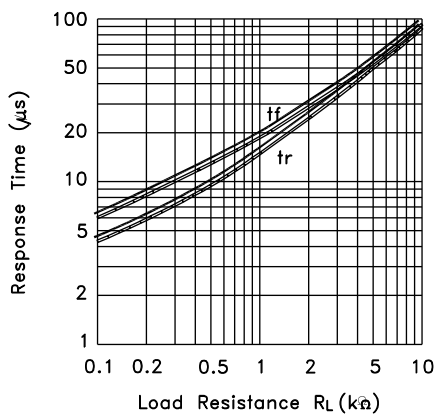

Fig.7 Response Time vs. Load Resistance



Test Circuit for Response Time

