

Fuseholder Open Design, 6.3 x 32 mm, THT



2.5W / 10A @Tu 23°C · 500VAC · 16A (UL)

See below:

[Approvals and Compliances](#)

### Description

- Through hole mounting

### Weblinks

[pdf data sheet](#), [html datasheet](#), [General Product Information](#), [Distributor-Stock-Check](#), [Detailed request for product](#), [Microsite](#)

### Technical Data

Fuse-Link	6.3 x 32mm	Soldering Methods	Wave <a href="#">Soldering Profile</a>
Mounting	PCB	Solderability	245 °C / 3 sec acc. to IEC 60068-2-20, Test Ta, method 1
Attachment	Screw/rivet/THT	Resistance to Soldering Heat	260 °C / 10 sec acc. to IEC 60068-2-20, Test Tb, method 1A
Terminal	Solder THT	Solderability	245 °C / 3 sec acc. to IEC 60068-2-20, Test Ta, method 1
Rated Voltage	500 VAC (UL)	Contact Resistance	≤ 10 mΩ at 100 mA acc. to IEC 60127-6
Rated current	16A (UL)	Dielectric Strength	> 3kV between life parts (50Hz: 1 min)
Rated Power Acceptance IEC	2.5W / 10A @Tu 23°C	Impulse Withstand Voltage	> 4kV between life parts
Admissible Ambient Air Temp.	-40 °C to 85 °C	Insulation Resistance	> 10 MΩ between life parts (500VDC: 1 min)
Climatic Category	40/085/21 acc. to IEC 60068-1		
Material: Terminals	Copper alloy, tin-plated		
Unit Weight	7.23 g		
Storage Conditions	0 °C to 60 °C, max. 70% r.h.		
Product Marking	Rated Voltage, Rated current, Certification marks		

### Approvals and Compliances

Detailed information on product approvals, code requirements, usage instructions and detailed test conditions can be looked up in [Details about Approvals](#)

SCHURTER products are designed for use in industrial environments. They have approvals from independent testing bodies according to national and international standards. Products with specific characteristics and requirements such as required in the automotive sector according to IATF 16949, medical technology according to ISO 13485 or in the aerospace industry can be offered exclusively with customer-specific, individual agreements by SCHURTER.

### Approvals

The approval mark is used by the testing authorities to certify compliance with the safety requirements placed on electronic products.

Approval Reference Type: OG (Holder) 6.3x32

Approval Logo	Certificates	Certification Body	Description
	<a href="#">UL Approvals</a>	UL	UL File Number: E39328

### Product standards

Product standards that are referenced

Organization	Design	Standard	Description
	Designed according to	UL 4248-1	Industrial Control Equipment
	Designed according to	CSA C22.2 no. 4248.1	Industrial Control Equipment





## Application standards

Application standards where the product can be used

Organization	Design	Standard	Description
	Designed for applications acc.	IEC/UL 62368-1	Audio/video, information and communication technology equipment - Part 1: Safety requirements

## Compliances

The product complies with following Guide Lines

Identification	Details	Initiator	Description
	<a href="#">CE declaration of conformity</a>	SCHURTER AG	The CE marking declares that the product complies with the applicable requirements laid down in the harmonisation of Community legislation on its affixing in accordance with EU Regulation 765/2008.
	<a href="#">UKCA declaration of conformity</a>	SCHURTER AG	The UKCA marking declares that the product complies with the applicable requirements laid down in the British Amendment of Regulation (EC) 765/2008.
	RoHS	SCHURTER AG	Directive RoHS 2011/65/EU, Amendment (EU) 2015/863
	China RoHS	SCHURTER AG	The law SJ / T 11363-2006 (China RoHS) has been in force since 1 March 2007. It is similar to the EU directive RoHS.
	REACH	SCHURTER AG	On 1 June 2007, Regulation (EC) No 1907/2006 on the Registration, Evaluation, Authorization and Restriction of Chemicals 1 (abbreviated as "REACH") entered into force.

## Dimension [mm]

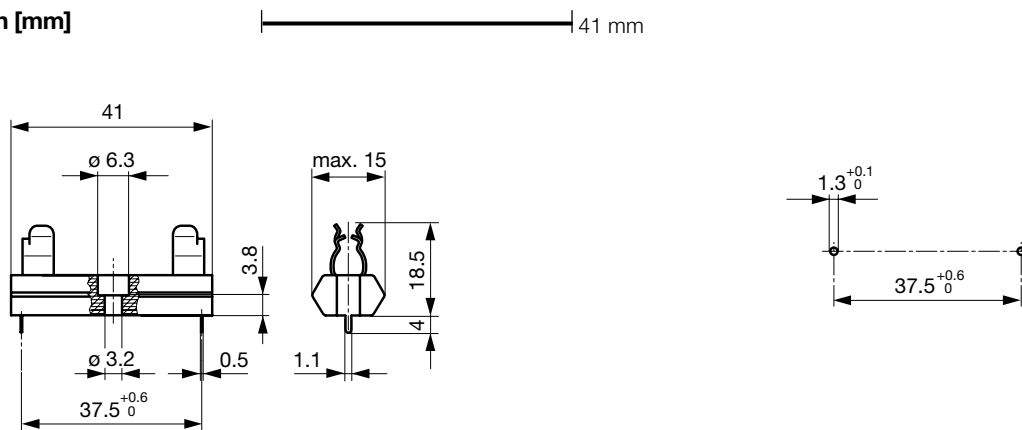

Drilling diagram

## Derating Curves

acc. to IEC

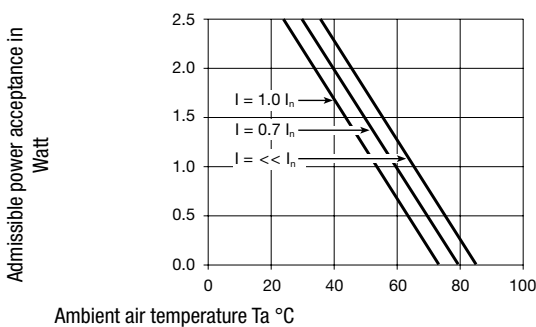

## All Variants

Holder	Order Number
●	0031.8002

 Most Popular.

Availability for all products can be searched real-time: <https://www.schurter.com/en/Stock-Check/Stock-Check-SCHURTER>

**Packaging Unit**

Bulk (100 pcs.)

---