

# SBT-90 Specialty White LED

## Second Generation

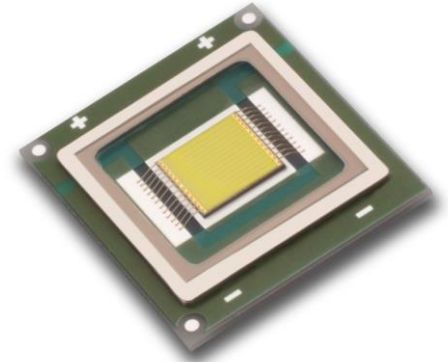

### Table of Contents

General Considerations . . . . .	2
Binning Structure . . . . .	3
Chromaticity Bins . . . . .	4
Ordering Information . . . . .	5
Product Characteristics . . . . .	6
Optical vs Electrical vs Thermal Characteristics . . . . .	7 - 9
Mechanical Dimensions . . . . .	10
History of Changes . . . . .	13

### Features:

- Large, monolithic chip with uniform emitting area of 9mm<sup>2</sup>
- Extremely high optical output: up to 5,400 lumens at 18A from a single chip.
- Un-encapsulated die ideal for optical coupling in Etendue-limited applications.
- 5700K typical color temperature.
- High thermal conductivity package - junction to case thermal resistance of only 0.5 °C/W.
- Compact 10 x 11mm<sup>2</sup> isolated surface mount package.
- Environmentally friendly, compliant with RoHS and REACH requirements

### Applications

- Fiber-coupled illumination: endoscopy, machine vision, instrumentation.
- Architectural and Entertainment lighting - Narrow beam spotlights.
- Beacons
- Search lights
- Automotive after-market / Tuning spotlights
- Tactical portable lighting

**Environmental Benefits:**

As a leading provider of solid-state Lighting solutions, Luminus implements strict substance control policies to ensure all of its products are environmentally friendly. As all Luminus LEDs, the SBT-90 series are compliant with the Restriction of Hazardous Substances (RoHS) and REACH directives from the European Community. Restricted materials including lead, mercury, cadmium, hexavalent chromium, polybrominated biphenyls (PBB) and polybrominated diphenyl ether (PBDE) are not used.

**Product Testing:**

Luminus surface mount LEDs are production tested at 9 A with a 20 mSec input pulse and a junction temperature of approximately 25°C. Expected flux values under actual application conditions can be extrapolated based on the information contained within this product data sheet.

**Reliability:**

Luminus SBT-90 LEDs are required to pass a rigorous suite of environmental and mechanical stress tests, including mechanical shock, vibration, temperature cycling and humidity. These tests ensure that the devices deliver high performance and achieve reliable long term operation in demanding high power applications. Please contact Luminus for further information.

## SBT-90 Binning Structure

SBT-90 LEDs are tested for luminous flux and chromaticity of the drive current specified below and placed into one of the following luminous flux (FF) and chromaticity (WW) bins:

### Flux Bins

Color	Flux Bin (FF)	Minimum Flux (lm) @ 9.0A	Maximum Flux (lm) @ 9.0A
W57S 5700K Standard CRI (typ. 70)	RB	2600	2780
	SA	2780	2990
	SB	2990	3200
	TA	3200	3440
	TB	3440	3680
	UA	3680	3955
	UB	3955	4230

Note 1: Luminus maintains a +/- 6% tolerance on flux measurements, and +/- 2% on CRI measurements.

Note 2: Products are production tested then sorted and packed by bin.

Note 3: Individual bins are not orderable. Please refer to the Product Ordering information page for a list of orderable bin kits

### Chromaticity Bins

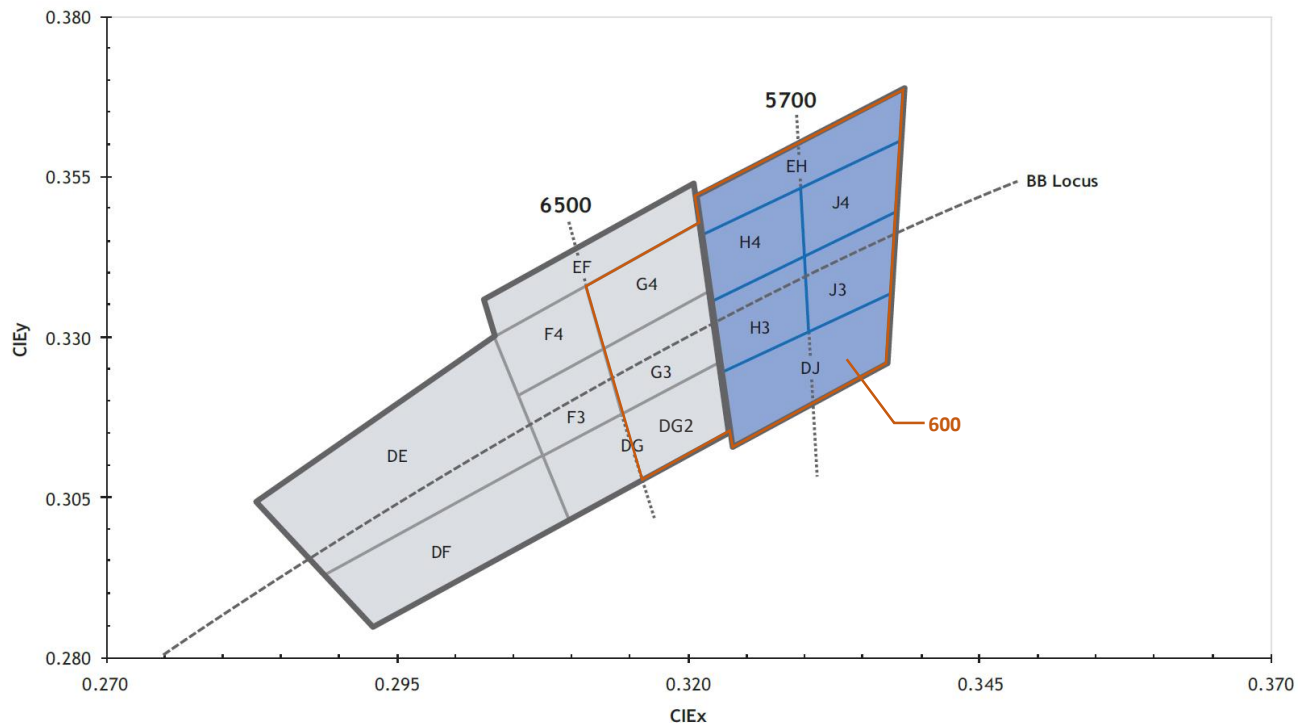

Luminus' Standard Chromaticity Bins: 1931 CIE Curve

The following tables describe the four chromaticity points that bound each chromaticity bin. Chromaticity bins are grouped together based on the color temperature.

5700K Chromaticity Bins		
Bin Code (WW)	CIE <sub>x</sub>	CIE <sub>y</sub>
DJ	0.322	0.324
	0.337	0.337
	0.336	0.326
	0.323	0.314
H3*	0.321	0.335
	0.329	0.342
	0.329	0.331
	0.322	0.324
H4*	0.321	0.346
	0.329	0.354
	0.329	0.342
	0.321	0.335

5700K Chromaticity Bins		
Bin Code (WW)	CIE <sub>x</sub>	CIE <sub>y</sub>
J3*	0.329	0.342
	0.337	0.349
	0.337	0.337
	0.330	0.331
J4*	0.329	0.354
	0.338	0.362
	0.337	0.349
	0.329	0.342
EH	0.320	0.352
	0.338	0.368
	0.338	0.362
	0.321	0.346

6500K Chromaticity Bins		
Bin Code (WW)	CIE <sub>x</sub>	CIE <sub>y</sub>
DG2	0.315	0.319
	0.322	0.326
	0.323	0.316
	0.316	0.309
G3	0.313	0.329
	0.321	0.337
	0.322	0.326
	0.315	0.319
G4	0.312	0.339
	0.321	0.348
	0.321	0.337
	0.313	0.329

\*Sub-bins within ANSI defined quadrangles per ANSI C78.377-2008

## Ordering Information

### Ordering Part Numbers

Color Point	Code of Minimum Bin	Minimum flux (lm)	Chromaticity Bins <sup>1</sup>	Bin Kit	Ordering Part Number
WDS	RB	2600	G3, G4, H3, H4, J3, J4, DG2, EH, DJ	RB600	SBT-90-WDS-F72-RB600
	SA	2780	G3, G4, H3, H4, J3, J4, DG2, EH, DJ	SA600	SBT-90-WDS-F72-SA600

**EXAMPLE:**

The part number SBT-90-WDS-F72-RB600 refers to a Daylight Color temperature with standard CRI white, SBT-90 emitter, with minimum flux of 2600 lumens and a chromaticity value within the boxes defined on the chromaticity bin as shown on page 4.

Note 1: Some flux and chromaticity bins may have limited availability. Application specific bin kits, consisting of multiple bins, may be available.

### Part Numbering Nomenclature

Product Family	LED emission area	Color code	Configuration	Flux Bin kit	Chromaticity Bin
Surface Mount (Window)	90 = 9.0 mm <sup>2</sup>	W = White t: Color Temperature -D : Daylight -C : Cool White -S : Stage White c: CRI -S : Standard	Internal configuration code F71: Ceramic Package F72: Second generation	See page 3 for bins	See page 4 for bins

## Product Characteristics and Ratings

### Product Characteristics

Unless specified otherwise, all characteristics are based on a input of  $I_f = 9.0$  A (20ms pulse),  $T_j \sim 25^\circ\text{C}$ .

	Symbol		Value	Unit
Emitting Area		typ.	9.0	mm <sup>2</sup>
Emitting Area Dimension <sup>1</sup>	$A_e$	typ.	3 x 3	mm x mm
Luminus Flux	$\phi_v$	typ.	3100	Lumens
Radiometric Flux	$\phi_e$	typ.	9.25	watts
Viewing angle (50% of peak flux)	$2\phi_{1/2}$	typ.	120	degrees
Forward Voltage	$V_F$	min.	2.8	V
		typ.	3.1	
		max.	3.8	
Color Rendering Index	CRI	typ.	70	

Note 1: Please refer to mechanical drawing for dimensions and tolerance.

### Absolute Maximum Ratings

	Symbol	Value	Unit
Maximum Current (CW) <sup>1</sup>	$I_F$	18	A
Minimum Current (CW) <sup>2</sup>	$I_F$	0.2	A
Maximum surge Current ( $t < 10$ ms, Duty cycle $< 0.1$ )	$I_S$	27	A
Maximum reverse Current <sup>3</sup>	$I_R$	N/A	A
Maximum Junction operating temperature <sup>4</sup>	$T_j$	150	°C
Storage Temperature range		-40 to 130	°C
Operating Temperature range		-40 to 85	°C

Note 1: Sustained operation at maximum current will result in shortened lifetime

Note 2: Device is designed an optimized for operation near 9 A and operation at low current may result in variable performance. Contact Luminus for more information

Note 3: Not designed for reverse current operation

Note 4: Sustained operation at maximum operating  $T_j$  will result is shortened lifetime and may cause premature product failure

## Optical vs Electrical vs Thermal Characteristics

### Relative Luminous Flux vs. $I_f$

$\phi_v/\phi_v(9.0A)$ , 20ms pulse,  $T_j \sim 25^\circ C$

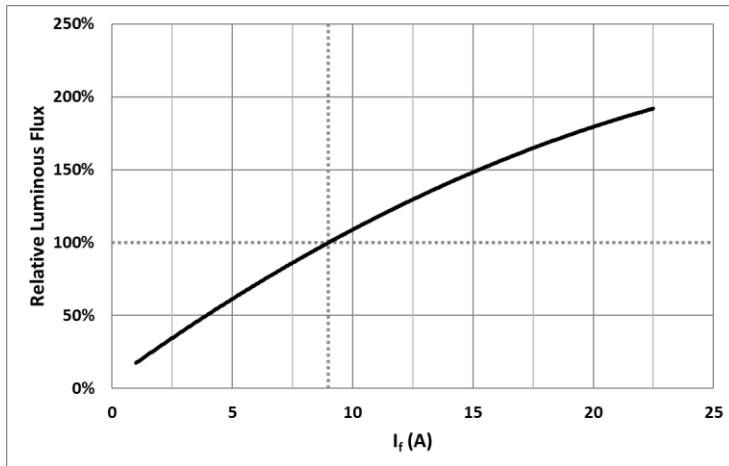

### Relative Luminous Flux vs. $T_j$

$\phi_v/\phi_v(T_j)$ ,  $I_f = 9.0A$  20ms pulse

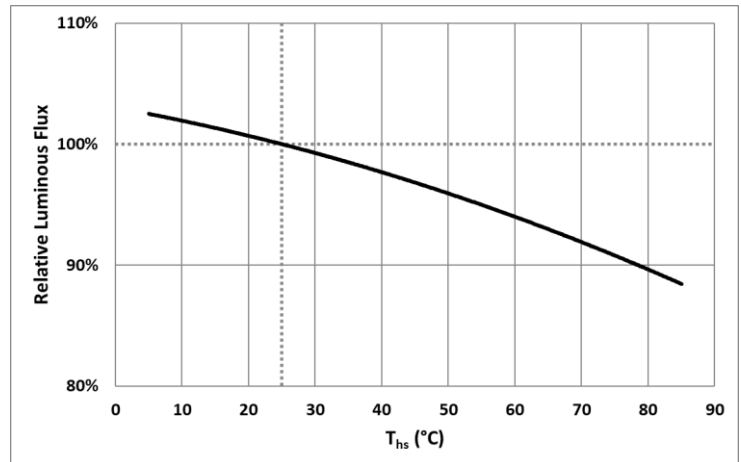

### Forward Voltage vs. $I_f$

$V_f = f(I_f)$ , 20ms pulse,  $T_j \sim 25^\circ C$

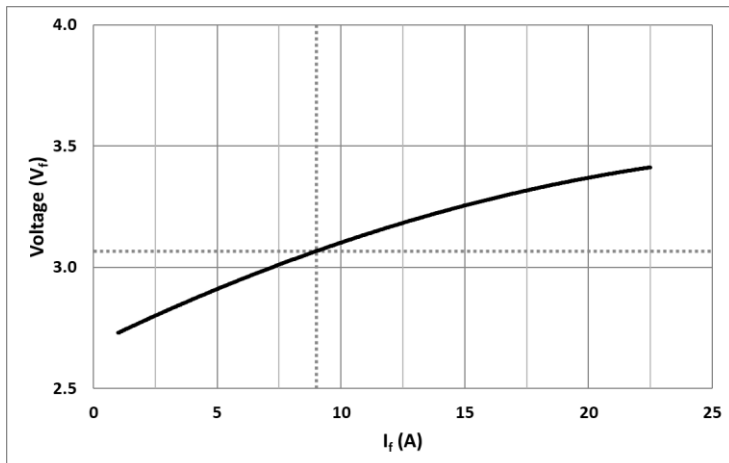

### Relative Forward Voltage vs. $T_j$

$\phi_v/\phi_v(T_j)$ ,  $I_f = 9.0A$  20ms pulse

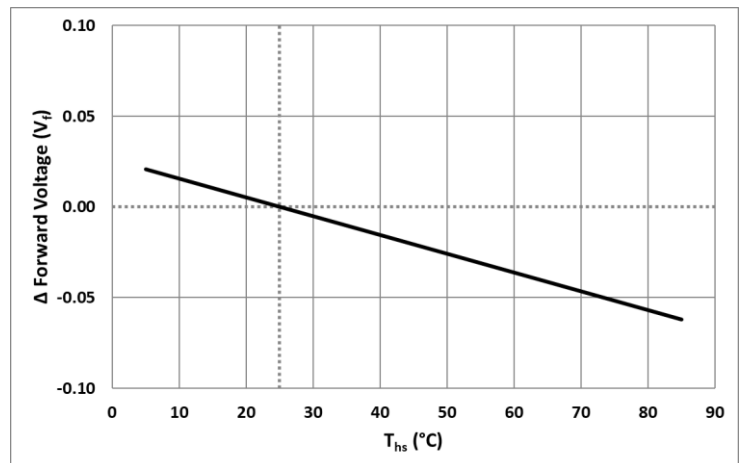

## Optical vs Electrical vs Thermal Characteristics

### Relative Chromaticity Shift vs. $I_f$

$\Delta CIE_{x,y} = CIE_{x,y}(I_f) - CIE_{x,y}(9.0A)$ , 20ms pulse,  $T_j \sim 25^\circ C$

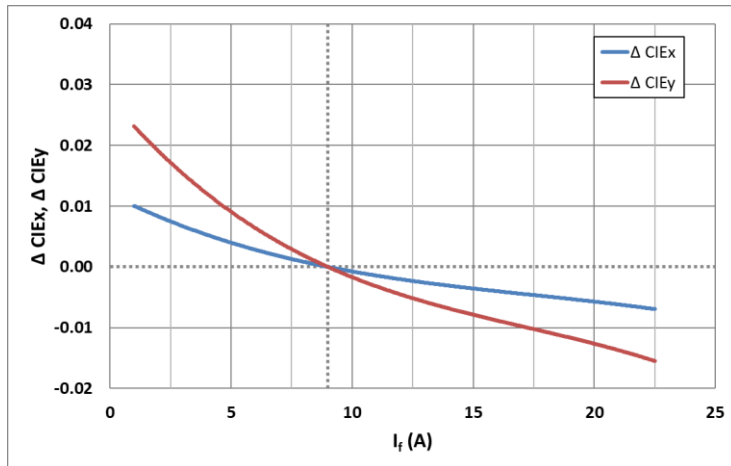

### Relative Chromaticity Shift vs. $T_j$

$\Delta CIE_{x,y} = CIE_{x,y}(T_j) - CIE_{x,y}(25^\circ C)$ ,  $I_f = 9.0A$  20ms pulse

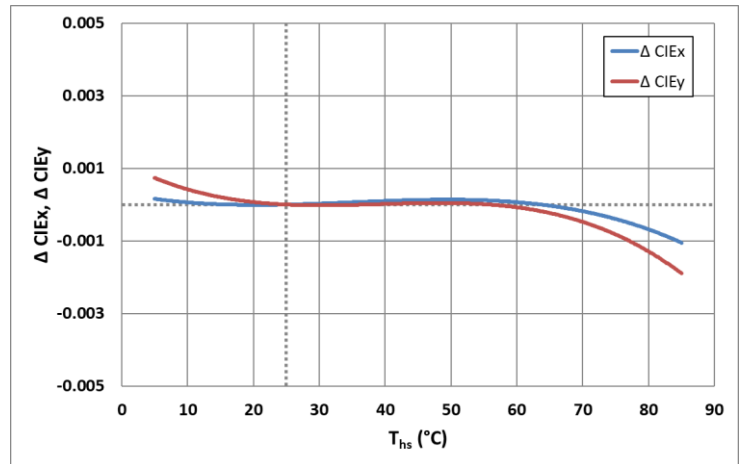

## Spectral Characteristics

### Typical Radiation Pattern

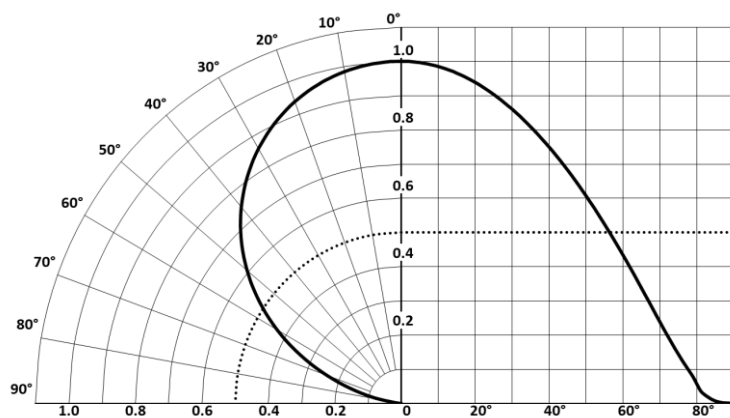

### Typical Spectrum

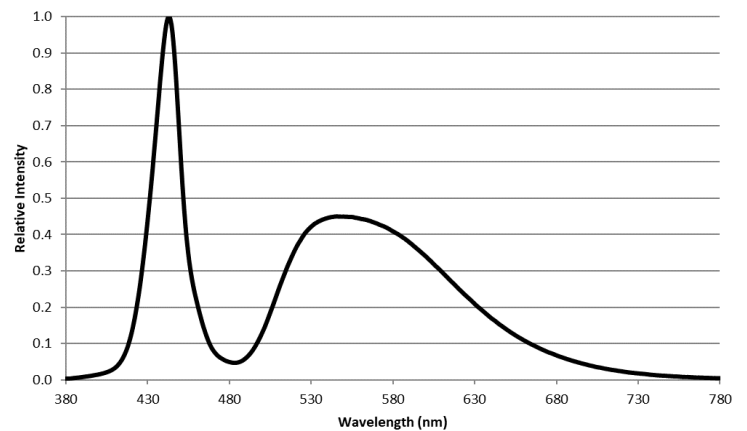



## Thermal Characteristics

### Typical Thermal Resistance:

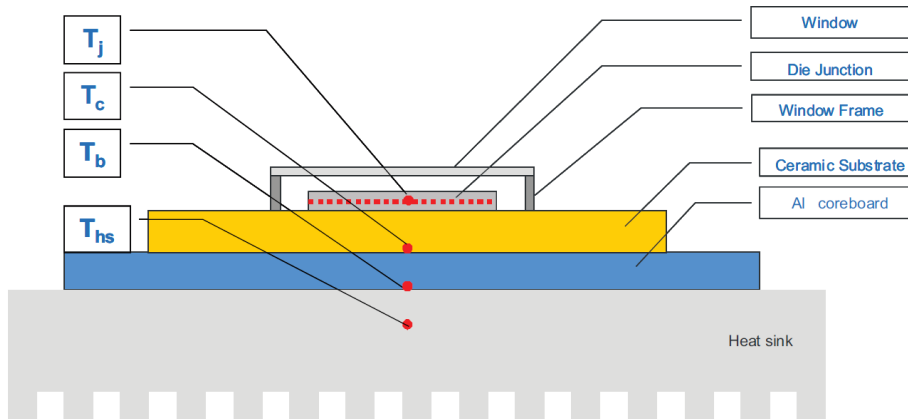

$R_{j-c}$	0.35 °C/W
$R_{j-b}$	0.9 °C/W
$R_{j-hs}$	1.35 °C/W

- Note 1: Thermal resistance values are based on FEA model results correlated to measured  $R_{\theta j-hs}$  data
- Note 2: Thermal resistance is measured at 9A using a SAC305 solder, a Bergquist Al-clad MCPCB, and eGraf 1205 thermal interface material.

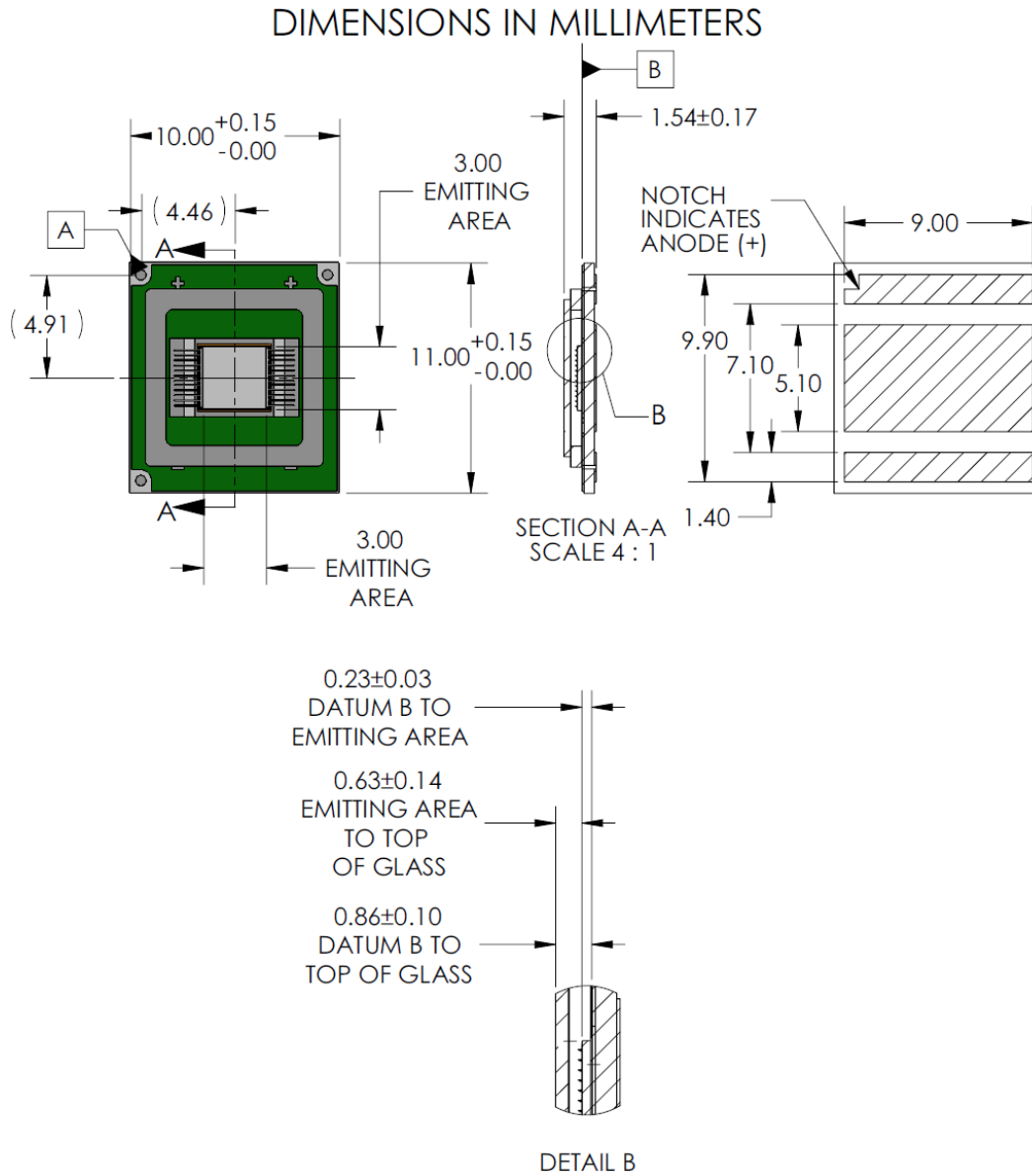
**Mechanical Dimensions – SBT-90 Emitter**

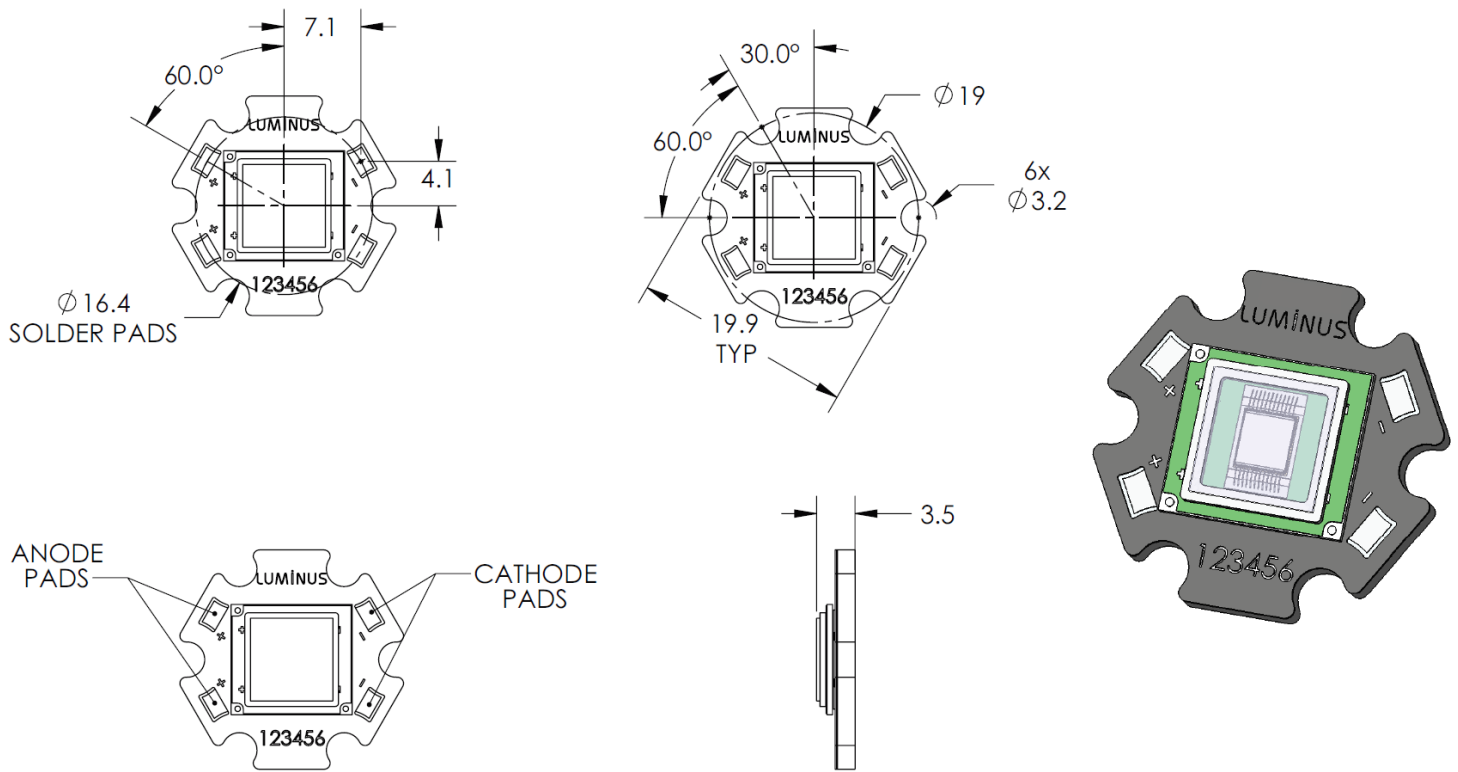
**Mechanical Dimensions – SBT-90 with Star Board**

Note 1: All dimensions in millimeters

Note 2: Tolerances per IPC-610, Class 2

Note 3: Recommended mounting screw: M3 or #4

Note 4: All anode pads on board are interconnected. All cathode pads on board are interconnected

## Solder Profile

### SAC 305 Reflow Profile Window for Low Density Boards

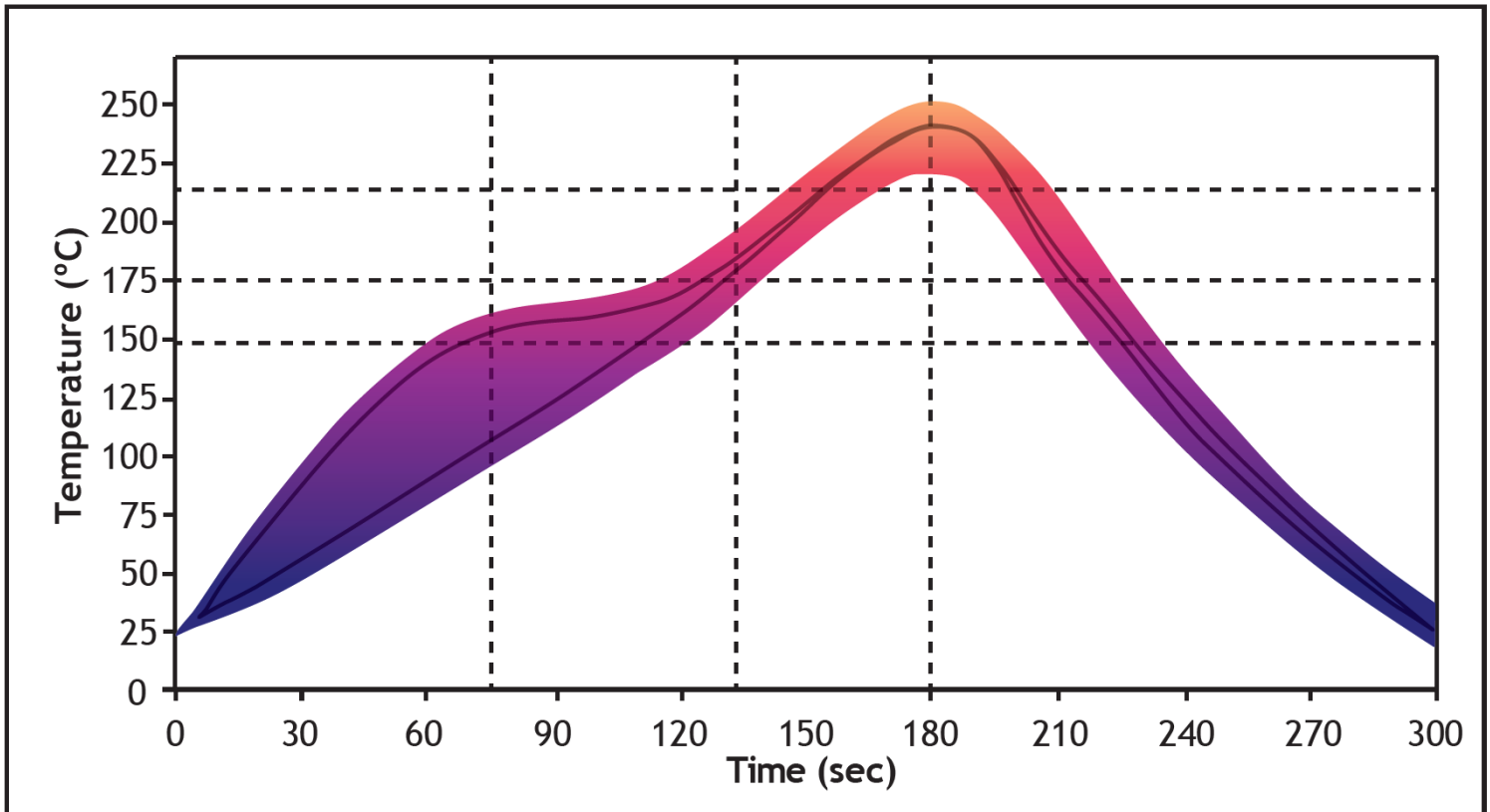

### Lead free solder guideline for low density boards

Solder Profile Stage	Lead-Free Solder
Profile length, Ambient to Peak	2.75 - 3.5 minutes
Time above 217° C	30 - 60 seconds
Cool-down Rate	≤4° C/sec
Cool-down duration	45 ± 15 sec

Note 1: Temperatures are taken and monitored at the component copper layer

Note 2: Optimum profile may differ due to oven type, circuit board or assembly layout

Note 3: Recommended lead free, no-clean solder: AIM NC254-SAC305

Note 4: Refer to APN-001473 soldering and handling application note for additional solder profiles and details

Note 5: MSL- 1 Level

## History of Changes

Revision	Date	Description of changes
01	04/10/2018	Initial Revision

*The products, their specifications and other information appearing in this document are subject to change by Luminus Devices without notice. Luminus Devices assumes no liability for errors that may appear in this document, and no liability otherwise arising from the application or use of the product or information contained herein. None of the information provided herein should be considered to be a representation of the fitness or suitability of the product for any particular application or as any other form of warranty. Luminus Devices' product warranties are limited to only such warranties as accompany a purchase contract or purchase order for such products. Nothing herein is to be construed as constituting an additional warranty. No information contained in this publication may be considered as a waiver by Luminus Devices of any intellectual property rights that Luminus Devices may have in such information.*

*This product is protected by U.S. Patents 6,831,302; 7,074,631; 7,083,993; 7,084,434; 7,098,589; 7,105,861; 7,138,666; 7,166,870; 7,166,871; 7,170,100; 7,196,354; 7,211,831; 7,262,550; 7,274,043; 7,301,271; 7,341,880; 7,344,903; 7,345,416; 7,348,603; 7,388,233; 7,391,059 Patents Pending in the U.S. and other countries.*