

IRG4IBC10UDPbF

UltraFast Co-Pack IGBT

INSULATED GATE BIPOLAR TRANSISTOR WITH
ULTRAFast SOFT RECOVERY DIODE

Features

- UltraFast: Optimized for high operating up to 80 kHz in hard switching, >200 kHz in resonant mode
- Generation 4 IGBT design provides tighter parameter distribution and higher efficiency than previous generation
- IGBT co-packaged with HEXFRED® ultrafast, ultra-soft recovery anti-parallel diodes for use in bridge configurations
- Industry standard TO-220 Full-Pak
- Lead-Free

Benefits

- Generation 4 IGBTs offer highest efficiencies available
- IGBTs optimized for specific application conditions
- HEXFRED® diodes optimized for performance with IGBTs
Minimized recovery characteristics require less/no snubbing

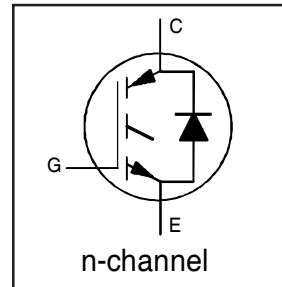

$$V_{CES} = 600V$$

$$V_{CE(on)} \text{ typ.} = 2.15V$$

$$@V_{GE}=15V, I_C=5.0A$$

$$t_f \text{ (typ.)} = 140ns$$

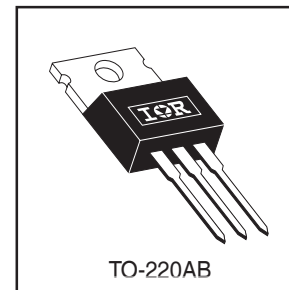

Absolute Maximum Ratings

	Parameter	Max.	Units
V_{CES}	Collector-to-Emitter Breakdown Voltage	600	V
$I_C @ T_C = 25^\circ C$	Continuous Collector Current, $V_{GE} @ 15V$	6.8	A
$I_C @ T_C = 100^\circ C$	Continuous Collector, $V_{GE} @ 15V$	3.9	
I_{CM}	Pulsed Collector Current ①	27	
I_{LM}	Clamped Inductive Load Current ②	27	
$I_F @ T_C = 100^\circ C$	Diode Continuous Forward Current ②	3.9	
I_{FM}	Diode Maximum Forward Current	27	
V_{ISOL}	rms Isolated Voltage, Terminal to case, $t=1min$	2500	V
V_{GE}	Gate-to-Emitter Voltage	± 20	
$P_D @ T_C = 25^\circ C$	Power Dissipation	25	W
$P_D @ T_C = 100^\circ C$	Power Dissipation	10	
T_J T_{STG}	Operating Junction and Storage Temperature Range	-55 to + 150	°C
	Soldering Temperature for 10 seconds	300 (0.063 in.) (1.6mm from case)	
	Mounting Torque, 6-32 or M3 Screw	10lb·in (1.1N·m)	

Thermal Resistance

	Parameter	Typ.	Max.	Units
$R_{\theta JC}$	Junction-to-Case - IGBT	—	5.0	°C/W
$R_{\theta JC}$	Junction-to-Case - Diode	—	9.0	
$R_{\theta JA}$	Junction-to-Ambient, typical socket mount	—	65	
Wt	Weight	2.1 (0.075)	—	g (oz)

IRG4IB10UDPbF

Electrical Characteristics @ $T_J = 25^\circ\text{C}$ (unless otherwise specified)

	Parameter	Min.	Typ.	Max.	Units	Conditions
$V_{(BR)CES}$	Collector-to-Emitter Breakdown Voltage ^③	600	—	—	V	$V_{GE} = 0V, I_{CE} = 250\mu A$
$\Delta V_{(BR)CES}/\Delta T_J$	Breakdown Voltage Temp. Coefficient	—	0.54	—	V/ $^\circ\text{C}$	$V_{GE} = 0V, I_{CE} = 1.0mA$
$V_{CE(on)}$	Collector-to-Emitter Saturation Voltage	—	2.15	2.6	V	$V_{GE} = 15V, I_{CE} = 5.0A$
		—	2.61	—		$V_{GE} = 15V, I_{CE} = 8.5A$
		—	2.30	—		$V_{GE} = 15V, I_{CE} = 5.0A, T_J = 150^\circ\text{C}$
$V_{GE(th)}$	Gate Threshold Voltage	3.0	—	6.0	V	$V_{CE} = V_{GE}, I_{CE} = 250\mu A$
$\Delta V_{GE(th)}/\Delta T_J$	Gate Threshold Voltage Coefficient	—	-8.7	—	mV/ $^\circ\text{C}$	
g_{fe}	Forward Transconductance ^⑤	2.8	4.2	—	S	$V_{CE} = 100V, I_{CE} = 5.0A$
I_{CES}	Collector-to-Emitter Leakage Current	—	—	250	μA	$V_{CE} = 600V, V_{GE} = 0V$
		—	—	1000		$V_{CE} = 600V, V_{GE} = 0V, T_J = 150^\circ\text{C}$
V_{FM}	Diode Forward Voltage Drop	—	1.5	1.8	V	$I_C = 4.0A$
		—	1.4	1.7		$I_C = 4.0A, T_J = 125^\circ\text{C}$
I_{GES}	Gate-to-Emitter Forward Leakage	—	—	100	nA	$V_{GE} = 20V$
	Gate-to-Emitter Reverse Leakage	—	—	-100		$V_{GE} = -20V$

Switching Characteristics @ $T_J = 25^\circ\text{C}$ (unless otherwise specified)

Q_g	Total Gate Charge (turn-on)	—	15	22	nC	$V_{CE} = 400V$
Q_{ge}	Gate-to-Emitter Charge (turn-on)	—	2.6	4.0		$I_C = 5.0A$
Q_{gc}	Gate-to-Collector Charge	—	5.8	8.7		$V_{GE} = 15V, \text{See Fig. 8}$
$t_{d(on)}$	Turn-On delay time	—	40	—	ns	$I_C = 5.0A, V_{CC} = 480V$ $V_{GE} = 15V, R_G = 100\Omega$ $T_J = 25^\circ\text{C}$
t_r	Rise time	—	16	—		
$t_{d(off)}$	Turn-Off delay time	—	87	130		
t_f	Fall time	—	140	210		
$E_{(on)}$	Turn-On Switching Loss	—	0.14	—	mJ	Energy losses include "tail" and diode reverse recovery. See Fig. 9, 10, 18
$E_{(off)}$	Turn-Off Switching Loss	—	0.12	—		
E_{ts}	Total Switching Loss	—	0.26	0.33		
$t_{d(on)}$	Turn-On delay time	—	38	—	ns	$I_C = 5.0A, V_{CC} = 480V \text{ See Fig. 11, 18}$ $V_{GE} = 15V, R_G = 100\Omega$ $T_J = 150^\circ\text{C}$ Energy losses include "tail" and diode reverse recovery.
t_r	Rise time	—	18	—		
$t_{d(off)}$	Turn-Off delay time	—	95	—		
t_f	Fall time	—	250	—		
E_{ts}	Total Switching Loss	—	0.45	—	mJ	
L_E	Internal Emitter Inductance	—	7.5	—	nH	Measured 5mm from package
C_{ies}	Input Capacitance	—	270	—	pF	$V_{GE} = 0V$
C_{oes}	Output Capacitance	—	21	—		$V_{CE} = 30V$
C_{res}	Reverse Transfer Capacitance	—	3.5	—		$f = 1.0MHz, \text{See Fig. 7}$
t_{rr}	Diode Reverse Recovery Time	—	28	42	ns	$T_J = 25^\circ\text{C}, \text{See Fig. 14}$
		—	38	57		$T_J = 125^\circ\text{C}$
I_{rr}	Diode Peak Reverse Recovery Current	—	2.9	5.2	A	$T_J = 25^\circ\text{C}, \text{See Fig. 15}$
		—	3.7	6.7		$T_J = 125^\circ\text{C}$
Q_{rr}	Diode Reverse Recovery Charge	—	40	60	nC	$T_J = 25^\circ\text{C}, \text{See Fig. 16}$
		—	70	105		$T_J = 125^\circ\text{C}$
$di_{(rec)M}/dt$	Diode Peak Rate of Fall of Recovery During t_b	—	280	—	A/ μs	$T_J = 25^\circ\text{C}, \text{See Fig. 17}$
		—	235	—		$T_J = 125^\circ\text{C}$

Details of note ① through ④ are on the last page

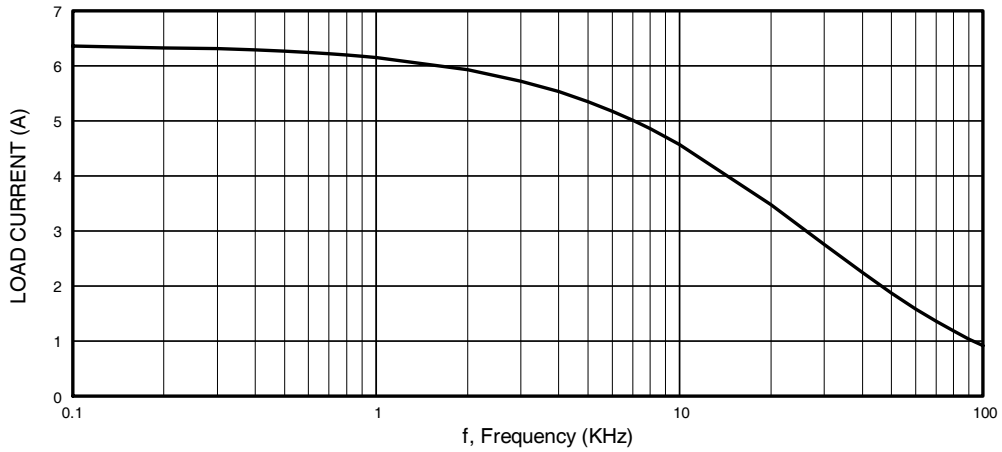

Fig. 1 - Typical Load Current vs. Frequency
 (For square wave, $I = I_{RMS}$ of fundamental; for triangular wave, $I = I_{PK}$)

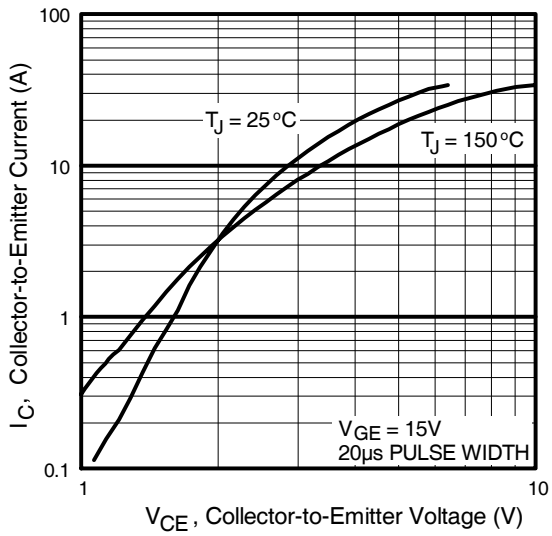

Fig. 2 - Typical Output Characteristics

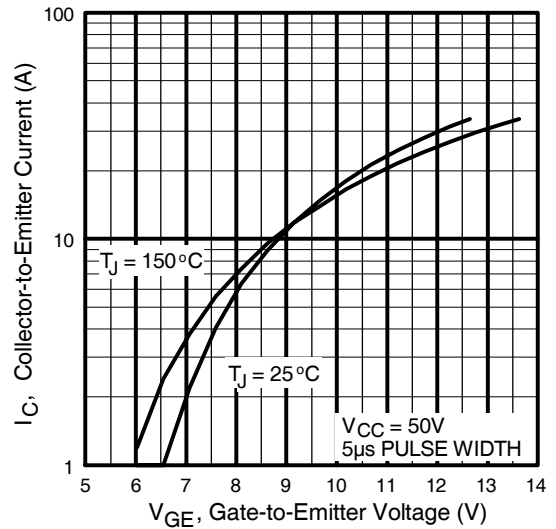

Fig. 3 - Typical Transfer Characteristics

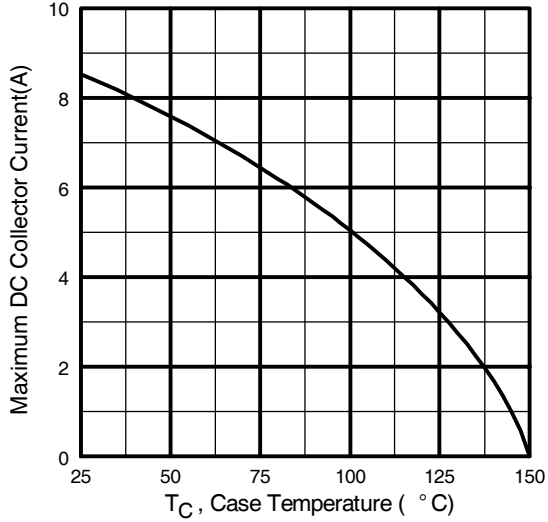

Fig. 4 - Maximum Collector Current vs. Case Temperature

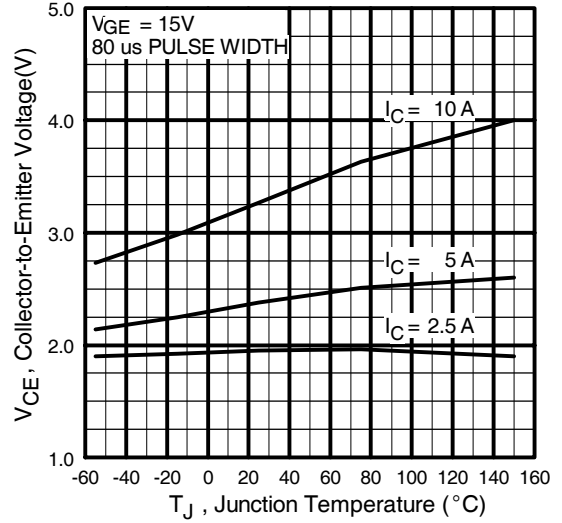

Fig. 5 - Collector-to-Emitter Voltage vs. Junction Temperature

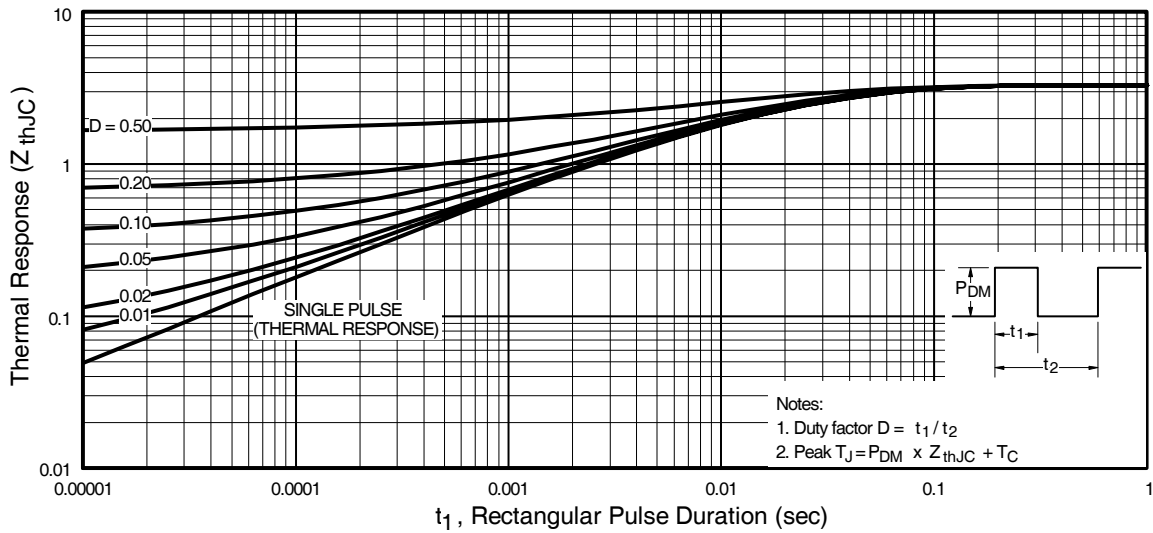

Fig. 6 - Maximum Effective Transient Thermal Impedance, Junction-to-Case

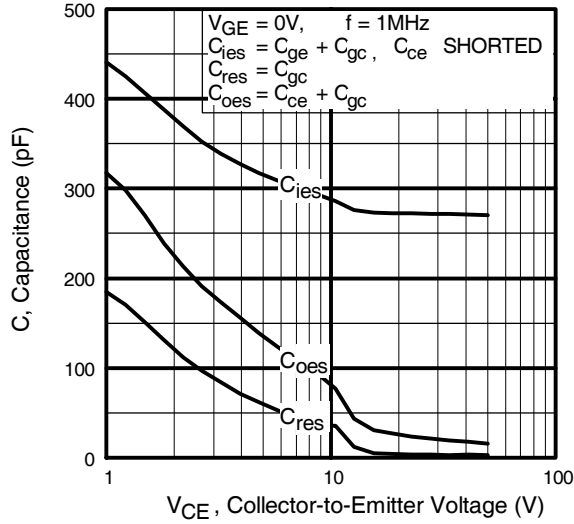

Fig. 7 - Typical Capacitance vs. Collector-to-Emitter Voltage

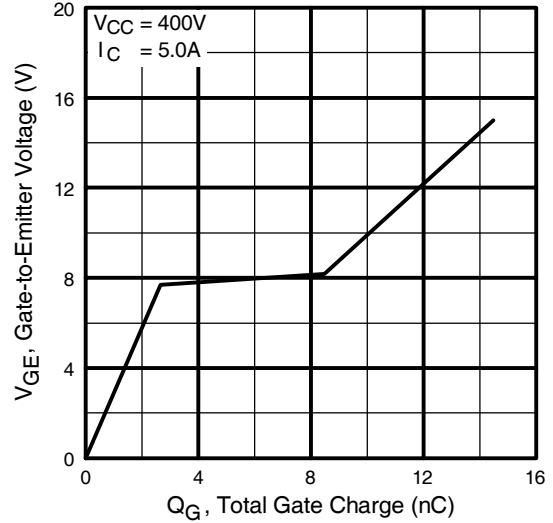

Fig. 8 - Typical Gate Charge vs. Gate-to-Emitter Voltage

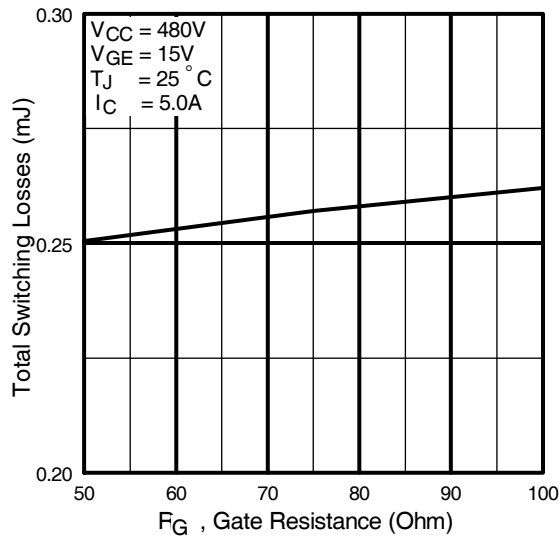

Fig. 9 - Typical Switching Losses vs. Gate Resistance

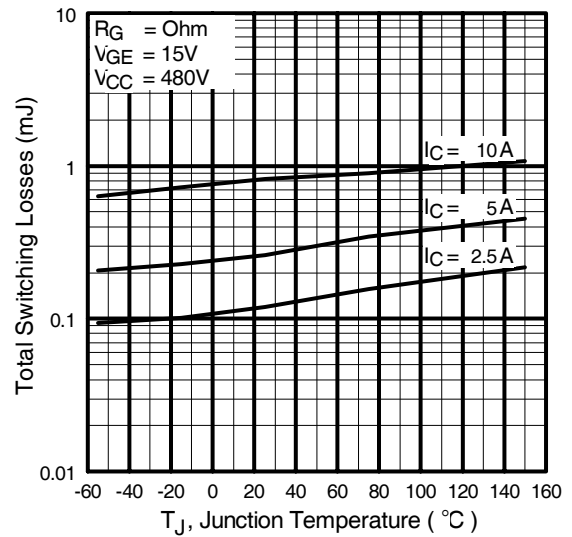

Fig. 10 - Typical Switching Losses vs. Junction Temperature

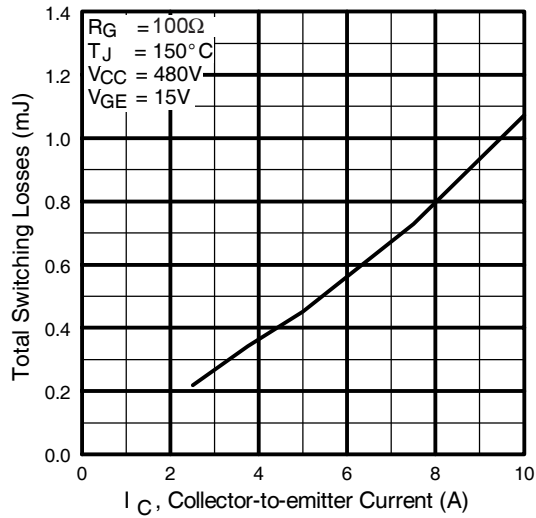

Fig. 11 - Typical Switching Losses vs. Collector-to-emitter Current

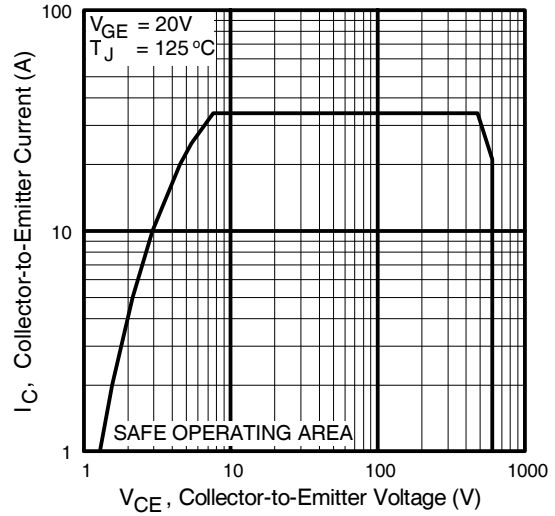

Fig. 12 - Turn-Off SOA

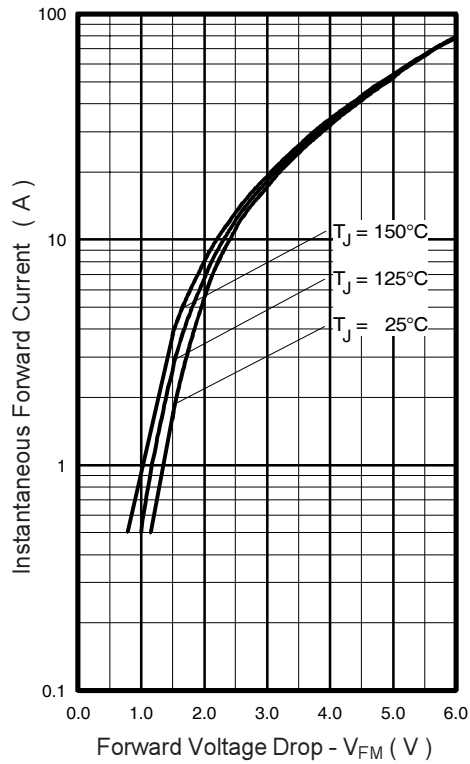

Fig. 13 - Maximum Forward Voltage Drop vs. Instantaneous Forward Current

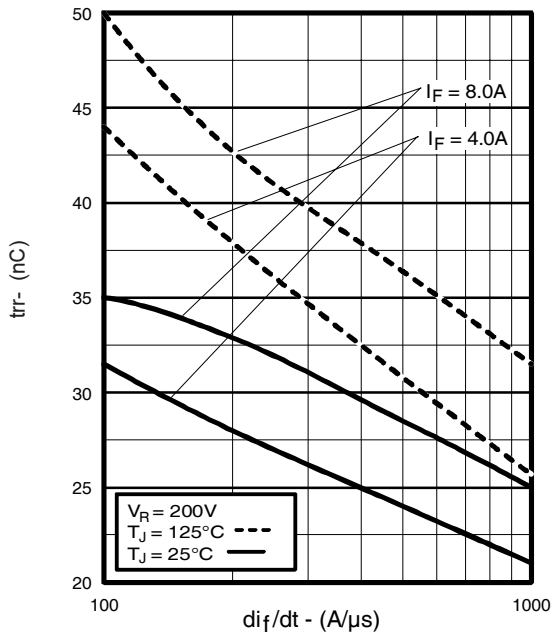

Fig. 14 - Typical Reverse Recovery vs. di_f/dt

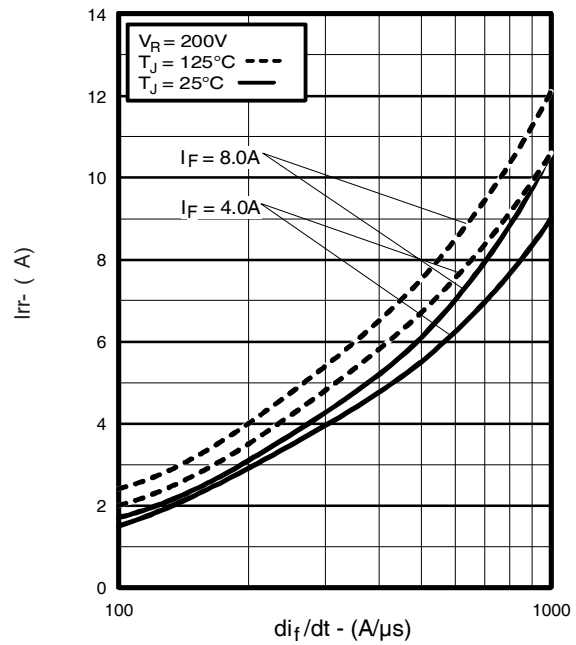

Fig. 15 - Typical Recovery Current vs. di_f/dt

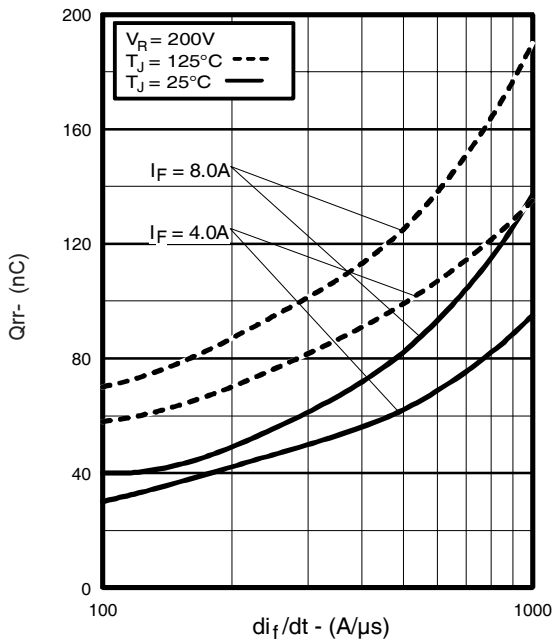

Fig. 16 - Typical Stored Charge vs. di_f/dt

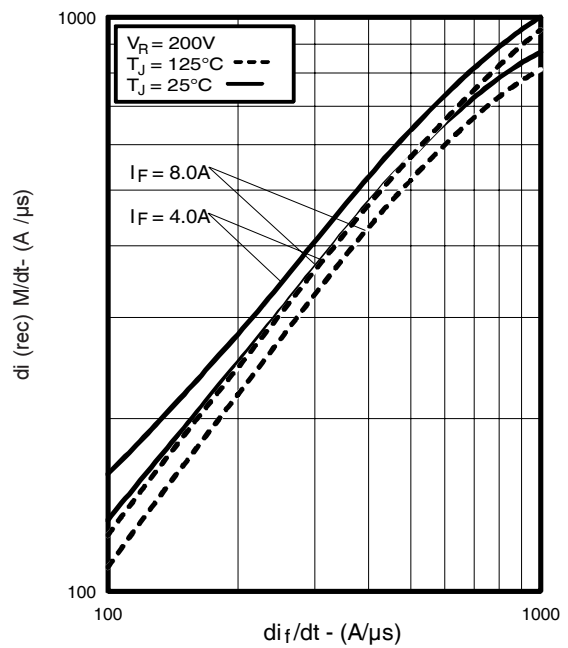

Fig. 17 - Typical $di_{(rec)M}/dt$ vs. di_f/dt ,

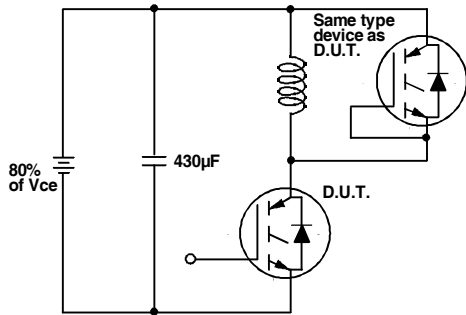

Fig. 18a - Test Circuit for Measurement of I_{LM} , E_{on} , $E_{off}(\text{diode})$, t_{rr} , Q_{rr} , I_{rr} , $t_{d(on)}$, t_r , $t_{d(off)}$, t_f

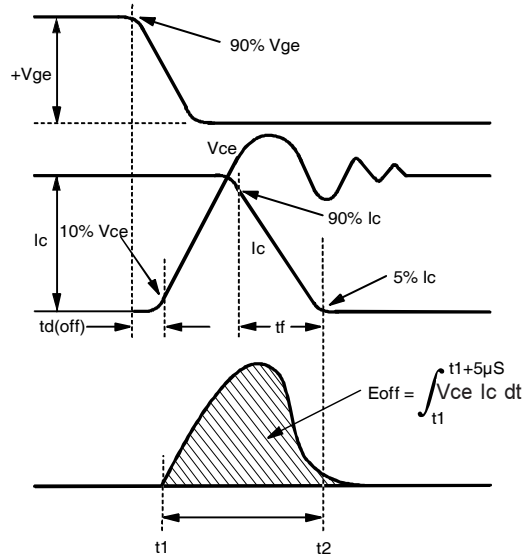

Fig. 18b - Test Waveforms for Circuit of Fig. 18a, Defining E_{off} , $t_{d(off)}$, t_f

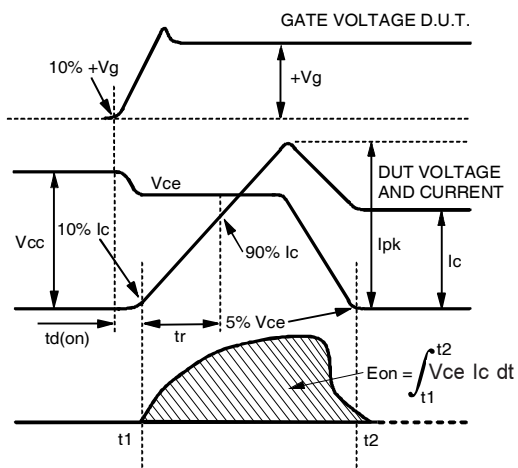

Fig. 18c - Test Waveforms for Circuit of Fig. 18a, Defining E_{on} , $t_{d(on)}$, t_r

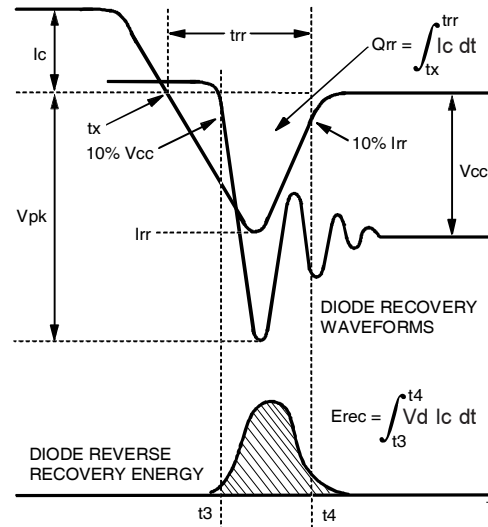

Fig. 18d - Test Waveforms for Circuit of Fig. 18a, Defining E_{rec} , t_{rr} , Q_{rr} , I_{rr}

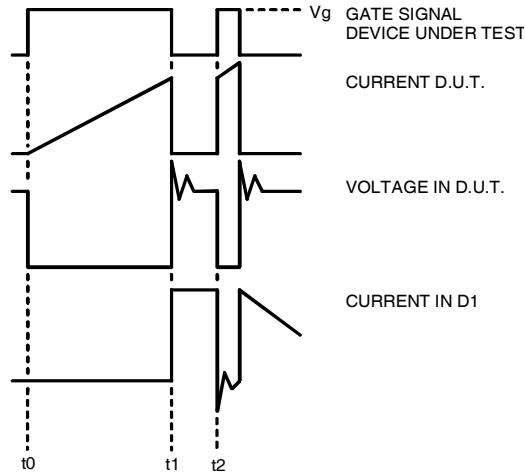

Figure 18e. Macro Waveforms for Figure 18a's Test Circuit

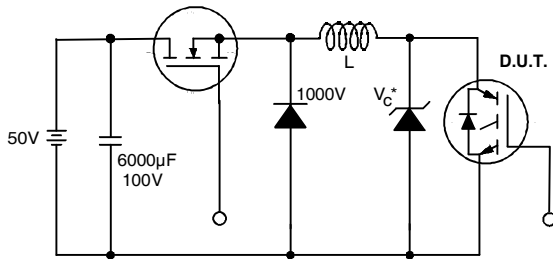

Figure 19. Clamped Inductive Load Test Circuit

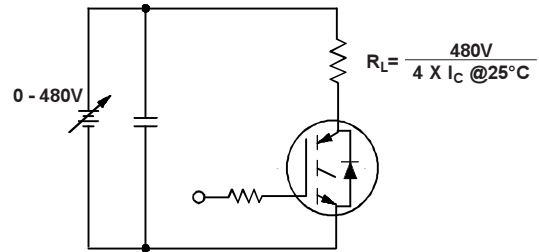
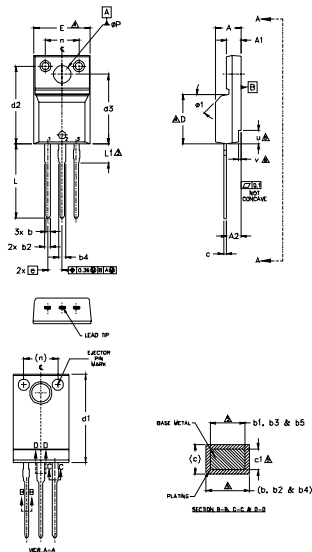

Figure 20. Pulsed Collector Current Test Circuit

IRG4IB10UDPbF

TO-220AB Full-Pak Package Outline

Dimensions are shown in millimeters (inches)



SYMBOL	DIMENSIONS				NOTES
	MILLIMETERS		INCHES		
	MIN.	MAX.	MIN.	MAX.	
A	4.57	4.83	.180	.190	1.0 DIMENSIONAL AND TOLERANCING AS PER ASME Y14.5 M-1994 2.0 DIMENSIONS ARE SHOWN IN MILLIMETERS (INCHES) 3.0 LEAD DIMENSION AND FINISH UNCONTROLLED IN L1 4.0 DIMENSION D & E DO NOT INCLUDE MOLD FLASH. MOLD FLASH SHALL NOT EXCEED .005" (0.127) PER SIDE. THESE DIMENSIONS ARE MEASURED AT THE OUTER MOST EXTREMES OF THE PLASTIC BODY. 5.0 DIMENSION d1, b5, b5 & c1 APPLY TO BASE METAL ONLY 6.0 STEP OPTIONAL ON PLASTIC BODY DEFINED BY DIMENSIONS u & v. 7.0 CONTROLLING DIMENSION - INCHES.
A1	2.57	2.83	.101	.111	
A2	2.51	2.93	.099	.115	
b	0.61	0.94	.024	.037	
b1	0.61	0.89	.024	.035	
b2	0.76	1.27	.030	.050	
b3	0.76	1.22	.030	.048	
b4	1.02	1.52	.040	.060	
b5	1.02	1.47	.040	.058	
c	0.33	0.63	.013	.025	
c1	0.33	0.58	.013	.023	
D	8.66	9.80	.341	.386	
d1	15.80	16.13	.622	.635	
d2	13.97	14.22	.550	.560	
d3	12.30	12.93	.484	.509	
E	9.63	10.75	.379	.423	
e	2.54	BSC	.100	BSC	
L	13.20	13.72	.520	.540	LEAD ASSIGNMENTS HERMET 1- GATE 2- DRAIN 3- SOURCE USE IN CAP/PADE 1- GATE 2- COLLECTOR 3- EMITTER
L1	3.37	3.67	.122	.145	
n	6.05	6.60	.238	.260	
ØP	3.05	3.45	.120	.136	
u	2.40	2.50	.094	.098	
v	0.40	0.50	.016	.020	
Ø1	-	45°	-	45°	

TO-220AB Full-Pak Part Marking Information

EXAMPLE: THIS IS AN IRF1840G
WITH ASSEMBLY
LOT CODE 3432
ASSEMBLED ON WW 24, 2001
IN THE ASSEMBLY LINE 'K'

Note: 'P' in assembly line position indicates 'Lead-Free'

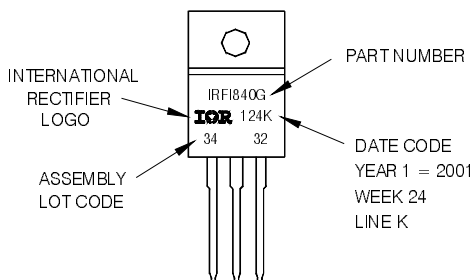

TO-220AB Full-Pak package is not recommended for Surface Mount Application.

Notes:

- ① Repetitive rating; $V_{GE} = 20V$, pulse width limited by max. junction temperature (See fig. 20).
- ② $V_{CC} = 80\%(V_{CES})$, $V_{GE} = 20V$, $L = 10\mu H$, $R_G = 100\Omega$, (See fig. 19).
- ③ Pulse width $\leq 80\mu s$; duty factor $\leq 0.1\%$.
- ④ Pulse width $5.0\mu s$, single shot.

Note: For the most current drawing please refer to IR website at <http://www.irf.com/package/>

Data and specifications subject to change without notice.