

In the box

The following components are included in the DK-S3A7 Development Kit:

- DK-S3A7 Main Board (DK-S3A7M)
- DK-S3A7 Breakout Board (DK-S3A7B)
- DK-S3A7 Segment LCD panel (DK-S3A7LCD)
- One USB Type A to Micro-B cable
- Multi-region 5V, 2.0A power supply
- Quick Start Guide (this document)

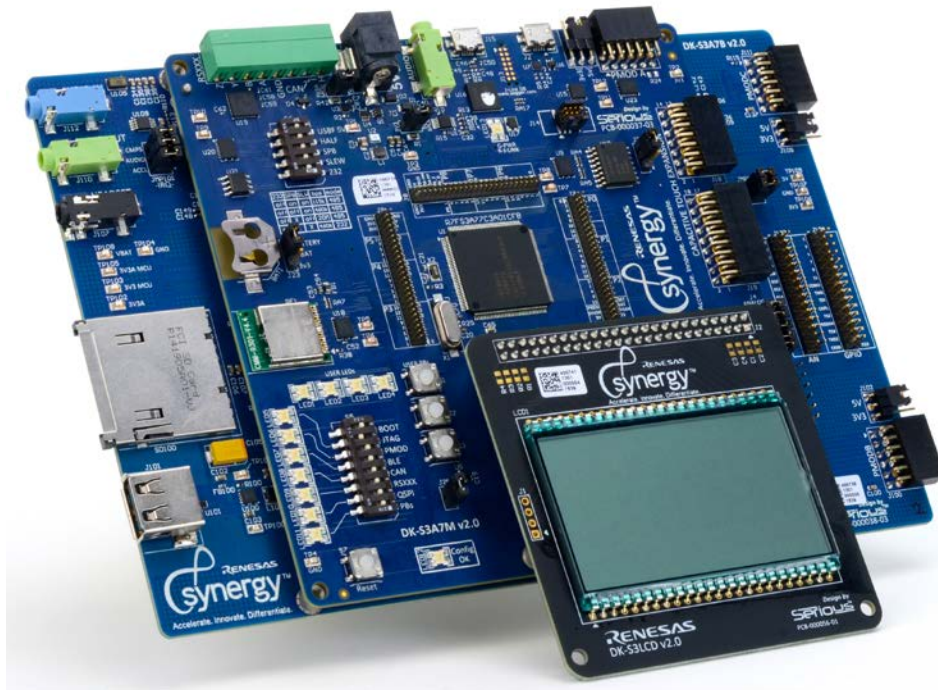

Overview

This kit and the associated development tools provide the user with a platform to develop products with the Renesas Synergy™ S3 microcontrollers. This Quick Start Guide walks you through using the out-of-box demo then provides step-by-step directions to develop, configure, generate, build, download and execute the Blinky Project on the Renesas Synergy™ Software Package (SSP).

DK-S3A7 Kit

NOTE: This Quick Start Guide is for the DK-S3A7 Development Kit.

Prerequisites

Required software and tools

- Minimum workstation requirements: Microsoft® Windows® 7 with Intel® Core™ family processor running at 2.0 GHz or higher (or equivalent processor), 8 GB memory, 250 GB hard disk or SSD, USB 2.0, Internet connection
- Renesas e² studio Integrated Solution Development Environment (ISDE)
- Renesas Synergy™ Software Package (SSP)

Installation

Tools are available for download at: <https://synergygallery.renesas.com>.

NOTE: Version numbers of the tools may change. Following we show the versions that were available when this document was developed.

Download and install the latest revision of the e² studio (ISDE) as follows:

NOTE: Unless informed otherwise in the following steps, use the default options.

- 1) In the e² studio Setup dialog, select at least the **Renesas Synergy™** Device Family when the following dialog box appears.

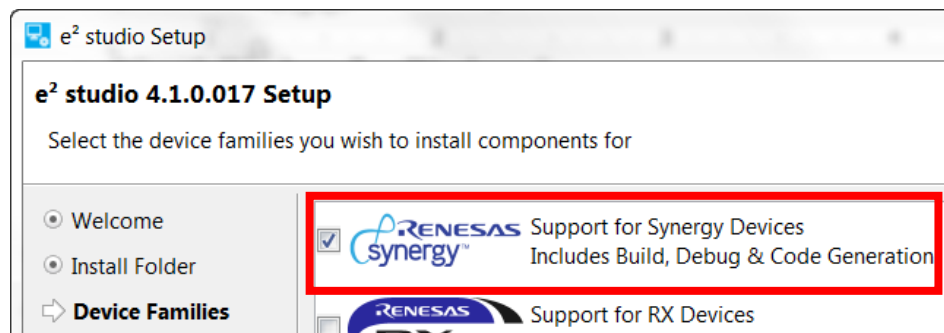

- 2) Select the additional software **GCC ARM Embedded 4.8.2014q3** when the following dialog box appears:

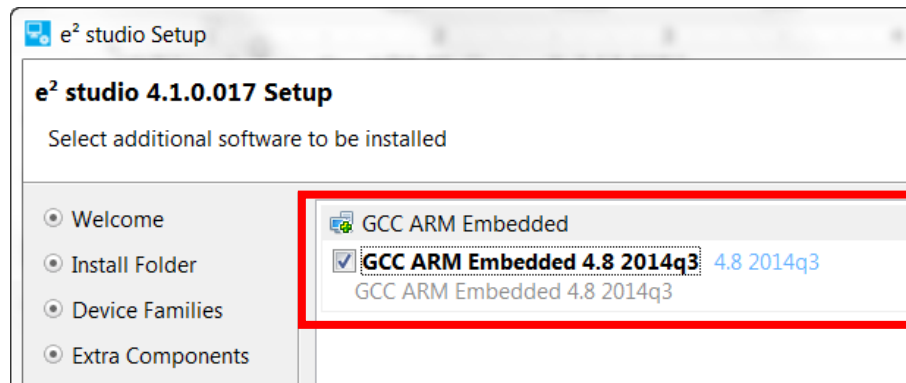

- 3) Download and install the latest revision of the SSP using the default options.

Connecting the board components

To power the boards and connect the boards to the PC, follow these steps:

- 1) Set the JTAG DIP switch 7 on S5 to ON, toward the LEDs.

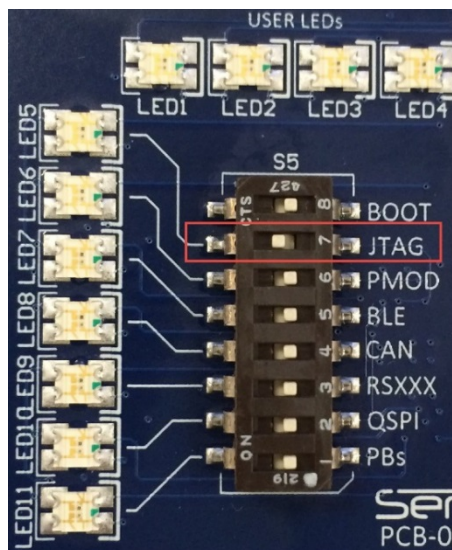

- Using the power supply provided with the DK-S3A7 kit, apply power through the 5V barrel connector (J1) on the Main Board.

LED13 turns green with a flashing red beside it. The solid green and flashing red LED13 means that the kit cannot communicate with the PC on the debug port. This is normal.

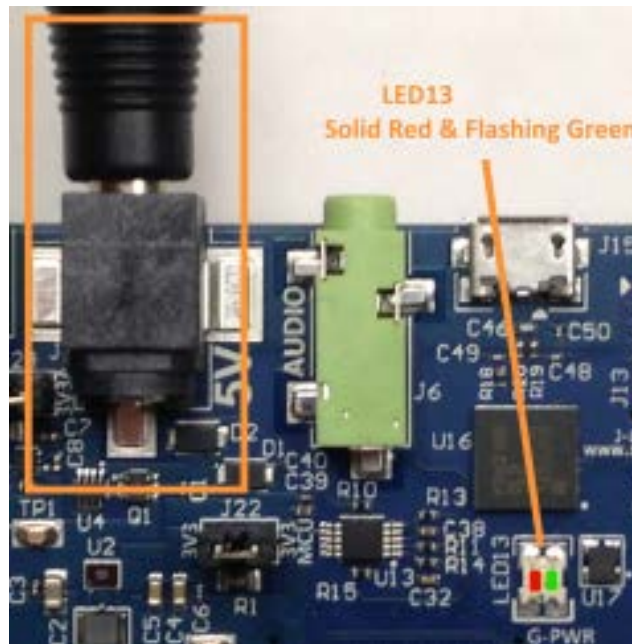

- Connect the USB cable provided with the DK-S3A7 to the J-Link OB (J15) on the Main Board.

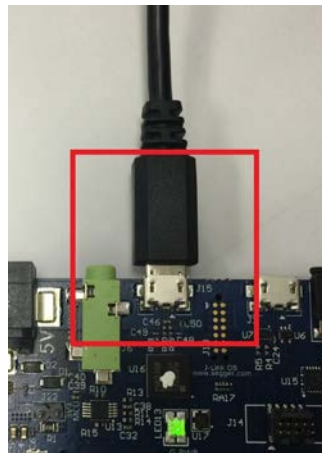

- Connect the other end of the USB cable to a USB port of the workstation.

Now, LED13 turns green with no flashing red. This indicates a good connection.

Running the Out-of-Box Demo

The Out-of-Box Demo starts by flashing the Configuration (Light Scale) and USER LEDs for about 6 seconds. It then turns on and off all segments of the segment LCD. This is actually a configuration test that is verifying performance of the hardware. If a problem is found, then USER LED 1 and 2 are red. If no problems exist, then USER LED 3 and 4 are green.

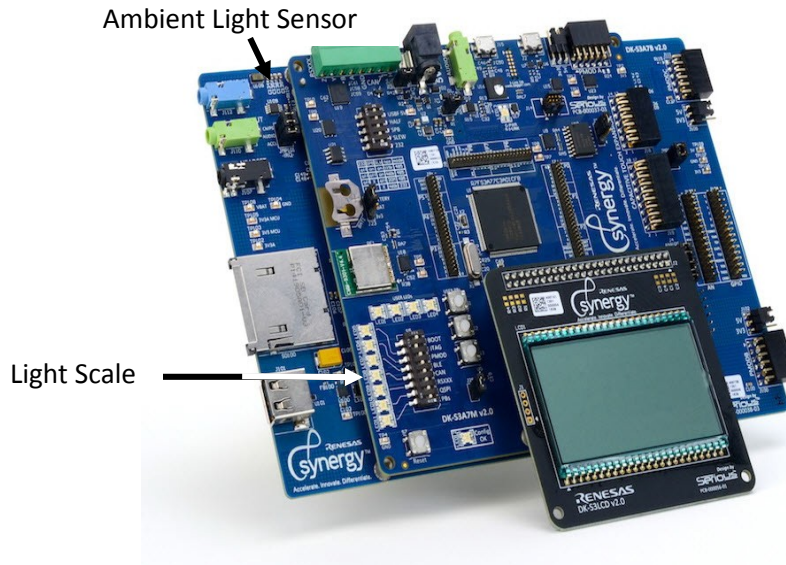

After about 12 seconds, the S3 MCU starts sensing the amount of light at the Ambient Light Sensor, U105. The Demo takes the A/D reading and uses it to display a Light Scale on the Configuration LEDs and as a battery level and digital count on the segment LCD. The elapsed time of the Demo is also shown on the segment LCD.

Do the following steps:

- 1) Move a light source closer and farther from the Ambient Light Sensor and observe the LEDs and LCD values.
- 2) When the light sensors output reaches or exceeds their maximum value, the MCU flashes the LCD cycles on and off quickly.

Running the Blinky Project

The Blinky Project in the SSP provides a simple example of an SSP application and familiarizes you with the e2 studio environment. Before running the project, ensure that the J-Link On-Board is connected to the workstation. See the steps in *Connecting the board components* on page 3.

To run the Blinky Project, first create a Renesas Synergy Project in the e² studio ISDE. You can then debug and run the project on the DK-S3A7.

Creating the Blinky Project

To create a project, do the following steps:

- 1) Start the e² studio ISDE by clicking **Start Menu > Renesas Electronics e2studio > e2 studio**.

NOTES:

- The e² studio ISDE confirms the installed tool chain(s) the first time it is started after installing the toolchains.
 - The e² studio ISDE displays the **Welcome to e² studio** screen by default. If you click the [X], it does not display again.
 - If you do not have a compatible tool chain installed, see *Prerequisites* on page 2.
- 2) If the **Workspace Launcher** dialog box displays, click **OK**.

NOTE: If you select **Use this as the default (workspace) and do not ask again**, the **Workspace Launcher** window does not display.

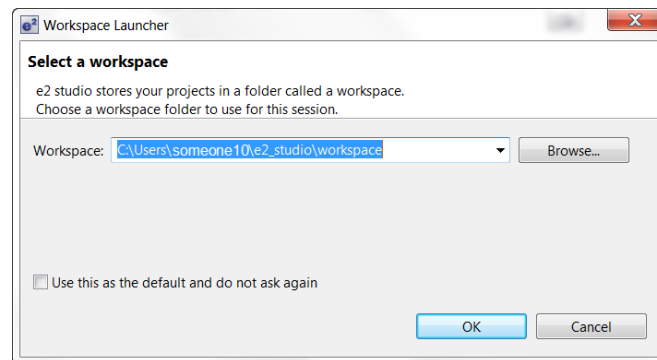

- 3) Start a new Synergy Project by clicking **File > New > Synergy Project**.

The ISDE displays the **Project Configuration (Synergy Project)** dialog box:

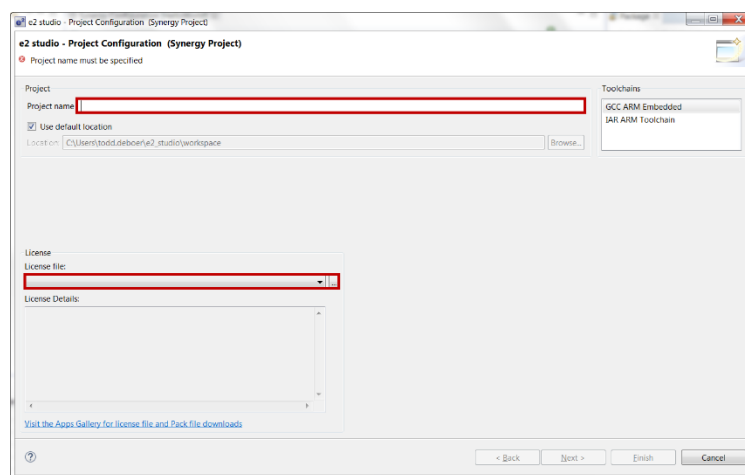

- 4) Enter **Blinky_DK_S3A7** as the **Project name**.

- 5) The first time you configure a project you need to load a license file. Click the browse icon of the **License File** field and, if needed and you installed to the default locations, browse to `C:\Renesas\e2_studio\internal\projectgen\arm\Licenses\`.

NOTE: After you have loaded the license file, it is loaded and displayed in the **License** window by default.

- 6) Click **Next**.

The ISDE displays the **Project Configuration (Synergy Project)** window with the **Board** options.

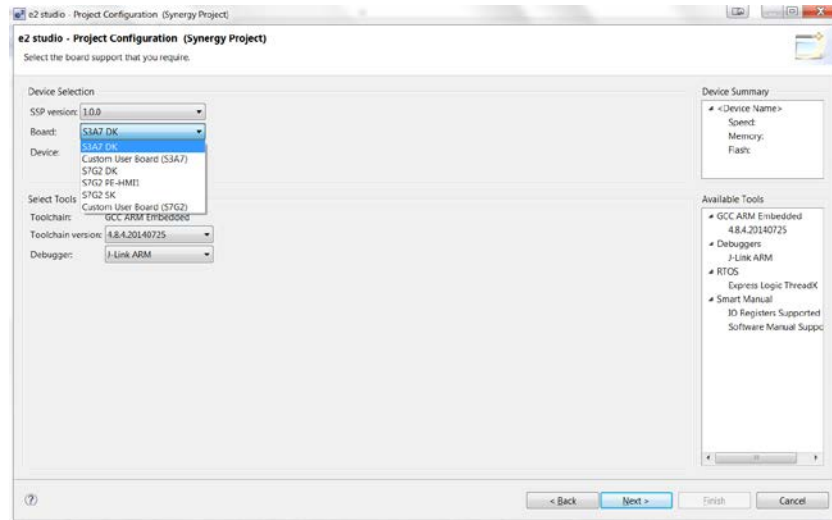

- 7) Select **S3A7 DK** and leave all other options at their default settings.

- 8) Click **Next**.

The ISDE displays the **Project Configuration (Synergy Project)** window with the **Project Template Selection** options.

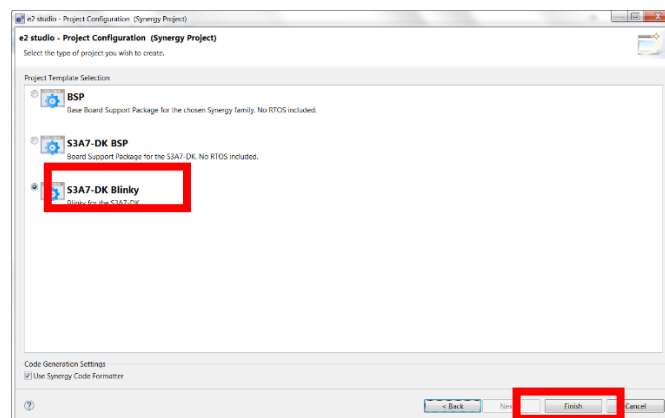

- 9) Select **S3A7-DK Blinky**.

- 10) Click **Finish**.

11) If the **Open Associated Perspective** dialog box appears, click **Yes**.

NOTE: The e² studio ISDE has built in Perspectives. Until you inform the tool to **Remember my decision**, it asks if it can use the **Synergy Configuration perspective**:

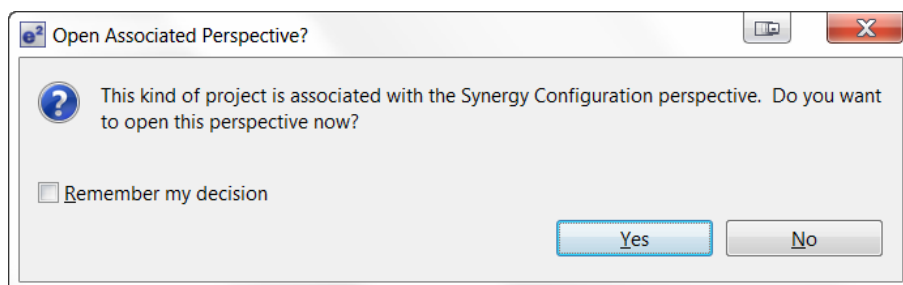

The ISDE automatically configures the SSP to load and generate the necessary configuration files for the microcontroller hardware associated with the selected board.

The ISDE displays the **Synergy Project Editor** where you can see all generated files and configurations by selecting the **Clocks**, **Pins**, **Threads**, **ICU**, and **Components** tabs.

NOTE: Do try different things. **Edit > Undo** reverses almost any action you most recently performed.

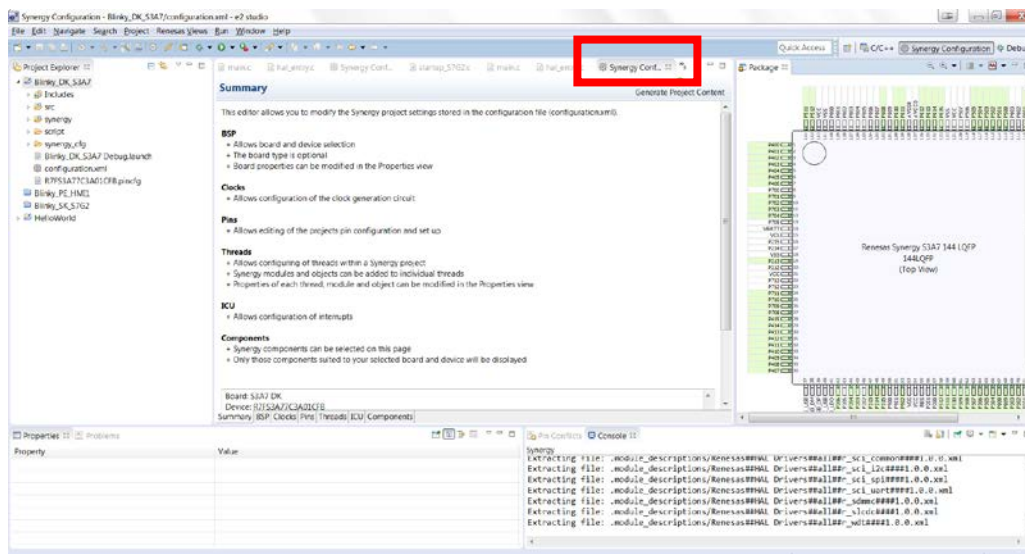

12) Generate the project content by clicking  **Generate Project Content**.

13) Build the project by clicking **Project > Build Project** or clicking on the Build icon, .

Debugging and running the Blinky Project

To debug and run the project, do the following steps:

- 1) Configure the debugger by selecting the drop-down menu next to the debug icon and select **Debug Configurations**:

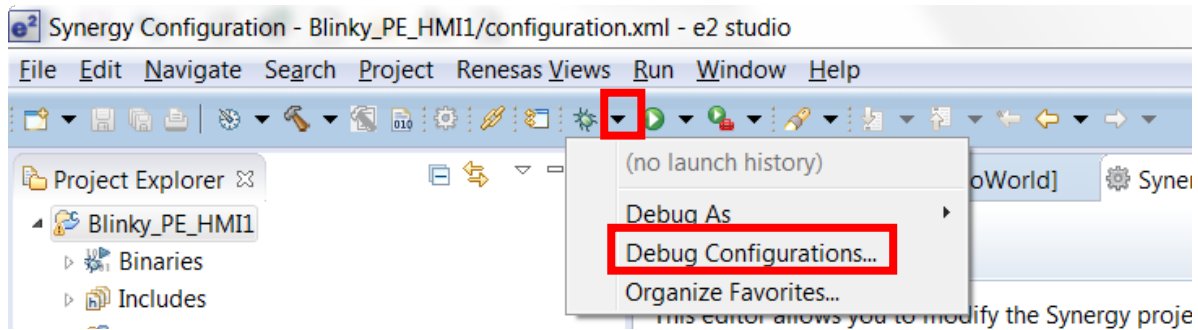

- 2) On the **Debug Configurations** dialog, select **Renesas GDB Hardware Debugging > Blinky_DK_S3A7 Debug**.

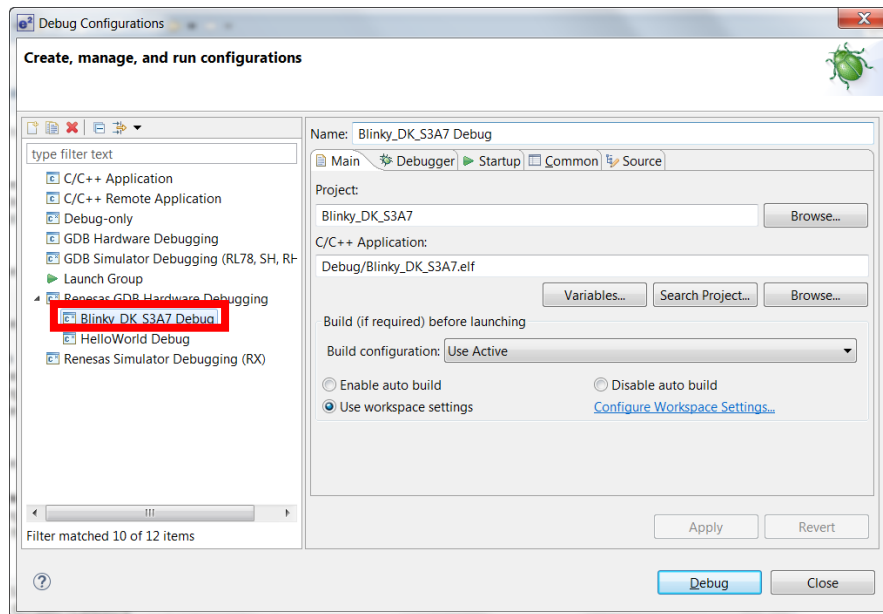

3) Click **Debug**.

- a. If the **Confirm Perspective Switch** dialog displays, click **Yes**.

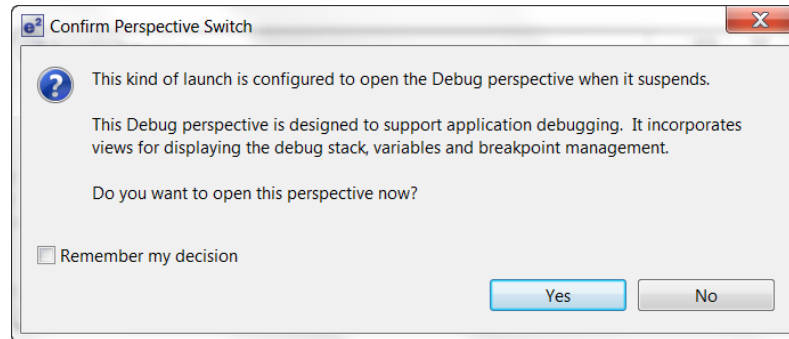

NOTE: If you click the **Remember my decision** check box before clicking **Yes**, you will not see this dialog again.

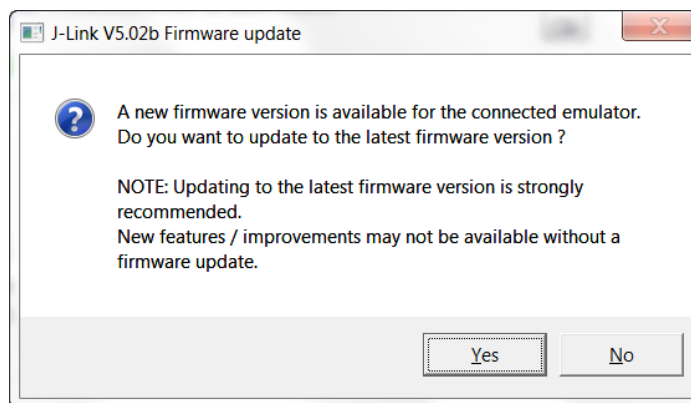

- b. If the **J-Link Firmware update** dialog displays, we highly recommend that you click **Yes**.



The ISDE downloads the project onto the board.

- 4) Click on the Resume icon,  and the software runs until `hal_entry ()`.
- 5) Click on the Resume icon, , and the software runs turning LED1 on and off.

Next steps

You can review the code for the Blinky Project in the src directory of your project:

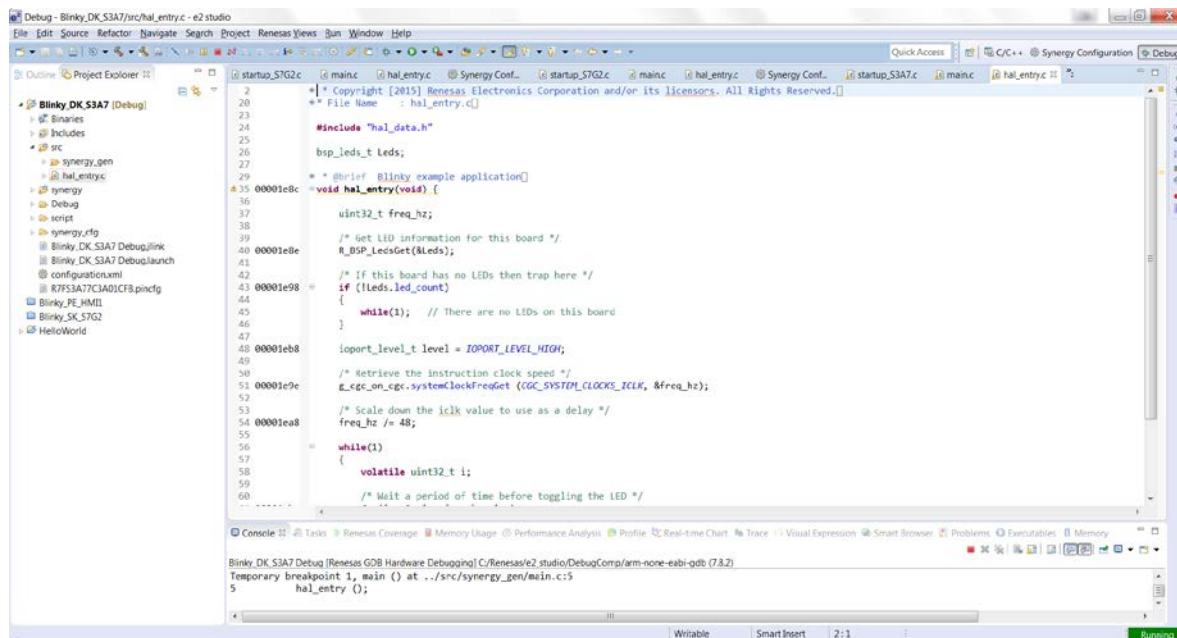

Application Notes and Demonstration Applications are available from <https://synergygallery.renesas.com/ssp>.

Examples of the categories that Renesas is developing are:

- Wired connectivity (CAN, RS232/485, TCP/IP, Web Server, networking services)
- Bluetooth connectivity (Bluetooth Classic and Bluetooth Low Energy connection to mobile devices using various profiles)
- WiFi connectivity (Access Point Enumeration, Access Point connection using secure protocols, TCP/IP, Web Server, networking services)
- Multi-media (webcam, audio playback & record, audio processing, GUIX tutorials)
- MCU performance & power measurement (thread, throughput, and I/O performance, low-power modes & power measurement)
- Security (protected memory and bus access examples, stack security examples, security protocols and services examples)

Reloading the Out-of-Box Demo

Should you desire to reload the original Out-of-Box Demo application, you can find it and the instructions to reload it from <https://synergygallery.renesas.com/ssp>.

NOTE: The Out-of-Box Demo on the Synergy Gallery may be an updated and improved demo. This kit contains version 1.0 of the DK-S3A7 Out-of-Box Demo.

Support

Support: <https://synergygallery.renesas.com/support>

Technical contact details:

- America: https://renesas.zendesk.com/anonymous_requests/new
- Europe: <http://www.renesas.eu/support/index.jsp>
- Japan: <http://japan.renesas.com/contact/index.jsp>

Notice

1. Descriptions of circuits, software and other related information in this document are provided only to illustrate the operation of semiconductor products and application examples. You are fully responsible for the incorporation of these circuits, software, and information in the design of your equipment. Renesas Electronics assumes no responsibility for any losses incurred by you or third parties arising from the use of these circuits, software, or information.
2. Renesas Electronics has used reasonable care in preparing the information included in this document, but Renesas Electronics does not warrant that such information is error free. Renesas Electronics assumes no liability whatsoever for any damages incurred by you resulting from errors in or omissions from the information included herein.
3. Renesas Electronics does not assume any liability for infringement of patents, copyrights, or other intellectual property rights of third parties by or arising from the use of Renesas Electronics products or technical information described in this document. No license, express, implied or otherwise, is granted hereby under any patents, copyrights or other intellectual property rights of Renesas Electronics or others.
4. You should not alter, modify, copy, or otherwise misappropriate any Renesas Electronics product, whether in whole or in part. Renesas Electronics assumes no responsibility for any losses incurred by you or third parties arising from such alteration, modification, copy or otherwise misappropriation of Renesas Electronics product.
5. Renesas Electronics products are classified according to the following two quality grades: "Standard" and "High Quality". The recommended applications for each Renesas Electronics product depends on the product's quality grade, as indicated below.
"Standard": Computers; office equipment; communications equipment; test and measurement equipment; audio and visual equipment; home electronic appliances; machine tools; personal electronic equipment; and industrial robots etc.
"High Quality": Transportation equipment (automobiles, trains, ships, etc.); traffic control systems; anti-disaster systems; anti-crime systems; and safety equipment etc.
Renesas Electronics products are neither intended nor authorized for use in products or systems that may pose a direct threat to human life or bodily injury (artificial life support devices or systems, surgical implantations etc.), or may cause serious property damages (nuclear reactor control systems, military equipment etc.). You must check the quality grade of each Renesas Electronics product before using it in a particular application. You may not use any Renesas Electronics product for any application for which it is not intended. Renesas Electronics shall not be in any way liable for any damages or losses incurred by you or third parties arising from the use of any Renesas Electronics product for which the product is not intended by Renesas Electronics.
6. You should use the Renesas Electronics products described in this document within the range specified by Renesas Electronics, especially with respect to the maximum rating, operating supply voltage range, movement power voltage range, heat radiation characteristics, installation and other product characteristics. Renesas Electronics shall have no liability for malfunctions or damages arising out of the use of Renesas Electronics products beyond such specified ranges.
7. Although Renesas Electronics endeavors to improve the quality and reliability of its products, semiconductor products have specific characteristics such as the occurrence of failure at a certain rate and malfunctions under certain use conditions. Further, Renesas Electronics products are not subject to radiation resistance design. Please be sure to implement safety measures to guard them against the possibility of physical injury, and injury or damage caused by fire in the event of the failure of a Renesas Electronics product, such as safety design for hardware and software including but not limited to redundancy, fire control and malfunction prevention, appropriate treatment for aging degradation or any other appropriate measures. Because the evaluation of microcomputer software alone is very difficult, please evaluate the safety of the final products or systems manufactured by you.
8. Please contact a Renesas Electronics sales office for details as to environmental matters such as the environmental compatibility of each Renesas Electronics product. Please use Renesas Electronics products in compliance with all applicable laws and regulations that regulate the inclusion or use of controlled substances, including without limitation, the EU RoHS Directive. Renesas Electronics assumes no liability for damages or losses occurring as a result of your noncompliance with applicable laws and regulations.
9. Renesas Electronics products and technology may not be used for or incorporated into any products or systems whose manufacture, use, or sale is prohibited under any applicable domestic or foreign laws or regulations. You should not use Renesas Electronics products or technology described in this document for any purpose relating to military applications or use by the military, including but not limited to the development of weapons of mass destruction. When exporting the Renesas Electronics products or technology described in this document, you should comply with the applicable export control laws and regulations and follow the procedures required by such laws and regulations.
10. It is the responsibility of the buyer or distributor of Renesas Electronics products, who distributes, disposes of, or otherwise places the product with a third party, to notify such third party in advance of the contents and conditions set forth in this document, Renesas Electronics assumes no responsibility for any losses incurred by you or third parties as a result of unauthorized use of Renesas Electronics products.
11. This document may not be reproduced or duplicated in any form, in whole or in part, without prior written consent of Renesas Electronics.
12. Please contact a Renesas Electronics sales office if you have any questions regarding the information contained in this document or Renesas Electronics products, or if you have any other inquiries.

(Note 1) "Renesas Electronics" as used in this document means Renesas Electronics Corporation and also includes its majority-owned subsidiaries.

(Note 2) "Renesas Electronics product(s)" means any product developed or manufactured by or for Renesas Electronics.



SALES OFFICES

Renesas Electronics Corporation

<http://www.renesas.com>

Refer to "<http://www.renesas.com/>" for the latest and detailed information.

Renesas Electronics America Inc.

2801 Scott Boulevard Santa Clara, CA 95050-2549, U.S.A.
Tel: +1-408-588-6000, Fax: +1-408-588-6130

Renesas Electronics Canada Limited

9251 Yonge Street, Suite 8309 Richmond Hill, Ontario Canada L4C 9T3
Tel: +1-905-237-2004

Renesas Electronics Europe Limited

Dukes Meadow, Millboard Road, Bourne End, Buckinghamshire, SL8 5FH, U.K.
Tel: +44-1628-585-100, Fax: +44-1628-585-900

Renesas Electronics Europe GmbH

Arcadiastrasse 10, 40472 Düsseldorf, Germany
Tel: +49-211-6503-0, Fax: +49-211-6503-1327

Renesas Electronics (China) Co., Ltd.

Room 1709, Quantum Plaza, No.27 ZhiChunLu Haidian District, Beijing 100191, P.R.China
Tel: +86-10-8235-1155, Fax: +86-10-8235-7679

Renesas Electronics (Shanghai) Co., Ltd.

Unit 301, Tower A, Central Towers, 555 Langao Road, Putuo District, Shanghai, P. R. China 200333
Tel: +86-21-2226-0888, Fax: +86-21-2226-0999

Renesas Electronics Hong Kong Limited

Unit 1601-1611, 16/F., Tower 2, Grand Century Place, 193 Prince Edward Road West, Mongkok, Kowloon, Hong Kong
Tel: +852-2265-6688, Fax: +852 2886-9022

Renesas Electronics Taiwan Co., Ltd.

13F, No. 363, Fu Shing North Road, Taipei 10543, Taiwan
Tel: +886-2-8175-9600, Fax: +886 2-8175-9670

Renesas Electronics Singapore Pte. Ltd.

80 Bendemeer Road, Unit #06-02 Hyflux Innovation Centre, Singapore 339949
Tel: +65-6213-0200, Fax: +65-6213-0300

Renesas Electronics Malaysia Sdn.Bhd.

Unit 1207, Block B, Menara Amcorp, Amcorp Trade Centre, No. 18, Jln Persiaran Barat, 46050 Petaling Jaya, Selangor Darul Ehsan, Malaysia
Tel: +60-3-7955-9390, Fax: +60-3-7955-9510

Renesas Electronics India Pvt. Ltd.

No.77C, 100 Feet Road, HAL II Stage, Indiranagar, Bangalore, India
Tel: +91-80-67208700, Fax: +91-80-67208777

Renesas Electronics Korea Co., Ltd.

12F., 234 Teheran-ro, Gangnam-Gu, Seoul, 135-080, Korea
Tel: +82-2-558-3737, Fax: +82-2-558-5141