

ARTESYN LCC250

250 Watts Convection/Conduction Mounting



Advanced Energy's Artesyn LCC250 AC-DC power supply is a fully-enclosed conduction cooled series delivering full useable power at high temperatures. The LCC250 series, with IP64 protection against the ingress of dust and water, is ideal for applications such as outdoor signage and telecom installation like antenna and base station equipment. The power supplies are equally suitable for indoor use, such as in control consoles, indoor signage and desktops for medical applications, where the absence of cooling fans can help minimize dust and noise.

[Data Sheet](#)

Total Power:

250 W

of Outputs:

Single

Outputs:

12, 24, 48 V

SPECIAL FEATURES

- 250 W full power at elevated temperatures
- Wide operating temperature range suited for outdoor application
- IP64 rated
- Conduction-cooled or convection
- Differential remote sense
- Output adjust
- Output On/Off (Positive or Negative logic user selectable)

COMPLIANCE

- EMI Class B
- EN61000 Immunity
- MIL-STD-461E: CE101; CE102; CS101; CS114

SAFETY⁵

- UL + CSA 62368-1 2nd Ed. ANSI ES60601-1 3rd Ed
- TÜV 62368-1 2nd Ed. 60601-1 3rd Ed. 61347-1; 2-13
- CB Scheme IEC 62368-1 IEC 60950-1 2nd Ed IEC 61347-1; 2-13 IEC 60601-1
- China CCC
- CE Mark

ELECTRICAL SPECIFICATIONS

Input		
Input range	90 - 264 Vac (Operating) 115/230 Vac (Nominal)	
Frequency	47 - 63 Hz	
Input fusing	Internal fuse on both L and N lines	
Inrush current	50 A	
Power factor	> 0.92 Full load	
Harmonics	Meets EN61000-3-2; MIL-STD-461E(6); CE101; CE102; CS101; CS104	
Input current	3.4 A @ 90 Vac full load	
Hold up time	16 ms minimum at 115 Vac; 100% load	
Efficiency	230 Vac; 100% load 12 V - 89% typical 24 V - 91% typical 48 V - 91.5% typical	
Leakage current	< 275 μ A at 230 Vac	
Output		
Output rating	12 V @ 20.8 A 24 V @ 10.4 A 48 V @ 5.2 A	
Set point	\pm 0.2%	Factory set point
Total regulation range	\pm 2%	Line/Load/Temperature
Rated load	250 W maximum	
Minimum load	0 A Load	No loss of regulation
Capacitive load	0 - 330 μ F/Amp	
Output voltage overshoot		No overshoot/undershoot outside the regulation band during on or off cycle
Constant output voltage adjustment range	12 V: +10 / -10% 24 V: +14.6 / -15% 48 V: +15% / -15%	Adjust via VR2
Constant output current adjustment range	+0 / -50%	Adjust via VR1 CC mode supported from Vo nominal down to 80% Vo
Output ripple and noise	1%	0 to 330 μ F/Amp
Transient response	\pm 5% Vo max transient; recovery < 500 μ s max	50% Load Step @ 1 A/ μ s Step Load verified at: 50% to 100% Load; 90 - 264 Vac input; Capacitive load from 0 to 330 μ F/Amp
Remote sense	Capable of Stable Offset of \pm 0.5 Vdc at output cable termination	+SENSE (Red Wire); -SENSE (Black Wire)
Output On/Off	Remote On/Off referenced to secondary side. Positive or Negative logic user selectable via CN2. Factory default is Positive logic	On/Off (Orange Wire); On/Off Return (White Wire)
Overcurrent protection (OCP)	\leq 150% Io	Auto-recovery
Overvoltage protection (OVP)	110% to 135% Vo	Latching mode; Requires input AC recycle
Overtemperature protection (OTP)		Auto-recovery; hiccup mode
Output isolation	3000 Vac Input to Output 1500 Vac Input to Ground 500 Vac Output to Ground	

ENVIRONMENTAL SPECIFICATIONS

Operating temperature	Suffix 4P (Conduction): -40 °C to +85 °C Baseplate Temperature Suffix 7P (Convection): -40 °C to +85 °C Ambient Temperature
Storage temperature	-40 °C to +85 °C
Humidity	10% to 100% (Condensing & Non-Condensing)
Altitude	Operating: 13,000 feet Non-Operating: 50,000 feet
Shock	IEC68-2-27
Vibration	IEC68-2-6 / IEC721-3-2
Ingress protection	IP64 Rated
MTBF (calculated)	> 780,000 hours at 100% load; Low line; Telcordia SR-332

ORDERING INFORMATION

Model Number	Output	Adjustment Range	Output Current		Output Ripple P/P ¹	Line/ Load Regulation
			Min	Max		
LCC250-12U-4P	12 V	±10%	0 A	20.8 A	1% 2	±2%
LCC250-12U-4PE	12 V	±10%	0 A	20.8 A	1% 2	±2%
LCC250-12U-7P	12 V	±10%	0 A	20.8 A	1% 2	±2%
LCC250-12U-7PE	12 V	±10%	0 A	20.8 A	1% 2	±2%
LCC250-24U-4P	24 V	+14.6 / -15%	0 A	10.4 A	1% 3	±2%
LCC250-24U-4PE	24 V	+14.6 / -15%	0 A	10.4 A	1% 3	±2%
LCC250-24U-7P	24 V	+14.6 / -15%	0 A	10.4 A	1% 3	±2%
LCC250-24U-7PE	24 V	+14.6 / -15%	0 A	10.4 A	1% 3	±2%
LCC250-48U-4P	48 V	±15%	0 A	5.2 A	1% 4	±2%
LCC250-48U-4PE	48 V	±15%	0 A	5.2 A	1% 4	±2%
LCC250-48U-7P	48 V	±15%	0 A	5.2 A	1% 4	±2%

ORDERING INFORMATION (CONTINUED)

1. Output ripple measured at the end of the output cable terminated with 10 μ F tantalum cap in parallel with 0.1 μ F ceramic capacitor.
2. 12 V: 1% limit is achieved with 2X 820 μ F/16 V external cap (e.g. PLG1C821MDO1 from Nichicon or equivalent). Otherwise, maximum limits are 1.5% at $T_a \geq 0$ °C and 2.0% max at $T_a < 0$ °C.
3. 24 V: 1% limit is achieved with 2X 820 μ F/35 V external cap (e.g. UPM1V821MHD1TO from Nichicon or equivalent). Otherwise, maximum limits are 1.5% at $T_a \geq -10$ °C. 2.0% max ripple at $T_a < -10$ °C is met with below external capacitance:

Ambient Temperature (°C)	-20	-25	-30	-35	-40
Recommended External Capacitors (μ F)	1000	2200	3300	12000	22000

4. 48 V: 1% limit is achieved with 3X 470 μ F/63 V external cap. Otherwise, maximum limits are 1.5% max at $T_a \geq 0$ °C and 2% max at $T_a < 0$ °C.
5. Two (2) LCC250 model numbers exist with same electrical performance except for safety approvals as shown below:
 - LCC250-XXu-xPE version = Europe/USA/China safety approved & carries CE/TUV, cUL, & CCC logos
 - LCC250-XXu-xP version = Europe/USA safety approved & carries CE/TÜV & cUL logos
6. 12 V unit requires external filtering for MIL-STD-461E compliance. Consult Artesyn Technical Support.
7. Warranty: 2 years

ORDERING INFORMATION (CONTINUED)

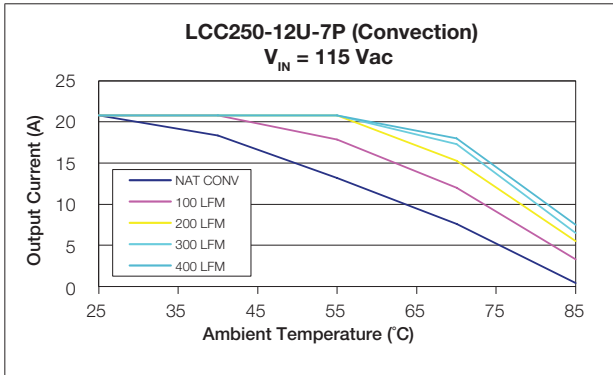

Fig 1. 12 V “4P” Suffix (Conduction) Output Current Derating

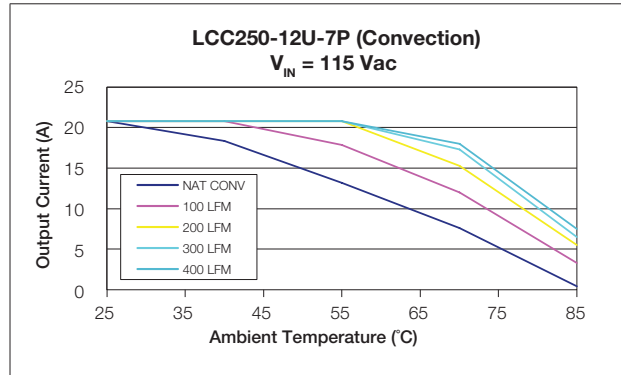

Fig 2. 12 V “7P” Suffix (Convection) Output Current Derating at 115 Vac

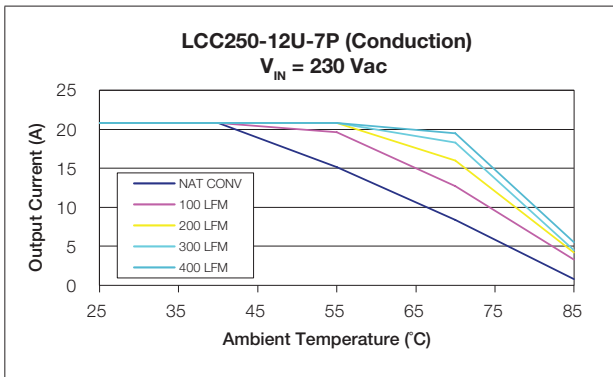

Fig 3. 12 V “7P” Suffix (Convection) Output Current Derating at 230 Vac

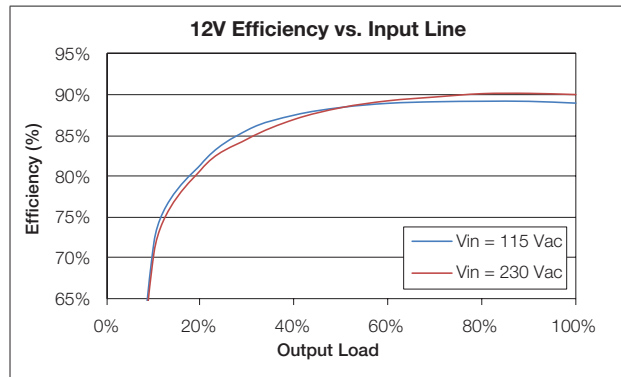

Fig 4. 12 V Efficiency Curve

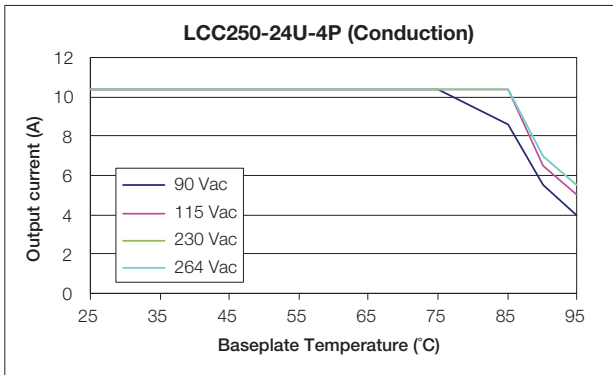

Fig 5. 24 V “4P” Suffix (Conduction) Output Current Derating

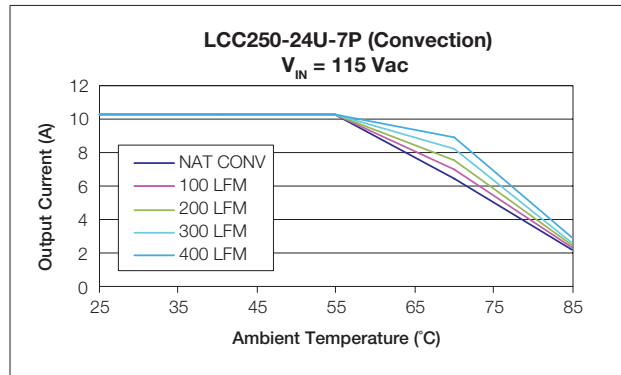

Fig 6. 24 V “7P” Suffix (Convection) Output Current Derating at 115 Vac

ORDERING INFORMATION (CONTINUED)

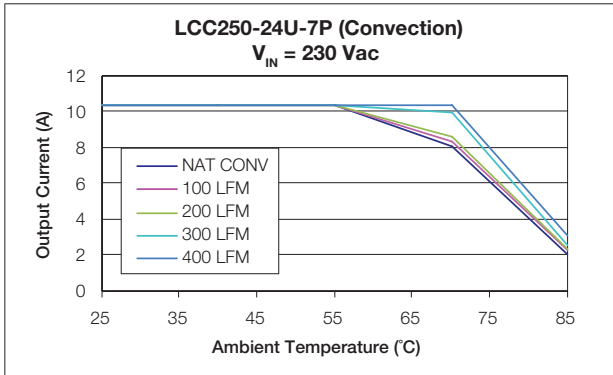

Fig 7. 24 V “7P” Suffix (Convection) Output Current Derating at 230 Vac

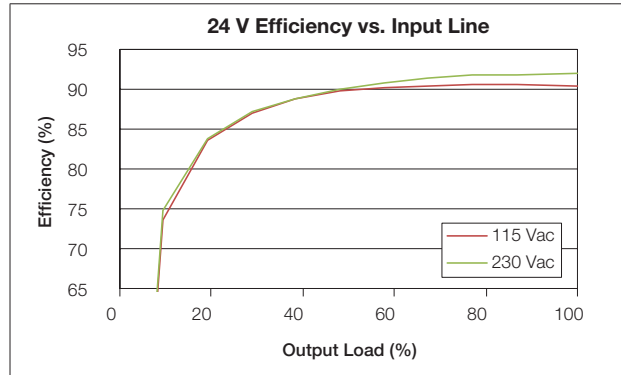

Fig 8. 24 V Efficiency Curve

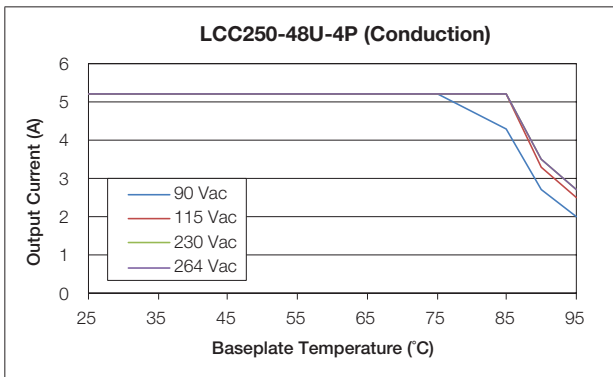

Fig 9. 48 V “4P” Suffix (Conduction) Output Current Derating

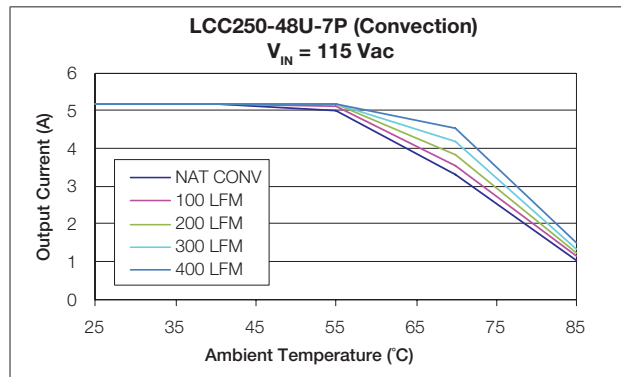

Fig 10. 48 V “7P” Suffix (Convection) Output

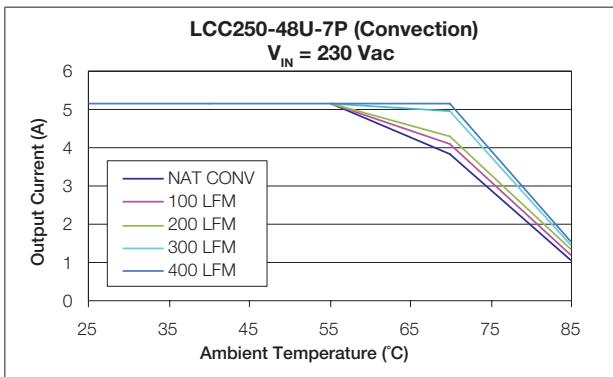

Fig 11. 48 V “7P” Suffix (Convection) Output Current Derating at 230 Vac

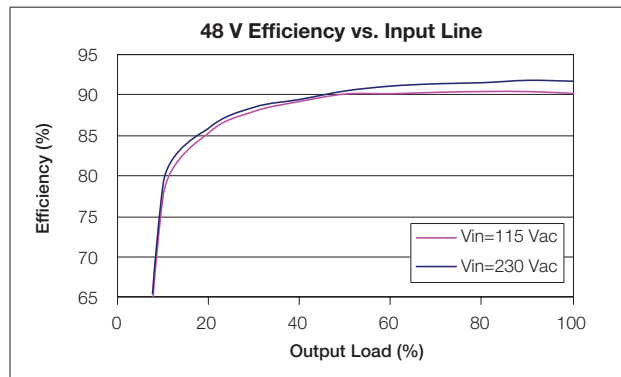
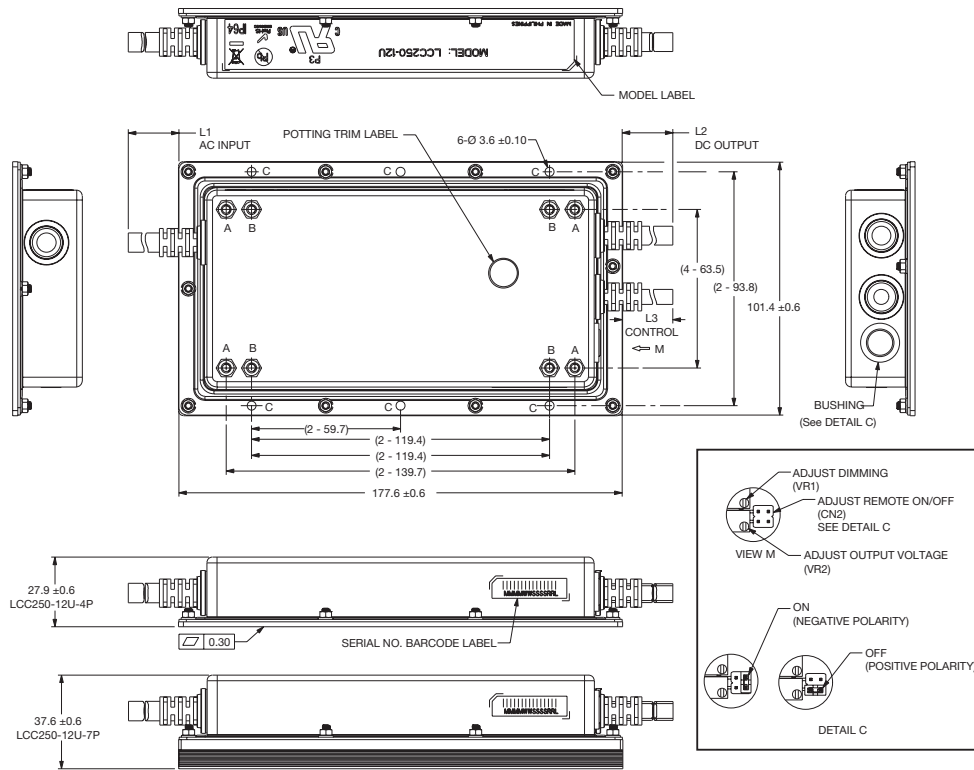

Fig 12. 48 V Efficiency Curve

MECHANICAL DRAWINGS

12V



24V / 48V

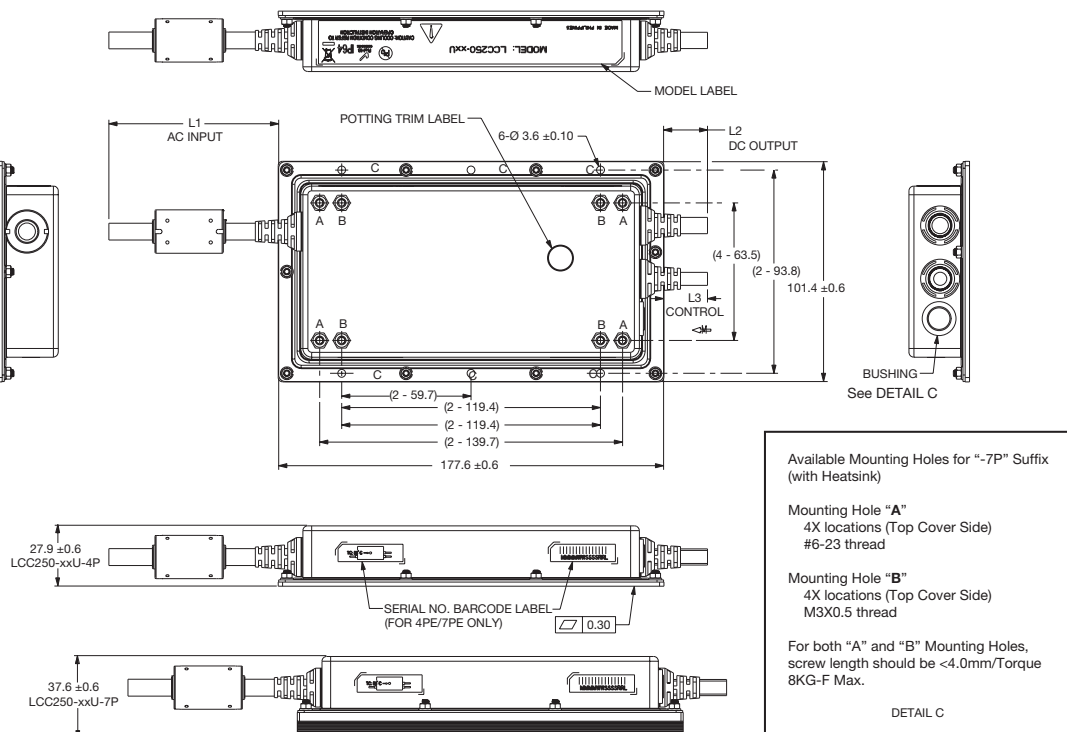

MECHANICAL DRAWINGS (CONTINUED)

Cable	Length	Designation	Wire Color	Wire Gauge
AC Input Cable	L1 = 300 ±10 mm	L = Live	Brown	AWG#18
		N = Neutral	Blue	AWG#18
		PE = Primary Earth	Green/Yellow	AWG#18
DC Output Cable	L2 = 300 ±10 mm	+Output	Blue	AWG#14
		-Output	Gray	AWG#14
Control Cable	L3 = 300 ±10 mm	Dimming	Brown	AWG#26
		Dimming Return	Yellow	AWG#26
		ON/OFF	Orange	AWG#26
		ON/OFF Return	White	AWG#26
		Sense	Red	AWG#26
		Sense Return	Black	AWG#26



For international contact information,
visit advancedenergy.com.

powersales@aei.com (Sales Support)
productsupport.ep@aei.com (Technical Support)
+1 888 412 7832

ABOUT ADVANCED ENERGY

Advanced Energy (AE) has devoted more than three decades to perfecting power for its global customers. AE designs and manufactures highly engineered, precision power conversion, measurement and control solutions for mission-critical applications and processes.

Our products enable customer innovation in complex applications for a wide range of industries including semiconductor equipment, industrial, manufacturing, telecommunications, data center computing, and medical. With deep applications know-how and responsive service and support across the globe, we build collaborative partnerships to meet rapid technological developments, propel growth for our customers, and innovate the future of power.

PRECISION | POWER | PERFORMANCE

Specifications are subject to change without notice. Not responsible for errors or omissions. ©2020 Advanced Energy Industries, Inc. All rights reserved. Advanced Energy®, AE® and Artesyn™ are U.S. trademarks of Advanced Energy Industries, Inc.