

NHD-1.5-128128ASC3

Graphic Color OLED Display Module

NHD-	Newhaven Display
1.5-	1.5" Diagonal Size
128128-	128 x 128 Pixels
AS-	Model
C-	Full Color
3-	+3.3V Power Supply

Newhaven Display International, Inc.

2661 Galvin Ct.

Elgin IL, 60124

Ph: 847-844-8795

Fax: 847-844-8796

www.newhavendisplay.com

nhtech@newhavendisplay.com

nhsales@newhavendisplay.com

Document Revision History

Revision	Date	Description	Changed by
0	11/19/2015	Initial Release	PB
1	1/11/2016	Functions and Features Updated	PB

Functions and Features

- 128 x 128 pixel resolution
- Built-in SSD1351 controller
- SPI MPU interface
- RoHS compliant
- microSD card reader (microSD card not included)
- Breadboard friendly
- Built-in logic level shifting for 3.3V ~ 5V operation

Mechanical Drawing

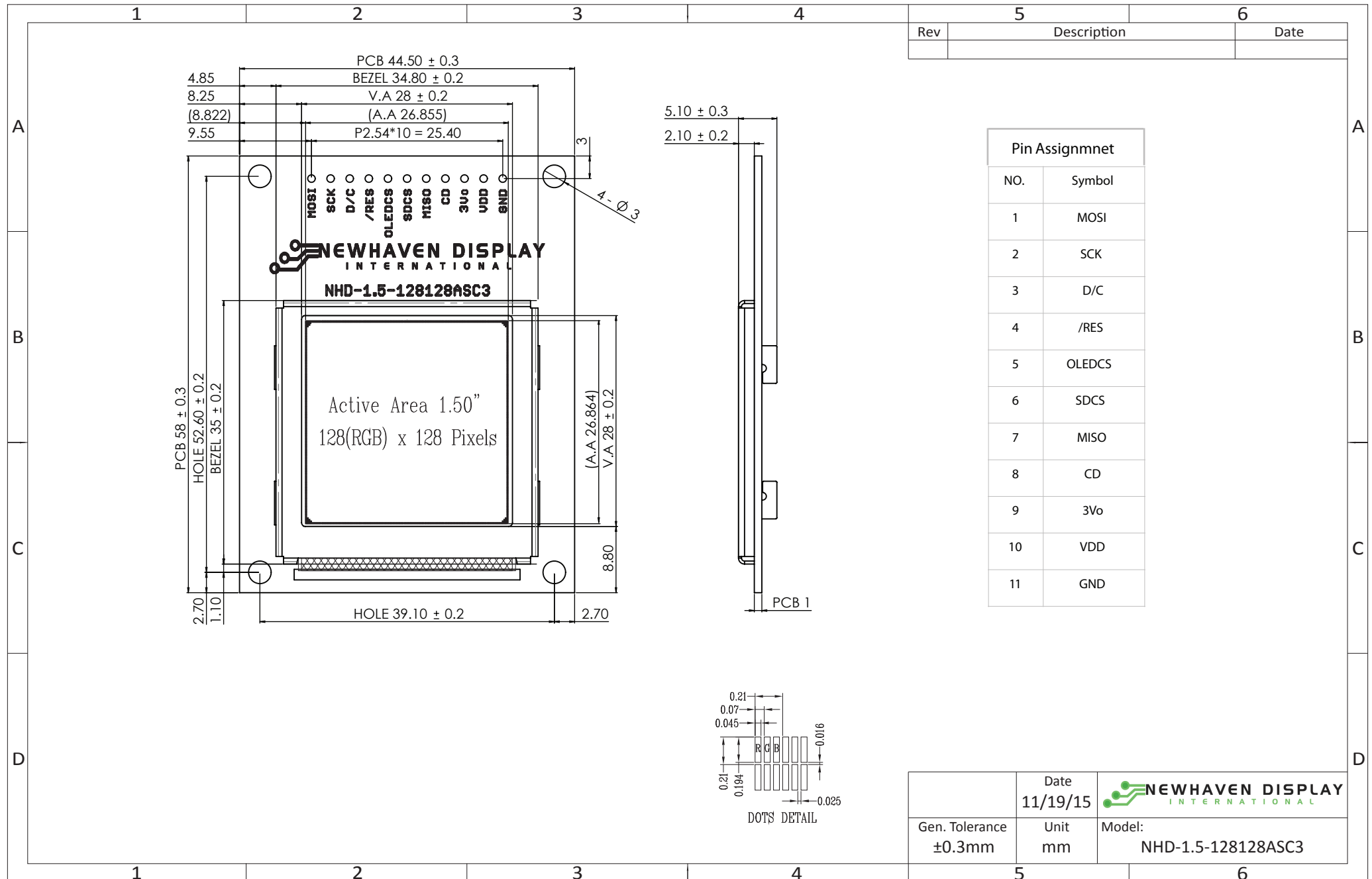

Schematic

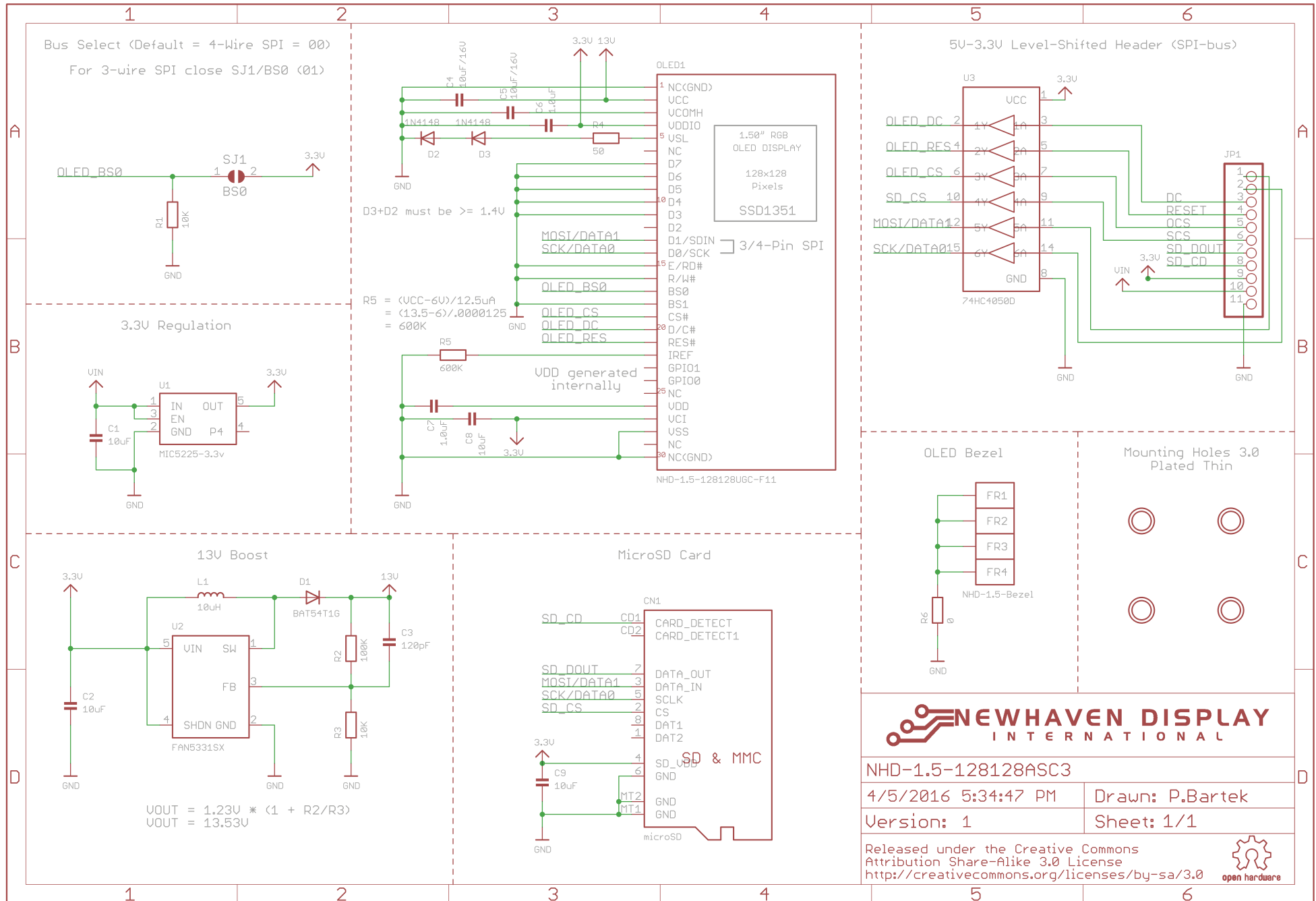

Interface Description

Pin No.	Symbol	External Connection	Function Description
1	MOSI	MPU	Master Out Slave In
2	SCK	MPU	Serial Clock signal
3	D/C	MPU	Register Select signal. D/C=0: Command, D/C=1: Data
4	/RES	MPU	Active LOW Reset signal
5	OLEDCS	MPU	OLED Active LOW Chip Select signal
6	SDCS	MPU	Micro SD Active LOW Chip Select signal
7	MISO	MPU	Master In / Slave Out
8	CD	MPU	Card Detect. Connect a 10K ohm pull-up resistor between this pin and a GPIO on the MPU to detect microSD card. This pin shorts to ground when microSD card is present.
9	3Vo	Power Supply	3.3V Output (No Connect)
10	VDD	Power Supply	Supply Voltage for OLED and logic (3.3V~5V)
11	GND	Power Supply	Ground

Jumper Communication Selection

Solder Jumper Name	4-wire Serial Interface	3-wire Serial Interface
SJ1	Open (default)	Short

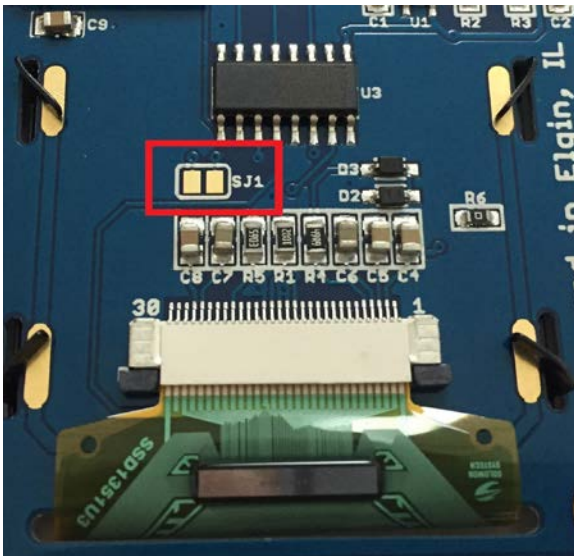

MPU Interface Pin Assignment Summary

Bus Interface	Data/Command Interface			Control Signals				
	MOSI	MISO	SCK	D/C	/RES	OLEDCS	SDCS	CD
4-wire SPI (default)	MOSI	MISO	SCK	D/C	/RES	OLEDCS	SDCS	CD
3-wire SPI	MOSI	MISO	SCK	Tie Low	/RES	OLEDCS	SDCS	CD

Wiring Diagrams

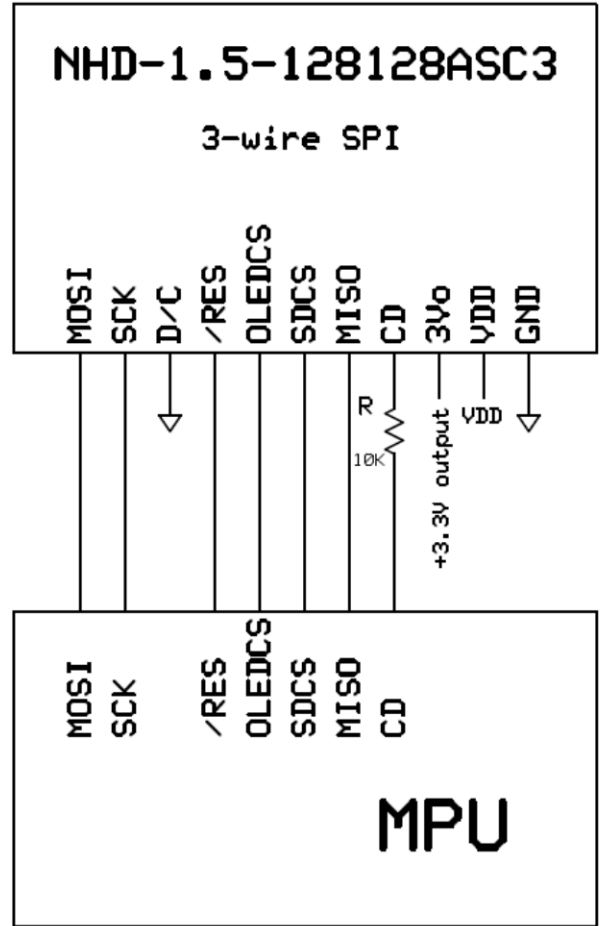
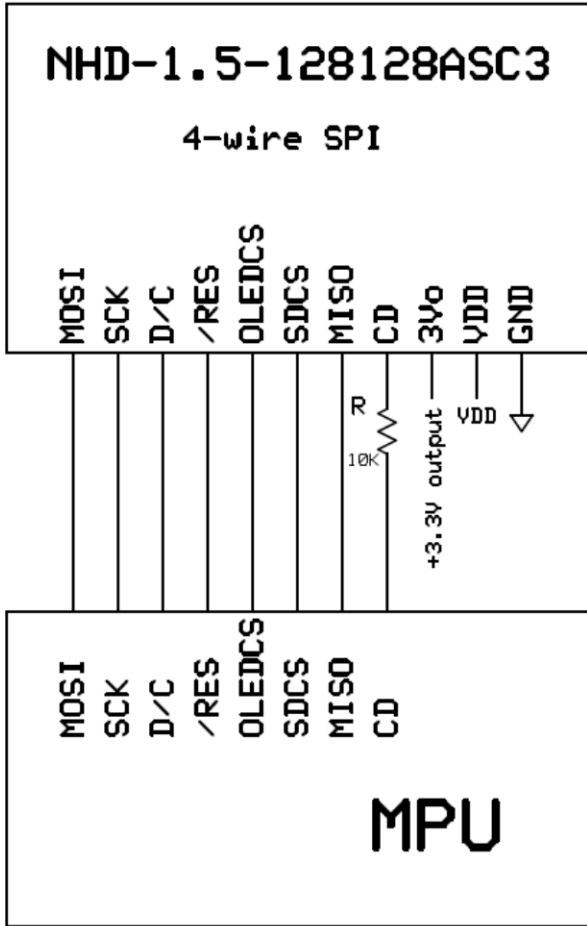

Electrical Characteristics

Item	Symbol	Condition	Min.	Typ.	Max.	Unit
Operating Temperature Range	TOP	Absolute Max	-30	-	+70	°C
Storage Temperature Range	Tst	Absolute Max	-40	-	+80	°C
Supply Voltage	VDD		3.0	3.3	5.5	V
Supply Current	IDD		-	85	200	mA
Sleep Mode Current	IDD _{SLEEP}		-	2	10	μA
"H" Level input	Vih		0.8*VDD	-	VDD	V
"L" Level input	Vil		0	-	0.2*VDD	V
"H" Level output	Voh		0.9*VDD	-	VDD	V
"L" Level output	Vol		0	-	0.1*VDD	V

Optical Characteristics

Item	Symbol	Condition	Min.	Typ.	Max.	Unit
Viewing Angle – Top			80	-	-	°
Viewing Angle – Bottom			80	-	-	°
Viewing Angle – Left			80	-	-	°
Viewing Angle – Right			80	-	-	°
Contrast Ratio	Cr		-	2000:1	-	-
Response Time (rise)	Tr	-	-	10	-	us
Response Time (fall)	Tf	-	-	10	-	us
Brightness		50% checkerboard	70	90	-	cd/m ²
Lifetime		90 cd/m ² , Ta=25°C, 50% checkerboard	10,000	-	-	Hrs

Note: Lifetime at typical temperature is based on accelerated high-temperature operation. Lifetime is tested at average 50% pixels on and is rated as Hours until **Half-Brightness**. The Display OFF command can be used to extend the lifetime of the display.

Luminance of active pixels will degrade faster than inactive pixels. Residual (burn-in) images may occur. To avoid this, every pixel should be illuminated uniformly.

Controller information

Built-in SSD1351 controller.

Please download specification at www.newhavendisplay.com/app_notes/SSD1351.pdf

Table of Commands

(D/C# = 0, R/W#(WR#)= 0, E(RD#) = 1) unless specific setting is stated

Single byte command (D/C# = 0), Multiple byte command (D/C# = 0 for first byte, D/C# = 1 for other bytes)

Fundamental Command Table											
D/C#	Hex	D7	D6	D5	D4	D3	D2	D1	D0	Command	Description
0	15	0	0	0	1	0	1	0	1	Set Column Address	A[6:0]: Start Address. [reset=0] B[6:0]: End Address. [reset=127] Range from 0 to 127
1	A[6:0]	*	A ₆	A ₅	A ₄	A ₃	A ₂	A ₁	A ₀		
1	B[6:0]	*	B ₆	B ₅	B ₄	B ₃	B ₂	B ₁	B ₀		
0	75	0	1	1	1	0	1	0	1	Set Row Address	A[6:0]: Start Address. [reset=0] B[6:0]: End Address. [reset=127] Range from 0 to 127
1	A[6:0]	*	A ₆	A ₅	A ₄	A ₃	A ₂	A ₁	A ₀		
1	B[6:0]	*	B ₆	B ₅	B ₄	B ₃	B ₂	B ₁	B ₀		
0	5C	0	1	0	1	1	1	0	0	Write RAM Command	Enable MCU to write Data into RAM
0	5D	0	1	0	1	1	1	0	1	Read RAM Command	Enable MCU to read Data from RAM
0	A0	1	0	1	0	0	0	0	0	Set Re-map / Color Depth (Display RAM to Panel)	A[0]=0b, Horizontal address increment [reset] A[0]=1b, Vertical address increment
1	A[7:0]	A ₇	A ₆	A ₅	A ₄	A ₃	A ₂	A ₁	A ₀		A[1]=0b, Column address 0 is mapped to SEG0 [reset] A[1]=1b, Column address 127 is mapped to SEG0 A[2]=0b, Color sequence: A → B → C [reset] A[2]=1b, Color sequence is swapped: C → B → A A[3]=0b, Reserved A[3]=1b, Reserved A[4]=0b, Scan from COM0 to COM[N-1] [reset] A[4]=1b, Scan from COM[N-1] to COM0. Where N is the Multiplex ratio. A[5]=0b, Disable COM Split Odd Even A[5]=1b, Enable COM Split Odd Even [reset] A[7:6] Set Color Depth, 00b / 01b: 65k color [reset] 10b: 262k color 11b 262k color, 16-bit format 2 Refer to Table 8-8 for details

Fundamental Command Table											
D/C#	Hex	D7	D6	D5	D4	D3	D2	D1	D0	Command	Description
0 1	A1 A[6:0]	1 *	0 A ₆	1 A ₅	0 A ₄	0 A ₃	0 A ₂	0 A ₁	1 A ₀	Set Display Start Line	Set vertical scroll by RAM from 0~127. [reset=00h]
0 1	A2 A[6:0]	1 *	0 A ₆	1 A ₅	0 A ₄	0 A ₃	0 A ₂	1 A ₁	0 A ₀	Set Display Offset	Set vertical scroll by Row from 0-127. [reset=60h] Note (1) This command is locked by Command FDh by default. To unlock it, please refer to Command FDh.
0	A4~A7	1	0	1	0	0	1	X ₁	X ₀	Set Display Mode	A4h: All OFF A5h: All ON (All pixels have GS63) A6h : Reset to normal display [reset] A7h: Inverse Display (GS0 -> GS63, GS1 -> GS62,)
0 1	AB A[7:0]	1 A ₇	0 A ₆	1 0	0 0	1 0	0 0	1 0	1 A ₀	Function Selection	A[0]=0b, Select external V _{DD} A[0]=1b, Enable internal V _{DD} regulator [reset] A[7:6]=00b, Select 8-bit parallel interface [reset] A[7:6]=01b, Select 16-bit parallel interface A[7:6]=11b, Select 18-bit parallel interface
0	AD	1	0	1	0	1	1	0	1	NOP	Command for no operation.
0	AE~AF	1	0	1	0	1	1	1	X ₀	Set Sleep mode ON/OFF	AEh = Sleep mode On (Display OFF) AFh = Sleep mode OFF (Display ON)
0	B0	1	0	1	1	0	0	0	0	NOP	Command for no operation.
0 1	B1 A[7:0]	1 A ₇	0 A ₆	1 A ₅	1 A ₄	0 A ₃	0 A ₂	0 A ₁	1 A ₀	Set Reset (Phase 1) / Pre-charge (Phase 2) period	A[3:0] Phase 1 period of 5~31 DCLK(s) clocks [reset=0010b] A[3:0]: 0-1 invalid 2 = 5 DCLKs 3 = 7 DCLKs : 15 = 31DCLKs A[7:4] Phase 2 period of 3~15 DCLK(s) clocks [reset=1000b] A[7:4]: 0-2 invalid 3 = 3 DCLKs 4 = 4 DCLKs : 15 = 15DCLKs Note (1) 0 DCLK is invalid in phase 1 & phase 2 (2) This command is locked by Command FDh by default. To unlock it, please refer to Command FDh.

Fundamental Command Table																																					
D/C#	Hex	D7	D6	D5	D4	D3	D2	D1	D0	Command	Description																										
0	B2	1	0	1	1	0	0	1	0	Display Enhancement	A[7:0] = 00h, B[7:0] = 00h, C[7:0] = 00h normal [reset] A[7:0] = A4h, B[7:0] = 00h, C[7:0] = 00h enhance display performance																										
1	A[7:0]	A ₇	A ₆	A ₅	A ₄	A ₃	A ₂	A ₁	A ₀																												
1	B[7:0]	0	0	0	0	0	0	0	0																												
1	C[7:0]	0	0	0	0	0	0	0	0																												
0	B3	1	0	1	1	0	0	1	1	Front Clock Divider (DivSet)/ Oscillator Frequency	A[3:0] [reset=0001], divide by DIVSET where <table border="1"> <thead> <tr> <th>A[3:0]</th> <th>DIVSET</th> </tr> </thead> <tbody> <tr><td>0000</td><td>divide by 1</td></tr> <tr><td>0001</td><td>divide by 2</td></tr> <tr><td>0010</td><td>divide by 4</td></tr> <tr><td>0011</td><td>divide by 8</td></tr> <tr><td>0100</td><td>divide by 16</td></tr> <tr><td>0101</td><td>divide by 32</td></tr> <tr><td>0110</td><td>divide by 64</td></tr> <tr><td>0111</td><td>divide by 128</td></tr> <tr><td>1000</td><td>divide by 256</td></tr> <tr><td>1001</td><td>divide by 512</td></tr> <tr><td>1010</td><td>divide by 1024</td></tr> <tr><td>>=1011</td><td>invalid</td></tr> </tbody> </table> A[7:4] Oscillator frequency, frequency increases as level increases [reset=1101b] Note (1) This command is locked by Command FDh by default. To unlock it, please refer to Command FDh.	A[3:0]	DIVSET	0000	divide by 1	0001	divide by 2	0010	divide by 4	0011	divide by 8	0100	divide by 16	0101	divide by 32	0110	divide by 64	0111	divide by 128	1000	divide by 256	1001	divide by 512	1010	divide by 1024	>=1011	invalid
A[3:0]	DIVSET																																				
0000	divide by 1																																				
0001	divide by 2																																				
0010	divide by 4																																				
0011	divide by 8																																				
0100	divide by 16																																				
0101	divide by 32																																				
0110	divide by 64																																				
0111	divide by 128																																				
1000	divide by 256																																				
1001	divide by 512																																				
1010	divide by 1024																																				
>=1011	invalid																																				
1	A[7:0]	A ₇	A ₆	A ₅	A ₄	A ₃	A ₂	A ₁	A ₀																												
0	B4	1	0	1	1	0	1	0	0	Set Segment Low Voltage (VSL)	A[1:0]=00 External VSL [reset] A[1:0]=01,10,11 are invalid Note (1) When external VSL is enabled, in order to avoid distortion in display pattern, an external circuit is needed to connect between VSL and V _{SS} as shown in Figure 14-1.																										
1	A[7:0]	1	0	1	0	0	0	A ₁	A ₀																												
1	B[7:0]	1	0	1	1	0	1	0	1																												
1	C[7:0]	0	1	0	1	0	1	0	1																												
0	B5	1	0	1	1	0	1	0	1	Set GPIO	A[1:0] GPIO0: 00 pin HiZ, Input disabled 01 pin HiZ, Input enabled 10 pin output LOW [reset] 11 pin output HIGH A[3:2] GPIO1: 00 pin HiZ, Input disabled 01 pin HiZ, Input enabled 10 pin output LOW [reset] 11 pin output HIGH																										
1	A[3:0]	*	*	*	*	A ₃	A ₂	A ₁	A ₀																												
0	B6	1	0	1	1	0	1	0	0	Set Second Pre-charge Period	A[3:0] Set Second Pre-charge Period 0000b invalid 0001b 1 DCLKS 0010b 2 DCLKS 1000 8 DCLKS [reset] 1111 15 DCLKS																										
1	A[3:0]	*	*	*	*	A ₃	A ₂	A ₁	A ₀																												

Fundamental Command Table										Command	Description																		
D/C#	Hex	D7	D6	D5	D4	D3	D2	D2	D0																				
0	B8	1	0	1	1	1	0	0	0	Look Up Table for Gray Scale Pulse width	The next 63 data bytes define Gray Scale (GS) Table by setting the gray scale pulse width in unit of DCLK's (ranges from 0d ~ 180d)																		
1	A1[7:0]	A1 ₇	A1 ₆	A1 ₅	A1 ₄	A1 ₃	A1 ₂	A1 ₁	A1 ₀																				
1	A2[7:0]	A2 ₇	A2 ₆	A2 ₅	A2 ₄	A2 ₃	A2 ₂	A2 ₁	A2 ₀																				
1																				
1																				
1																				
1	A62[7:0]	A62 ₇	A62 ₆	A62 ₅	A62 ₄	A62 ₃	A62 ₂	A62 ₁	A62 ₀																				
1	A63[7:0]	A63 ₇	A63 ₆	A63 ₅	A63 ₄	A63 ₃	A63 ₂	A63 ₁	A63 ₀																				
											Note																		
											⁽¹⁾ 0 ≤ Setting of GS1 < Setting of GS2 < Setting of GS3..... < Setting of GS62 < Setting of GS63																		
											⁽²⁾ GS0 has only pre-charge but no current drive stages.																		
											⁽³⁾ GS1 can be set as only pre-charge but no current drive stage by input gamma setting for GS1 equals 0.																		
0	B9	1	0	1	1	1	0	0	1	Use Built-in Linear LUT [reset= linear]	Reset to default Look Up Table: GS1 = 0 DCLK GS2 = 2 DCLK GS3 = 4 DCLK GS4 = 6 DCLK ... GS62 = 122 DCLK GS63 = 124 DCLK																		
0	BB	1	0	1	1	1	0	1	1	Set Pre-charge voltage	Set pre-charge voltage level.[reset = 17h]																		
1	A[4:0]	0	0	0	A ₄	A ₃	A ₂	A ₁	A ₀																				
											<table border="1"> <thead> <tr> <th>A[4:0]</th> <th>Hex code</th> <th>pre-charge voltage</th> </tr> </thead> <tbody> <tr> <td>00000</td> <td>00h</td> <td>0.20 x V_{CC}</td> </tr> <tr> <td>:</td> <td>:</td> <td>:</td> </tr> <tr> <td>11111</td> <td>1Fh</td> <td>0.60 x V_{CC}</td> </tr> </tbody> </table>	A[4:0]	Hex code	pre-charge voltage	00000	00h	0.20 x V _{CC}	:	:	:	11111	1Fh	0.60 x V _{CC}						
A[4:0]	Hex code	pre-charge voltage																											
00000	00h	0.20 x V _{CC}																											
:	:	:																											
11111	1Fh	0.60 x V _{CC}																											
											Note																		
											⁽¹⁾ This command is locked by Command FDh by default. To unlock it, please refer to Command FDh.																		
0	BE	1	0	1	1	1	1	1	0	Set V _{COMH} Voltage	Set COM deselect voltage level [reset = 05h]																		
1	A[2:0]	0	0	0	0	0	A ₂	A ₁	A ₀																				
											<table border="1"> <thead> <tr> <th>A[2:0]</th> <th>Hex code</th> <th>V_{COMH}</th> </tr> </thead> <tbody> <tr> <td>000</td> <td>00h</td> <td>0.72 x V_{CC}</td> </tr> <tr> <td>:</td> <td>:</td> <td>:</td> </tr> <tr> <td>101</td> <td>05h</td> <td>0.82 x V_{CC} [reset]</td> </tr> <tr> <td>:</td> <td>:</td> <td>:</td> </tr> <tr> <td>111</td> <td>07h</td> <td>0.86 x V_{CC}</td> </tr> </tbody> </table>	A[2:0]	Hex code	V _{COMH}	000	00h	0.72 x V _{CC}	:	:	:	101	05h	0.82 x V _{CC} [reset]	:	:	:	111	07h	0.86 x V _{CC}
A[2:0]	Hex code	V _{COMH}																											
000	00h	0.72 x V _{CC}																											
:	:	:																											
101	05h	0.82 x V _{CC} [reset]																											
:	:	:																											
111	07h	0.86 x V _{CC}																											
											Note																		
											⁽¹⁾ This command is locked by Command FDh by default. To unlock it, please refer to Command FDh.																		

Fundamental Command Table											
D/C#	Hex	D7	D6	D5	D4	D3	D2	D1	D0	Command	Description
0	C1	1	1	0	0	0	0	0	1	Set Contrast Current for Color A,B,C	A[7:0] Contrast Value Color A [reset=10001010b]
1	A[7:0]	A ₇	A ₆	A ₅	A ₄	A ₃	A ₂	A ₁	A ₀		B[7:0] Contrast Value Color B [reset=01010001b]
1	B[7:0]	B ₇	B ₆	B ₅	B ₄	B ₃	B ₂	B ₁	B ₀		C[7:0] Contrast Value Color C [reset=10001010b]
1	C[7:0]	C ₇	C ₆	C ₅	C ₄	C ₃	C ₂	C ₁	C ₀		
0	C7	1	1	0	0	0	1	1	1	Master Contrast Current Control	A[3:0] :
1	A[3:0]	*	*	*	*	A ₃	A ₂	A ₁	A ₀		0000b reduce output currents for all colors to 1/16 0001b reduce output currents for all colors to 2/16 1110b reduce output currents for all colors to 15/16 1111b no change [reset]
0	CA	1	1	0	0	1	0	1	0	Set MUX Ratio	A[6:0] MUX ratio 16MUX ~ 128MUX, [reset=127], (Range from 15 to 127)
1	A[6:0]	0	A ₆	A ₅	A ₄	A ₃	A ₂	A ₁	A ₀		
0	D1	1	0	1	0	1	1	0	1	NOP	Command for No Operation
0	E3	1	1	1	0	0	0	1	1	NOP	Command for No Operation
0	FD	1	1	1	1	1	1	0	1	Set Command Lock	A[7:0]: MCU protection status [reset = 12h] A[7:0] = 12b, Unlock OLED driver IC MCU interface from entering command [reset] A[7:0] = 16b, Lock OLED driver IC MCU interface from entering command
1	A[7:0]	A ₇	A ₆	A ₅	A ₄	A ₃	A ₂	A ₁	A ₀		A[7:0] = B0b, Command A2,B1,B3,BB,BE,C1 inaccessible in both lock and unlock state [reset] A[7:0] = B1b, Command A2,B1,B3,BB,BE,C1 accessible if in unlock state
											Note (1) The locked OLED driver IC MCU interface prohibits all commands and memory access except the FDh command.

Note

(1) "*" stands for "Don't care".

Set (GAC) (D/C# = 0, R/W#(WR#)= 0, E(RD#) = 1) unless specific setting is stated

Single byte command (D/C# = 0), Multiple byte command (D/C# = 0 for first byte, D/C# = 1 for other bytes)

Graphic acceleration command										Command	Description
D/C#	Hex	D7	D6	D5	D4	D3	D2	D2	D0		
0	96	1	0	0	1	0	1	1	0		A[7:0] = 00000000b No scrolling
1	A[7:0]	A ₇	A ₆	A ₅	A ₄	A ₃	A ₂	A ₁	A ₀		A[7:0] = 00000001b to 00111111b Scroll towards SEG127 with 1 column offset
1	B[6:0]	0	B ₆	B ₅	B ₄	B ₃	B ₂	B ₁	B ₀		A[7:0] = 01000000b to 11111111b Scroll towards SEG0 with 1 column offset
1	C[7:0]	C ₇	C ₆	C ₅	C ₄	C ₃	C ₂	C ₁	C ₀		
1	D[6:0]	0	D ₆	D ₅	D ₄	D ₃	D ₂	D ₁	D ₀		B[6:0] : start row address
1	E[1:0]	0	0	0	0	0	0	E ₁	E ₀		C[7:0] : number of rows to be H-scrolled B+C ≤ 128
										Horizontal Scroll	D[6:0] : Reserved (reset=00h)
											E[1:0] : scrolling time interval 00b test mode 01b normal 10b slow 11b slowest
											Note (1) Operates during display ON.
0	9E	1	0	0	1	1	1	1	0	Stop Moving	Stop horizontal scroll
											Note (1) After sending 9Eh command to stop the scrolling action, the ram data needs to be rewritten
0	9F	1	0	0	1	1	1	1	1	Start Moving	Start horizontal scroll

Note

(1) After executed the graphic command, waiting time is required for update GDDRAM content.
V_{CI} = 2.4~3.5V, waiting time = 500ns/pixel.

(2) “*” stands for “Don’t care”.

Timing Characteristics

4-wire SPI:

Symbol	Parameter	Min	Typ	Max	Unit
t_{cycle}	Clock Cycle Time	220	-	-	ns
t_{AS}	Address Setup Time	15	-	-	ns
t_{AH}	Address Hold Time	42	-	-	ns
t_{CSS}	Chip Select Setup Time	20	-	-	ns
t_{CSH}	Chip Select Hold Time	10	-	-	ns
t_{DSW}	Write Data Setup Time	15	-	-	ns
t_{DHW}	Write Data Hold Time	20	-	-	ns
t_{CLKL}	Clock Low Time	20	-	-	ns
t_{CLKH}	Clock High Time	20	-	-	ns
t_{R}	Rise Time	-	-	15	ns
t_{F}	Fall Time	-	-	15	ns

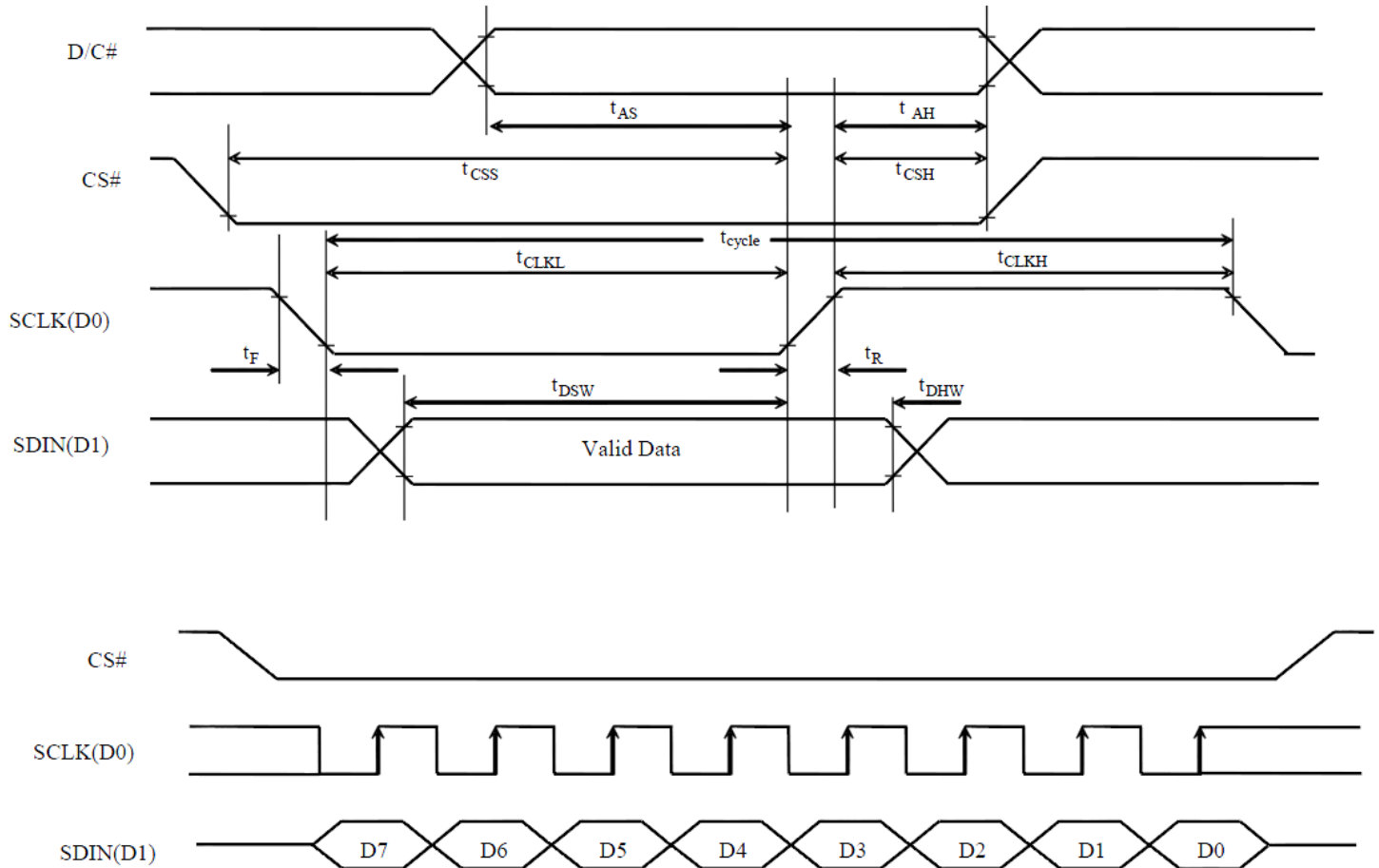

3-wire SPI:

Symbol	Parameter	Min	Typ	Max	Unit
t_{cycle}	Clock Cycle Time	220	-	-	ns
t_{CSS}	Chip Select Setup Time	20	-	-	ns
t_{CSH}	Chip Select Hold Time	44	-	-	ns
t_{DSW}	Write Data Setup Time	15	-	-	ns
t_{DHW}	Write Data Hold Time	20	-	-	ns
t_{CLKL}	Clock Low Time	20	-	-	ns
t_{CLKH}	Clock High Time	20	-	-	ns
t_{R}	Rise Time	-	-	15	ns
t_{F}	Fall Time	-	-	15	ns

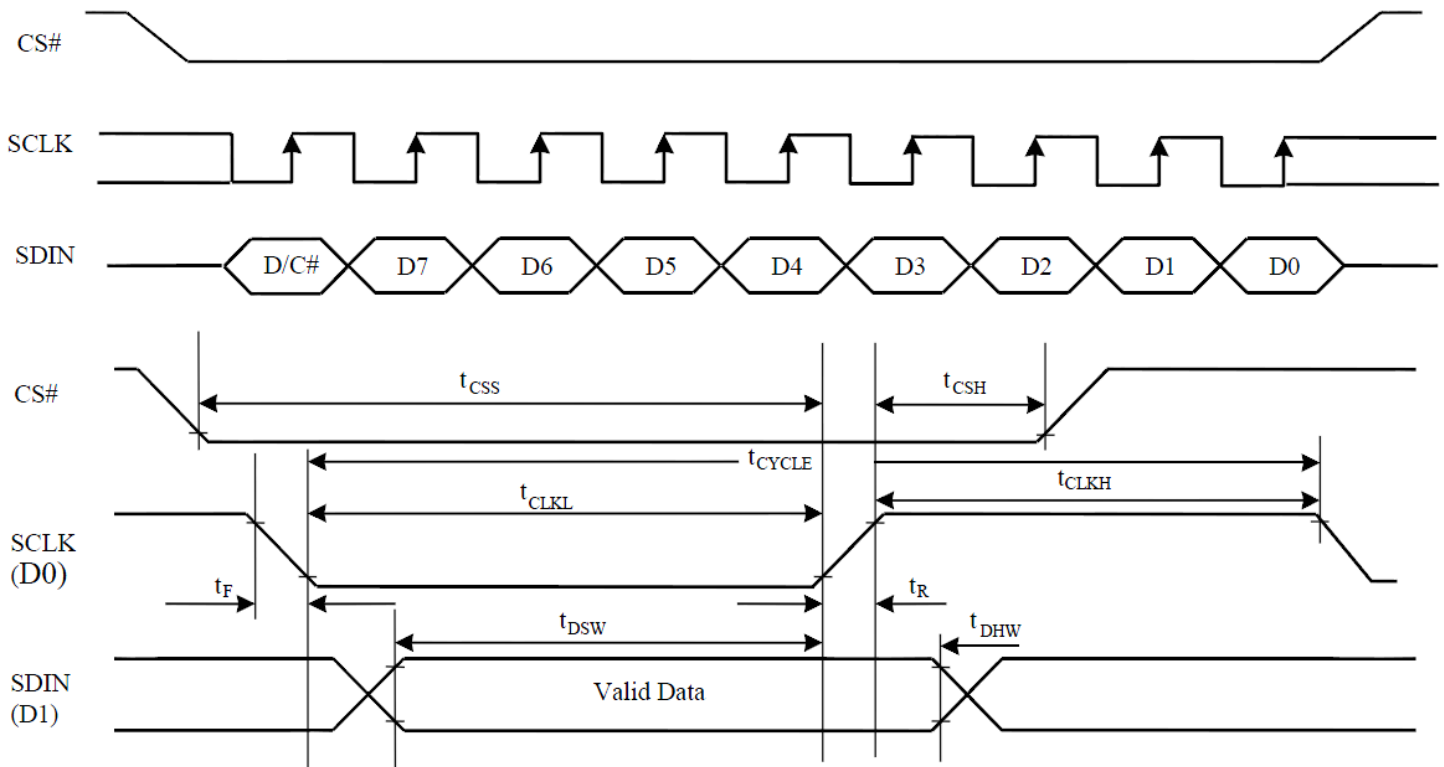

Example Initialization Sequence

```
void OLED_Init_128128RGB(void)
{
int i,j;
GPIO_ResetBits(GPIOC, RES);
graphic_delay(500000);
GPIO_SetBits(GPIOC, RES);
graphic_delay(500000);

oled_Command_128128RGB(0xFD); //Command lock setting
oled_Data_128128RGB(0x12); //unlock
oled_Command_128128RGB(0xFD); //Command lock setting
oled_Data_128128RGB(0xB1); //unlock

oled_Command_128128RGB(0xAE);

oled_Command_128128RGB(0xB3); //clock & frequency
oled_Data_128128RGB(0xF1); //clock=Diviser+1 frequency=fh

oled_Command_128128RGB(0xCA); //Duty
oled_Data_128128RGB(0x7F); //OLED_END+1

oled_Command_128128RGB(0xA2); //Display offset
oled_Data_128128RGB(0x00);

oled_Command_128128RGB(0xA1); //Set display start line
oled_Data_128128RGB(0x00); //0x00 start line

oled_Command_128128RGB(0xA0); //Set Re-map, color depth
oled_Data_128128RGB(0xA0); //8-bit 262K

oled_Command_128128RGB(0xB5); //set GPIO
oled_Data_128128RGB(0x00); //disabled

oled_Command_128128RGB(0xAB); //Function Set
oled_Data_128128RGB(0x01); //8-bit interface, internal VDD regulator

oled_Command_128128RGB(0xB4); //set VSL
oled_Data_128128RGB(0xA0); //external VSL
oled_Data_128128RGB(0xB5);
oled_Data_128128RGB(0x55);

oled_Command_128128RGB(0xC1); //Set contrast current for A,B,C
oled_Data_128128RGB(0x8a); //Color A //8a
oled_Data_128128RGB(0x51); //Color B //51
oled_Data_128128RGB(0x8a); //Color C //8a

oled_Command_128128RGB(0xC7); //Set master contrast
oled_Data_128128RGB(0x0F); //
```



```

oled_Command_128128RGB(0xB9); //use linear grayscale LUT

oled_Command_128128RGB(0xB1); //Set pre & dis-charge
oled_Data_128128RGB(0x32); //pre=1h, dis=1h

oled_Command_128128RGB(0xBB); //Set precharge voltage of color A,B,C
oled_Data_128128RGB(0x07); //

oled_Command_128128RGB(0xB2); //display enhancement
oled_Data_128128RGB(0xa4);
oled_Data_128128RGB(0x00);
oled_Data_128128RGB(0x00);

oled_Command_128128RGB(0xB6); //precharge period
oled_Data_128128RGB(0x01);

oled_Command_128128RGB(0xBE); //Set VcomH
oled_Data_128128RGB(0x07);

oled_Command_128128RGB(0xA6); //Normal display

oled_Command_128128RGB(0x15); //set column start and end addresses
oled_Data_128128RGB(0x00); //
oled_Data_128128RGB(0x7F); //
oled_Command_128128RGB(0x75); //set row start and end addresses
oled_Data_128128RGB(0x00); //
oled_Data_128128RGB(0x7F); //
oled_Command_128128RGB(0x5C); //write to RAM command

    for(i=0;i<128;i++)
    {
        for(j=0;j<128;j++)
        {
            oled_Data_128128RGB(0x00);
            oled_Data_128128RGB(0x00);
            oled_Data_128128RGB(0x00);
        }
    }
oled_Command_128128RGB(0xAF); //Display on
}

int oled_128128RGB(void)
{
column = 0x00;
byte1 = 0x00;
byte2 = 0x00;
oled_Command_128128RGB(0x15); //set column start and end addresses
oled_Data_128128RGB(column); //
oled_Data_128128RGB(0x7F); //

```

```

oled_Command_128128RGB(0x75);    //set row start and end addresses
oled_Data_128128RGB(0x00);      //
oled_Data_128128RGB(0x7F);      //
oled_Command_128128RGB(0x5C);    //write to RAM command

for (i=0;i<16384;i++)    //for each 24-bit pixel...128*128=16384
{
    f_read(&File1, &red, 1, &blen);    //read the red 8-bits
    f_read(&File1, &green, 1, &blen);    //read the green 8-bits
    f_read(&File1, &blue, 1, &blen);    //read the blue 8-bits

    red = red >> 2;
    green = green >> 2;
    blue = blue >> 2;
    oled_Data_128128RGB(red);
    oled_Data_128128RGB(green);
    oled_Data_128128RGB(blue);

}
////////////////////////////////////

```

Example Arduino Code

Please see: https://github.com/NewhavenDisplay/NHD-1.5-128128ASC3_Example

Quality Information

Test Item	Content of Test	Test Condition	Note
High Temperature storage	Test the endurance of the display at high storage temperature.	+80°C , 96hrs	2
Low Temperature storage	Test the endurance of the display at low storage temperature.	-40°C , 96hrs	1,2
High Temperature Operation	Test the endurance of the display by applying electric stress (voltage & current) at high temperature.	+70°C 96hrs	2
Low Temperature Operation	Test the endurance of the display by applying electric stress (voltage & current) at low temperature.	-30°C , 96hrs	1,2
High Temperature / Humidity Operation	Test the endurance of the display by applying electric stress (voltage & current) at high temperature with high humidity.	+60°C , 90% RH , 96hrs	1,2
Thermal Shock resistance	Test the endurance of the display by applying electric stress (voltage & current) during a cycle of low and high temperatures.	-30°C,30min -> 25°C,5min -> 70°C,30min = 1 cycle 100 cycles	
Vibration test	Test the endurance of the display by applying vibration to simulate transportation and use.	10-22Hz , 15mm amplitude. 22-500Hz, 1.5G 30min in each of 3 directions X,Y,Z	3
Atmospheric Pressure test	Test the endurance of the display by applying atmospheric pressure to simulate transportation by air.	115mbar, 40hrs	3
Static electricity test	Test the endurance of the display by applying electric static discharge.	VS=800V, RS=1.5kΩ, CS=100pF One time	

Note 1: No condensation to be observed.

Note 2: Conducted after 2 hours of storage at 25°C, 0%RH.

Note 3: Test performed on product itself, not inside a container.

Evaluation Criteria:

- 1: Display is fully functional during operational tests and after all tests, at room temperature.
- 2: No observable defects.
- 3: Luminance >50% of initial value.
- 4: Current consumption within 50% of initial value

Precautions for using OLEDs/LCDs/LCMs

See Precautions at www.newhavendisplay.com/specs/precautions.pdf

Warranty Information and Terms & Conditions

http://www.newhavendisplay.com/index.php?main_page=terms