



The Future of Analog IC Technology®

MP6534

5V to 55V, Three-Phase, Brushless DC Motor Pre-Driver with Buck Regulator

DESCRIPTION

The MP6534 is a gate driver IC designed for three-phase brushless DC motor driver applications. It is capable of driving three half bridges consisting of 6 N-channel power MOSFETs up to 55V. The MP6534 includes a 500mA buck regulator to generate local power for microcontrollers or other circuitry.

The MP6534 integrates a regulated charge pump to generate gate drive power, and uses a bootstrap capacitor to generate a supply voltage for the high-side MOSFET driver. An internal trickle-charge circuit maintains sufficient high-side gate driver voltage even when an output is operated at 100% duty cycle.

Internal protection features include programmable short-circuit protection, over-current protection, adjustable dead-time control, undervoltage lockout, and thermal shutdown.

The MP6534 is available in a 40-contact QFN (5mm x 5mm) package with an exposed thermal pad.

FEATURES

- Wide 5V to 55V Input Voltage Range
- Charge Pump Gate Drive Supply
- Bootstrap High-Side Driver with Trickle-Charge Circuit Supports 100% Duty Cycle Operation
- 500mA Buck Regulator
- Low-Power Sleep Mode
- Programmable Short-Circuit Protection
- Over-Current Protection
- Adjustable Dead-Time Control to Prevent Shoot-Through
- Thermal Shutdown and UVLO Protection
- Fault Indication Output
- Thermally Enhanced Surface-Mount Package

APPLICATIONS

- 3-Phase, Brushless DC Motors and Permanent Magnet Synchronous Motors
- Power Drills
- E-Bikes

All MPS parts are lead-free, halogen-free, and adhere to the RoHS directive. For MPS green status, please visit the MPS website under Quality Assurance. "MPS" and "The Future of Analog IC Technology" are registered trademarks of Monolithic Power Systems, Inc.

TYPICAL APPLICATION

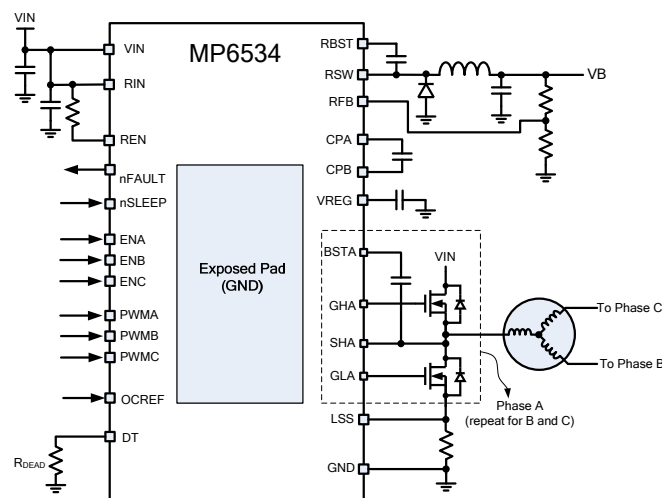

ORDERING INFORMATION

| Part Number* | Package | Top Marking |
|--------------|------------------|-------------|
| MP6534GU | QFN-40 (5mmx5mm) | See Below |

* For Tape & Reel, add suffix -Z (e.g. MP6535GU-Z)

TOP MARKING

MPSYYWW
MP6534
LLLLLLL

MPS: MPS prefix
 YY: Year code
 WW: Week code
 MP6534: Part number
 LLLLLLL: Lot number

PACKAGE REFERENCE

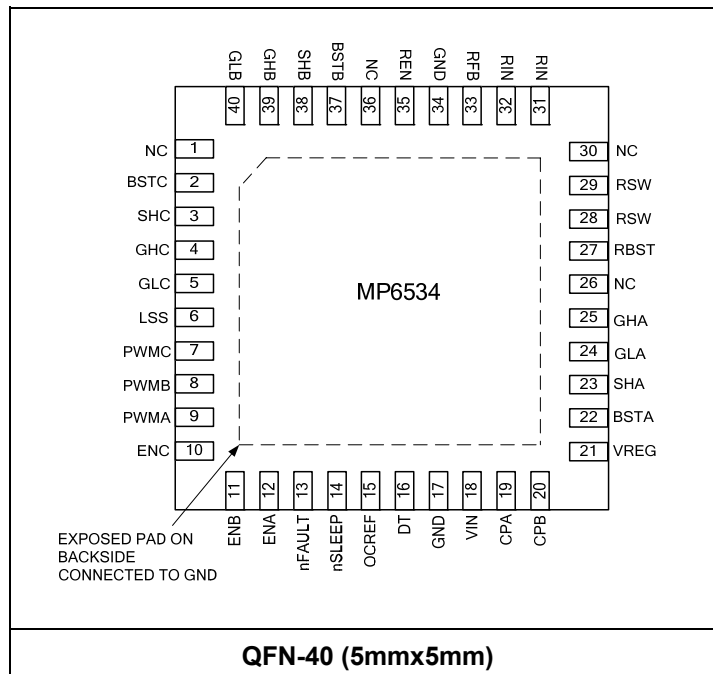

ABSOLUTE MAXIMUM RATINGS (1)

| | |
|--|-----------------------------------|
| Input voltage (V_{IN}) | -0.3V to 65V |
| Input voltage (V_{RIN}) | -0.3V to 60V |
| RSW | -0.3V to $V_{RIN} + 0.3V$ |
| RBST | $V_{RSW} + 6V$ |
| CPA | -0.3V to 60V |
| CPB | -0.3V to 12.5V |
| VREG | -0.3V to 13V |
| BSTA/B/C | -0.3V to 70V |
| GHA/B/C | -0.3V to 70V |
| GHA/B/C (Transient, 2 μ S) | -8V to 70V |
| SHA/B/C | -0.3V to 60V |
| SHA/B/C (Transient, 2 μ S) | -8V to 65V |
| GLA/B/C | -0.3V to 13V |
| ESD rating (HBD) | 2kV |
| All other pins to AGND | -0.3V to 6.5V |
| Continuous power dissipation ($T_A = +25^\circ C$) (2) | |
| QFN-40 (5mmx5mm) | 3.47W |
| Storage temperature | -55 $^\circ C$ to +150 $^\circ C$ |
| Junction temperature | +150 $^\circ C$ |
| Lead temperature (solder) | +260 $^\circ C$ |
| ESD (Human Body Model) | 1500V |

Recommended Operating Conditions (3)

| | |
|--|-----------------------------------|
| Input voltage (V_{IN} , V_{RIN}) | +5V to 55V |
| OCREF voltage (V_{OC}) | +0.125V to 2.4V |
| Operating junction temp. (T_J) | -40 $^\circ C$ to +125 $^\circ C$ |

| | | |
|-------------------------------|--------------------|---------------|
| Thermal Resistance (4) | θ_{JA} | θ_{JC} |
| QFN-40 (5mmx5mm) | 36 | 8 |
| | $^\circ C/W$ | |

NOTES:

- 1) Exceeding these ratings may damage the device.
- 2) The maximum allowable power dissipation is a function of the maximum junction temperature T_J (MAX), the junction-to-ambient thermal resistance θ_{JA} , and the ambient temperature T_A . The maximum allowable continuous power dissipation at any ambient temperature is calculated by P_D (MAX) = $(T_J$ (MAX) - T_A) / θ_{JA} . Exceeding the maximum allowable power dissipation produces an excessive die temperature, causing the regulator to go into thermal shutdown. Internal thermal shutdown circuitry protects the device from permanent damage.
- 3) The device is not guaranteed to function outside of its operating conditions.
- 4) Measured on JESD51-7, 4-layer PCB.

ELECTRICAL CHARACTERISTICS (MOTOR PRE-DRIVER)
 $V_{IN} = 24V$, $T_A = 25^{\circ}C$, unless otherwise noted.

| Parameter | Symbol | Condition | Min | Typ | Max | Units |
|---|-----------------|-----------------------------------|------|------|------|-------------|
| Power Supply | | | | | | |
| Input supply voltage | V_{IN} | | 5 | | 55 | V |
| Quiescent current | I_Q | nSLEEP = 1, gate not switching | | 0.95 | 2 | mA |
| | I_{SLEEP} | nSLEEP = 0 | | | 1 | μA |
| Control Logic | | | | | | |
| Input logic low threshold | V_{IL} | | | | 0.8 | V |
| Input logic high threshold | V_{IH} | | 2 | | | V |
| Logic input current | $I_{IN(H)}$ | $V_{IH} = 5V$ | -20 | | 20 | μA |
| | $I_{IN(L)}$ | $V_{IL} = 0.8V$ | -20 | | 20 | μA |
| nSLEEP pull-down current | $I_{SLEEP-PD}$ | | | 1 | | μA |
| Internal pull-down resistance | R_{PD} | All logic inputs except nSLEEP | | 880 | | k Ω |
| Fault Outputs (Open-Drain Outputs) | | | | | | |
| Output low voltage | V_{OL} | $I_O = 5mA$ | | | 0.5 | V |
| Output high leakage current | I_{OH} | $V_O = 3.3V$ | | | 1 | μA |
| Protection Circuit | | | | | | |
| UVLO rising threshold | V_{IN_RISE} | | 3.3 | 3.9 | 4.5 | V |
| UVLO hysteresis | V_{IN_HYS} | | | 200 | | mV |
| VREG rising threshold | V_{REG_RISE} | | 6.8 | 7.6 | 8.4 | V |
| VREG hysteresis | V_{REG_HYS} | | | 0.54 | 1 | V |
| VREG start-up delay | t_{REG} | | | 800 | | μs |
| Short-Circuit Threshold Accuracy (MOSFET V_{DS}) | V_{SC} | $V_{OC} = 1V$ | 0.8 | 1 | 1.2 | V |
| | | $V_{OC} = 2.4V$ | 2.18 | 2.4 | 2.62 | V |
| OCF deglitch time | t_{OC} | | | 3 | | μs |
| SLEEP wake-up time | t_{SLEEP} | | | 1 | | ms |
| LSS OCP threshold | $V_{LSS-OCF}$ | | 0.4 | 0.5 | 0.6 | V |
| Thermal shutdown | T_{TSD} | | | 150 | | $^{\circ}C$ |

ELECTRICAL CHARACTERISTICS (MOTOR PRE-DRIVER) (continued)
 $V_{IN} = 24V$, $T_A = 25^{\circ}C$, unless otherwise noted.

| Parameter | Symbol | Condition | Min | Typ | Max | Units |
|------------------------------------|-----------------|-----------------------|-----------------------|------|------|------------|
| Gate Drive | | | | | | |
| Bootstrap diode forward voltage | V_{FBOOT} | $I_D = 10mA$ | | | 0.9 | V |
| | | $I_D = 100mA$ | | | 1.3 | V |
| VREG output voltage | V_{REG} | $V_{IN} = 5.5V - 55V$ | 10 | 11.5 | 12.8 | |
| | | $V_{IN} = 5V$ | $2 \times V_{IN} - 1$ | | | V |
| Maximum source current | $I_{OSO}^{(5)}$ | | | 0.8 | | A |
| Maximum sink current | $I_{OSI}^{(5)}$ | | | 1 | | A |
| Gate drive pull-up resistance | R_{UP} | $V_{DS} = 1V$ | | 8 | | Ω |
| HS gate drive pull-down resistance | R_{HS-DN} | $V_{DS} = 1V$ | 1.2 | | 4.7 | Ω |
| LS gate drive pull-down resistance | R_{LS-DN} | $V_{DS} = 1V$ | 1 | | 5 | Ω |
| LS passive pull-down resistance | R_{LS-PDN} | | | 590 | | k Ω |
| LS automatic turn-on time | t_{LS} | At ENx rising edge | | 1.8 | | μs |
| Charge pump frequency | f_{CP} | | | 110 | | kHz |
| Dead time | t_{DEAD} | Leave DT open | | 6 | | μs |
| | | $R_{DT} = 200k\Omega$ | | 0.74 | | μs |
| | | DT tied to GND | | 30 | | ns |

NOTE:

5) Guaranteed by design – not tested in production

ELECTRICAL CHARACTERISTICS (BUCK REGULATOR)

$V_{IN} = 12V$, $T_A = 25^{\circ}C$, unless otherwise noted.

| Parameters | Symbol | Condition | Min | Typ | Max | Units |
|--|-----------------|------------------------------------|-------|-------|-------|-------------|
| Feedback voltage | V_{FB} | | 0.792 | 0.812 | 0.832 | V |
| Feedback current | I_{FB} | $V_{RFB} = 0.85V$ | | | 0.1 | μA |
| Switch-on resistance | $R_{DS(ON)}$ | | | 1 | | Ω |
| Switch leakage | I_{SW_LKG} | $V_{REN} = 0V$, $V_{RSW} = 0V$ | | | 1 | μA |
| Current limit | I_{LIM} | | 1.0 | 1.25 | 1.5 | A |
| Oscillator frequency | f_{SW} | $V_{FB} = 0.6V$ | 330 | 450 | 570 | kHz |
| Foldback frequency | f_{SW_F} | $V_{RFB} = 0V$ | | 135 | | kHz |
| Maximum duty cycle | D_{MAX} | $V_{RFB} = 0.6V$ | 90 | 93.5 | | % |
| Minimum on time | T_{ON} | | | 100 | | ns |
| Under-voltage lockout threshold rising | V_{UVLO_R} | | 2.9 | 3.3 | 3.7 | V |
| Under-voltage lockout threshold falling | V_{UVLO_F} | | 2.55 | 3.05 | 3.45 | V |
| Under-voltage lockout threshold hysteresis | V_{UVLO_HYS} | | | 320 | | mV |
| REN threshold rising | V_{EN_R} | | | 1.35 | | V |
| REN threshold falling | V_{EN_F} | | | 1.17 | | V |
| REN threshold hysteresis | V_{EN_HYS} | | | 180 | | mV |
| REN input current | I_{EN} | $V_{REN} = 2V$ | | 3.1 | | μA |
| | | $V_{REN} = 0V$ | | 0.1 | | |
| Supply current (shutdown) | I_S | $V_{REN} = 0V$ | | 0.1 | 1.0 | μA |
| Supply current (quiescent) | I_Q | $V_{REN} = 2V$, $V_{FB} = 1V$ | | 0.73 | 0.85 | mA |
| Thermal shutdown | T_{SD} | | | 165 | | $^{\circ}C$ |
| Thermal shutdown hysteresis | T_{SD_HYS} | | | 20 | | $^{\circ}C$ |

TYPICAL CHARACTERISTICS

Motor Pre-Driver

UVLO Rising Threshold vs. Temperature

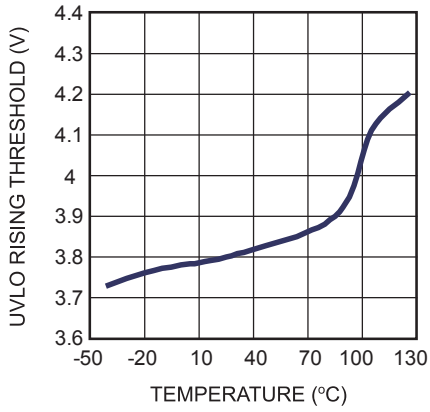

VREG Rising Threshold vs. Temperature

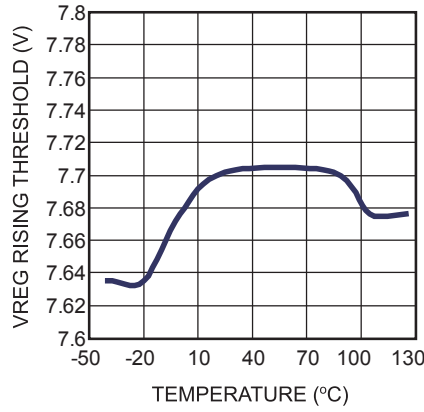

OC_REF Threshold vs. Temperature

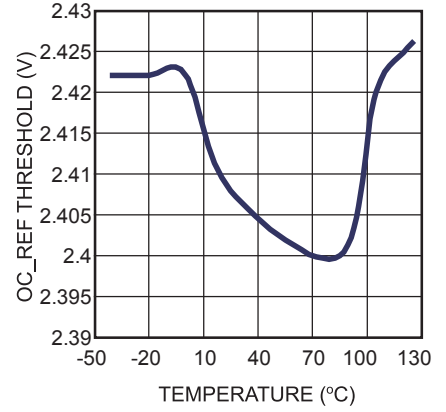

LSS Current Limit Threshold vs. Temperature

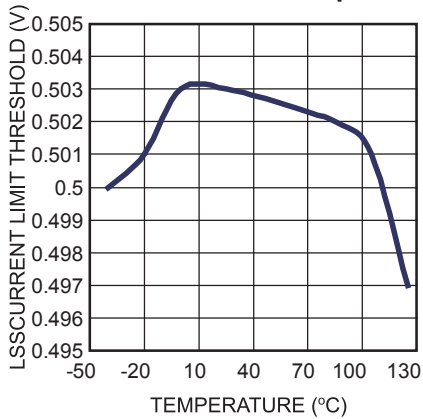

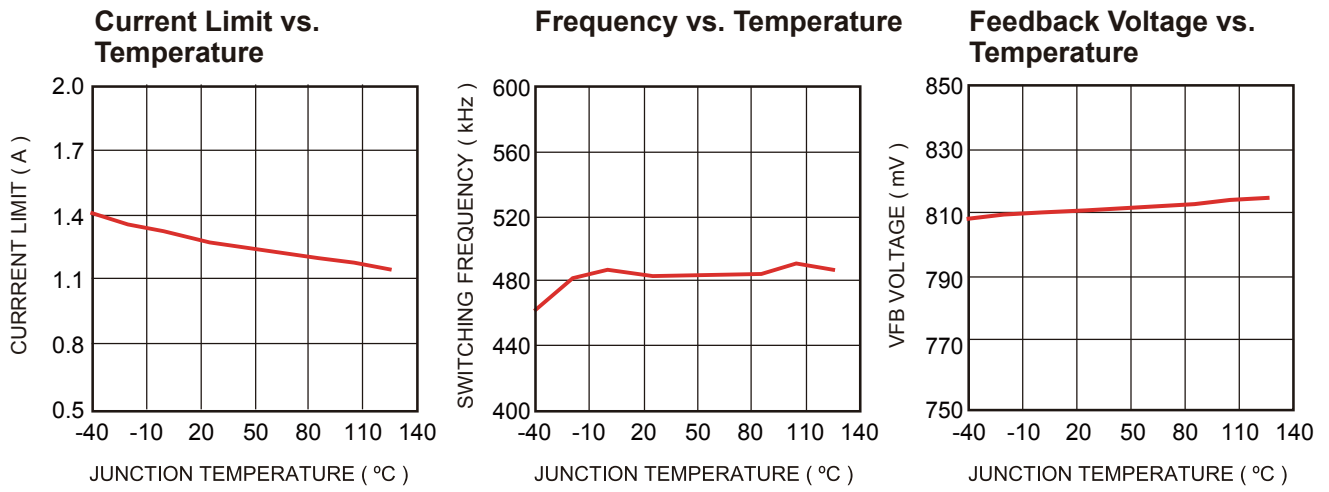
TYPICAL CHARACTERISTICS (continued)
Buck Regulator

TYPICAL PERFORMANCE CHARACTERISTICS

Motor Pre-Driver

$V_{IN} = 24V$, $OC_REF = 0.5V$, $R_{DT} = 200k$, $ENA = ENC = H$, $F_{PWM} = 20kHz$, $T_A = 25^\circ C$,

Resistor + Inductor Load: $5\Omega + 1mH$ /phase with star connection, unless otherwise noted.

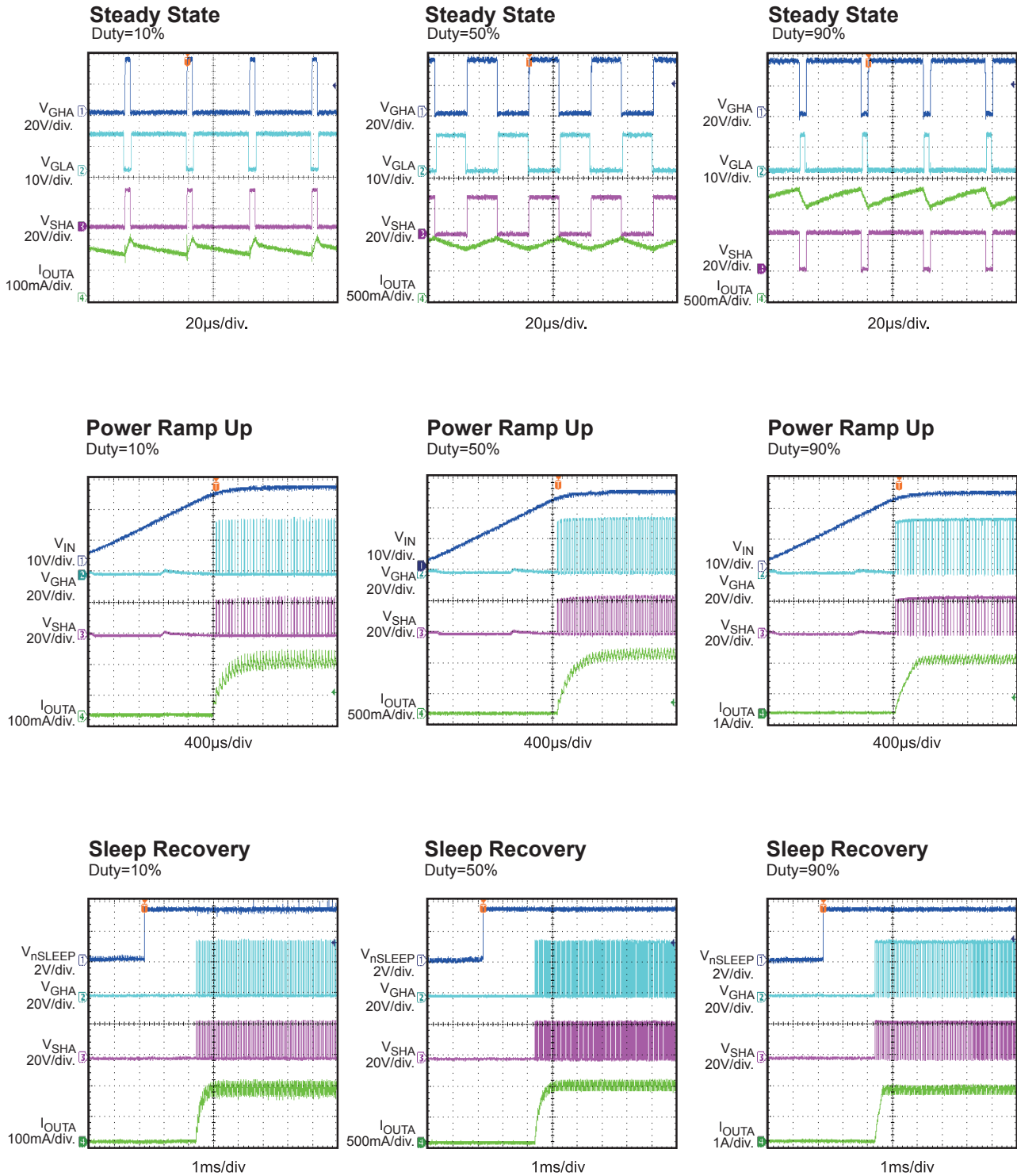

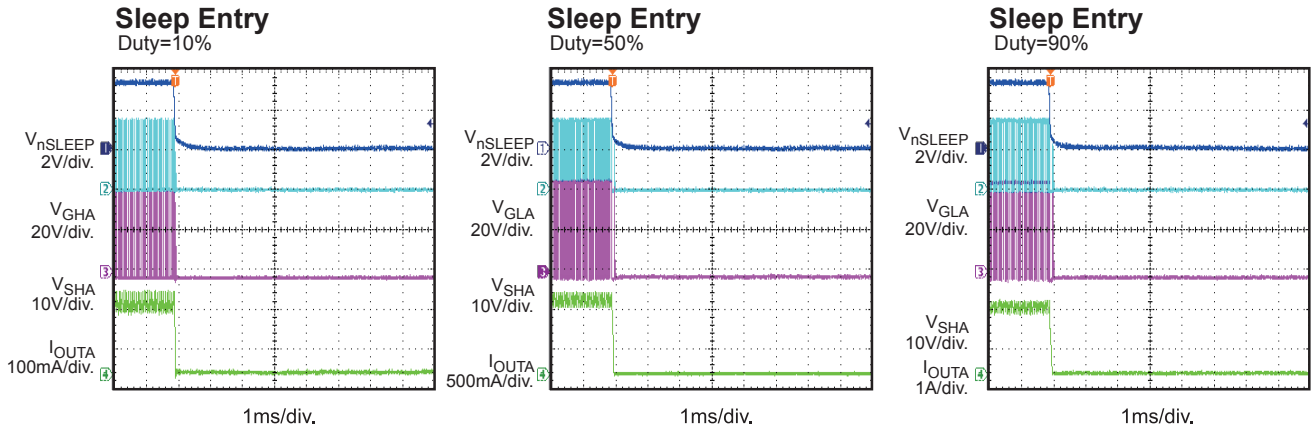
TYPICAL PERFORMANCE CHARACTERISTICS (continued)
Motor Pre-Driver
 $V_{IN} = 24V$, $OC_REF = 0.5V$, $R_{DT} = 200k$, $ENA = ENC = H$, $F_{PWMA} = 20kHz$, $T_A = 25^\circ C$,
Resistor + Inductor Load: $5\Omega + 1mH$ /phase with star connection, unless otherwise noted.

TYPICAL PERFORMANCE CHARACTERISTICS

Buck Regulator

$V_{IN} = 12V$, $V_{OUT} = 5V$, $L = 22\mu H$, $T_A = 25^\circ C$, unless otherwise noted.

Steady State

$V_{IN}=8V$, $I_{OUT}=0.8A$

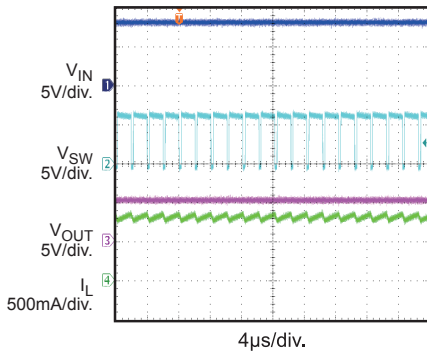

Steady State

$I_{OUT}=0.15A$

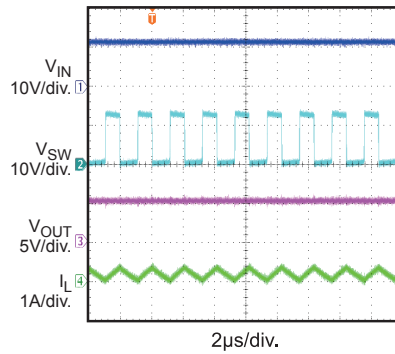

Load Transient

$I_{OUT}=0.2A$ to $0.7A$

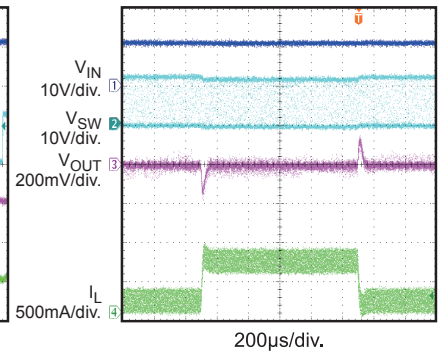

Steady State

$V_{IN}=6V$, $V_{OUT}=3.3V$, $I_{OUT}=0.1A$

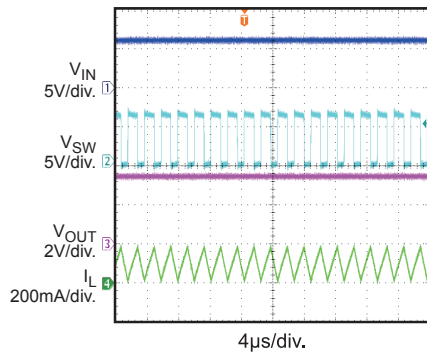

Steady State

$V_{IN}=60V$, $V_{OUT}=3.3V$, $I_{OUT}=0.9A$

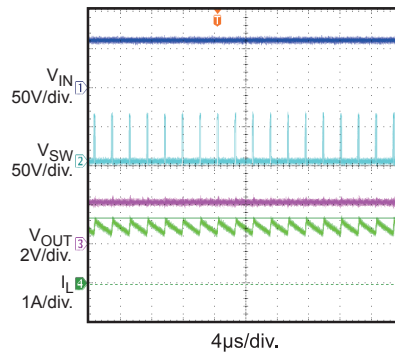

Load Transient

$V_{OUT}=3.3V$, $I_{OUT}=0.2A$ to $0.7A$

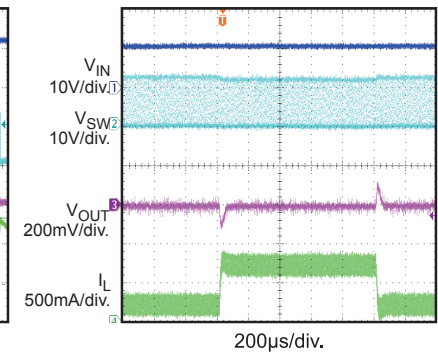

Power Ramp Up

$V_{IN}=60V$, $I_{OUT}=0.5A$

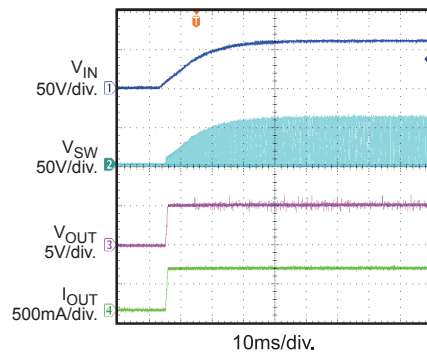

Power Ramp Down

$V_{IN}=60V$, $I_{OUT}=0.5A$

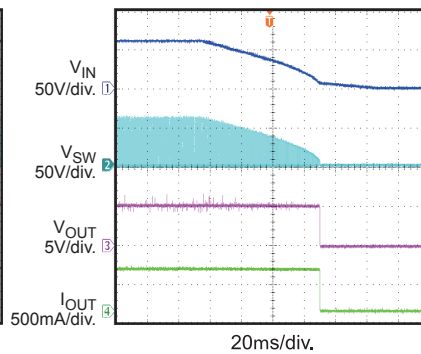

Short Output

$I_{OUT}=0.65A$

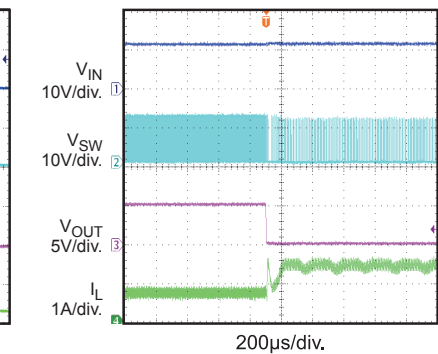

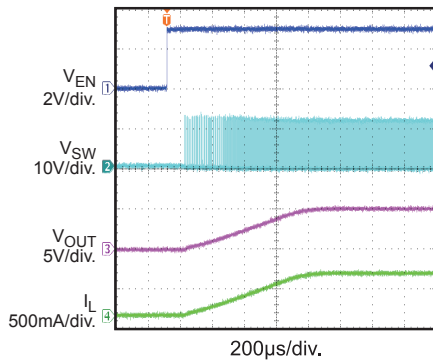
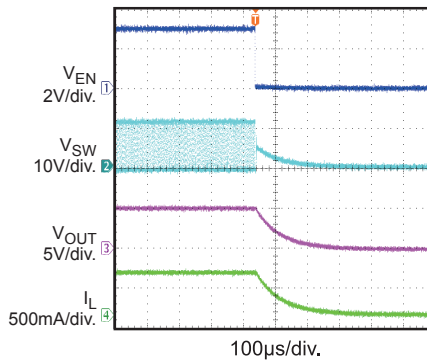
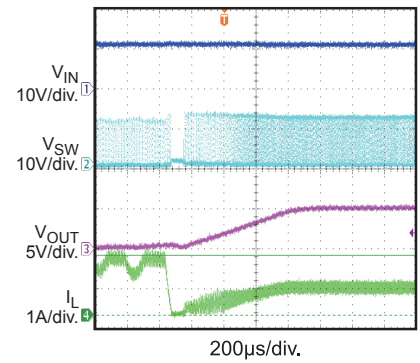
TYPICAL PERFORMANCE CHARACTERISTICS (continued)
Buck Regulator
 $V_{IN} = 12V$, $V_{OUT} = 5V$, $L = 22\mu H$, $T_A = 25^\circ C$, unless otherwise noted.
Enable On
 $I_{OUT} = 0.5A$

Enable Off
 $I_{OUT} = 0.5A$

Short Output Recovery
 $I_{OUT} = 0.65A$

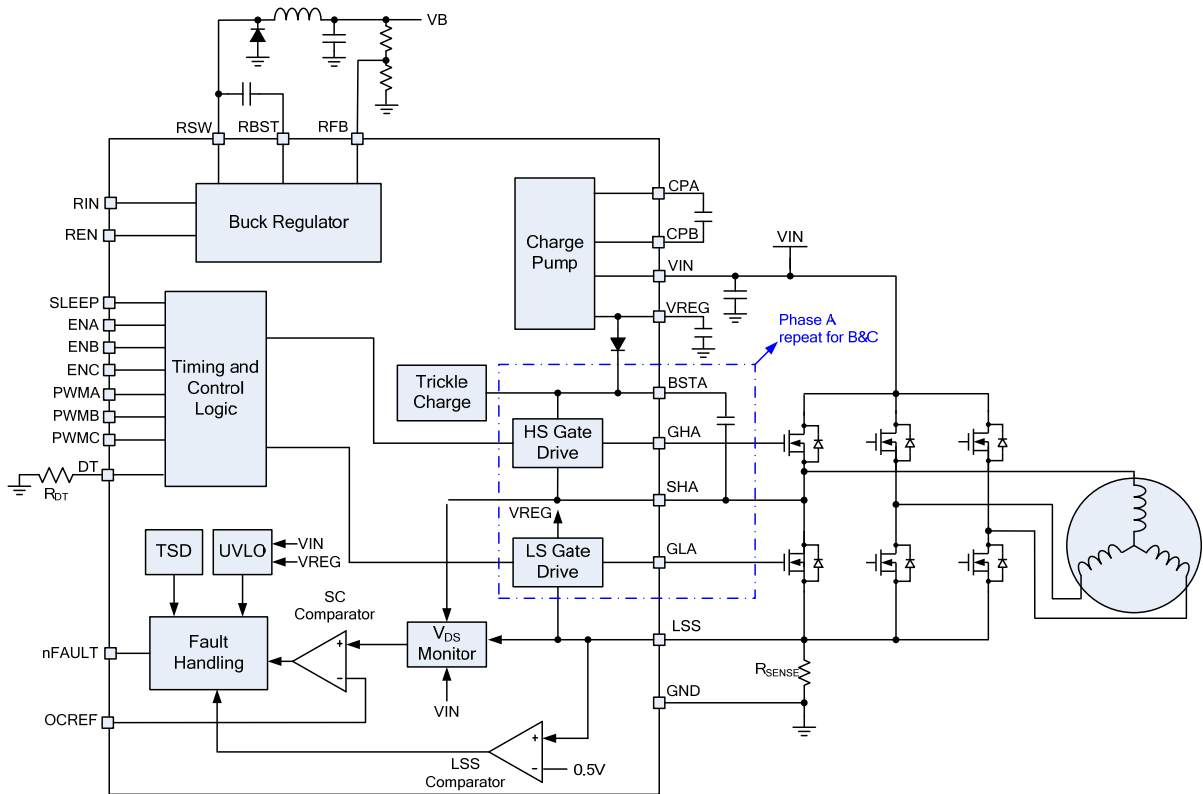
PIN FUNCTIONS

| Pin # | Name | Description |
|------------------|--------|---|
| 1, 26, 30, 36 | NC | Not connected. |
| 2 | BSTC | Bootstrap phase C. Connect a ceramic capacitor to SHC. See Applications Information section. |
| 3 | SHC | High-side source connection phase C. |
| 4 | GHC | High-side gate drive phase C. |
| 5 | GLC | Low-side gate drive phase C. |
| 6 | LSS | Low-side source connection. |
| 7 | PWMC | PWM input pin for phase C. High drives phase C high; low drives phase C low. Internal pull-down. |
| 8 | PWMB | PWM input pin for phase B. High drives phase B high; low drives phase B low. Internal pull-down. |
| 9 | PWMA | PWM input pin for phase A. High drives phase A high; low drives phase A low. Internal pull-down. |
| 10 | ENC | Enable pin for phase C. Active high enables the gate driver for phase C; low disables the gate driver for phase C. Internal pull-down. |
| 11 | ENB | Enable pin for phase B. Active high enables the gate driver for phase B; low disables the gate driver for phase B. Internal pull-down.. |
| 12 | ENA | Enable pin for phase A. Active high enables the gate driver for phase A; low disables the gate driver for phase A. Internal pull-down. |
| 13 | nFAULT | Fault indication. Open-drain output. nFAULT is logic low when in a fault condition. |
| 14 | nSLEEP | Sleep mode input. Logic low to enter low-power sleep mode; high to enable. Internal pull-down. |
| 15 | OCREF | Over-current protection reference input. |
| 16 | DT | Dead time setting. Connect a resistor to ground to set the dead time. See Applications Information section. |
| 17, 34 | GND | Ground. |
| 18 | VIN | Input supply voltage. Bypass to ground with a ceramic capacitor. Additional bulk capacitance may be required. See Applications Information section. |
| 19 | CPA | Charge pump capacitor. Connect a ceramic capacitor between these pins. See Applications Information section. |
| 20 | CPB | |
| 21 | VREG | Gate drive supply output. Connect a ceramic capacitor to ground. See Applications Information section. |
| 22 | BSTA | Bootstrap phase A. Connect a ceramic capacitor to SHA. See Applications Information section. |
| 23 | SHA | High-side source connection phase A. |
| 24 | GLA | Low-side gate drive phase A. |
| 25 | GHA | High-side gate drive phase A. |
| 27 | RBST | Buck regulator boost. Connect a ceramic capacitor between RSW and RBST. |
| 28, 29 | RSW | Buck regulator switch output. |
| 31, 32 | RIN | Buck regulator input (normally connected to VIN). |
| 33 | RFB | Buck regulator feedback input. RFB sets the buck regulator output voltage. Connect RFB to the tap of an external resistor divider from the output to GND. The frequency foldback comparator lowers the oscillator frequency when the FB voltage falls below 250mV to prevent current-limit runaway during a short-circuit fault. |
| 35 | REN | Buck regulator enable. Pull REN above 1.2V to turn the buck regulator on. For automatic enable, connect REN to VIN using a 100kΩ resistor. |
| 37 | BSTB | Bootstrap phase B. Connect a ceramic capacitor to SHB. See Applications Information section. |
| 38 | SHB | High-side source connection phase B. |
| 39 | GHB | High-side gate drive phase B. |
| 40 | GLB | Low-side gate drive phase B. |

BLOCK DIAGRAM

Figure 1: Function Block Diagram

OPERATION

The MP6534 is a three-phase BLDC motor pre-driver that drives three external N-channel MOSFET half bridges, with 0.8A source and 1A sink current capability. It operates over a wide input voltage range of 5V to 60V, generating a boosted gate drive voltage when the input supply is below 12V. The MP6534 features a low-power sleep mode, which disables the device and draws a very low supply current.

The MP6534 provides several flexible functions, such as adjustable dead-time control and over-current protection, which allow the device to cover a wide range of applications.

The MP6534 also integrates a 500mA, step-down, buck regulator. The regulator can be used to generate a low supply voltage for microcontrollers or other logic circuits.

Power-Up Sequence

The power-up sequence is initiated by the application of voltage to VIN pin. To initiate power-up, VIN must be above the undervoltage lockout threshold V_{UVLO} .

After power-up begins, the VREG supply starts operating. VREG must rise above V_{REG_RISE} before the device becomes functional.

The power-up process takes between 1mS and 2mS, after which the MP6534 will respond to logic inputs and drive the outputs.

Gate Drive Power Supplies

Gate drive voltages are generated from the input power, VIN. A regulated charge pump doubler circuit supplies a voltage of approximately 11.5V at the VREG pin. This voltage is used for the low-side gate drive supply. The charge pump requires external capacitors between the CPA and CPB pins, and from VREG to ground.

The high side gate drive is generated by a combination of a bootstrap capacitor and an internal “trickle” charge pump. Bootstrap capacitors are charged to the VREG voltage when the low side MOSFET is turned on. This charge is then used to drive the high side MOSFET gate when it is turned on.

To keep the bootstrap capacitors charged and allow operation at 100% duty cycle, an internal

“trickle” charge pump supplies a small current (about 5 μ A) to overcome leakages that would discharge the bootstrap capacitors.

Refer to the applications information section for details on the selection of external components.

Sleep Mode (nSLEEP Input)

Driving nSLEEP low will put the device into a low-power sleep state. In this state, all the internal circuits are disabled, and all inputs are ignored. nSLEEP has an interval pulldown, so it must be driven high for the device to operate.

When exiting sleep mode, the part will initiate the power-up sequence described above.

Input Logic

The ENx input pins controls both the high- and low-side gate drive outputs of each phase. When ENx is low, the gate drive outputs are pulled low, and the PWMx input of that phase is ignored. When ENx is high, the gate drive outputs are enabled, and the PWM input is recognized. Refer to Table 1 for the logic truth table.

Table 1: Input Logic Truth Table

| ENx | PWMx | SHx |
|-----|------|----------------|
| H | H | VIN |
| H | L | GND |
| L | x | High impedance |

Low-side Automatic Turn-on

To ensure that the bootstrap capacitor is charged enough to turn on the high-side MOSFET, each time that the ENx pin transitions from low to active high, the low-side MOSFET for that phase is turned on for a short pulse (t_{LS}). This occurs regardless of the state of the PWMx input pin.

nFAULT

The nFAULT output pin reports to the system when a fault condition (such as an output short circuit, overcurrent, or overtemperature) is detected. nFAULT is an open-drain output, and it is driven low when a fault condition occurs. If the fault condition is released, nFAULT is pulled high by an external pull-up resistor.

Short Circuit Protection (V_{DS} Sensing)

To protect the power stage from damage due to high currents, a VDS sensing circuitry is implemented in the MP6534. The voltage drop across each MOSFET is sensed. (This voltage is

proportional to the R_{DS-ON} of the MOSFET and the I_{DS} current passing through it). If this voltage exceeds the voltage supplied to the OCREF terminal, a short circuit is recognized.

In the event of a short circuit, the MP6534 disables all of the gate drive outputs. nFAULT is driven active low. The device will stay latched off until it is reset by nSLEEP or VIN UVLO.

Short circuit protection can be disabled by connection a 100k Ω resistor from VREG to the OCREF pin.

Over-current Protection (OCP)

The MP6534 can implement output overcurrent protection (OCP) by monitoring the current through a low-side shunt resistor connected to the low-side MOSFETs. This resistor is connected to the LSS input pin and the low-side MOSFET source terminals. If the OCP function is not desired, the LSS pin and MOSFET source terminals should all be connected directly to ground.

If the LSS voltage (the voltage across the shunt resistor) exceeds the LSS OCP threshold voltage V_{LSS-OC} , an OCP event is recognized. Once an OCP event is detected, the MP6534 will enter a latched fault state and disable all functions. The device will stay latched off until it is reset by nSLEEP or VIN UVLO.

The OCP current limit level is selected by the value of the current sense resistor at LSS pin. Refer to the applications information section for more information.

OCP protection can be disabled by connection a 100k Ω resistor from VREG to the OCREF pin.

Short-circuit and OCP Deglitch Time

There is often a current spike during switching transitions, due to body diode reverse-recovery current or the distributed capacitance of the load. This current spike requires filtering to prevent it from erroneously triggering OCP. An internal fixed deglitch time (t_{OC}) blanks the output of the VDS monitor when the outputs are switched.

Dead-Time Adjustment

To prevent shoot-through in any phase of the bridge, it is necessary to have a dead time (t_{DEAD}) between a high- or low-side turn-off and the next complementary turn-on event. The dead time for

all three phases is set by a single dead-time resistor (R_{DT}) between DT and ground with Equation (1):

$$t_{DEAD}(nS) = 3.7 * R(k\Omega) \quad (1)$$

If DT is tied to directly to ground, an internal minimum dead time (30ns) will be applied. Leaving DT open generates approximately a 6 μ s dead time.

UVLO Protection

If at any time the voltage on VIN falls below the undervoltage lockout threshold V_{IN_RISE} , all circuitry in the device is disabled and the internal logic will be reset.

Operation will resume with the power-up sequence when VIN rises above the UVLO thresholds.

After power-up, if the voltage on VREG drops below the V_{REG_RISE} threshold, the MP6534 will enter a latched fault state and disable all functions. The nFAULT pin will be driven active low. The device will stay latched off until it is reset by nSLEEP or VIN UVLO.

Thermal Shutdown

If the die temperature exceeds safe limits, the MP6534 will enter a latched fault state and disable all functions. The device will stay latched off until it is reset by nSLEEP or VIN UVLO.

Buck Regulator Operation

The buck regulator in the MP6534 is a current-mode buck regulator. The EA output voltage is proportional to the peak inductor current.

At the beginning of a cycle, M1 is off. The EA output voltage is higher than the current sense amplifier output, and the current comparator's output is low. The rising edge of the 480kHz CLK signal sets the RS flip-flop. Its output turns on M1, connecting SW and the inductor to the input supply.

The increasing inductor current is sensed and amplified by the current sense amplifier. Ramp compensation is summed to the current sense amplifier output and compared to the error amplifier output by the PWM comparator. When the sum of the current sense amplifier output and the slope compensation signal exceed the EA output voltage, the RS flip-flop is reset and M1 is

turned off. The external Schottky rectifier diode conducts the inductor current.

If the sum of the current sense amplifier output and the slope compensation signal does not exceed the EA output for an entire cycle, then the falling edge of the CLK resets the flip-flop.

The output of the error amplifier integrates the voltage difference between feedback and the 0.81V bandgap reference. The polarity is such that a FB voltage lower than 0.81V increases the EA output voltage. Since the EA output voltage is proportional to the peak inductor current, an increase in its voltage also increases current delivered to the output.

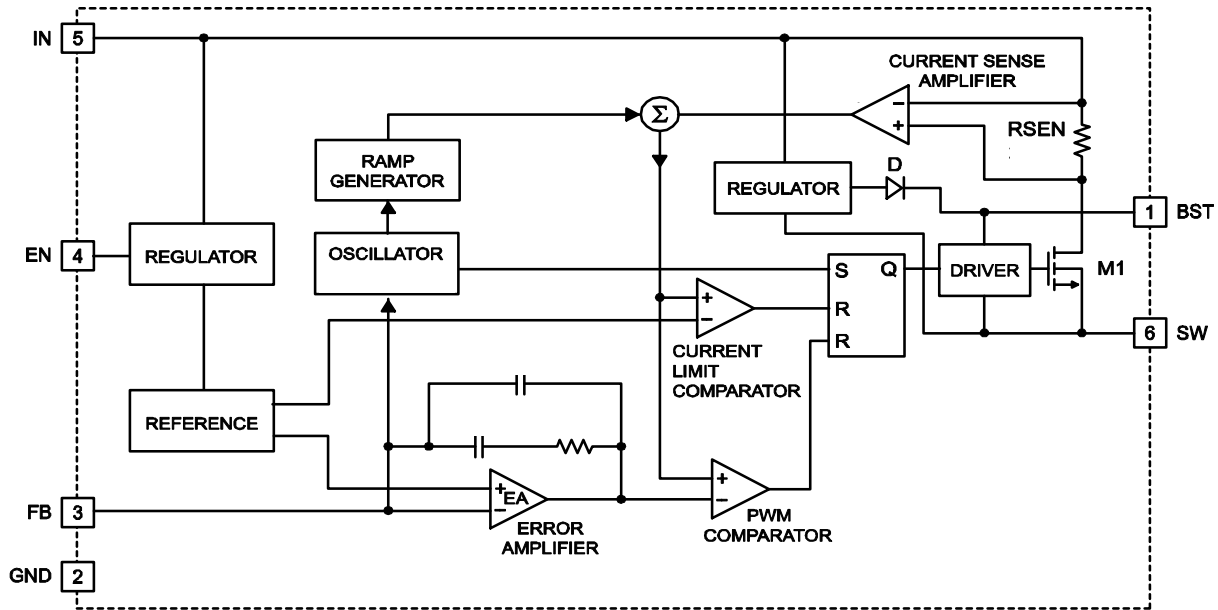

Figure 2: Functional Block Diagram of Buck Regulator

GATE DRIVER APPLICATIONS INFORMATION

VIN Input Voltage

The VIN pin supplies all power to the device. It must be properly bypassed with a capacitor to ground – see below for specific recommendations.

The normal operating range of VIN is between 5V and 60V.

VIN should never be allowed to exceed the absolute maximum ratings, even in a short term transient condition, or damage to the device may result. In some cases – especially where mechanical energy can turn a motor into a generator – it may be necessary to use some form of overvoltage protection, such as a TVS diode, between VIN and ground.

Component Selection

MOSFET selection

Correctly selecting the power MOSFETs used to drive a motor is crucial to designing a successful motor drive.

The first requirement is that the MOSFET must have a VDS breakdown voltage that is higher than the supply voltage. It is recommended that considerable margin – 10-15 volts - be added to prevent MOSFET damage from transient voltages that can be caused by parasitic inductances in the PCB layout and wiring. For example, for 24V power supply applications, MOSFETs having a breakdown voltage of 40V-60V minimum are recommended. More margin is desirable in high current applications, as the transients caused by parasitic inductances may be larger. Also, there are conditions like regenerative braking that can inject current back into the power supply; care must be taken that this does not cause an increase in the power supply voltage large enough to damage components.

The MOSFETs must be able to safely pass the current needed to run the motor. The highest current condition, which is normally when the motor is first started or stalled, needs to be supported. This is typically called the “stall current” of the motor.

Related to the current capability of the MOSFET is the $r_{ds(on)}$. This is the resistance of the MOSFET when it is in the fully “turned on” state. The MOSFET will dissipate power proportional to the $r_{ds(on)}$ and the motor current: $P=I^2R$. The $r_{ds(on)}$ needs to be selected so that for the desired motor current, the heat generated in this power can be safely dissipated. In some cases, this may require special PCB design considerations and/or external heatsinks to be used for the MOSFETs.

Some consideration should be made for the safe operating area (SOA) of the MOSFETs in fault conditions, such as a short circuit. The IC will act quickly in the event of a short, but there is still a very short time (on the order of 3 μ S) where large currents can flow in the MOSFETs while the protection circuits recognize the fault and disable the outputs.

External Capacitor Selection

The MP6534 has a unique feature in that it can provide a gate drive voltage (VREG) of 10-12V even if the input supply voltage drops as low as 5V. This gate drive voltage is generated by a charge pump inside the part, which uses external capacitors.

The charge pump flying capacitor, C_{CP} , should have a capacitance of 470nF. It needs to be rated to withstand the maximum VIN power supply voltage. An X7R or X5R ceramic capacitor is recommended. With a 470nF capacitor, VREG can output approximately 10mA when VIN is 5V. If operation below 10V is not needed, a 220nF capacitor can be used

To provide the large peak currents needed to turn on the HS MOSFET, bootstrap capacitors are used. These capacitors are charged when the output is driven low, then the charge in the bootstrap capacitor is used to turn on the HS MOSFET when the output is driven high. (Note that an internal charge pump will keep the bootstrap capacitor charged when the output is held high for an extended period).

The bootstrap capacitors are selected depending on the MOSFET total gate charge. When the HS MOSFET is turned on, the charge stored in the bootstrap capacitor is transferred to the HS MOSFET gate. As a simplified approximation, the minimum bootstrap capacitance can be

estimated as $C_{BOOT} > 8 \cdot Q_G$, where Q_G is the total gate charge of the MOSFET in nC, and C_{BOOT} is in nF. The bootstrap capacitors should not exceed $1\mu\text{F}$, or they may cause improper operation at start-up.

For most applications, bootstrap capacitors between $0.1\mu\text{F}$ and $1\mu\text{F}$, X5R or X7R ceramic, rated for 25V minimum, are recommended.

The VREG pin requires a bypass capacitor to ground of $10\mu\text{F}$. This should be an X7R or X5R ceramic capacitor rated for 16V minimum.

VIN requires a bypass capacitor to ground, placed as close as possible to the device. At a minimum, a $0.1\mu\text{F}$ X5R or X7R ceramic capacitor, rated for the VIN voltage, is recommended.

Depending on the power supply impedance and the distance between the MOSFETs and the power supply, additional bulk capacitance is usually needed. Between $47\mu\text{F}$ and $470\mu\text{F}$ of low ESR electrolytic capacitors are typically used.

Dead Time Resistor Selection

During the transition between driving an output low and high, there is a short period when neither the HS nor LS MOSFET is turned on. This period, called “dead time”, is needed to prevent any overlap in conduction between HS and LS MOSFETs, which would effectively provide a short-circuit directly between the power supply and ground. This condition, referred to as “shoot-through”, causes large transient currents, and can destroy the MOSFETs.

Since motors are inductive by nature, once current is flowing in the motor, it cannot stop immediately, even if the MOSFETs are turned off. This “recirculation current” continues to flow in the original direction until the magnetic field has decayed.

When the MOSFETs are turned off, this current will flow through the “body diode” which is inherent in the MOSFET device.

MOSFET body diodes have a much higher voltage drop than the MOSFET has during conduction, so there more power dissipated in body diode conduction than during the on time. Because of this, it is desirable to minimize the dead time. However, the dead time must be made large enough to guarantee under all

conditions that the HS and LS MOSFETs are never turned on at the same time.

Dead time can be set over a large range, by selecting the value of the external resistor that is connected to the DT pin. Usually, a good starting point is a dead time of about $1\mu\text{S}$, which requires a 200k resistor on the DT pin. If faster switching and/or a high PWM frequency (over $\sim 30\text{kHz}$) is used, shorter dead time may be desirable; if switching is slowed using external gate resistors, longer dead time may be needed.

The waveform below shows about a 300nS dead time between the LS gate turn-off and the HS gate turn-on.

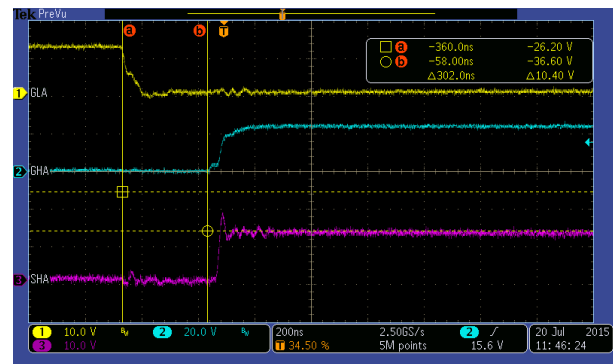

LSS Resistor Selection

If the voltage applied to the LSS pin ever exceeds 500mV, an overcurrent event will be recognized. The external sense resistor is sized to provide less than 500mV drop at the maximum expected motor current. For example, if a 50 mΩ resistor is used, a current of 10 amps would cause a 500mV drop, and activate the overcurrent protection.

If this function is not needed, connect LSS directly to ground.

OCREF Voltage Selection

An internal comparator compares the voltage drop across each MOSFET with a voltage that is externally provided on the OCREF input pin. This voltage is normally provided by an external resistor divider from a convenient power supply. If the drop across any MOSFET ever exceeds the voltage on the OCREF pin, a short-circuit event is recognized.

If this function is not needed, connect OCREF to VREG through a 100k resistor.

Gate Drive Considerations

The gate characteristics of the selected MOSFETs will affect how fast they will be switched and off. The gate drive outputs of the device can be connected directly to the gates of the power MOSFETs, which results in the fastest possible turn-on and turn-off times. However, it may be advantageous to add external components (resistors and/or diodes) to modify the MOSFET turn-on and turn-off characteristics.

Adding external series resistance – typically between 10 and 100 ohms – will limit the current that charges and discharges the gate of the MOSFET, which will slow down the turn-on and turn-off times. Sometimes this is desirable to control EMI and noise. Slowing the transition down too much, however, results in large power dissipation in the MOSFET during switching.

In some cases, it is desirable to have a slow turn-on, but a fast turn-off. This can be implemented by using a series resistor in parallel with a diode. At turn-on, the resistor limits the current flow into the gate; at turn-off, the gate is discharged quickly through the diode.

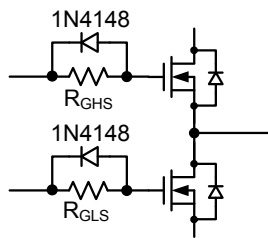

This waveform below shows the gates of the LS and HS MOSFETs, and the phase node (output) with no series resistance. You can see that the gates transition quickly. The resulting rise time on the phase node is quite fast. Note the scale of 100nS/div.

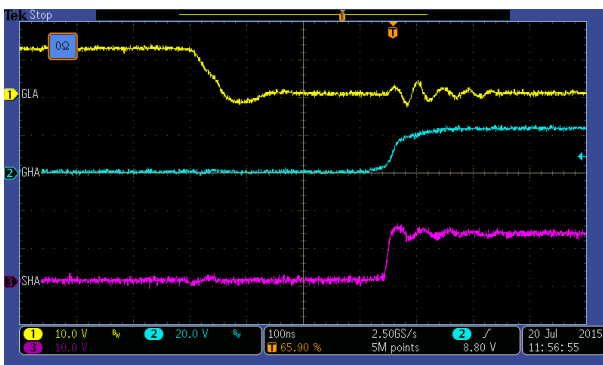

This waveform shows the effect of adding a 100Ω series resistor between the GLA and GLH pins and the MOSFET gates. Rise time on the phase node has been slowed significantly. The scale here is 200nS/div.

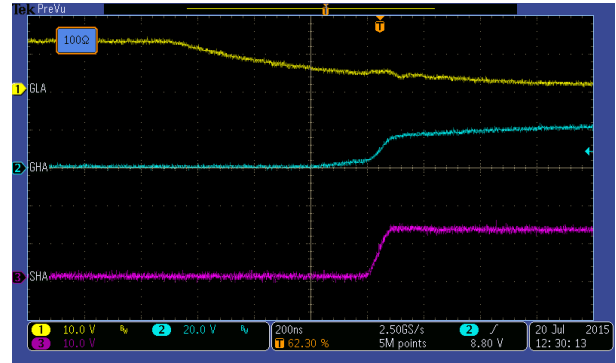

This waveform shows the effect of adding a 1N4148 diode in parallel with the 100Ω resistors (with the cathode connected to the IC). You can see that the fall time of the LS gate is quite fast compared to the HS gate rise time. The phase node moves even slower, because of a longer period of time between when the LS FET is turned off, and the HS FET is turned on.

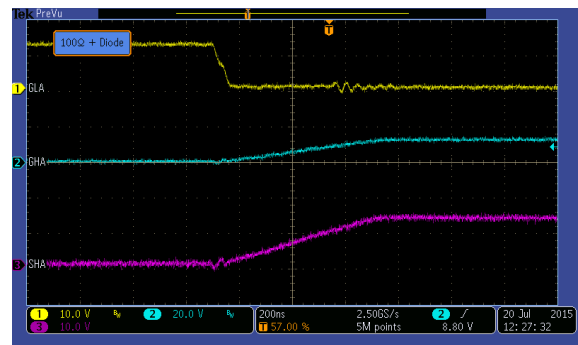

PCB Layout

Proper PCB layout is critical to the performance of MOSFET gate drivers. In particular, the connection between the HS source and LS drain needs to be as direct as possible, to avoid negative undershoot on the phase node due to parasitic inductances. The pre-driver is designed to accommodate negative undershoot, but if it is excessive, unpredictable operation or damage to the IC can result.

An example PCB layout (the MP6530 is shown, which is similar to the MP6534) is shown below. It uses surface mount N-channel MOSFETs, which allows very short connection between the HS and LS MOSFETs. You can also see the use

of wide copper areas for all of the high current paths.

The low-side sense resistor is composed of three resistors in parallel (R25, R26, and R27), and is connected to the input supply and LS MOSFET source terminals by wide copper areas.

Note the location of the charge pump and supply bypass capacitors, very close to the IC. The grounded side of these capacitors is connected to a ground plane, which is connected to the device ground pin and exposed pad. The high-current ground path between the input supply, input bulk capacitor C19, and MOSFETs is kept away from this area.

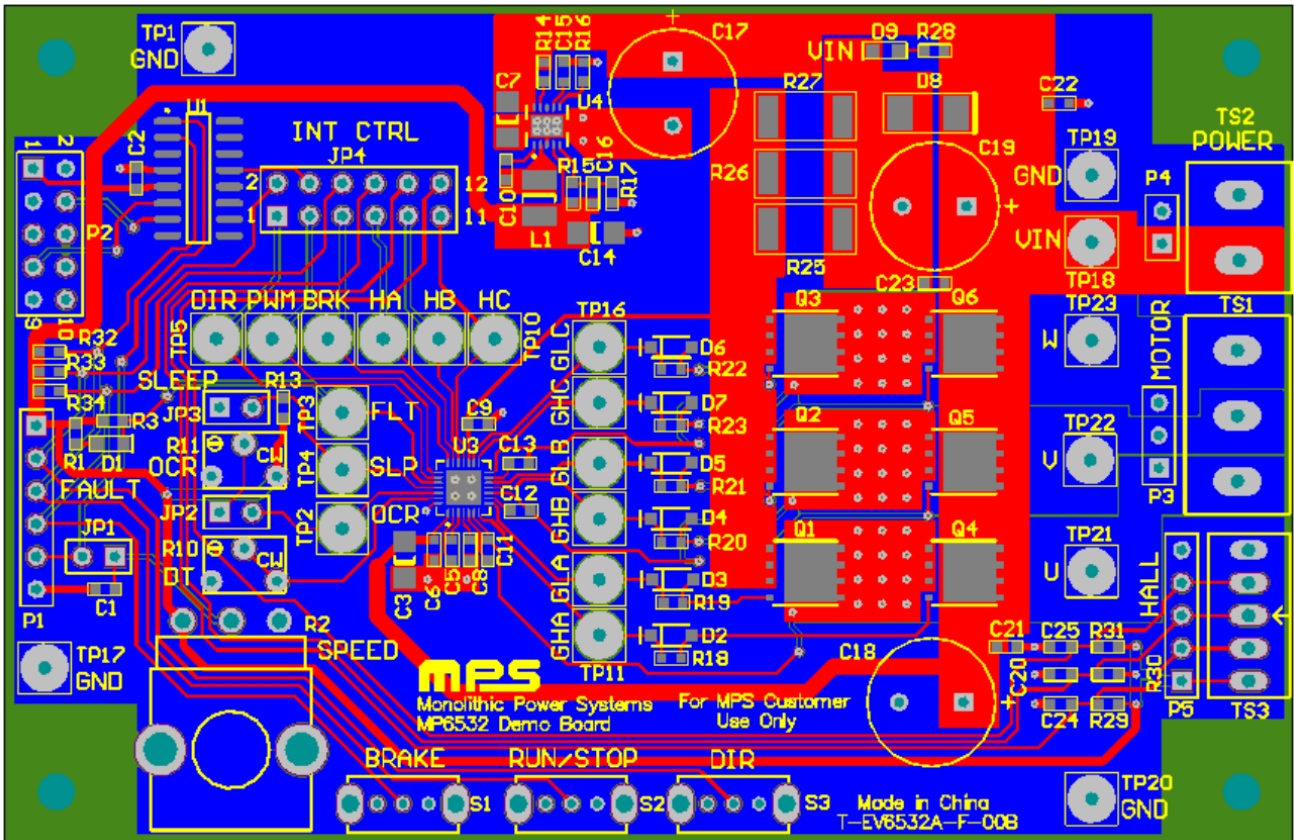

BUCK REGULATOR APPLICATION INFORMATION

Setting the Output Voltage

The external resistor divider sets the output voltage (see the Typical Application schematic). Table 2 lists resistors for common output voltages. The feedback resistor (R1) also sets the feedback loop bandwidth with the internal compensation capacitor (see Figure 2). R2 can be calculated with Equation (2):

$$R2 = \frac{R1}{\frac{V_{OUT}}{0.81V} - 1} \quad (2)$$

Table 2: Resistor Selection for Common Output Voltages

| V _{OUT} (V) | R1 (kΩ) | R2 (kΩ) |
|----------------------|-----------|-----------|
| 1.8 | 80.6 (1%) | 64.9 (1%) |
| 2.5 | 49.9 (1%) | 23.7 (1%) |
| 3.3 | 49.9 (1%) | 16.2 (1%) |
| 5 | 49.9 (1%) | 9.53 (1%) |

Selecting the Inductor

For most applications, use an inductor with a DC current rating at least 25% higher than the maximum load current. For best efficiency, the inductor's DC resistance should be less than 200mΩ. For most designs, the required inductance value can be derived from Equation (3):

$$L = \frac{V_{OUT} \times (V_{IN} - V_{OUT})}{V_{IN} \times \Delta I_L \times f_{SW}} \quad (3)$$

Where ΔI_L is the inductor ripple current.

Choose the inductor ripple current to be 30% of the maximum load current. The maximum inductor peak current can be calculated with Equation (4):

$$I_{L(MAX)} = I_{LOAD} + \frac{\Delta I_L}{2} \quad (4)$$

Under light-load conditions (below 100mA), use a larger inductance to improve efficiency.

Selecting the Input Capacitor

The input capacitor reduces the surge current drawn from the input supply and the switching noise from the device. The input capacitor impedance at the switching frequency should be less than the input source impedance to prevent high frequency switching current from passing through the input. Ceramic capacitors with X5R or X7R dielectrics are recommended for their low ESR and small temperature coefficients. For most applications, a 4.7μF capacitor is sufficient.

Selecting the Output Capacitor

The output capacitor keeps the output voltage ripple small and ensures feedback loop stability. The output capacitor impedance should be low at the switching frequency. Use ceramic capacitors with X5R or X7R dielectrics for their low ESR characteristics. For most applications, a 22μF ceramic capacitor is sufficient.

PCB Layout Guide

Efficient PCB layout is critical for stable operation. For best results, follow the guidelines below.

- 1) Keep the path of the switching current short.
- 2) Minimize the loop area formed by the input capacitor, high-side MOSFET, and Schottky diode.
- 3) Keep the connection from the power ground to the Schottky diode to RSW as short and wide as possible.
- 4) Ensure that all feedback connections are short and direct.
- 5) Place the feedback resistors and compensation components as close to the chip as possible.
- 6) Route RSW away from sensitive analog nodes such as RFB.

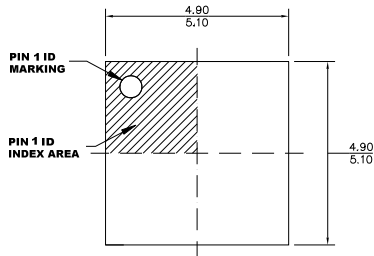
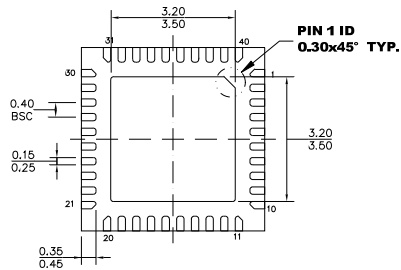
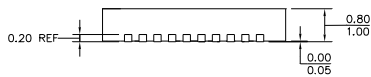
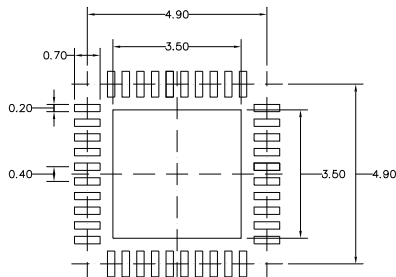
PACKAGE INFORMATION
QFN-40 (5mmx5mm)

TOP VIEW

BOTTOM VIEW

SIDE VIEW

RECOMMENDED LAND PATTERN
NOTE:

- 1) ALL DIMENSIONS ARE IN MILLIMETERS.
- 2) EXPOSED PADDLE SIZE DOES NOT INCLUDE MOLD FLASH.
- 3) LEAD COPLANARITY SHALL BE 0.08 MILLIMETERS MAX.
- 4) DRAWING CONFIRMS TO JEDEC MO-220, VARIATION VHHE-1
- 5) DRAWING IS NOT TO SCALE.

NOTICE: The information in this document is subject to change without notice. Please contact MPS for current specifications. Users should warrant and guarantee that third party Intellectual Property rights are not infringed upon when integrating MPS products into any application. MPS will not assume any legal responsibility for any said applications.