

Application

- Brushed Motor drive applications
- BLDC Motor drive applications
- Battery powered circuits
- Half-bridge and full-bridge topologies
- Synchronous rectifier applications
- Resonant mode power supplies
- OR-ing and redundant power switches
- DC/DC and AC/DC converters
- DC/AC Inverters

HEXFET® Power MOSFET

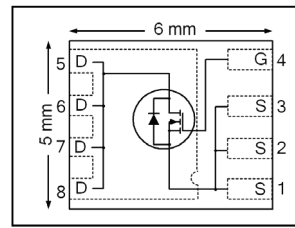

V_{DSS}	60V
$R_{DS(on)}$ typ.	4.3mΩ
	max
I_D	85A

Benefits

- Improved Gate, Avalanche and Dynamic dV/dt Ruggedness
- Fully Characterized Capacitance and Avalanche SOA
- Enhanced body diode dV/dt and dI/dt Capability
- Lead-Free, RoHS Compliant



Base part number	Package Type	Standard Pack		Orderable Part Number
		Form	Quantity	
IRFH7545PbF	PQFN 5mm x 6mm	Tape and Reel	4000	IRFH7545TRPbF

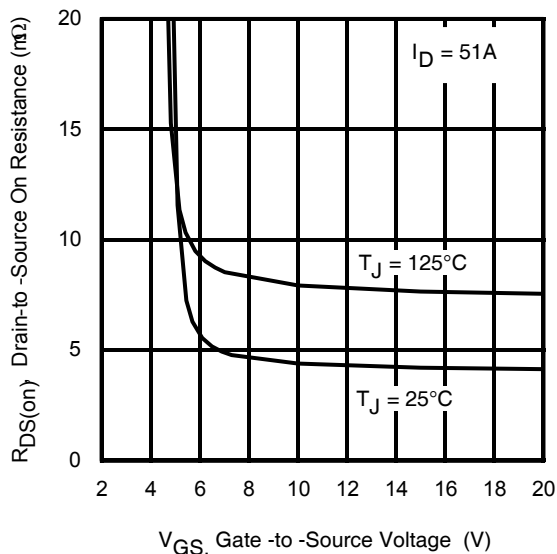

Fig 1. Typical On-Resistance vs. Gate Voltage

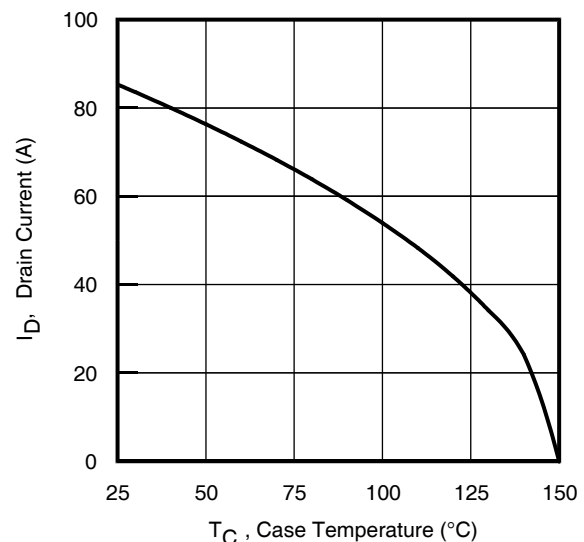

Fig 2. Maximum Drain Current vs. Case Temperature

Absolute Maximum Rating

Symbol	Parameter	Max.	Units
$I_D @ T_{C(\text{Bottom})} = 25^\circ\text{C}$	Continuous Drain Current, $V_{GS} @ 10\text{V}$	85	A
$I_D @ T_{C(\text{Bottom})} = 100^\circ\text{C}$	Continuous Drain Current, $V_{GS} @ 10\text{V}$	54	
I_{DM}	Pulsed Drain Current ①	340	
$P_D @ T_C = 25^\circ\text{C}$	Maximum Power Dissipation	83	W
	Linear Derating Factor	0.67	W/°C
V_{GS}	Gate-to-Source Voltage	± 20	V
T_J T_{STG}	Operating Junction and Storage Temperature Range	-55 to + 150	°C

Avalanche Characteristics

E_{AS} (Thermally limited)	Single Pulse Avalanche Energy ②	102	mJ
E_{AS} (Thermally limited)	Single Pulse Avalanche Energy ③	160	
I_{AR}	Avalanche Current ①	See Fig 15, 16, 23a, 23b	A
E_{AR}	Repetitive Avalanche Energy ①		mJ

Thermal Resistance

Symbol	Parameter	Typ.	Max.	Units
$R_{\theta JC}$ (Bottom)	Junction-to-Case ⑦	—	1.5	°C/W
$R_{\theta JC}$ (Top)	Junction-to-Case ⑦	—	22	
$R_{\theta JA}$	Junction-to-Ambient ⑨	—	34	
$R_{\theta JA}$ (<10s)	Junction-to-Ambient ⑨	—	23	

Static @ $T_J = 25^\circ\text{C}$ (unless otherwise specified)

Symbol	Parameter	Min.	Typ.	Max.	Units	Conditions
$V_{(BR)DSS}$	Drain-to-Source Breakdown Voltage	60	—	—	V	$V_{GS} = 0\text{V}, I_D = 250\mu\text{A}$
$\Delta V_{(BR)DSS}/\Delta T_J$	Breakdown Voltage Temp. Coefficient	—	49	—	mV/°C	Reference to $25^\circ\text{C}, I_D = 1\text{mA}$ ①
$R_{DS(on)}$	Static Drain-to-Source On-Resistance	—	4.3	5.2	mΩ	$V_{GS} = 10\text{V}, I_D = 51\text{A}$
		—	6.0	—		$V_{GS} = 6.0\text{V}, I_D = 26\text{A}$
$V_{GS(th)}$	Gate Threshold Voltage	2.1	—	3.7	V	$V_{DS} = V_{GS}, I_D = 100\mu\text{A}$
I_{DSS}	Drain-to-Source Leakage Current	—	—	1.0	μA	$V_{DS} = 60\text{V}, V_{GS} = 0\text{V}$
		—	—	150		$V_{DS} = 60\text{V}, V_{GS} = 0\text{V}, T_J = 125^\circ\text{C}$
I_{GSS}	Gate-to-Source Forward Leakage	—	—	100	nA	$V_{GS} = 20\text{V}$
	Gate-to-Source Reverse Leakage	—	—	-100		$V_{GS} = -20\text{V}$
R_G	Gate Resistance	—	2.5	—	Ω	

Notes:

- ① Repetitive rating; pulse width limited by max. junction temperature.
- ② Limited by T_{Jmax} , starting $T_J = 25^\circ\text{C}$, $L = 78\mu\text{H}$, $R_G = 50\Omega$, $I_{AS} = 51\text{A}$, $V_{GS} = 10\text{V}$.
- ③ $I_{SD} \leq 51\text{A}$, $di/dt \leq 1212\text{A}/\mu\text{s}$, $V_{DD} \leq V_{(BR)DSS}$, $T_J \leq 175^\circ\text{C}$.
- ④ Pulse width $\leq 400\mu\text{s}$; duty cycle $\leq 2\%$.
- ⑤ C_{oss} eff. (TR) is a fixed capacitance that gives the same charging time as C_{oss} while V_{DS} is rising from 0 to 80% V_{DSS} .
- ⑥ C_{oss} eff. (ER) is a fixed capacitance that gives the same energy as C_{oss} while V_{DS} is rising from 0 to 80% V_{DSS} .
- ⑦ R_θ is measured at T_J approximately 90°C .
- ⑧ Limited by T_{Jmax} , starting $T_J = 25^\circ\text{C}$, $L = 1\text{mH}$, $R_G = 50\Omega$, $I_{AS} = 18\text{A}$, $V_{GS} = 10\text{V}$.
- ⑨ When mounted on 1 inch square PCB (FR-4). Please refer to AN-994 for more details:

<http://www.irf.com/technical-info/appnotes/an-994.pdf>

Dynamic Electrical Characteristics @ $T_J = 25^\circ\text{C}$ (unless otherwise specified)

Symbol	Parameter	Min.	Typ.	Max.	Units	Conditions
gfs	Forward Transconductance	140	—	—	S	$V_{DS} = 10\text{V}$, $I_D = 51\text{A}$
Q_g	Total Gate Charge	—	73	110	nC	$I_D = 51\text{A}$ $V_{DS} = 30\text{V}$ $V_{GS} = 10\text{V}$
Q_{gs}	Gate-to-Source Charge	—	19	—		
Q_{gd}	Gate-to-Drain Charge	—	22	—		
Q_{sync}	Total Gate Charge Sync. ($Q_g - Q_{gd}$)	—	51	—		
$t_{d(on)}$	Turn-On Delay Time	—	8.6	—	ns	$V_{DD} = 30\text{V}$ $I_D = 51\text{A}$ $R_G = 2.7\Omega$ $V_{GS} = 10\text{V}$ ④
t_r	Rise Time	—	26	—		
$t_{d(off)}$	Turn-Off Delay Time	—	43	—		
t_f	Fall Time	—	16	—		
C_{iss}	Input Capacitance	—	3890	—	pF	$V_{GS} = 0\text{V}$ $V_{DS} = 25\text{V}$ $f = 1.0\text{MHz}$, See Fig.7 $V_{GS} = 0\text{V}$, $V_{DS} = 0\text{V}$ to 48V ⑥ $V_{GS} = 0\text{V}$, $V_{DS} = 0\text{V}$ to 48V ⑤
C_{oss}	Output Capacitance	—	365	—		
C_{riss}	Reverse Transfer Capacitance	—	220	—		
$C_{oss\text{ eff.}(ER)}$	Effective Output Capacitance (Energy Related)	—	370	—		
$C_{oss\text{ eff.}(TR)}$	Output Capacitance (Time Related)	—	470	—		

Diode Characteristics

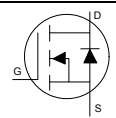
Symbol	Parameter	Min.	Typ.	Max.	Units	Conditions
I_S	Continuous Source Current (Body Diode)	—	—	85	A	MOSFET symbol showing the integral reverse p-n junction diode. 
I_{SM}	Pulsed Source Current (Body Diode) ①	—	—	340		
V_{SD}	Diode Forward Voltage	—	—	1.2	V	$T_J = 25^\circ\text{C}$, $I_S = 51\text{A}$, $V_{GS} = 0\text{V}$ ④
dv/dt	Peak Diode Recovery dv/dt ④	—	8.1	—	V/ns	$T_J = 150^\circ\text{C}$, $I_S = 51\text{A}$, $V_{DS} = 60\text{V}$ ④
t_{rr}	Reverse Recovery Time	—	32	—	ns	$V_{DD} = 51\text{V}$ $I_F = 51\text{A}$, $di/dt = 100\text{A}/\mu\text{s}$ ④
		—	34	—		
Q_{rr}	Reverse Recovery Charge	—	30	—	nC	$T_J = 25^\circ\text{C}$ $T_J = 125^\circ\text{C}$
		—	38	—		
I_{RRM}	Reverse Recovery Current	—	1.7	—	A	$T_J = 25^\circ\text{C}$

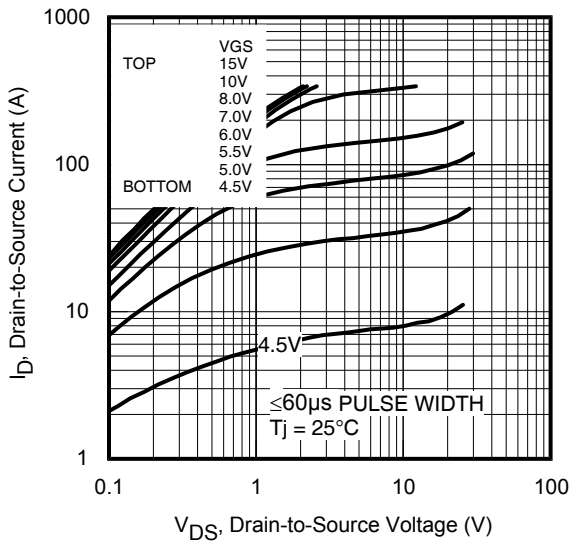
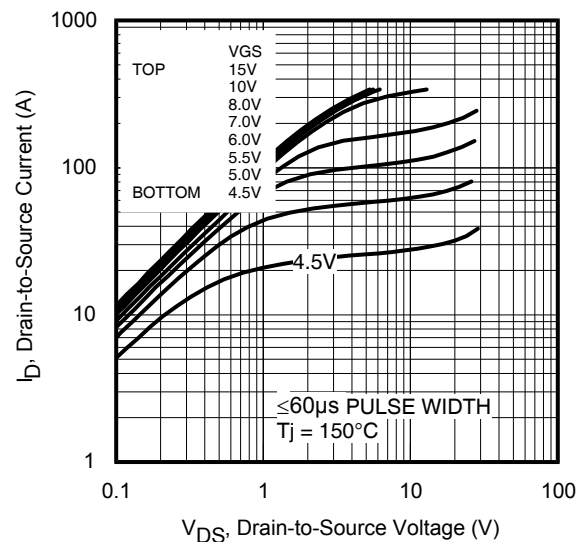
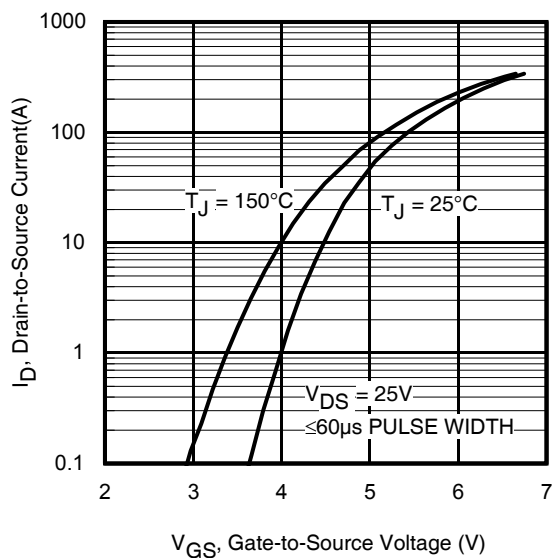
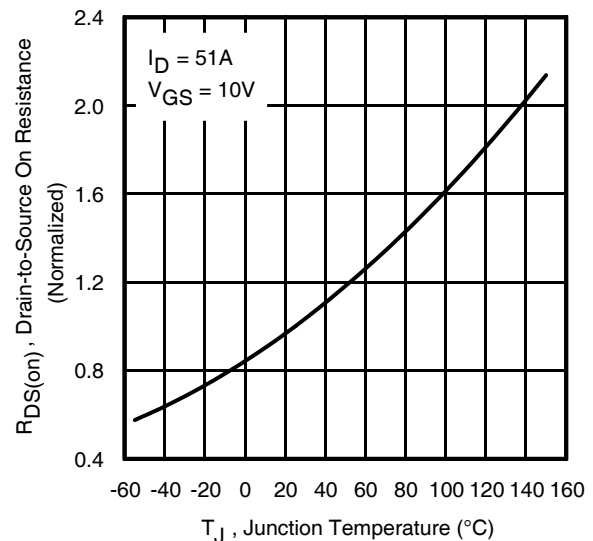
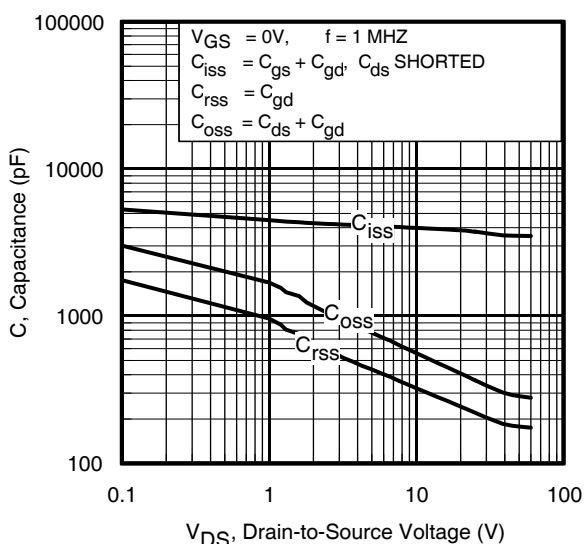
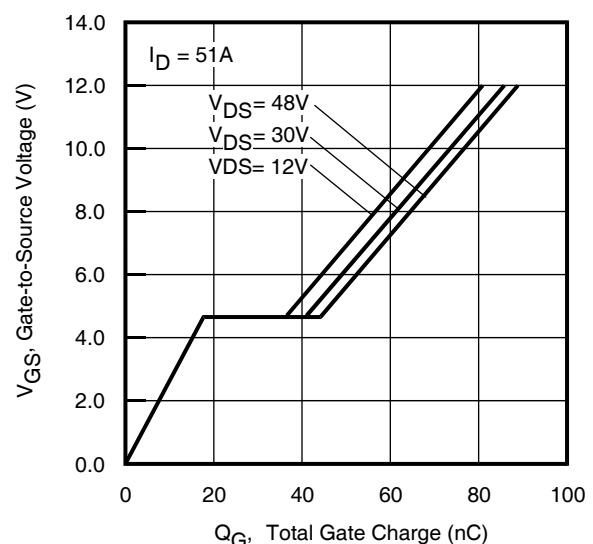
Fig 3. Typical Output Characteristics

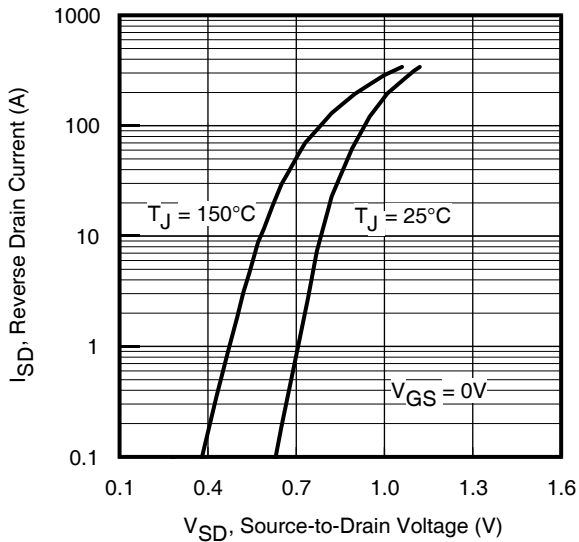
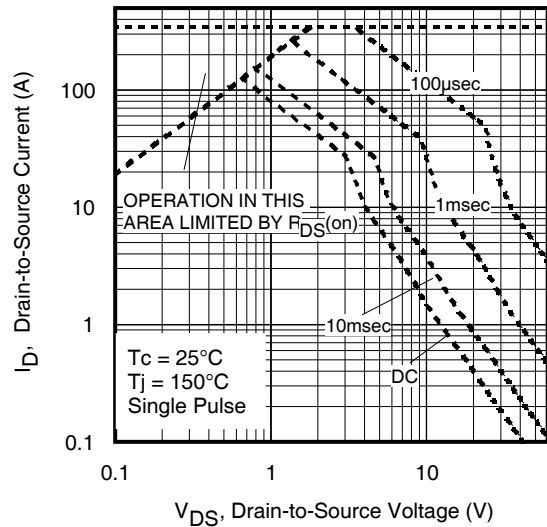
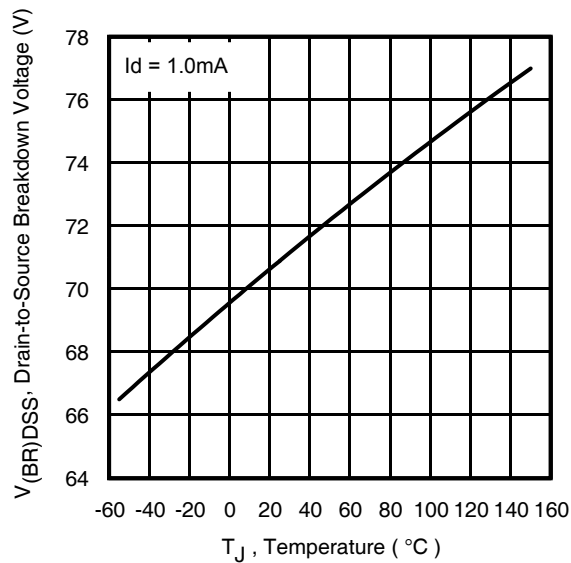
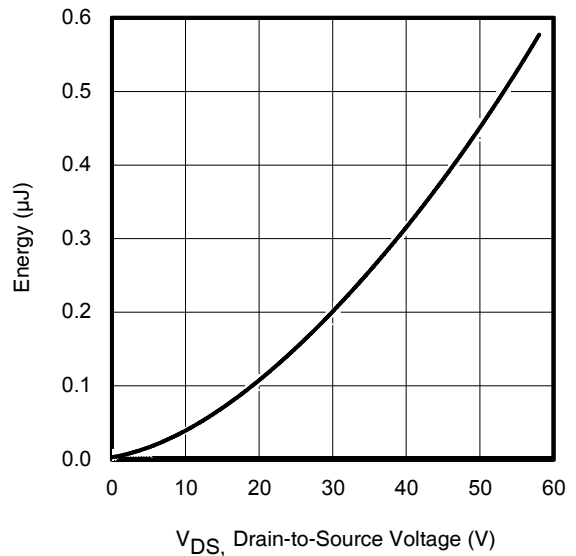
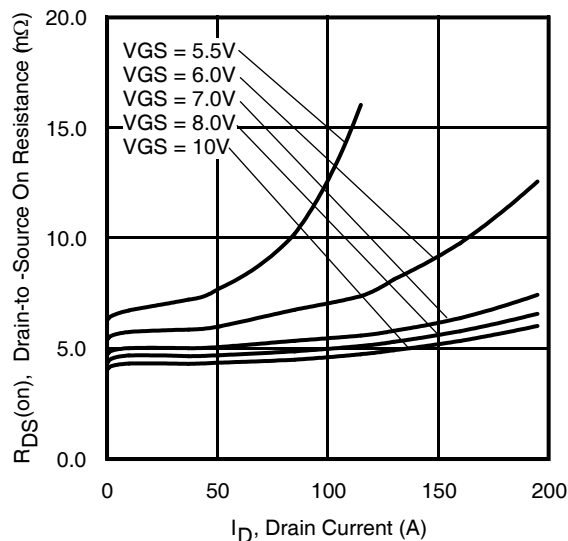
Fig 4. Typical Output Characteristics

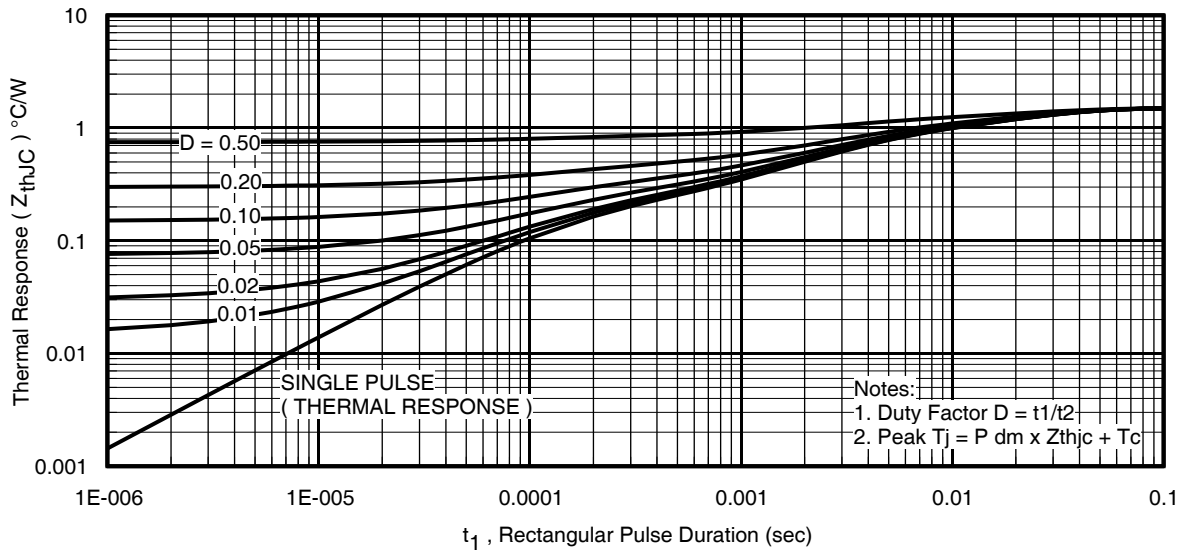
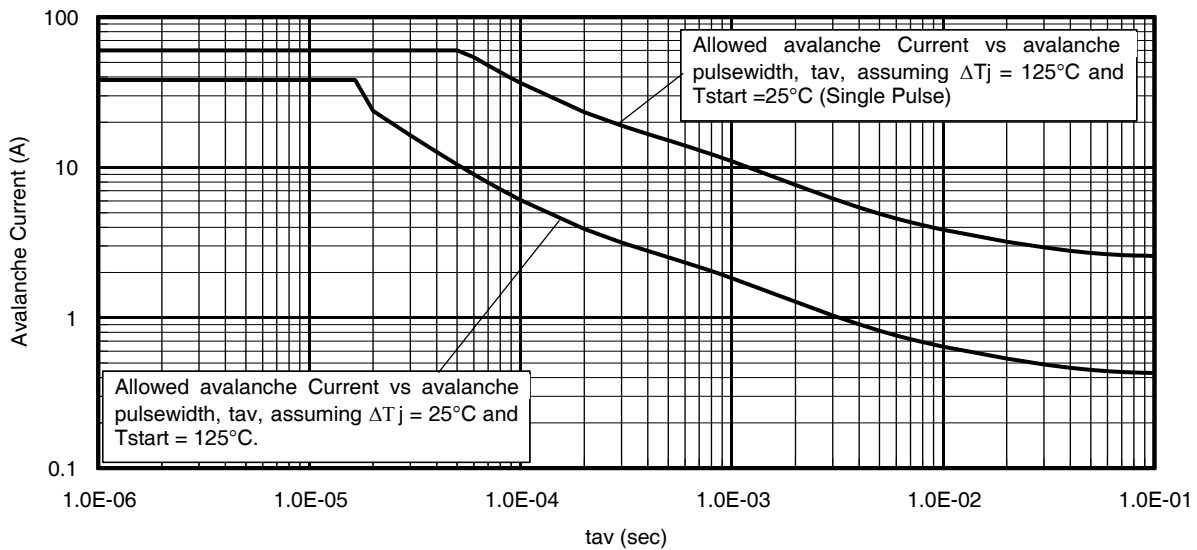
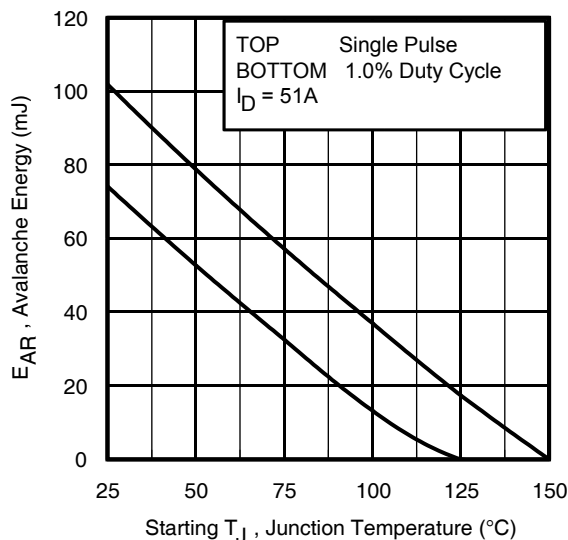
Fig 5. Typical Transfer Characteristics

Fig 6. Normalized On-Resistance vs. Temperature

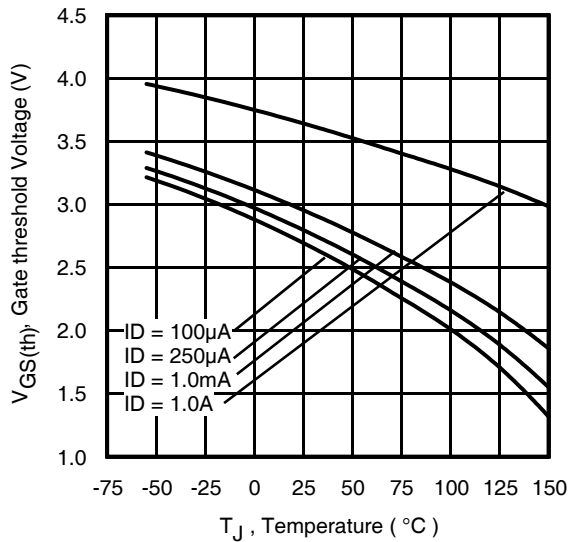
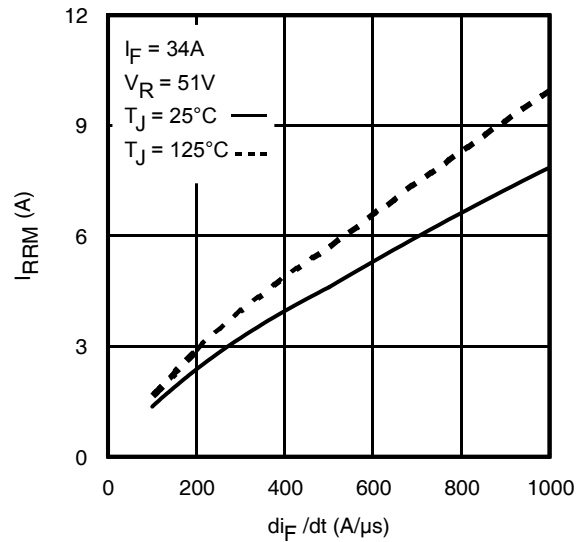
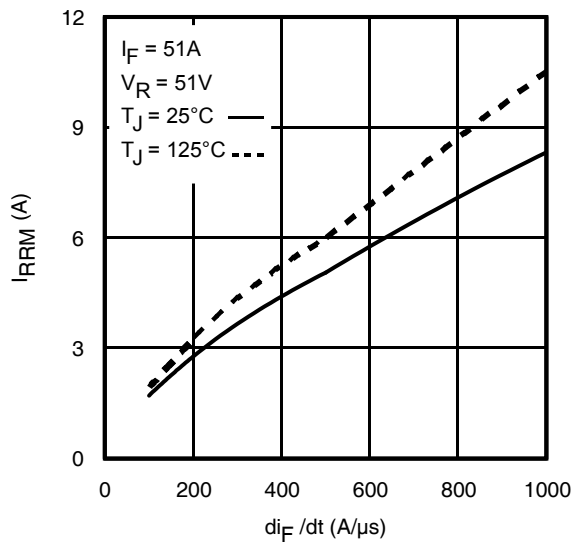
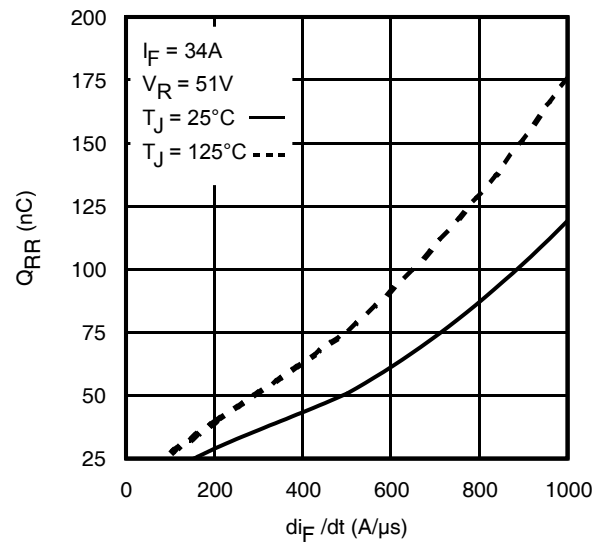
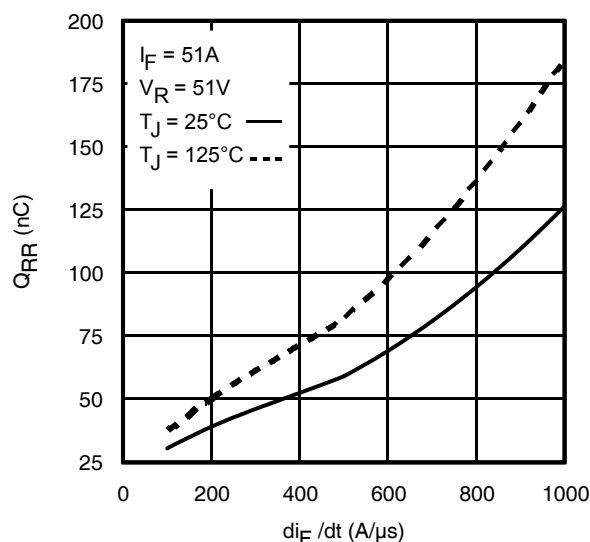
Fig 7. Typical Capacitance vs. Drain-to-Source Voltage

Fig 8. Typical Gate Charge vs. Gate-to-Source Voltage

Fig 9. Typical Source-Drain Diode Forward Voltage

Fig 10. Maximum Safe Operating Area

Fig 11. Drain-to-Source Breakdown Voltage

Fig 12. Typical C_{oss} Stored Energy

Fig 13. Typical On-Resistance vs. Drain Current

Fig 14. Maximum Effective Transient Thermal Impedance, Junction-to-Case

Fig 15. Avalanche Current vs. Pulse Width

Fig 16. Maximum Avalanche Energy vs. Temperature
**Notes on Repetitive Avalanche Curves , Figures 15, 16:
(For further info, see AN-1005 at www.irf.com)**

1. Avalanche failures assumption:
Purely a thermal phenomenon and failure occurs at a temperature far in excess of T_{jmax} . This is validated for every part type.
2. Safe operation in Avalanche is allowed as long as T_{jmax} is not exceeded.
3. Equation below based on circuit and waveforms shown in Figures 23a, 23b.
4. $P_{D(ave)}$ = Average power dissipation per single avalanche pulse.
5. BV = Rated breakdown voltage (1.3 factor accounts for voltage increase during avalanche).
6. I_{av} = Allowable avalanche current.
7. ΔT = Allowable rise in junction temperature, not to exceed T_{jmax} (assumed as 25°C in Figure 15, 16).
 t_{av} = Average time in avalanche.
 D = Duty cycle in avalanche = $t_{av} \cdot f$
 $Z_{thjC}(D, t_{av})$ = Transient thermal resistance, see Figures 13)
 $P_{D(ave)} = 1/2 (1.3 \cdot BV \cdot I_{av}) = \Delta T / Z_{thjC}$
 $I_{av} = 2\Delta T / [1.3 \cdot BV \cdot Z_{thjC}]$
 $E_{AS(AR)} = P_{D(ave)} \cdot t_{av}$

Fig 17. Threshold Voltage vs. Temperature

Fig 18. Typical Recovery Current vs. di_F/dt

Fig 19. Typical Recovery Current vs. di_F/dt

Fig 20. Typical Stored Charge vs. di_F/dt

Fig 21. Typical Stored Charge vs. di_F/dt

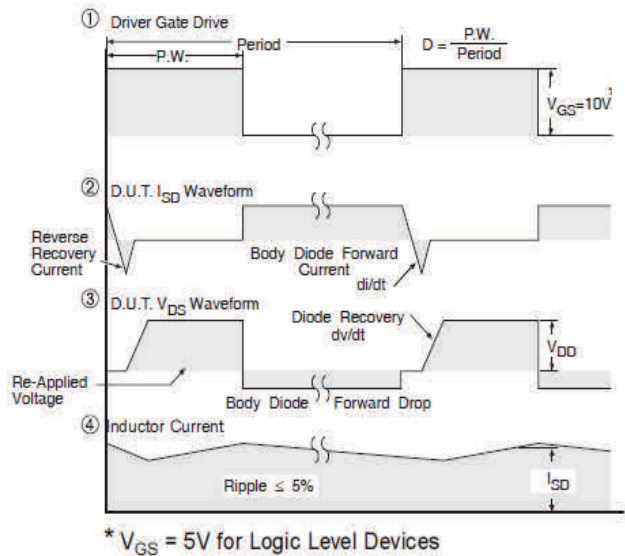
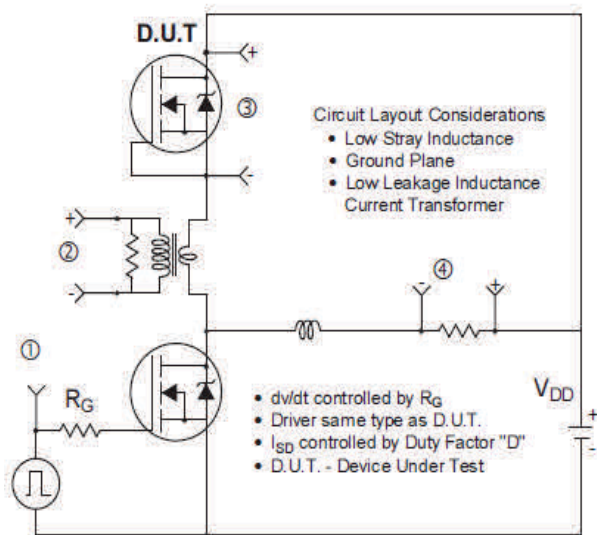
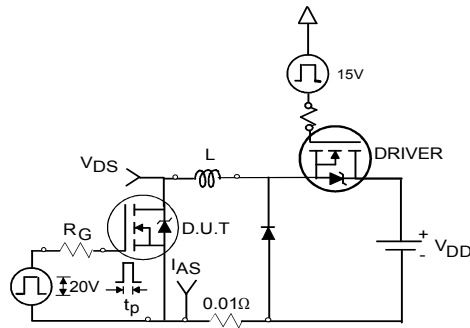
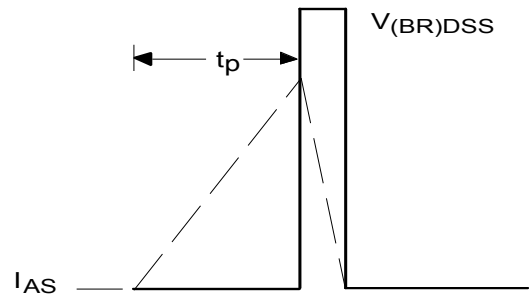
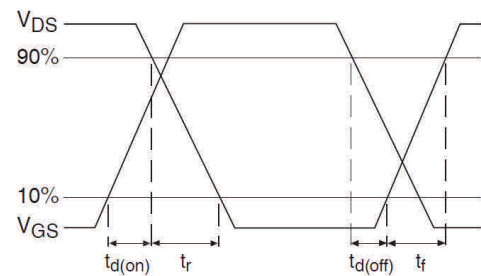
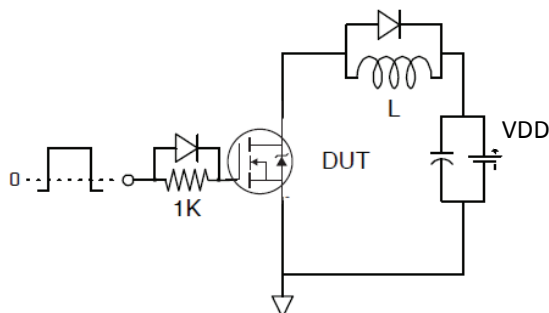
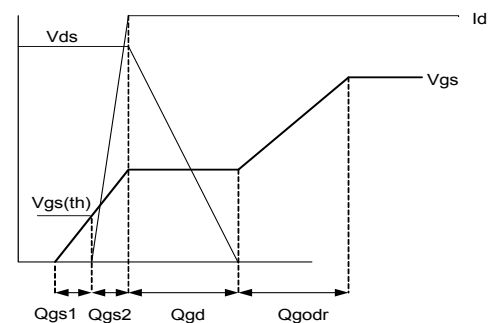
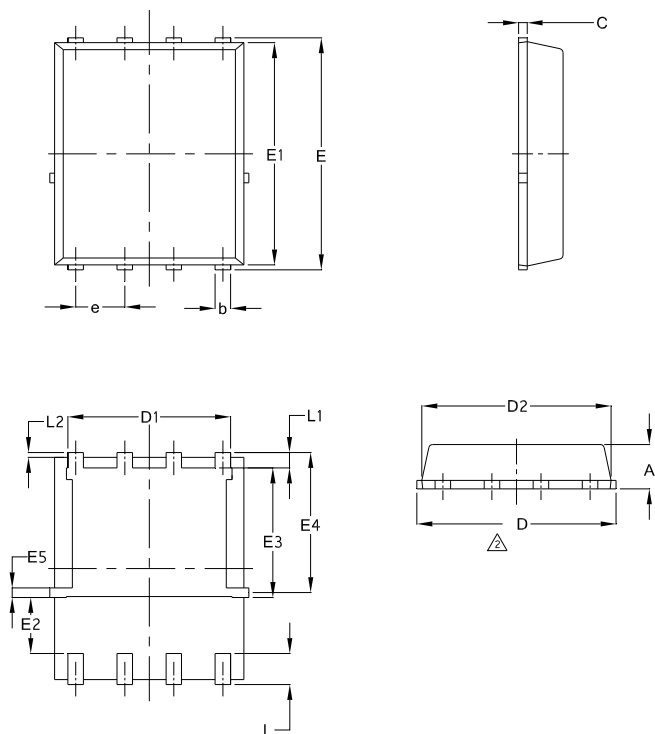

Fig 22. Peak Diode Recovery dv/dt Test Circuit for N-Channel HEXFET® Power MOSFETs

Fig 23a. Unclamped Inductive Test Circuit

Fig 23b. Unclamped Inductive Waveforms

Fig 24a. Switching Time Test Circuit

Fig 24b. Switching Time Waveforms

Fig 25a. Gate Charge Test Circuit

Fig 25b. Gate Charge Waveform

PQFN 5x6 Outline "E" Package Details

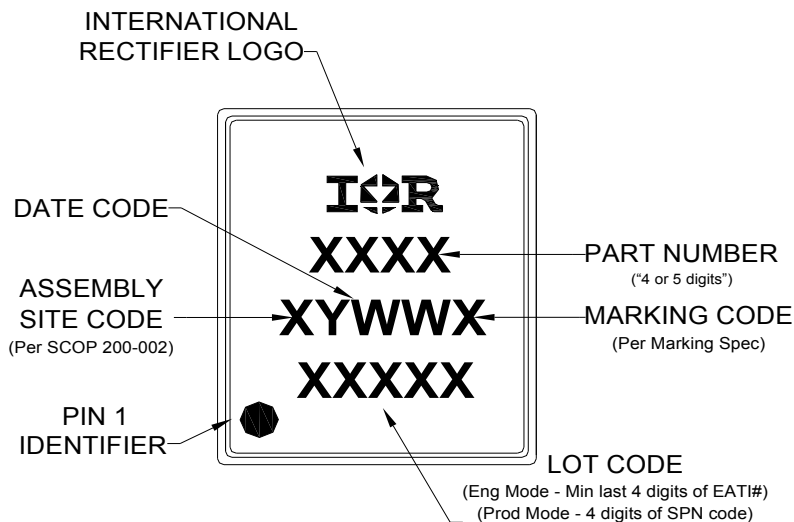
SYMBOL	COMMON			
	MM		INCH	
	MIN.	MAX.	MIN.	MAX.
A	0.90	1.17	0.0354	0.0461
b	0.31	0.51	0.0130	0.0189
C	0.195	0.300	0.0077	0.0118
D	4.80	5.25	0.1890	0.2028
D1	3.91	4.31	0.1539	0.1697
D2	4.80	5.10	0.1890	0.1968
E	5.90	6.25	0.2323	0.2421
E1	5.65	6.15	0.2224	0.2362
E2	1.10	—	0.0594	—
E3	3.32	3.78	0.1307	0.1480
E4	3.52	3.72	0.1346	0.1409
E5	0.13	0.32	0.0071	0.0126
e	1.27	BSC	0.050	BSC
L	0.51	0.86	0.0020	0.0098
L1	0.38	0.71	0.0150	0.0260
L2	0.05	0.25	0.0201	0.0339
l	0	0.18	0	0.0071

For more information on board mounting, including footprint and stencil recommendation, please refer to application note AN-1136: <http://www.irf.com/technical-info/appnotes/an-1136.pdf>

For more information on package inspection techniques, please refer to application note AN-1154: <http://www.irf.com/technical-info/appnotes/an-1154.pdf>

PQFN 5x6 Outline "E" Part Marking

Note: For the most current drawing please refer to IR website at <http://www.irf.com/package/>

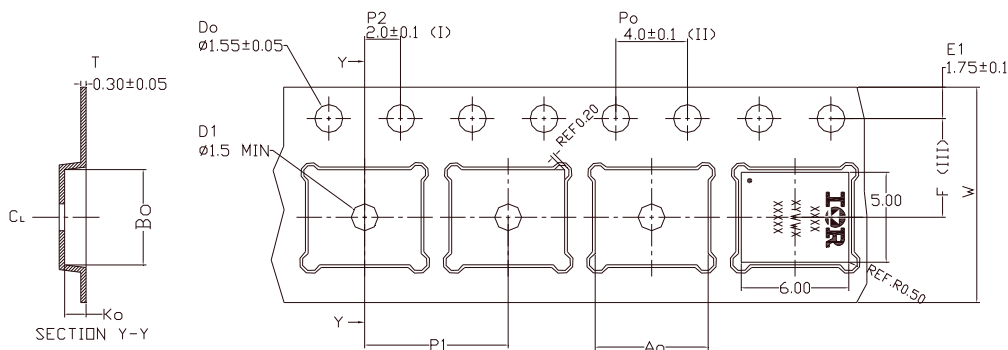
PQFN Tape and Reel

Ao	6.30 +/- 0.1
Bo	5.30 +/- 0.1
Ko	1.20 +/- 0.1
F	5.50 +/- 0.1
P1	8.00 +/- 0.1
W	12.00 +/- 0.3

- (I) Measured from centerline of sprocket hole to centerline of pocket.
- (II) Cumulative tolerance of 10 sprocket hole is ±0.20.
- (III) Measured from centerline of sprocket hole to centerline of pocket.
- (IV) Other material available.
- (V) Typical SR of form tape Max 10⁹ DHM/SQ.

ALL DIMENSIONS IN MILLIMETERS UNLESS OTHERWISE STATED.

Note: For the most current drawing please refer to IR website at <http://www.irf.com/package/>

Qualification Information[†]

Qualification Level	Industrial (per JEDEC JESD47F ^{††} guidelines)	
Moisture Sensitivity Level	PQFN 5mm x 6mm	MSL1 (per JEDEC J-STD-020D ^{††})
RoHS Compliant	Yes	

† Qualification standards can be found at International Rectifier's web site: <http://www.irf.com/product-info/reliability>

†† Applicable version of JEDEC standard at the time of product release.

Revision History

Date	Comments
8/21/2014	• Updated data sheet with latest PQFN Tape and Reel on page 10.
11/7/2014	• Updated E _{AS} (L = 1mH) = 160mJ on page 2 • Updated note 8 "Limited by T _{Jmax} , starting T _J = 25°C, L = 1mH, R _G = 50Ω, I _{AS} = 18A, V _{GS} = 10V" on page 2

IMPORTANT NOTICE

The information given in this document shall in no event be regarded as a guarantee of conditions or characteristics ("Beschaffheitsgarantie").

With respect to any examples, hints or any typical values stated herein and/or any information regarding the application of the product, Infineon Technologies hereby disclaims any and all warranties and liabilities of any kind, including without limitation warranties of non-infringement of intellectual property rights of any third party.

In addition, any information given in this document is subject to customer's compliance with its obligations stated in this document and any applicable legal requirements, norms and standards concerning customer's products and any use of the product of Infineon Technologies in customer's applications.

The data contained in this document is exclusively intended for technically trained staff. It is the responsibility of customer's technical departments to evaluate the suitability of the product for the intended application and the completeness of the product information given in this document with respect to such application.

For further information on the product, technology, delivery terms and conditions and prices please contact your nearest Infineon Technologies office (www.infineon.com).

WARNINGS

Due to technical requirements products may contain dangerous substances. For information on the types in question please contact your nearest Infineon Technologies office.

Except as otherwise explicitly approved by Infineon Technologies in a written document signed by authorized representatives of Infineon Technologies, Infineon Technologies' products may not be used in any applications where a failure of the product or any consequences of the use thereof can reasonably be expected to result in personal injury.