

TPS61310EVM-638 Evaluation Module User Guide

This user's guide describes the characteristics, functions, and use of the TPS61310EVM-638 Evaluation Module (EVM). This EVM demonstrates the Texas Instruments TPS61310 LED camera flash and video light driver with I²C interface. This document includes setup instructions, a schematic diagram, a bill of materials and PCB layout drawings for the EVM.

1 INTRODUCTION

The TPS61310 is an integrated system with a broad feature set for driving up to three LEDs for still-camera flash and video-camera lighting applications. The power stage is capable of supplying a maximum total current of up to 1600mA (2x400mA for LED1 and LED3, 800mA for LED2).

The device operates as an single, dual or triple channel LED driver generating the required LED forward voltages. The internal step-up converter boosts the input voltage adjusted to the required LED forward voltage and controls the LED current with the integrated current sinks.

The internal step-up converter can be used for further applications as well, such as supplying an audio amplifier.

All functions and feature sets can be either addressed by dedicated hardware pins or with the I²C interface.

1.1 Requirements

To operate this EVM, connect and properly configure the following components:

- Personal Computer:
 - OS: Windows™ 2000 or Windows™ XP
 - USB port
 - Minimum of 30MB of free hard disk space (100 MB recommended)
 - Minimum of 256MB of RAM
- Printed Circuit Board Assembly:
 - The board containing the TPS61310 in CSP-20 package.
 - External components
 - High power WLEDs
- USB-To-GPIO Adapter:
 - This USB interface adapter is used to evaluate the I²C controlled device via a personal computer using the USB interface. It receives the USB command, converts the signal into an I²C protocol and sends the I²C signal to the TPS61310EVM board. The USB-To-GPIO can be supplied at the following URL: ti.com
- Software:
 - Texas Instruments provides software to assist in evaluating this EVM. The software can either be installed from the supplied CD or download from the TI Web site

2 HARDWARE SETUP

This section describes the jumpers and connectors of the EVM and how to properly connect, set up and use the TPS61310EVM-638.

2.1 EVM Hardware Setup

Table 1. Board Input/Output Connector Descriptions

Jumper/Connector	Function
J1 – VIN/GND	J1 is for the IC positive input supply voltage and ground. The leads to the input supply should be twisted and kept as short as possible to minimize EMI transmission and reduce inductive voltage droop during a load-transient event. V_{IN} should be between 2.5V and 5.5V.
J2 – VOUT/GND	J2 is connected to the device output and GND pins. In flash or movie mode, V_{OUT} is connected to the LED anodes and can be used to access the high-side LED voltage. In voltage regulation mode, the header can be used to measure the regulated output voltage and connect an external load.
J3 – VOUT/LED1/LED2/TS/GND	These headers support external LEDs. The LED1 and LED2 headers link the LED cathodes to the device current sinks. The LED anodes are connected to the VOUT output. The TS header is provided for the NTC resistor (220k Ω) connection.
J4 – SCL/SDA/GND	J4 is connected to the device I ² C SCL and SDA. The serial clock and data line can be used to monitor the traffic between the PC and the EVM or set up I ² C communication.
J5 – I ² C Input for the USB-To-GPIO	J5 provides a link to the USB-To-GPIO 10-pin ribbon cable interface. The included software uses the adapter to communicate with the EVM via the I ² C protocol.
J6 – I ² C Input for the MSP430 USB-Debug-Interface	J6 is a 14-pin JTAG interface. It links the device to the MSP430 USB debug interface. The MSP430 embedded software uses the adapter to communicate with the EVM via the I ² C protocol.
JP1 – I ² C Pull-Up	This jumper is used to connect the SCL and SDA to two 2.2k Ω pull-up resistors. These resistors are either linked to the board input voltage or to ground. In normal use, the I ² C pull-up resistor should be connected to V_{in} . This configuration is due to the I ² C open-drain architecture.
JP2 – TS	JP2 is employed if the LED temperature is not monitored. In this case, the TS input should be tied to V_{in} .
JP3 – nReset	The nReset jumper is directly linked to the device hardware reset input. If this pin is LOW, the device is forced to shutdown mode, and the I ² C control and all internal control registers are reset. Otherwise, if nReset = HIGH, the device operates normally.
JP4 – Tx-Mask	JP4 is connected to the RF PA synchronization control input of the TPS61310. Tying this input HIGH switches the LED current from flash to video-light operation. In video-light mode, the peak current drained from the battery is significantly reduced.
JP5 – STRB1	JP5 selects the LED current to a high or low level. If the low current level is selected, the flash mode is enabled. In the other configuration, the video light mode is selected.
JP6 – STRB0	JP6 sets STRB0 to V_{in} or to GND. If STRB0 is HIGH, all the LED current regulators are activated.
JP7 – GPIO/PG/XINT	The middle pin of JP7 is connected to GPIO/PG on the TPS61310. The jumper is used to set GPIO to a high or a low level.
JP8 – Pull-up Resistor	JP8 allows connecting the GPIO/PG pull-up resistor to V_{in} . It is used to avoid setting a high level when the GPIO pin is not used.
JP9, 10 and 11 – Output current evaluation	These jumpers facilitate LED current measurements.

Table 2. Default Jumper Settings

JUMPER	DEFAULT
JP1	High
JP2	Unconnected
JP3	High
JP4	Low
JP5	Low
JP6	High
JP7	Unconnected
JP8	Unconnected
JP9	Connected

Table 2. Default Jumper Settings (continued)

JUMPER	DEFAULT
JP10	Connected
JP11	Connected

2.2 I²C Interface Setup

2.2.1 External Connections

Once the jumpers are set, connect the USB-To-GPIO adapter to the PC as shown in the drawing below.

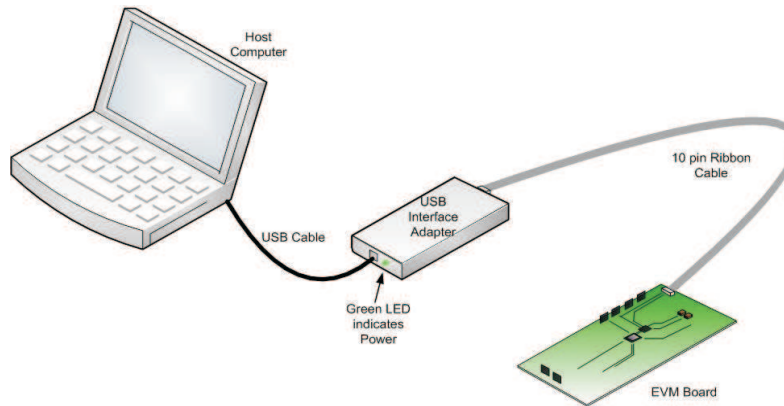

Figure 1. USB Interface Adapter Connection

Connect a positive input voltage between 2.5V and 5.5V with a minimum current capability of 1.3A.

WARNING

This EVM has white LEDs that flash with a very intense light. Eye protection and/or a diffuser to cover the LEDs during operation are recommended.

2.3 Software Setup

Either installed from the CD or downloaded from TI website, run Setup.exe and follow all the prompts to install the software. After installation, the software should automatically run.

3 EVM SOFTWARE SETUP AND OPERATION

3.1 General considerations

The EVM software running on a PC host, communicates with the device and provides access to its internal registers. First, the host checks if the USB-To-GPIO firmware version is up to date. If it is not, please download and update to the latest version. Note that after updating the firmware, the USB must be disconnected and reconnected. The same process applies to the EVM software.

3.2 Software Description

For ease of use, two user interfaces have been implemented: a simple one and a detailed one. The Setup menu permits switching from one to the other. In both interfaces, special care is taken to warn the user in case of hardware power or connection problems via indicators at the bottom of the window.

3.2.1 Simple Interface

The simple interface shown below appears by default when running the software.

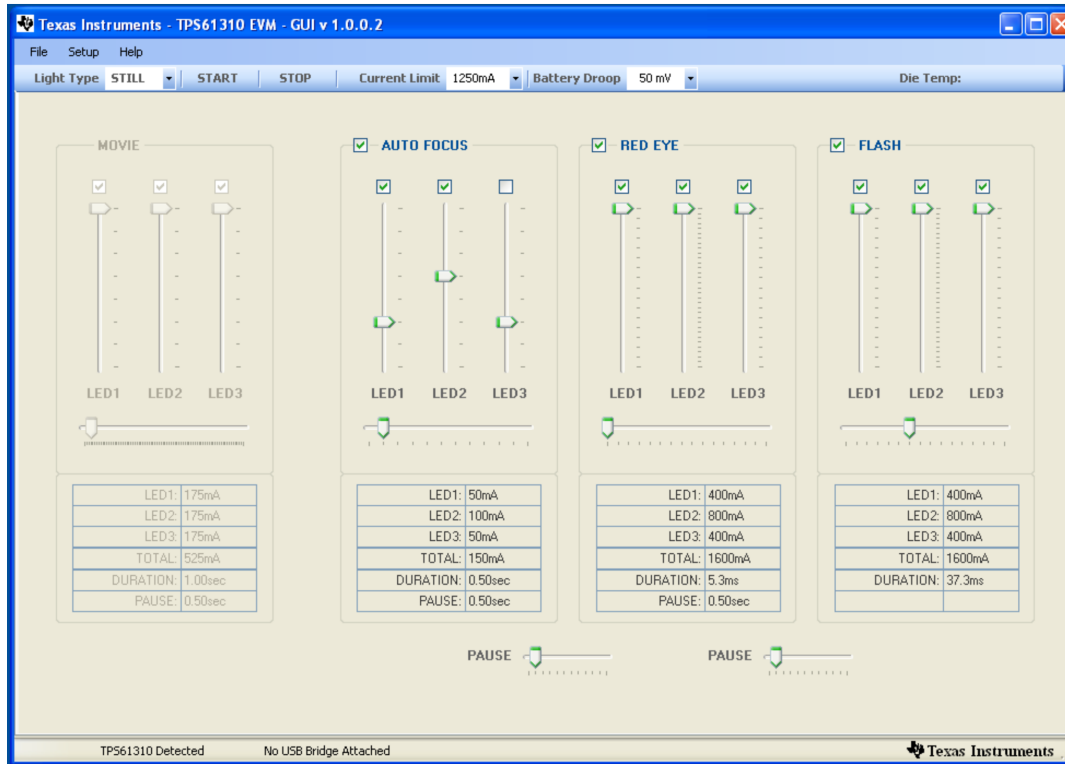

Figure 2. Simple Interface

Before starting any action, the current limit must be set after powering up the device. Once this is done, the user can choose two types of light applications. The movie type illustrates a typical DC continuous-light application such as video lighting. The still type shows a typical camera-flash application.

In both cases, the various LED parameters are easily modified by using the sliders. The battery droop is also selectable among several values.

To run and stop the chosen configuration, a START and a STOP button are provided.

3.2.2 Detailed Interface

The second interface puts forward all the TPS61310 features through the modeling of internal registers. Figure 3 illustrates the detailed interface of the evaluation software.

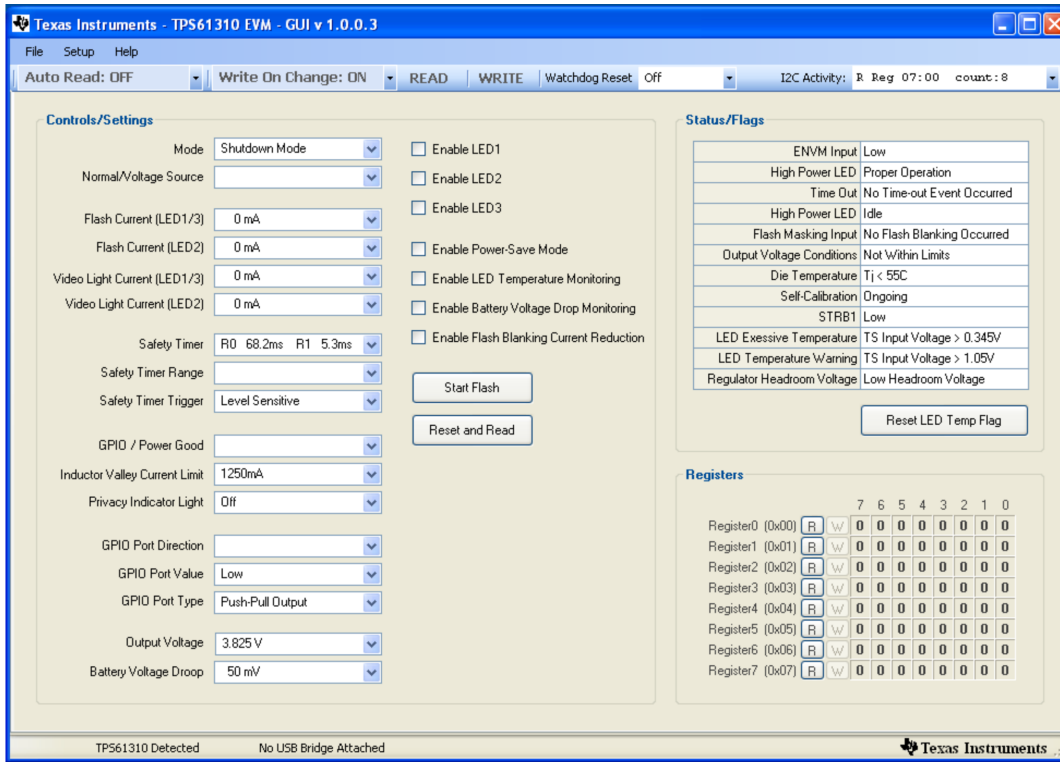

Figure 3. Detailed Interface

The toolbar allows control of parameters which are only accessible through the software. In addition to normal register Read and Write, the software has an Auto-read and a Write-On-Change function. The I²C activity box shows the action (Read or Write), the register address and data, and the number of transfers between the host and the device. The Watchdog Reset list-box is a DC light dedicated function which is aimed at refreshing the video mode of the IC.

This interface performs no calculations or computations; it simply reads and writes to and from the IC registers through the I²C interface.

As explained before, prior to use any features of the device, the ILIM bit must be set. Each register bits can be changed manually by clicking on the buttons corresponding to each bit in the panel, or can be changed through the drop-down boxes, check-boxes and buttons. Read-only bits are listed in the group-box Status/Flags.

The Reset and Read button writes REGISTER0[0]=1 and reads all the registers. Values shown in the table may differ from those presented in the datasheet as some bits assume two different functions in read and write operations.

4 TEST RESULTS

4.1 Flash mode

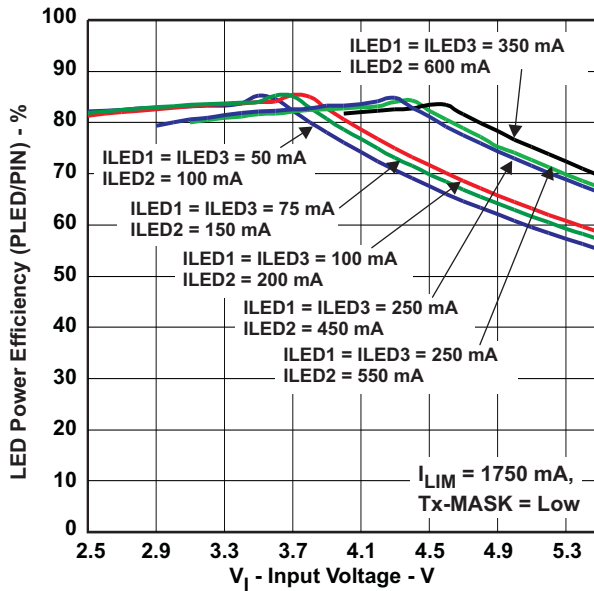

Figure 4. LED Power Efficiency vs Input Voltage

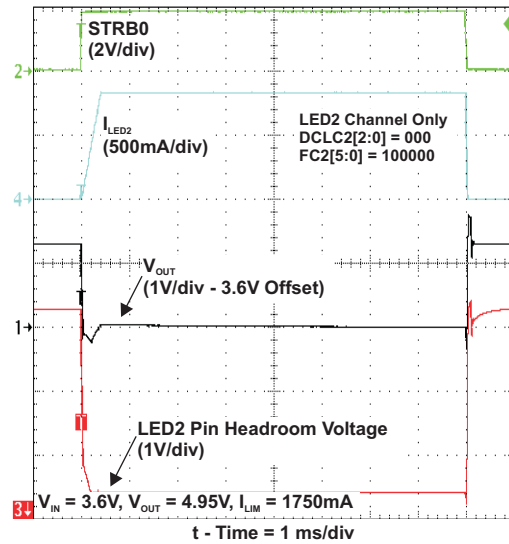

Figure 5. Flash Sequence

4.2 Video Light mode

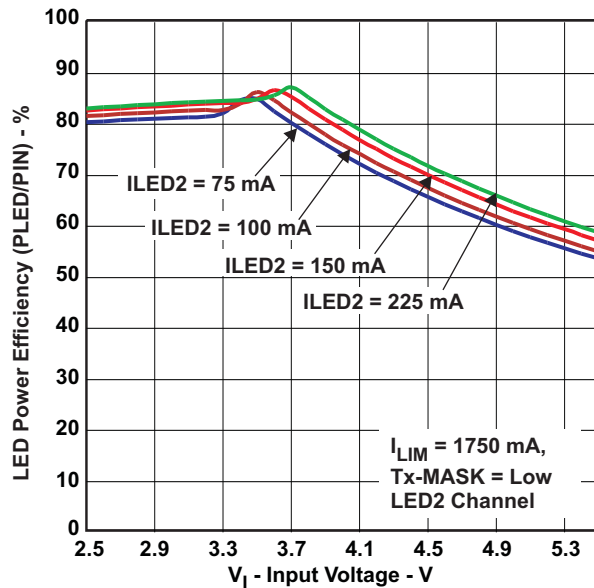

Figure 6. LED Power Efficiency vs Input Voltage

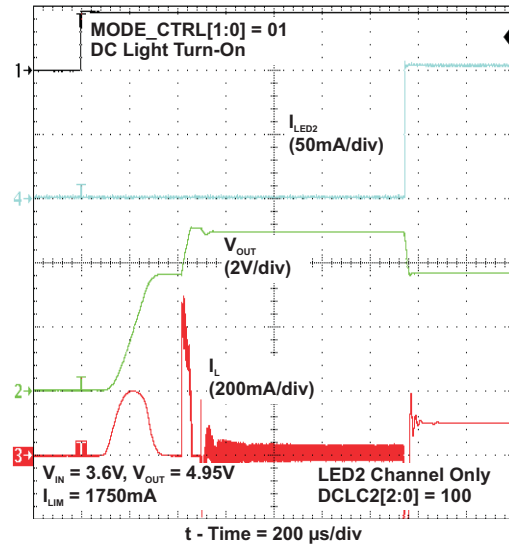

Figure 7. Video Light Startup

4.3 Voltage Mode

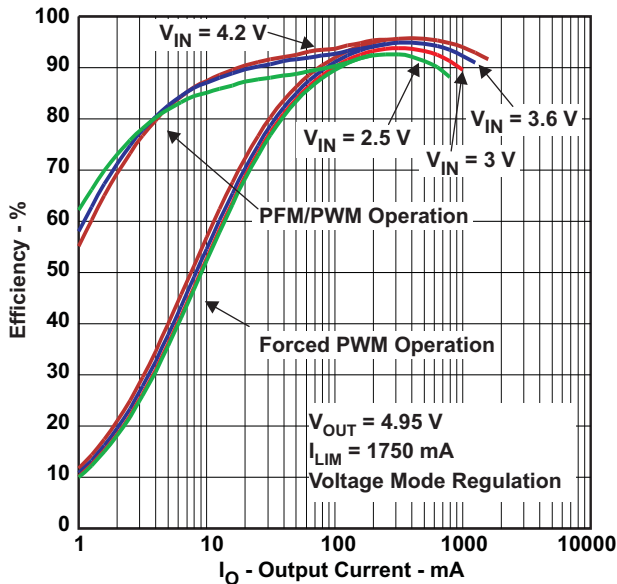

Figure 8. Efficiency vs Input Voltage

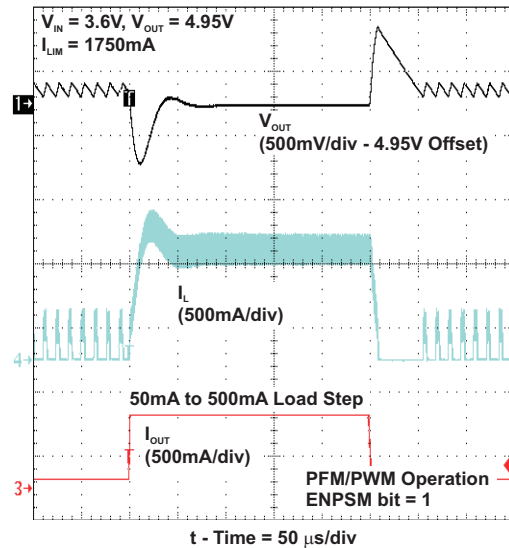

Figure 9. Load Transient

5 BOARD LAYOUT

Proper board layout is important for all high-frequency switch-mode power supplies. Figure 10 through Figure 14 show the board layout for the TPS61310EVM-638 PCB. The nodes with high switching frequencies and currents are kept as short as possible to minimize trace inductance. Careful attention has been given to the routing of high-frequency current loops. A single-point grounding scheme is used. Also, the majority of the heat sinking for this device occurs through the top layer traces and vias pulled from the IC's solder bumps that carry high currents. For specific layout guidelines, see the [TPS61310 data sheet](#).

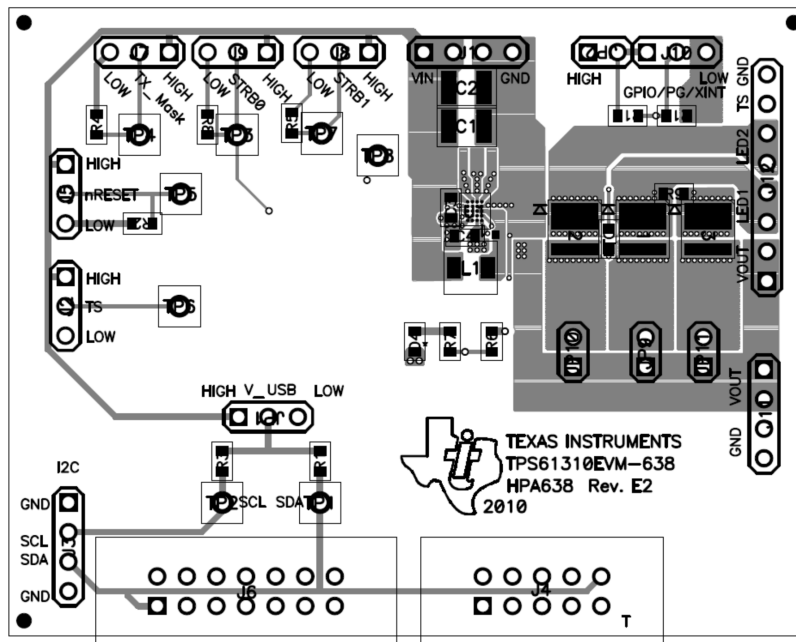

Figure 10. Assembly Layer

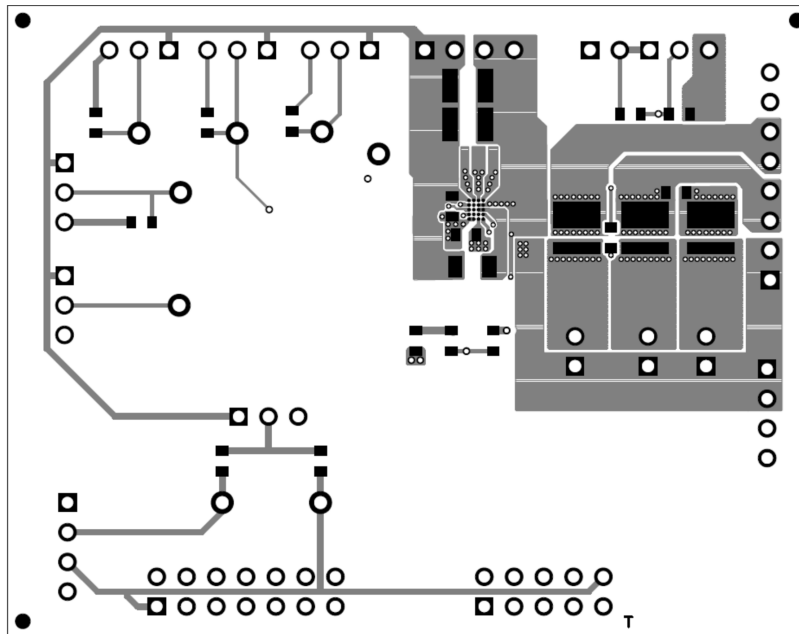

Figure 11. Top Layer

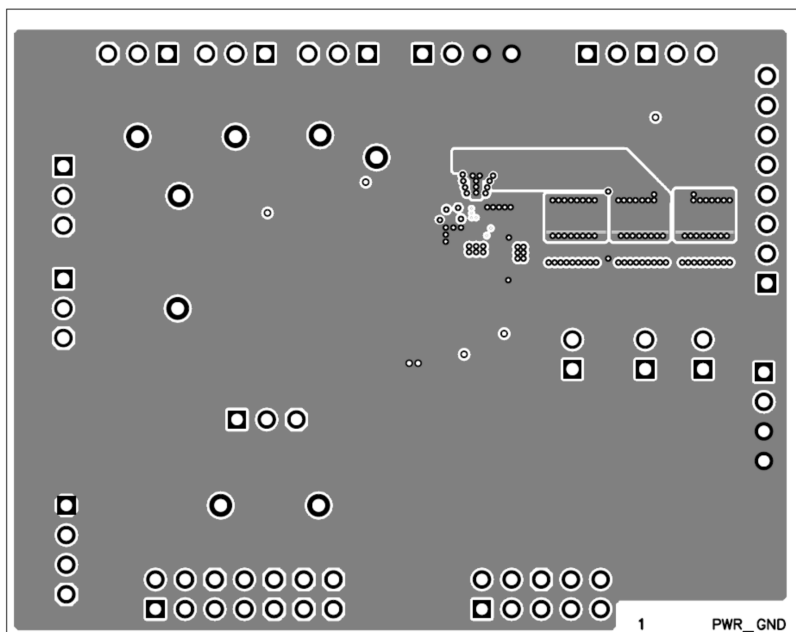

Figure 12. Layer 2

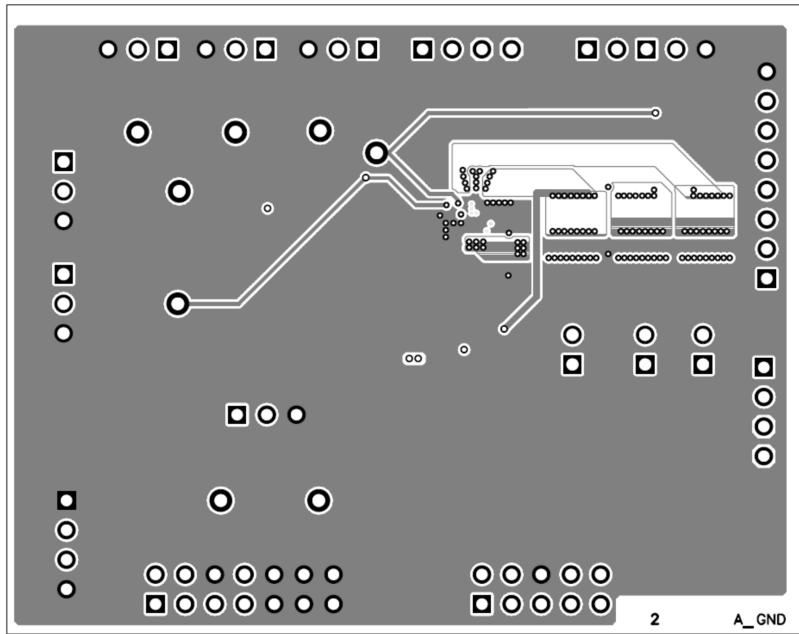

Figure 13. Layer 3

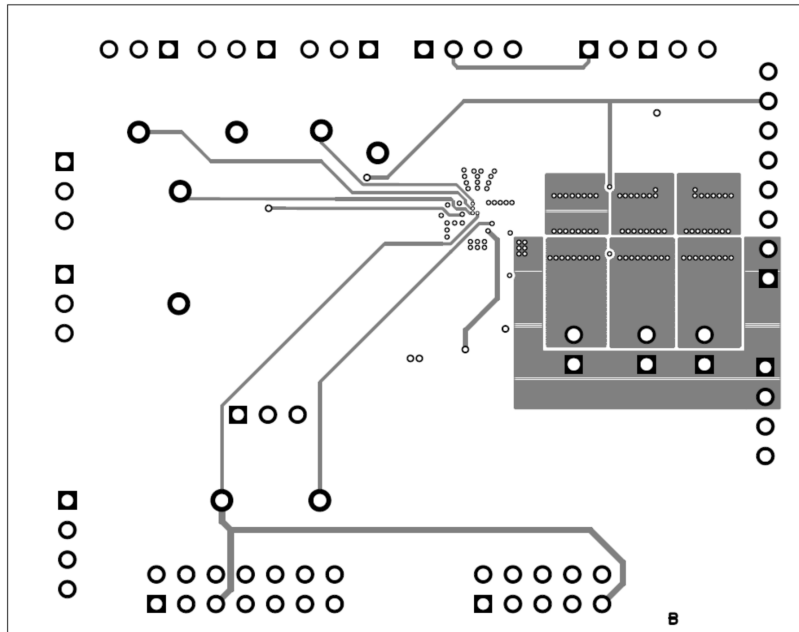

Figure 14. Bottom Layer

6 SCHEMATICS AND BILL OF MATERIALS

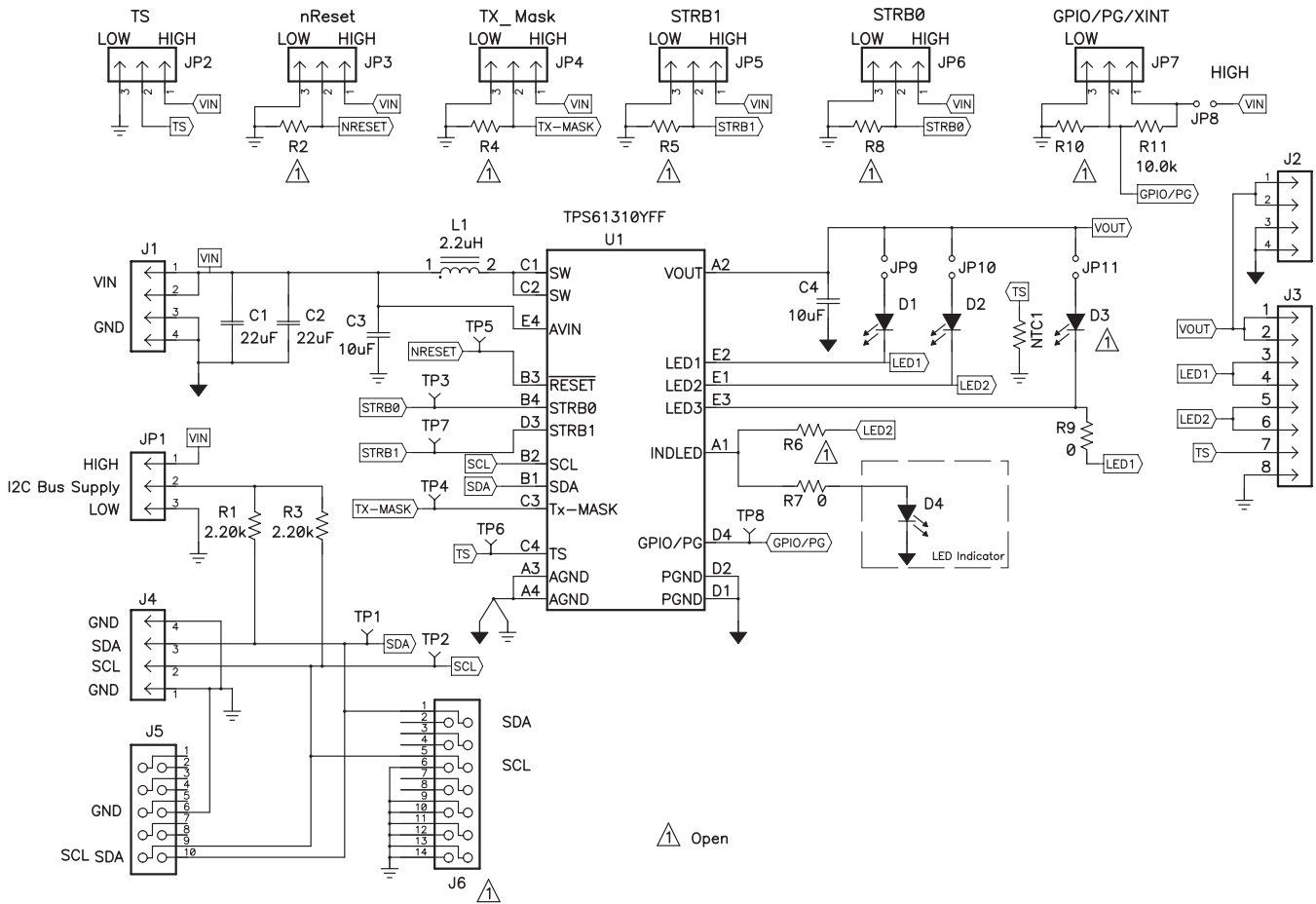

Figure 15. TPS61310EVM-638 Schematic

Table 3. TPS61310EVM-638 Bill of Materials

Qua.	Ref Des	Value	DI	Size	Part Number	Mfr
2	C1, C2	22µF	Capacitor, Ceramic, 16V, X5R	1210	C3225X7R1C226M	TDK
2	C3, C4	10µF	Capacitor, Ceramic, 10-µF, 6.3-V, X5R, 10%	0603	C1608X5R0J106MT	TDK
2	D1, D2	CERAMOS	Diode, Flash, 1amp, V _{fwd} 3.9V	.065*.080 inch	Ceramos LWW C9EP	OSRAM
0	D3	Open	Diode, Flash, 1amp, V _{fwd} 3.9V	.065*.080 inch	Ceramos LWW C9EP	OSRAM
1	D4	LS Q976	Diode, LED, [Color], 20mA	0603	LS Q976	Osram
3	J1, J3, J11	PEC04SAAN	Header, 4-pin, 100mil spacing	0.100 x 4	PEC04SAAN	Sullins
1	J12	PEC08SAAN	Header, Male 8-pin, 100mil spacing	0.100 inch x 8	PEC08SAAN	Sullins
6	J2, J5, J7, J8, J9, J10	PEC03SAAN	Header, Male 3-pin, 100mil spacing,	0.100 inch x 3	PEC03SAAN	Sullins
1	J4	N2510-6002RB	Connector, Male Straight 2x10 pin, 100mil spacing, 4 Wall	0.338 x 0.788 inch	N2510-6002RB	3M
1	J6	N2514-6002RB	Connector, Male Straight 2x7 pin, 100mil spacing, 4 Wall	0.100 inch x 2X7	N2514-6002RB	3M
1	JP1	PEC03SAAN	Header, 3-pin, 100mil spacing	0.100 x 3	PEC03SAAN	Sullins
1	JP2	PEC02SAAN	Header, 2-pin, 100mil spacing	0.100 inch x 2	PEC02SAAN	Sullins

Table 3. TPS61310EVM-638 Bill of Materials (continued)

1	L1	2.2uH	Inductor, SMT	0.130 X 0.130 inch	FDSE0312- 2R2M-P3	Toko
1	NTC1	NCP18WM224 J03RB	Resistor, Chip, 1/16W, 5%	0603	CRCW0603- xxx-J	Vishay
2	R1, R3	2.20kΩ	Resistor, Chip, 1/16W, 1%	0603	Std	Std
1	R11	10.0kΩ	Resistor, Chip, 1/16W, 1%	0603	Std	Std
0	R2, R4, R5, R6, R8, R10	Open	Resistor, Chip, 1/16W, 1%	0603	Std	Std
2	R7, R9	0	Resistor, Chip, 1/16W, 1%	0603	Std	Std
8	TP1, TP2, TP3, TP4, TP5, TP6, TP7, TP8	5000	Test Point, Red, Thru Hole Color Keyed	0.100 x 0.100 inch	5000	Keystone
1	U1	TPS61310YFF	IC, High Power Multiple White LED Drive w/ I ² C Compatible Interface	DSBGA	TPS61310YFF	TI
8	–		Shunt, 100-mil, Black	0.100	929950-00	3M

IMPORTANT NOTICE

Texas Instruments Incorporated and its subsidiaries (TI) reserve the right to make corrections, modifications, enhancements, improvements, and other changes to its products and services at any time and to discontinue any product or service without notice. Customers should obtain the latest relevant information before placing orders and should verify that such information is current and complete. All products are sold subject to TI's terms and conditions of sale supplied at the time of order acknowledgment.

TI warrants performance of its hardware products to the specifications applicable at the time of sale in accordance with TI's standard warranty. Testing and other quality control techniques are used to the extent TI deems necessary to support this warranty. Except where mandated by government requirements, testing of all parameters of each product is not necessarily performed.

TI assumes no liability for applications assistance or customer product design. Customers are responsible for their products and applications using TI components. To minimize the risks associated with customer products and applications, customers should provide adequate design and operating safeguards.

TI does not warrant or represent that any license, either express or implied, is granted under any TI patent right, copyright, mask work right, or other TI intellectual property right relating to any combination, machine, or process in which TI products or services are used. Information published by TI regarding third-party products or services does not constitute a license from TI to use such products or services or a warranty or endorsement thereof. Use of such information may require a license from a third party under the patents or other intellectual property of the third party, or a license from TI under the patents or other intellectual property of TI.

Reproduction of TI information in TI data books or data sheets is permissible only if reproduction is without alteration and is accompanied by all associated warranties, conditions, limitations, and notices. Reproduction of this information with alteration is an unfair and deceptive business practice. TI is not responsible or liable for such altered documentation. Information of third parties may be subject to additional restrictions.

Resale of TI products or services with statements different from or beyond the parameters stated by TI for that product or service voids all express and any implied warranties for the associated TI product or service and is an unfair and deceptive business practice. TI is not responsible or liable for any such statements.

TI products are not authorized for use in safety-critical applications (such as life support) where a failure of the TI product would reasonably be expected to cause severe personal injury or death, unless officers of the parties have executed an agreement specifically governing such use. Buyers represent that they have all necessary expertise in the safety and regulatory ramifications of their applications, and acknowledge and agree that they are solely responsible for all legal, regulatory and safety-related requirements concerning their products and any use of TI products in such safety-critical applications, notwithstanding any applications-related information or support that may be provided by TI. Further, Buyers must fully indemnify TI and its representatives against any damages arising out of the use of TI products in such safety-critical applications.

TI products are neither designed nor intended for use in military/aerospace applications or environments unless the TI products are specifically designated by TI as military-grade or "enhanced plastic." Only products designated by TI as military-grade meet military specifications. Buyers acknowledge and agree that any such use of TI products which TI has not designated as military-grade is solely at the Buyer's risk, and that they are solely responsible for compliance with all legal and regulatory requirements in connection with such use.

TI products are neither designed nor intended for use in automotive applications or environments unless the specific TI products are designated by TI as compliant with ISO/TS 16949 requirements. Buyers acknowledge and agree that, if they use any non-designated products in automotive applications, TI will not be responsible for any failure to meet such requirements.

Following are URLs where you can obtain information on other Texas Instruments products and application solutions:

Products

Audio	www.ti.com/audio
Amplifiers	amplifier.ti.com
Data Converters	dataconverter.ti.com
DLP® Products	www.dlp.com
DSP	dsp.ti.com
Clocks and Timers	www.ti.com/clocks
Interface	interface.ti.com
Logic	logic.ti.com
Power Mgmt	power.ti.com
Microcontrollers	microcontroller.ti.com
RFID	www.ti-rfid.com
RF/IF and ZigBee® Solutions	www.ti.com/lprf

Applications

Communications and Telecom	www.ti.com/communications
Computers and Peripherals	www.ti.com/computers
Consumer Electronics	www.ti.com/consumer-apps
Energy and Lighting	www.ti.com/energy
Industrial	www.ti.com/industrial
Medical	www.ti.com/medical
Security	www.ti.com/security
Space, Avionics and Defense	www.ti.com/space-avionics-defense
Transportation and Automotive	www.ti.com/automotive
Video and Imaging	www.ti.com/video
Wireless	www.ti.com/wireless-apps

TI E2E Community Home Page

e2e.ti.com

Mailing Address: Texas Instruments, Post Office Box 655303, Dallas, Texas 75265
Copyright © 2011, Texas Instruments Incorporated