



SENSING AND CONTROL

Thermal Management Solutions



HONEYWELL. TURNING CHALLENGES INTO SOLUTIONS.

The Honeywell name stands for dependability, a critical trait for products used in medical applications. Yet with Honeywell, quality products are just the beginning. You can count on an experienced technical support team. Even more, because nearly all Honeywell thermal solutions can be customized, you can be assured the device will immediately satisfy the needs of your application.



WHAT'S INSIDE

- 04 Quality Manufacturing
- 05 Customized to your Specifications
- 05 Flexible Heater Assembly Engineering Kit
- 06 Technical Support
- 07 Response to RFQs and Samples
- 08 Anesthesia Machines/Ventilators
- 12 Sleep Apnea Machines
- 14 Dialysis Machines
- 16 Infusion Pumps
- 18 Infant and Laboratory Incubators
- 20 Diagnostic Equipment
- 22 Autoclaves

A WIDE RANGE OF THERMAL MANAGEMENT SOLUTIONS FOR A WIDE RANGE OF MEDICAL APPLICATIONS

	Anesthesia Machines/ Ventilators	Sleep Apnea Machines	Dialysis Machines	Infusion Pumps	Infant and Laboratory Incubators	Diagnostic Equipment	Autoclaves
Humidity Sensors							
HIH6130/6131 Series	•	•			•		
HIH-4000 Series	•	•			•		
HIH-4020/4021 Series	•	•			•		
HIH-4030/4031 Series	•	•			•		
HIH-5030/5031 Series	•	•			•		
HCH-1000 Series	•	•			•		
Flexible Heater Assemblies							
A3100 Series	•	•	•		•	•	•
A3200 Series	•	•	•		•	•	•
A3400 Series	•	•	•	•	•	•	•
C3100 Series	•	•	•		•	•	•
C3200 Series	•	•	•		•	•	•
C3400 Series	•	•	•	•	•	•	•
78000 Series (transparent)				•			
Pre-Packaged Temperature Probes							
500 Series	•	•	•				•
RTD Temperature Sensors							
HEL-775 Series					•		
NTC Thermistors							
192 Series	•	•	•		•	•	
194 Series	•	•	•		•	•	
Thermostats							
2450RC Series		•			•		



BUILT TO WORK. BUILT TO LAST.

Honeywell's manufacturing excellence dates back more than a century and has been proven worldwide. But what really matters is how Honeywell can put that recognized quality to work for you.

First, Honeywell designs and manufactures many of its own products, so the quality can be monitored and maintained throughout the process. In addition, Honeywell's dedicated thermal device engineering team obtains detailed Voice of Customer feedback so that the products Honeywell designs and manufactures are reliable, accurate and easy to install into today's medical devices.





CUSTOMIZED FOR YOUR MEDICAL SPECIFICATIONS

Honeywell offers a vast range of thermal products for medical applications that are immediately available. But unlike other suppliers, that's just the beginning. Honeywell's thermal product line can be customized to meet your exact needs. The days of settling for just what's available are over.



Flexible heater customized for a ventilator exhalation valve cover.

FLEXIBLE HEATER ASSEMBLY ENGINEERING KIT

Honeywell offers a flexible heater assembly engineering kit designed for equipment designers, manufacturing engineers, and technicians. The kit houses many flexible heater assemblies in various shapes and wattages that can be easily removed from the perforated sheet, so you can experiment with the product to help decide what your customized heater solution needs to be. The kit is available in polyamide or silicone, and with or without pressure sensitive adhesive.

The Flexible Heater Assembly Engineering Kit can be ordered by contacting Honeywell's Customer Response Center at **+1 815-235-6847** or at **info.sc@honeywell.com**.

Catalog listings

- 22000-002a (includes pressure sensitive adhesive)
- 22000-001a (includes pressure sensitive adhesive)
- 22000-002
- 22000-001



TECHNICAL SUPPORT, DAY IN AND DAY OUT.

Honeywell's experienced application engineers are with you from the start. From up-front technical help to ongoing engineering expertise, they'll work with you throughout the product development process to create a customized solution for your application.

Honeywell offers the medical industry the smartest solutions and the savviest engineers ready to solve your problem with expert technical support — all on demand.





FAST RESPONSE TO RFQS AND SAMPLES

Responding quickly to your Request for Quotes (RFQs) and product sample needs is a hallmark of Honeywell. Our experienced engineers understand the importance of timely quotes. And because Honeywell is a manufacturer, you can depend on a quick response to your prototype needs.

- Dedicated teams and manufacturing processes ensure that even custom new products are quoted in one week or less, and product samples are shipped in as fast as five business days.
- Rapid prototyping equipment and manufacturing processes help ensure that product samples are delivered in time to support your demanding product development cycle.
- Experienced technical support is there every step of the way so that the product is quoted and sampled quickly.

RESPONSE TIME

Once we receive your request, you can expect the following response time:

RFQ Responses

- Custom thermal products typically within one week or less

Sample Delivery

- **Humidity Sensors** — Typically ship immediately from stock
- **Flexible Heaters** — Typically ship within 5 business days of material availability
- **NTC Thermistors** — Typically either ship immediately from stock or are built to order, depending on the product ordered
- **Thermostats and Temperature Probes** — Typically ship within 17 - 20 working days



ANESTHESIA MACHINES/ VENTILATORS

BREATHE EASIER WITH HONEYWELL

Manufacturers of anesthesia machines can trust Honeywell thermal management solutions to effectively and accurately monitor and control the anesthesia delivered to the patient, helping to improve patient safety and comfort. Choose packaged sensors as components for your assemblies, or Honeywell can provide a fully assembled solution you can integrate into your system.

For ventilators, Honeywell's thermal components dry condensation to prevent pooling at the exhalation valve, helping to provide a comfortable breathing environment for the patient. In either case, Honeywell products can be customized to your specifications to meet your exact application needs.



192 Series



194 Series



NTC THERMISTORS

192 Series, 194 Series

Anesthesia machines that emit warm, moist air provides the patient with a comfortable breathing environment that helps reduce sore throats caused by breathing cold, dry air. Honeywell discrete thermistor temperature sensors are installed directly into the air stream to monitor the air temperature, and the sensor is coupled to a microcontroller designed to measure air stream temperature and interact with the controller that regulates the temperature of the air stream.

Ventilators that use warm, moist air to provide the patient with a comfortable breathing situation need the temperature of that air to be monitored and controlled. Honeywell discrete thermistor temperature sensors are installed directly into the air stream to monitor the air temperature, and the sensor is coupled to a microcontroller designed to measure air stream temperature and interact with the controller that regulates the temperature of the air stream.

- **Accurate Performance** — Designed for enhanced accuracy and stability.
- **Cost Effective** — With Honeywell thermistors, the resistance temperature curve interchangeability offers standardization of circuit components and simplification of design and replacement.
- **Flexible** — Bare leads (192 Series) or insulated leads (194 Series) provide versatility within your application.
- **Small** — The compact size of Honeywell thermistors makes them easy to use in confined spaces.



500 Series

PRE-PACKAGED TEMPERATURE PROBES

500 Series

Pre-packaged temperature probes perform the same function as thermistors (monitor air temperature).

- **Flexible** — Wide selection of housing, resistance, and termination options accommodate air/gas, fluid immersion or surface sensing requirements.
- **Customizable** — Variety of custom or off-the-shelf products available.



HIH6130/6131 Series HIH-4000 Series HIH-4020/4021 Series HIH-4030/4031 Series, HIH-5030/5031 Series HCH-1000 Series

HUMIDITY SENSORS

Honeywell HumidCon™ Digital Humidity/Temperature Sensor HIH6130/6131 Series, HIH-4000 Series, HIH-4020/4021 Series, HIH-4030/4031 Series, HIH-5030/5031 Series, HCH-1000 Series

Moisture introduced into the ventilator must be monitored and controlled. Honeywell's humidity sensors are installed either directly into the air stream or in a parallel branch. The sensor is coupled to a microcontroller designed to measure the humidity of the air stream and to signal the controller that the desired level of moisture is present.

Total Thermal Management Solutions for Ventilator Condensation Applications

If condensation pools at the ventilator's exhalation valve, the airflow measurement at this location may be skewed, resulting in the ventilator delivering an incorrect amount of air to the patient.

A Honeywell flexible heater can be customized to fit inside the ventilator exhalation valve cover, keeping the exhalation cover and valve warm to dry condensation before it can build up.

- **Improved Patient Care** — Accurate airflow measurement at the exhalation valve helps ensure that the correct airflow is being delivered to the patient.
- **Removable Exhalation Valve Cover** — Allows the exhalation valve to be sterilized and reused.



Customized to your Specifications

Honeywell will manufacture many thermal components to the ideal requirements needed for your machine.

- **Industry-Leading Stability** — Honeywell HumidCon™ Sensors' stability of 1.2 %RH over 5 years eliminates your need to recalibrate the sensor in the application, minimizing system performance issues and supporting system uptime.
- **Lowest Total Cost Solution** — By combining a humidity and temperature sensor in the same package, Honeywell HumidCon™ Sensors eliminate the need for separate sensors in certain applications, while industry-leading Total Error Band Accuracy of ± 5 %RH eliminates individual sensor testing and calibration, supports system accuracy and warranty requirements, optimizes system uptime, and provides excellent sensor interchangeability.
- **Energy Efficient** — Honeywell HumidCon™ Sensors' low 2.3 Vdc supply voltage allows for use in low energy and wireless-compatible applications. Plus, the sleep mode feature reduces power consumption to maximize battery life and reduce both the power supply size and the application's overall weight.
- **Small** — The compact design lets you reduce the overall size of your PC board and gives you options for use within the application.
- **Enhanced Accuracy** — Enhanced stability, accuracy and response time over the entire 0-100 %RH range supports demanding system performance requirements, even in many condensing environments.
- **Cost Effective** — With surface mount device (SMD) packaging on tape and reel, you can use Honeywell humidity sensors in automated, high-volume, lower-cost pick-and-place manufacturing.
- **Durable** — The multi-layer construction and a hydrophobic filter provide enhanced resistance to condensation and contaminants.



3100 Series



3200 Series



3400 Series



FLEXIBLE HEATER ASSEMBLIES

A3100 Series, A3200 Series, A3400 Series, C3100 Series, C3200 Series, C3400 Series

In ventilators, a flexible heater is often required to warm water to vapor to provide the comfortable breathing environment most preferred by patients. The heat is generally controlled by an onboard negative temperature coefficient (NTC) thermistor offering variable air temperature that can be used to adjust the vapor/air temperature to improve patient comfort.

- **Total Thermal Management Solution** — Value-added heater assemblies include mounting, temperature monitoring and control capabilities. Honeywell can design and manufacture complete heater turnkey assemblies, including supplying a vulcanized or adhered heater assembly to a heat plate, heat sink, mounting bracket or cover.
- **Uniform Heating** — Count on even heat distribution (no hot spots) across the heater surface.
- **Improves Patient Comfort** — Integration of mounting and sensing components allow for the desired vaporization of water, enhancing patient comfort.
- **Eases System Qualification** — Honeywell offers UL- and CSA-recognized components.
- **Flexible** — Numerous configurations (flat, transparent composite and high temperature), manufacturing materials (silicon, kapton, polyester Indium Tin Oxide and other flexible dielectric components) and watt densities (single or multiple) provide more options within the application.
- **High-Limit Temperature Controls** — A built-in temperature-detection device can help minimize system overheating.
- **Stable** — A uniform temperature minimizes heat loss.

Anesthesia Machine/Ventilator Diagram

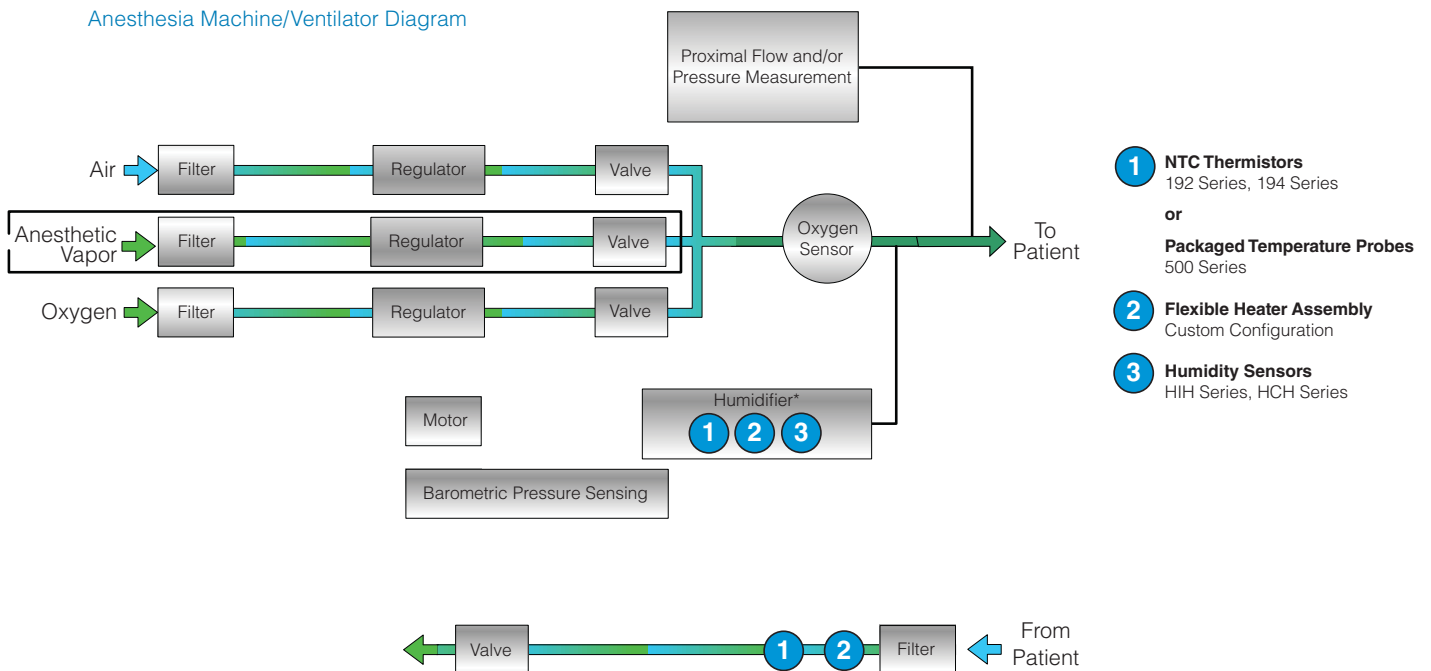

* Humidifier may be manufactured by a third party.



Customized to your Specifications

Honeywell will manufacture many thermal components to the ideal requirements needed for your sleep apnea machine's requirements.

SLEEP APNEA MACHINES

CHOOSING HONEYWELL: A DECISION THAT WON'T KEEP YOU UP AT NIGHT

Whether you're working on Continuous Positive Airway Pressure (CPAP), Automatic Positive Airway Pressure (Auto-PAP), or Bi-level Positive Airway Pressure (Bi-level-PAP) machines, Honeywell has the thermal management solution you need. From value-added heater assemblies to humidity sensors to pre-packaged temperature probes, Honeywell's vast thermal product line is your one-stop shop.

And, of course, since Honeywell can customize every product to your exact needs, the selection is virtually limitless.

HUMIDITY SENSORS

Honeywell HumidCon™ Digital Humidity/Temperature Sensor HIH6130/6131 Series, HIH-4000 Series, HIH-4020/4021 Series, HIH-4030/4031 Series, HIH-5030/5031 Series, HCH-1000 Series

Honeywell HumidCon™ Digital Humidity/Temperature Sensors provide highly accurate and stable relative humidity (RH) and temperature measurement to help enable the customer to determine dew point, thereby allowing the system to control the heat and humidity in the air at an optimum therapy level, and most importantly to the patient, enabling an uninterrupted night's sleep.

- **Industry-Leading Stability** — Honeywell HumidCon™ Sensors' stability of 1.2 %RH over 5 years eliminates your need to recalibrate the sensor in the application, minimizing system performance issues and supporting system uptime.
- **Lowest Total Cost Solution** — By combining a humidity and temperature sensor in the same package, Honeywell HumidCon™ Sensors eliminate the need for separate sensors in certain applications, while the industry-leading Total Error Band Accuracy of ±5 %RH eliminates individual sensor testing and calibration, supports system accuracy and warranty requirements, optimizes system uptime, and provides excellent sensor interchangeability.
- **Energy Efficient** — Honeywell HumidCon™ Sensors' low 2.3 Vdc supply voltage allows for use in low energy and wireless-compatible applications. Plus, the sleep mode feature reduces power consumption to maximize battery life and reduce both the power supply size and the application's overall weight.
- **Small** — The compact design lets you reduce the overall size of your PC board, providing you with options for use within the application.
- **Enhanced Accuracy** — The enhanced stability, accuracy and response time over the entire 0-100 %RH range supports demanding system performance requirements, even in many condensing environments.
- **Cost Effective** — With surface mount device (SMD) packaging on tape and reel, you can use Honeywell humidity sensors in automated, high-volume, lower-cost pick-and-place manufacturing.
- **Durable** — The multi-layer construction and a hydrophobic filter provide enhanced resistance to condensation and contaminants.



HIH6130/6131 Series HIH-4000 Series HIH-4020/4021 Series HIH-4030/4031 Series, HIH-5030/5031 Series HCH-1000 Series

FLEXIBLE HEATER ASSEMBLIES

A3100 Series, A3200 Series, A3400 Series, C3100 Series, C3200 Series, C3400 Series

A flexible heater is often required to warm water to vapor in the pump area to increase humidity to provide the comfortable breathing environment most preferred by patients. The heat is generally controlled by an onboard negative temperature coefficient (NTC) thermistor offering variable air temperature that can be used to adjust the vapor/air temperature to improve patient comfort.

- **Total Thermal Management Solution** — Value-added heater assemblies include mounting, temperature monitoring and control capabilities. Honeywell can design and manufacture complete heater turnkey assemblies, including supplying a vulcanized or adhered heater assembly to a heat plate, heat sink, mounting bracket or cover.
- **Uniform Heating** — Count on even heat distribution (no hot spots) across the heater surface.
- **Eases System Qualification** — Honeywell offers UL- and CSA-recognized components.
- **Flexible** — Numerous configurations (flat, transparent composite and high temperature), manufacturing materials (silicon, kapton, polyester Indium Tin Oxide and other flexible dielectric components) and watt densities (single or multiple) provide more options within the application.
- **High-Limit Temperature Controls** — A built-in temperature-detection device can help minimize system overheating.
- **Improves Patient Comfort** — Integration of mounting and sensing components allow for the desired vaporization of water.
- **Stable** — A uniform temperature minimizes heat loss.



3100 Series



3200 Series



3400 Series

THERMOSTATS

2450RC Series

Bimetallic commercial thermostats may be included in sleep apnea machines as on-board (stand-alone) devices on flexible heaters for temperature control without the need to add associated software or electronics.

- **Customizable** — Custom operating temperatures and tolerances fit customer-specific applications.
- **Flexible** — Wide variety of mounting brackets and terminals increase flexibility of use within the application.
- **Small** — Small product size often eases use in confined spaces.



2450RC Series

NTC THERMISTORS

192 Series, 194 Series

Temperature sensors are installed directly into the air stream in sleep apnea machines. They're designed to monitor the temperature of the air delivery system to provide the patient with a comfortable breathing situation at a desired level of warmth.

- **Accurate Performance** — Designed for enhanced accuracy and stability.
- **Cost Effective** — With Honeywell thermistors, the resistance temperature curve interchangeability offers standardization of circuit components and simplification of design/replacement.
- **Ease of Use** — Built to simplify design and replacement in temperature measurement, indication, control, and compensation of ambient temperature effects on a variety of integrated circuits and other semiconductor devices.
- **Small** — The compact size of Honeywell thermistors makes them easy to use in confined spaces.



192 Series

194 Series



500 Series

PRE-PACKAGED TEMPERATURE PROBES

500 Series

- **Accurate Performance** — Directs thermal or fluid flow evenly across thermistors for accurate temperature sensing.
- **Effective Design** — Protects the thermistors against damage in use or handling.
- **Flexible** — The wide operating temperature range of 60 °C to 300 °C (-76 °F to 572 °F), variety of housing materials (all plastic to all metal; accommodates air/gas, fluid immersion or surface sensing requirements), and resistance and termination options allow for flexibility of use within the application.

Sleep Apnea Machine Diagram

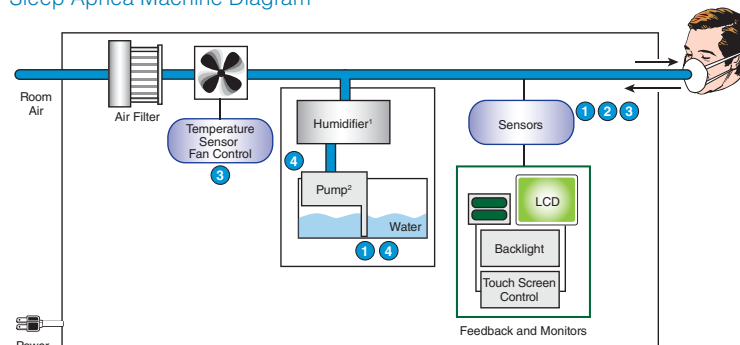

- 1 Flexible Heater Assembly
- 2 Humidity Sensors
HIH Series or HCH Series

- 3 NTC Thermistors
192 Series, 194 Series
or

Packaged Temperature Probes
500 Series

- 4 Commercial Thermostats
2450RC Series

¹ Humidifier may be designed in house or purchased from a third party.

² Some CPAP machines may not utilize a pump.

DIALYSIS MACHINES

FOR PRECISE FLUID DELIVERY,
CHOOSE HONEYWELL

Honeywell's thermal products help the dialysis machine manufacturer accurately deliver fluid to the patient at the precise body temperature, critical for proper treatment and the prevention of infection. Compact and streamlined for efficient, reliable performance, Honeywell products also can save you time, space and materials through easy customization. Whether you're building machines for kidney or peritoneal dialysis treatments, Honeywell products can be designed and built to the exact specifications you need.

Customized to your Specifications

Honeywell will manufacture many thermal components to your dialysis machine requirements.



FLEXIBLE HEATER ASSEMBLIES

A3100 Series, A3200 Series, A3400 Series,
C3100 Series, C3200 Series, C3400 Series

Honeywell's flexible heater assemblies use either heat exchange (constant temperature bath) or direct heat through warming plates to provide controlled heat for warming blood or dialysate to body temperature prior to re-entry into the body.

- **Total Thermal Management Solution** — Value-added heater assemblies include mounting, temperature monitoring and control capabilities. Honeywell can design and manufacture complete heater turnkey assemblies, including supplying a vulcanized or adhered heater assembly to a heat plate, heat sink, mounting bracket or cover.
- **Uniform Heating** — Count on even heat distribution (no hot spots) across the heater surface.
- **Eases System Qualification** — Honeywell offers UL- and CSA-recognized components.
- **Flexible** — Numerous configurations (flat, transparent composite and high temperature), manufacturing materials (silicon, kapton, polyester Indium Tin Oxide and other flexible dielectric components) and watt densities (single or multiple) provide more options within the application.
- **High-Limit Temperature Controls** — A built-in temperature-detection device can help minimize system overheating.
- **Improves Patient Comfort** — Integration of mounting and sensing components allow for the desired vaporization of water.
- **Stable** — A uniform temperature minimizes heat loss.



3100 Series



3200 Series



3400 Series

Dialysis Machine Diagram

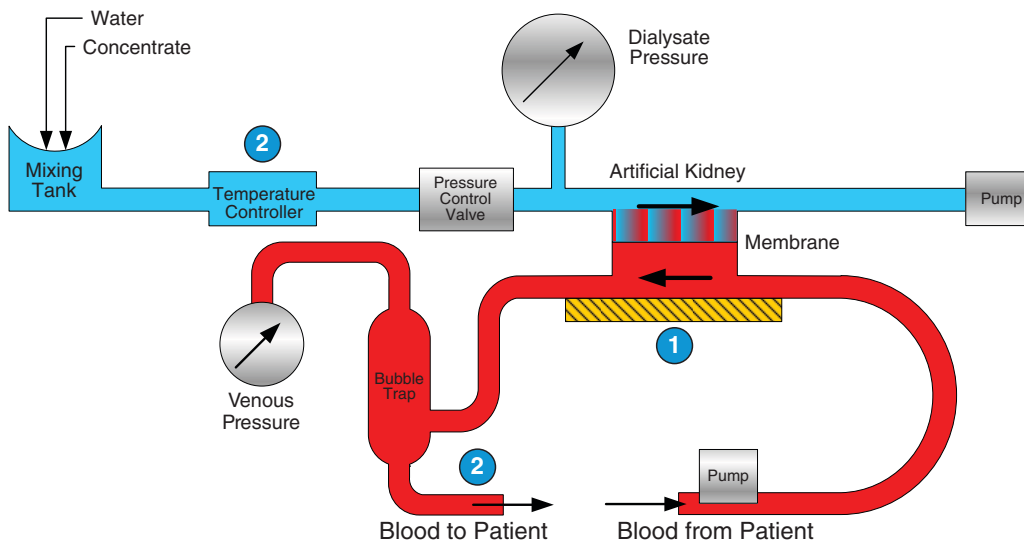

- 1 **Flexible Heater Assemblies**
A3100 Series, C3100 Series, A3200 Series,
C3200 Series, A3400 Series, C3400 Series
Custom Configuration
 - 2 **NTC Thermistors**
192 Series, 194 Series
- or
- Packaged Temperature Probes**
500 Series

NTC THERMISTORS

192 Series, 94 Series

Temperature sensors are installed directly into the dialysate temperature control system. They are designed to monitor the temperature of the fluid so that it is delivered to the patient at body temperature and at the desired level of comfort.

- **Accurate Performance** — Designed for enhanced accuracy and stability.
- **Cost Effective** — With Honeywell thermistors, the resistance temperature curve interchangeability offers standardization of circuit components and simplification of design/replacement.
- **Ease of Use** — Built to simplify design and replacement in temperature measurement, indication, control, and compensation of ambient temperature effects on a variety of integrated circuits and other semiconductor devices.
- **Small** — The compact size of Honeywell thermistors makes them easy to use in confined spaces.



PRE-PACKAGED TEMPERATURE PROBES

500 Series

- **Accurate Performance** — Directs thermal or fluid flow evenly across thermistors for accurate temperature sensing.
- **Effective Design** — Protects the thermistors against damage in use or handling.
- **Flexible** — The wide operating temperature range of 60 °C to 300 °C (-76 °F to 572 °F), variety of housing materials (all plastic to all metal; accommodates air/gas, fluid immersion or surface sensing requirements), and resistance and termination options allow for flexibility of use within the application.



INFUSION PUMPS

THE RELIABLE CHOICE IS HONEYWELL

Just as infusion pumps are designed to deliver precise amounts of medication, Honeywell flexible heater assemblies are designed for precise temperature control in infusion pumps. Built to conform to your infusion pump's surface, Honeywell flexible heater assemblies and transparent flexible heater assemblies deliver reliable, even heat to maintain the specific desired temperature.

Customized to your Specifications

Honeywell will manufacture many thermal components to the requirements of your infusion pumps.

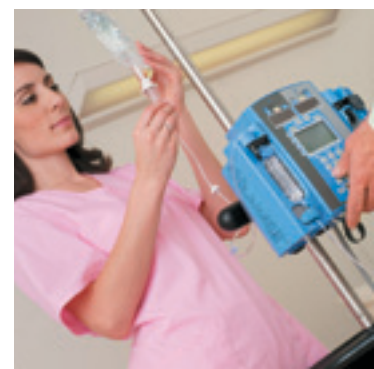



3400 Series



FLEXIBLE HEATER ASSEMBLIES

A3400 Series, C3400 Series

- **Total Thermal Management Solution** — Value-added heater assemblies include mounting, temperature monitoring and control capabilities. Honeywell can design and manufacture complete heater turnkey assemblies, including supplying a vulcanized or adhered heater assembly to a heat plate, heat sink, mounting bracket or cover.
- **Uniform Heating** — Count on even heat distribution (no hot spots) across the heater surface.
- **Eases System Qualification** — Honeywell offers UL- and CSA-recognized components.
- **Flexible** — Numerous configurations (flat, transparent composite and high temperature), manufacturing materials (silicon, kapton, polyester Indium Tin Oxide and other flexible dielectric components) and watt densities (single or multiple) provide more options within the application.
- **High-Limit Temperature Controls** — A built-in temperature-detection device can help minimize system overheating.



78000 Series

TRANSPARENT FLEXIBLE HEATER ASSEMBLIES

78000 Series

- **True Transparency** — By utilizing polyester ITO technology and material, Honeywell transparent flexible heater assemblies allow through at least 75% of visible light. Depending on the application, even more light can be allowed through.

Infusion Pump Diagram

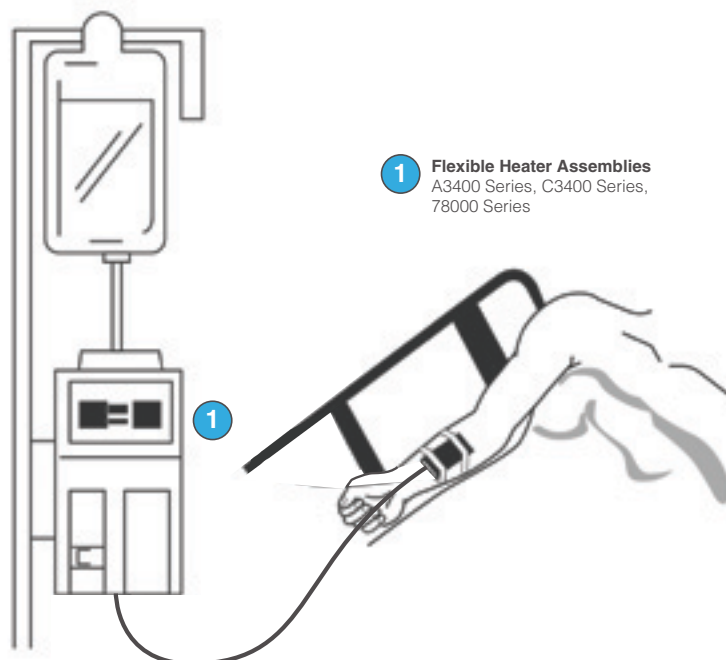



INFANT AND LABORATORY INCUBATORS

HONEYWELL — IDEAL SOLUTIONS FOR CREATING IDEAL CONDITIONS

The nurturing of a premature or congenitally ill infant requires careful control of temperature and humidity within the incubator. Not only must proper warmth be maintained, but that warmth must also be monitored to ensure proper humidity levels to avoid excessive loss of fluid from skin and respiratory evaporation and to maintain patient comfort.

Laboratory incubators are frequently used in medical laboratories. An example of this is culturing biological specimens or growing cell cultures. Honeywell thermal solutions provide the accuracy and reliability requirements that are vital to the equipment's design and performance, helping to prevent fogging while managing temperature and humidity conditions that are critical to properly controlling, monitoring, and completing the experiment.

HUMIDITY SENSORS

Honeywell HumidCon™ Digital Humidity/Temperature Sensor HIH6130/6131 Series, HIH-4000 Series, HIH-4020/4021 Series, HIH-4030/4031 Series, HIH-5030/5031 Series, HCH-1000 Series

Honeywell's humidity sensors monitor the infant or laboratory incubator system to maintain a specified level of humidification in the chamber with accurate dew point and absolute humidity and moisture measurement.

- **Industry-Leading Stability** — Honeywell HumidCon™ Sensors' stability of 1.2 %RH over 5 years eliminates your need to recalibrate the sensor in the application, minimizes system performance issues, and supports system uptime.
- **Lowest Total Cost Solution** — By combining a humidity and temperature sensor in the same package, Honeywell HumidCon™ Sensors eliminate the need for separate sensors in certain applications, while industry-leading Total Error Band Accuracy of ± 5 %RH eliminates individual sensor testing and calibration, supports system accuracy and warranty requirements, optimizes system uptime, and provides excellent sensor interchangeability.
- **Energy Efficient** — Honeywell HumidCon™ Sensors' low 2.3 Vdc supply voltage allows for use in low energy and wireless-compatible applications. Plus, the sleep mode feature reduces power consumption to maximize battery life and reduce both the power supply size and the application's overall weight.
- **Small** — The compact design lets you reduce the overall size of your PC board and gives you options for use within the application.
- **Enhanced Accuracy** — The enhanced stability, accuracy and response time over the entire 0-100 %RH range supports demanding system performance requirements, even in many condensing environments.
- **Cost Effective** — With surface mount device (SMD) packaging on tape and reel, you can use Honeywell humidity sensors in automated, high-volume, lower-cost pick-and-place manufacturing.
- **Durable** — The multi-layer construction and a hydrophobic filter provide enhanced resistance to condensation and contaminants.
- **Improves Patient Comfort** — Maintaining appropriate humidity levels inside the incubator reduces condensation and prevents fogging to improve visibility and patient comfort.



HIH6130/6131 Series HIH-4000 Series HIH-4020/4021 Series HIH-4030/4031 Series, HIH-5030/5031 Series HCH-1000 Series

Customized to your Specifications

Honeywell will manufacture many thermal components to the requirements of your infant and laboratory incubators.



NTC THERMISTORS

192 Series, 194 Series

Honeywell discrete thermistor temperature sensors are installed directly into the air stream to monitor the air temperature. The sensor is coupled to a microcontroller designed to measure air stream temperature and interact with the controller that regulates the temperature of the air stream. You can choose packaged sensors as components for your assemblies, or Honeywell can provide a fully assembled solution you can integrate into your system.

- **Accurate Performance** — Designed for enhanced accuracy and stability.
- **Cost Effective** — With Honeywell thermistors, the resistance temperature curve interchangeability offers standardization of circuit components and simplification of design/replacement.
- **Flexible** — Bare leads (192 Series) or insulated leads (194 Series) give you versatility within your application.
- **Small** — The compact size of Honeywell thermistors makes them easy to use in confined spaces.
- **Improves Patient Comfort** — Helps maintain desired temperature inside the incubator.



192 Series



194 Series



2450RC Series

THERMOSTATS

2450RC Series

Honeywell thermostats help provide overtemperature protection for the heater element. It is installed in series with the main heating unit and disconnects power to the heater if the temperature reaches a pre-set overtemperature limit as set by the operator.

- **Cost Effective** — Simple design approach for standalone power interruption to the main heater unit.
- **High-Limit Temperature Controls** — A built-in temperature-detection device can help minimize system overheating.
- **Improves System Performance and Safety** — Helps maintain proper temperature.
- **Flexible** — Variety of housing materials, reset options (one-shot, manual, or auto), temperature set points, mounting and termination styles allows for flexibility of use within the application.

Incubator Diagram

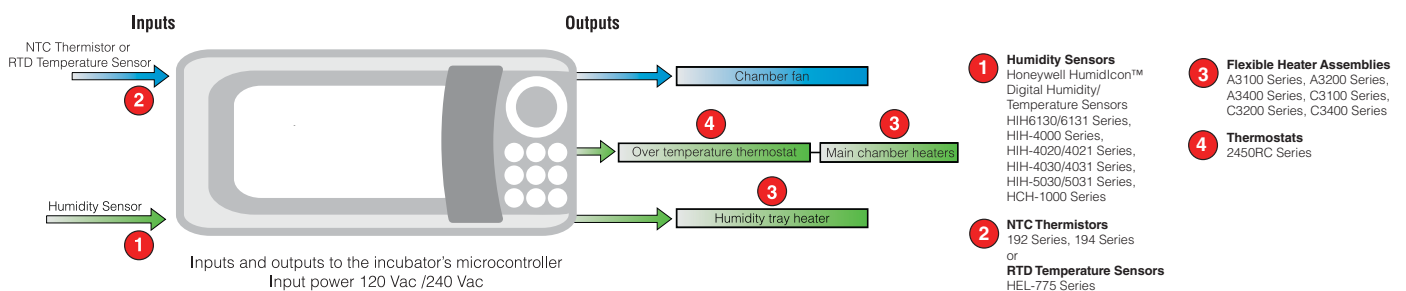

FLEXIBLE HEATER ASSEMBLIES

A3100 Series, A3200 Series, A3400 Series, C3100 Series, C3200 Series, C3400 Series

Flexible heater assemblies can be applied to the incubator door to help heat the incubator's internal temperature and to also maintain clear visibility through the door wall.

- **Total Thermal Management Solution** — Value-added heater assemblies include mounting, temperature monitoring and control capabilities. Honeywell can design and manufacture complete heater turnkey assemblies, including supplying a vulcanized or adhered heater assembly to a heat plate, heat sink, mounting bracket or cover.
- **Uniform Heating** — Count on even heat distribution (no hot spots) across the heater surface.
- **Eases System Qualification** — Honeywell offers UL- and CSA-recognized components.
- **Flexible** — Numerous configurations (flat, transparent composite and high temperature), manufacturing materials (silicon, kapton, polyester Indium Tin Oxide and other flexible dielectric components) and watt densities (single or multiple) provide more options within the application.
- **High-Limit Temperature Controls** — A built-in temperature-detection device can help minimize system overheating.
- **Stable** — A uniform temperature minimizes heat loss.



3100 Series



3200 Series



3400 Series



HEL-775 Series

RTD TEMPERATURE SENSORS

HEL-775 Series

Some customers may choose to integrate platinum-based RTDs into infant or laboratory incubators because of their linear resistance output and the ease of interfacing it with their microcontrollers.

- **Flexible** — Linear resistance versus temperature output allows for direct interfacing with the microcontroller.
- **Accuracy and Interchangeability** — Helps eliminate additional signal conditioning and calibration at the OEM.
- **Stable** — Helps support long term system performance, uptime, and warranty requirements.
- **Durable** — Thin film platinum technology provides enhanced durability
- **Small** — The compact size of Honeywell RTDs makes them easy to use in confined spaces.
- **Ceramic SIP Package with Solderable Leads** — Provides strong connections for wires or printed circuits.

DIAGNOSTIC EQUIPMENT

HONEYWELL — PROVIDING ACCURATE HEATING SOLUTIONS

Accuracy and reliability are essential for medical equipment used in laboratories to analyze body fluid. Honeywell thermal solutions help eliminate variables through even, accurate heating that maintains the fluid at the desired temperature.

Whether your equipment tests one type of fluid or several, and whether containers or vials are used to transfer the fluid to the equipment, Honeywell can provide a thermal management system customized to your equipment needs. Honeywell will work with your specifications to design heater geometry and sensor placement for your control circuitry and application.

Customized to your Specifications

Honeywell will manufacture many thermal components to your diagnostic equipment's requirements.





3100 Series

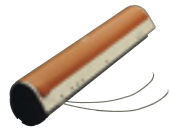

3200 Series



3400 Series



FLEXIBLE HEATER ASSEMBLIES

[A3100 Series](#), [A3200 Series](#), [A3400 Series](#), [C3100 Series](#), [C3200 Series](#), [C3400 Series](#)

- **Total Thermal Management Solution** — Value-added heater assemblies include mounting, temperature monitoring and control capabilities. Honeywell can design and manufacture complete heater turnkey assemblies, including supplying a vulcanized or adhered heater assembly to a heat plate, heat sink, mounting bracket or cover.
- **Uniform Heating** — Count on even heat distribution (no hot spots) across the heater surface.
- **Eases System Qualification** — Honeywell offers UL- and CSA-recognized components.
- **Flexible** — Numerous configurations (flat, transparent composite and high temperature), manufacturing materials (silicon, kapton, polyester Indium Tin Oxide and other flexible dielectric components) and watt densities (single or multiple) provide more options within the application.
- **High-Limit Temperature Controls** — A built-in temperature-detection device can help minimize system overheating.
- **Stable** — A uniform temperature minimizes heat loss.



NTC THERMISTORS

[192 Series](#), [194 Series](#)

192 Series

194 Series

- **Accurate Performance** — Designed for enhanced accuracy and stability.
- **Cost Effective** — With Honeywell thermistors, the resistance temperature curve interchangeability offers standardization of circuit components and simplification of design/replacement.
- **Flexible** — Bare leads (192 Series) or insulated leads (194 Series) give you versatility within your application.
- **Small** — The compact size of Honeywell thermistors makes them easy to use in confined spaces.

Example of a Customized Flexible Heater Assembly for a Centrifuge

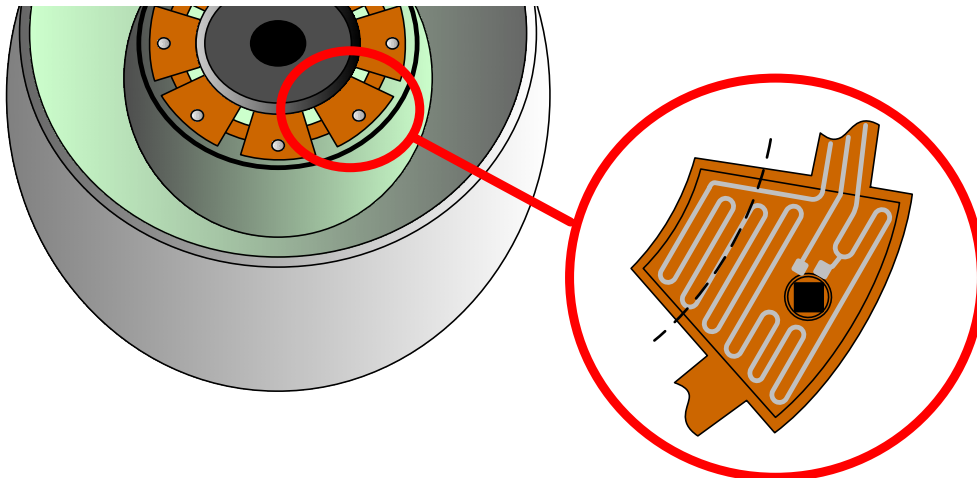

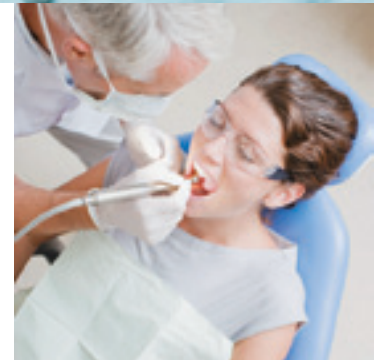

AUTOCLAVES

HONEYWELL'S HISTORY OF PROVIDING PRECISE CONTROL

Small autoclaves are used to steam-sterilize small medical instruments, such as those used in dentistry. Patients trust their medical care provider to use clean and sterile instruments.

Honeywell's flexible heater assemblies are designed so that the products being sterilized in the autoclave equipment reach the proper sterilization temperatures/conditions during the cleaning cycle. It's common for flexible heaters used in autoclaves to be large and wrap completely around the autoclave. Honeywell can integrate a thermostat, an NTC (negative temperature coefficient) thermistor, or a discrete RTD (resistance temperature detector) sensor for self-contained duty cycle control — whatever you need to meet your exact control requirements.

**Customized to your
Specifications**
Honeywell will manufacture
many thermal components
to the requirements of
your autoclave.



3100 Series



3200 Series



3400 Series



FLEXIBLE HEATER ASSEMBLIES

A3100 Series, A3200 Series, A3400 Series, C3100 Series, C3200 Series, C3400 Series

- **Total Thermal Management Solution** — Value-added heater assemblies include mounting, temperature monitoring and control capabilities. Honeywell can design and manufacture complete heater turnkey assemblies, including supplying a vulcanized or adhered heater assembly to a heat plate, heat sink, mounting bracket or cover.
- **Uniform Heating** — Count on even heat distribution (no hot spots) across the heater surface.
- **Eases System Qualification** — Honeywell offers UL- and CSA-recognized components.
- **Flexible** — Numerous configurations (flat, transparent composite and high temperature), manufacturing materials (silicon, kapton, polyester Indium Tin Oxide and other flexible dielectric components) and watt densities (single or multiple) provide more options within the application.
- **High-Limit Temperature Controls** — A built-in temperature-detection device can help minimize system overheating.
- **Stable** — A uniform temperature minimizes heat loss.



500 Series

TEMPERATURE PROBES

500 Series

Autoclaves use the power of high-pressure steam to effectively disinfect. Temperature probes may be used to increase the autoclave's system temperature to the appropriate level, generally 121 °C [250 °F] over a period of time, in which to disinfect. If the appropriate temperature isn't accurately maintained, contamination of the instruments can occur and may cause an infection to the patient.

- **Accurate** — Count on accurate temperature sensing so that the autoclave reaches the right temperature, as set by the system, so that microbes are killed.
- **Durable** — Stainless steel, corrosion-resistant packaging allows for use with various types of chemicals.
- **Easy to Install** — Threaded housing style eases installation.
- **Stable** — Enhanced stability of the output over the life of the application leads to enhanced reliability.

Sales and Service

Honeywell serves its customers through a worldwide network of sales offices, representatives and distributors.

For application assistance, current specifications, pricing or name of the nearest Authorized Distributor, contact your local sales office or:

E-mail: info.sc.honeywell.com

Internet: www.honeywell.com/sensing

Phone and Fax:

Asia Pacific	+65 6355-2828
	+65 6445-3033 Fax
Europe	+44 (0) 1698 481481
	+44 (0) 1698 481676 Fax
Latin America	+1-305-805-8188
	+1-305-883-8257 Fax
USA/Canada	+1-800-537-6945
	+1-815-235-6847
	+1-815-235-6545 Fax

Sensing and Control

Honeywell
1985 Douglas Drive North
Golden Valley, MN 55422
www.honeywell.com/sensing

Warranty/Remedy

Honeywell warrants goods of its manufacture as being free of defective materials and faulty workmanship. Honeywell's standard product warranty applies unless agreed to otherwise by Honeywell in writing; please refer to your order acknowledgement or consult your local sales office for specific warranty details. If warranted goods are returned to Honeywell during the period of coverage, Honeywell will repair or replace, at its option, without charge those items it finds defective. **The foregoing is buyer's sole remedy and is in lieu of all other warranties, expressed or implied, including those of merchantability and fitness for a particular purpose. In no event shall Honeywell be liable for consequential, special, or indirect damages.**

While we provide application assistance personally, through our literature and the Honeywell website, it is up to the customer to determine the suitability of the product in the application.

Specifications may change without notice. The information we supply is believed to be accurate and reliable as of this printing. However, we assume no responsibility for its use.

Honeywell