

HF7000-200

Fiber Optic Component 50 Mbps, 650 nm LED



DESCRIPTION

The HF7000-200 is a 50 Mbps LED designed to meet data transmission requirements in factory or office automation. The 650 nm wavelength provides operation in the low attenuation area of PMMA (Polymethylmethacrylat) fibers. The metal SMA housing gives the user a cost-effective module which can be

easily mounted on the PCB while also offering improved mechanical robustness and EMC protection versus plastic packages. The HF7000-200 is designed to work with Honeywell's high speed receivers HF7000-XXX and HFD7500-XXX, and is pin compatible with Honeywell's HF6015-200.

FEATURES

- Super bright LED for optical fiber communication
- Integrated lens provides maximum coupling into plastic fibers
- High power output at 650 nm
- High speed (50 Mbps)
- High reliability
- Designed to meet SERCOS requirement

POTENTIAL APPLICATIONS

- Data transmission in factory automation and office
- High speed and short distance links

HFX7000-200

ABSOLUTE MAXIMUM RATINGS¹

Parameter	Symbol	Rating
Forward current	I _f	40 mA
Reverse voltage	V _R	5 V
Power dissipation*	P _{MAX}	250 mW
Soldering temperature	T _{SOLD}	250 °C for 5 seconds
Operating temperature	T _{OP}	-40 °C to 85 °C [-40 °F to 185 °F]
Storage temperature	T _{STOR}	-40 °C to 85 °C [-40 °F to 185 °F]

Notes:

* Derate power dissipation at a rate of 1.7 mW/°C above T_A = 25 °C [77 °F]

ELECTRO-OPTICAL CHARACTERISTICS (T_A = 25 °C [77 °F])

Parameter	Condition	Symbol	Minimum	Typical	Maximum	Unit
Data rate	Driven by recommended circuit	f _D	DC		50	Mbps
Forward voltage	I _f = 20 mA	V _f		1.9	2.3	V
Reverse current	V _r = 5 V	I _r			10	μA
Output power	I _f = 10 mA	P _o	-7 (200)		-4 (400)	dBm (μW)
	I _f = 20 mA	P _o	-5 (315)		-1 (795)	dBm (μW)
Peak wavelength	I _f = 20 mA	λ _p		350		nm
Spectral halfwidth ¹	I _f = 20 mA	Δλ		20		nm
Rise time ²	I _f = 20 mA	t _r			8	ns
Fall time ²	I _f = 20 mA	t _f			8	ns

¹ Output from a 1 m long, 1 mm diameter plastic fiber (GH4001 made by Mitsubishi Rayon). Measured with recommended drive circuit.

² Time required for change in the output as shown below. Measured with recommended drive circuit (Figure 4)

TYPICAL OUTPUT WAVEFORM

(T_A = 25 °C [77 °F], I_f = 20 mA, 5ns/div)

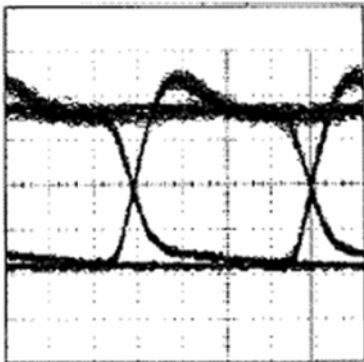

RISE/FALL TIME

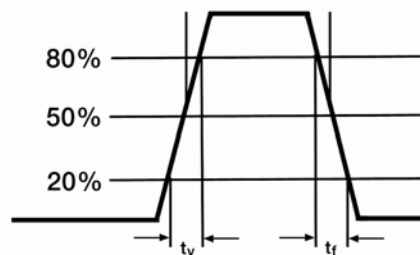

ORDER GUIDE

Catalog listing	Description
HFX7000-200	650 nm LED in metal SMA-housing

50 Mbps, 650 nm LED

FIGURE 1. TYPICAL LIGHT OUTPUT VS. LED CURRENT

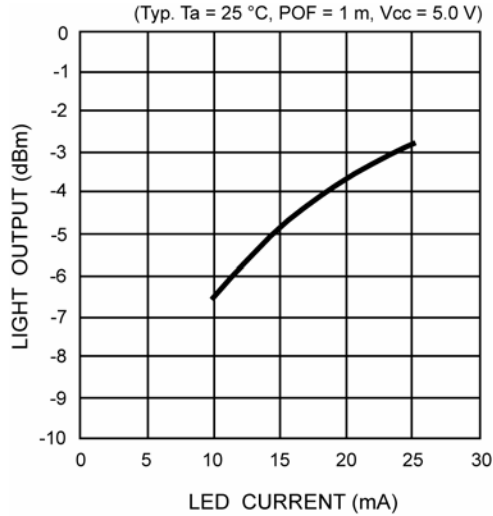

FIGURE 2. TYPICAL EMISSION SPECTRUM

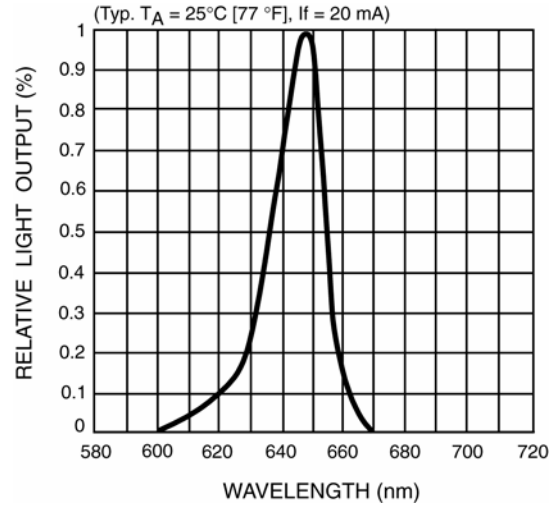

FIGURE 3. TYPICAL LIGHT OUTPUT VS. TEMP

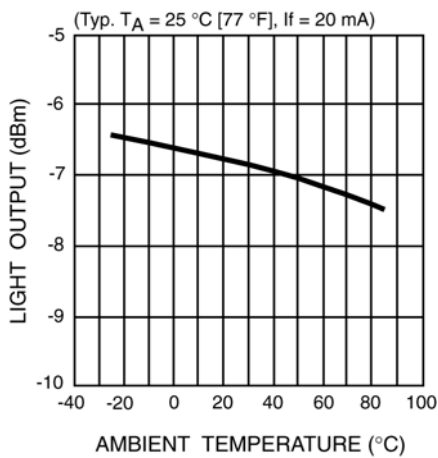
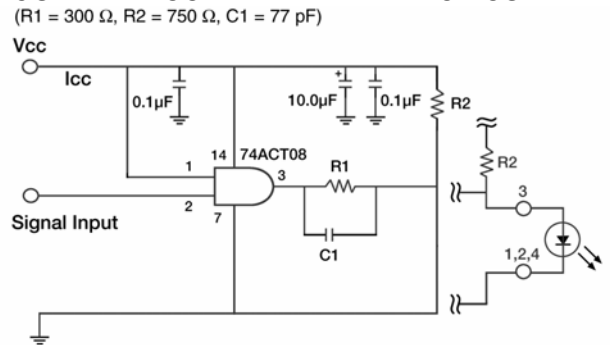

FIGURE 4. RECOMMENDED DRIVE CIRCUIT



NOTICE

The inherent design of this component causes it to be sensitive electrostatic discharge (ESD). To prevent ESD-included damage and/or degradation to equipment, take normal ESD precautions when handling this product.

HFX7000-200

OUTPUT POWER VS. FORWARD CURRENT

Condition: POF 1 m, $T_A = 25^\circ\text{C}$ [77 °F]

* At Watt

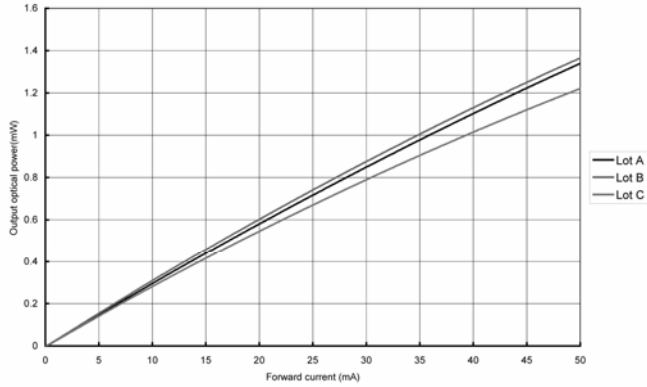

* At dBm

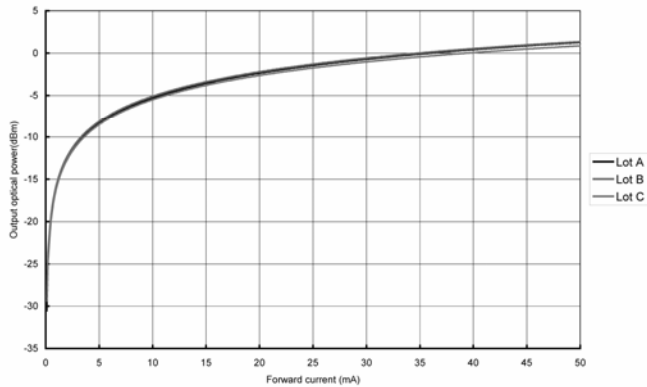

OUTPUT POWER VS. FORWARD CURRENT TEMPERATURE CHARACTERISTICS

Condition: POF 1 m

* At Watt

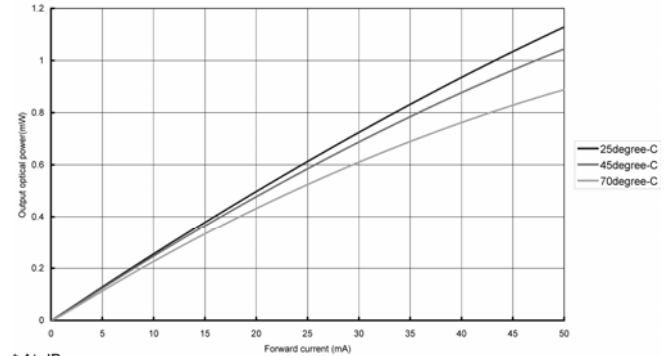

* At dBm

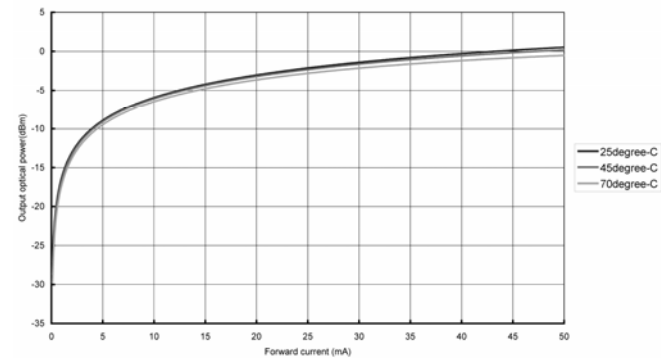

FORWARD VOLTAGE VS. FORWARD CURRENT

$T_A = 25^\circ\text{C}$ [77 °F]

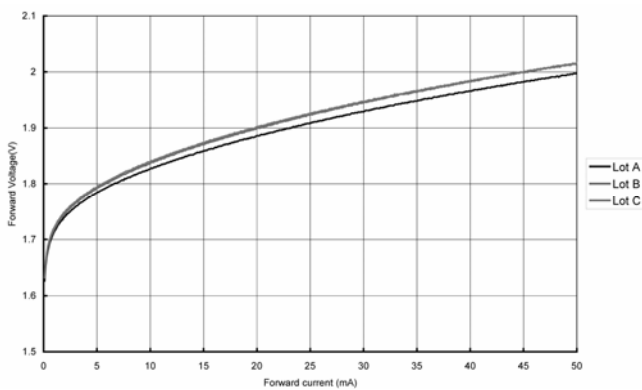

FORWARD VOLTAGE VS. FORWARD CURRENT TEMPERATURE CHARACTERISTIC

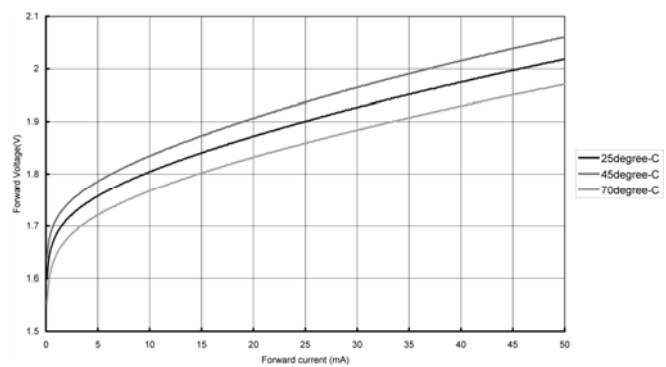

50 Mbps, 650 nm LED

ABSOLUTE MAXIMUM RATING

Maximum forward current (whole temperature range)

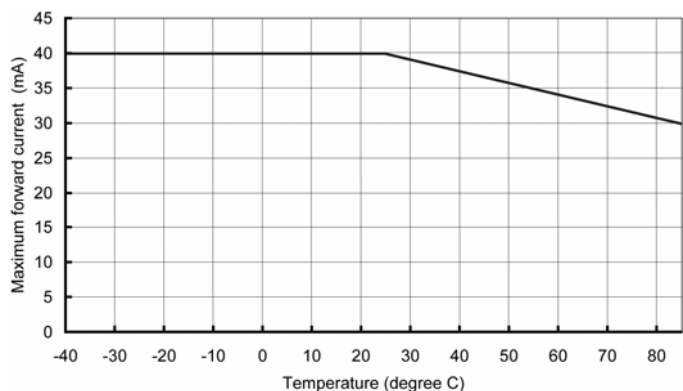

PINOUT

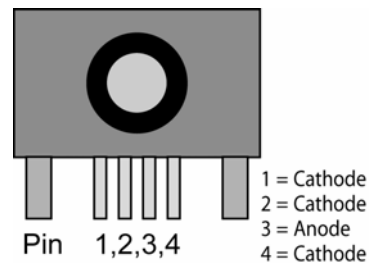

MTTF VALUE

The estimation of MTTF (the average time down to 50% from the initial value) is as follows:

Condition	T _A = 25 °C [77 °F]	T _A = 45 °C [113 °F]	T _A = 70 °C [158 °F]	T _A = 85 °C [185 °F]
I _f = 1 mA	6.1 x 10 ⁸	1.1 x 10 ⁸	1.7 x 10 ⁷	6.4 x 10 ⁶
I _f = 10mA	3.8 x 10 ⁷	7.4 x 10 ⁶	1.2 x 10 ⁶	4.7 x 10 ⁵
I _f = 20 mA	1.2 x 10 ⁷	2.4 x 10 ⁶	4.2 x 10 ⁵	1.7 x 10 ⁵
I _f = 30 mA	4.9 x 10 ⁶	1.0 x 10 ⁶	1.9 x 10 ⁵	7.9 x 10 ⁴
I _f = 40 mA	2.3 x 10 ⁶	—	—	—

DIMENSIONS

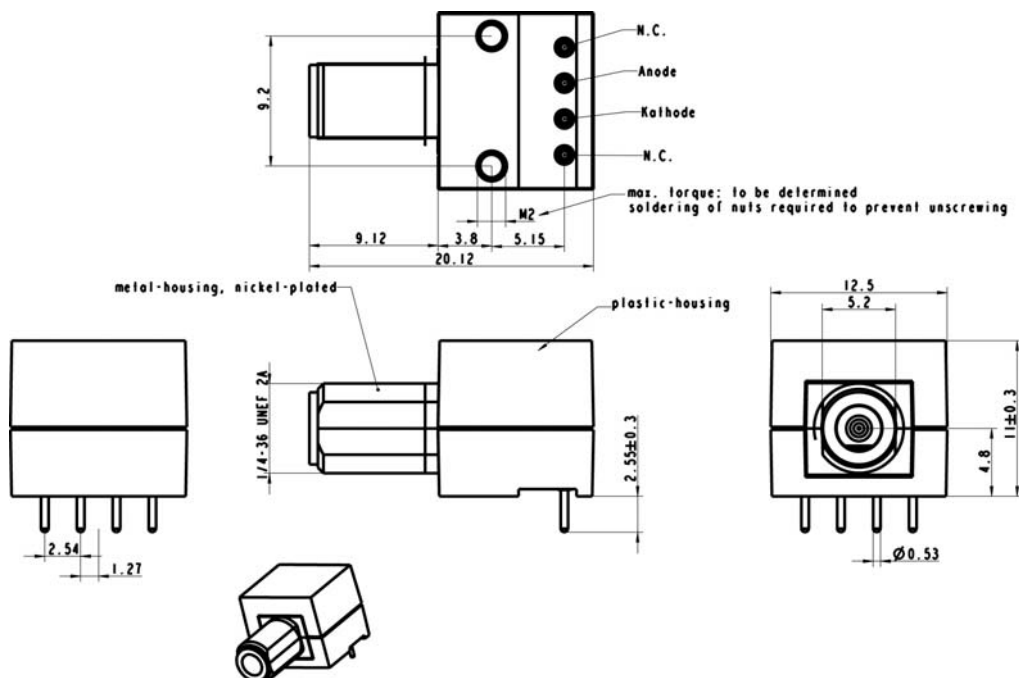

WARNING

MISUSE OF DOCUMENTATION

- The information presented in this product sheet is for reference only. Do not use this document as a product installation guide.
- Complete installation, operation, and maintenance information is provided in the instructions supplied with each product.

Failure to comply with these instructions could result in death or serious injury.

WARRANTY/REMEDY

Honeywell warrants goods of its manufacture as being free of defective materials and faulty workmanship. Honeywell's standard product warranty applies unless agreed to otherwise by Honeywell in writing; please refer to your order acknowledgement or consult your local sales office for specific warranty details. If warranted goods are returned to Honeywell during the period of coverage, Honeywell will repair or replace, at its option, without charge those items it finds defective. **The foregoing is buyer's sole remedy and is in lieu of all other warranties, expressed or implied, including those of merchantability and fitness for a particular purpose. In no event shall Honeywell be liable for consequential, special, or indirect damages.**

While we provide application assistance personally, through our literature and the Honeywell web site, it is up to the customer to determine the suitability of the product in the application.

Specifications may change without notice. The information we supply is believed to be accurate and reliable as of this printing. However, we assume no responsibility for its use.

WARNING

PERSONAL INJURY

DO NOT USE these products as safety or emergency stop devices or in any other application where failure of the product could result in personal injury.

Failure to comply with these instructions could result in death or serious injury.

NOTICE

Stress greater than those listed under "Absolute Maximum Ratings" may cause permanent damage to the device. This is a stress rating only, and functional operation of the device at these or any other conditions above those indicated in the operational section of this specification is not implied.

Exposure to absolute maximum rating conditions for extended periods of time may affect reliability.

SALES AND SERVICE

Honeywell serves its customers through a worldwide network of sales offices, representatives and distributors. For application assistance, current specifications, pricing or name of the nearest Authorized Distributor, contact your local sales office or:

E-mail: info.sc@honeywell.com

Internet: www.honeywell.com/sensing

Phone and Fax:

Asia Pacific	+65 6355-2828
	+65 6445-3033 Fax
Europe	+44 (0) 1698 481481
	+44 (0) 1698 481676 Fax
Latin America	+1-305-805-8188
	+1-305-883-8257 Fax
USA/Canada	+1-800-537-6945
	+1-815-235-6847
	+1-815-235-6545 Fax

Sensing and Control
Honeywell
1985 Douglas Drive North
Minneapolis, MN 55422
www.honeywell.com/sensing

00XXXXX-1-EN IL50 GLO Printed in USA
April 2007
© 2007 Honeywell International Inc. All rights reserved..

Honeywell