

## ANALOG FUNCTION SWITCH

### ■ GENERAL DESCRIPTION

The NJU7311A is a hexad 2-channel and dual 1-channel analog function switch, especially suitable for input selector of audio equipments.

The high break down voltage analog switch controlled by 14-bit serial data based on logic operating voltage (5V) can ON and OFF of  $\pm 15V$  signal.

The analog switch is realized superior linearity of on-resistance in all voltage range, low distortion and wide dynamic range.

Furthermore, the both of single and dual power supply application provides easy designing.

### ■ PACKAGE OUTLINE

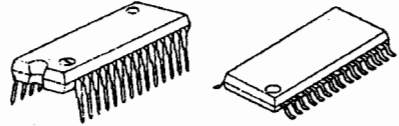

NJU7311AL

NJU7311AM

### ■ FEATURES

- Analog switch: hexad 2 channel and dual 1 channel.
- High Break Down Voltage  $\pm 15V$ .
- Low Distortion THD: 0.002% (typ).
- Superior Linearity of ON Resistance.
- Serial Data Control.
- Package Outline SDIP 28 / SDMP30
- C-MOS Technology

### ■ PIN CONFIGURATION

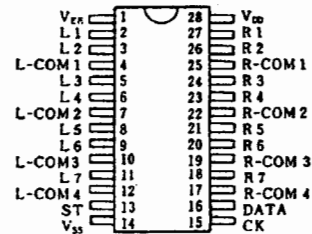

### ■ BLOCK DIAGRAM

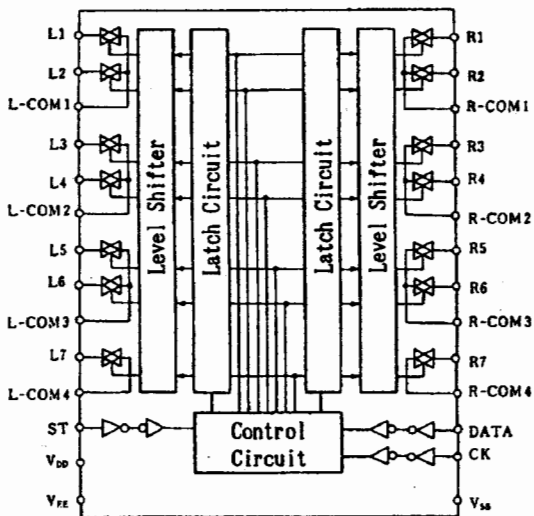

NJU7311AL

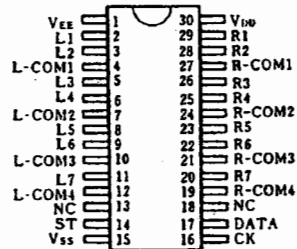

NJU7311AM

**TERMINALS DESCRIPTION**

No.		SYMBOL	FUNCTIONS	No.		SYMBOL	FUNCTIONS
DIP	DMP			DIP	DMP		
1	1	V <sub>EE</sub>	Negative Voltage Supply	15	16	CK	Clock input
2	2	L1	Analog switch input/output	16	17	DATA	Data input
3	3	L2		17	19	R-COM4	R7 Common
4	4	L-COM1	L1, L2 Common	18	20	R7	Analog switch input/output
5	5	L3	Analog switch input/output	19	21	R-COM3	R5, R6 Common
6	6	L4		20	22	R6	Analog switch input/output
7	7	L-COM2	L3, L4 Common	21	23	R5	
8	8	L5	Analog switch input/output	22	24	R-COM2	R3, R4 Common
9	9	L6		23	25	R4	Analog switch input/output
10	10	L-COM3	L5, L6 Common	24	26	R3	
11	11	L7	Analog switch input/output	25	27	R-COM1	R1, R2 Common
12	12	L-COM4	L7 Common	26	28	R2	Analog switch input/output
13	14	ST	Chip enable	27	29	R1	
14	15	V <sub>SS</sub>	GND	28	30	V <sub>DD</sub>	Positive voltage supply

**FUNCTIONAL DESCRIPTION**

## (1) Timing of DATA, CK, ST

The Serial Input Data is input to internal shift register sequentially synchronized by clock signal rising edge input from CK terminal (100 kHz max.).

The Serial Input Data in the shift register is transferred to latch circuit and renew by synchronized rising edge of Chip enable signal input from ST terminal.

(Timing Chart)

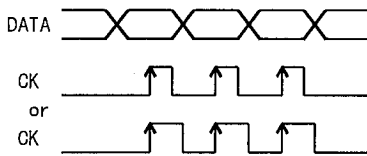

(Detailed Timing)

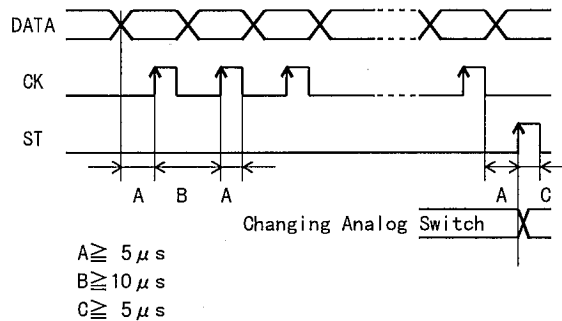

## (2) Data Format

The 14-bit serial data strings format from MSB to LSB are 8-bit analog switch control data, 2-bit right and left channel selection data and 4-bit address data.

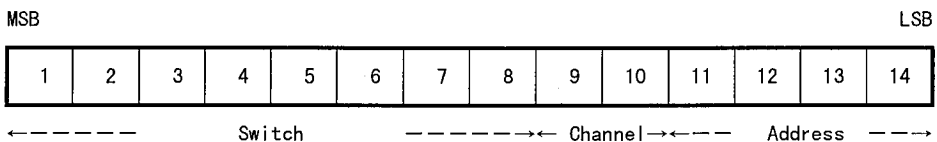



**■ ABSOLUTE MAXIMUM RATINGS**

(Ta=25°C)

PARAMETER	SYMBOL	RATINGS	UNIT
Supply Voltage	$V_{DD} - V_{EE}$ $V_{DD} - V_{SS}$ $V_{EE} - V_{SS}$	34 +17 -17	V
Input Voltage	$V_{IN}$	$V_{SS}-0.3 \sim V_{DD}+0.3$	V
Power Dissipation	$P_D$	300	mW
Operating Temperature	$T_{opr}$	-30 ~ +75	°C
Storage Temperature	$T_{stg}$	-40 ~ +125	°C

**■ ELECTRICAL CHARACTERISTICS**

 (V<sub>DD</sub>=+16V, V<sub>SS</sub>=0V, V<sub>EE</sub>=-16V, Ta=25°C)

PARAMETER	SYMBOL	CONDITIONS	MIN	TYP	MAX	UNIT
Operating Voltage	$V_{DD}-V_{SS}$ $V_{EE}-V_{SS}$		8 -16		16 -8	V
Operating Current	$I_{DD}$	V <sub>DD</sub> =+16V, V <sub>EE</sub> =-16V, V <sub>SS</sub> =0V			3	mA
Back-Up Voltage	$V_B$		4		16	V
Back-Up Current	$I_B$	V <sub>DD</sub> =+4V, V <sub>SS</sub> =V <sub>EE</sub> =0V, Circ.1			10	μA
High-Level Input Voltage	$V_{IH}$	CK, DATA, ST Terminals	4		16	V
Low-Level Input Voltage	$V_{IL}$	CK, CATA, ST Terminals	0		1	V
Min. Operating Pulse Width	$t_{MIN}$		5			μS
Switch ON Resistance	$R_{ON}$	Circ.2		100	200	Ω
Total Harmonic Distortion	THD	f <sub>IN</sub> =20~20kHz, V <sub>IN</sub> =1V <sub>r.m.s.</sub> Circ.3		0.002	0.005	%

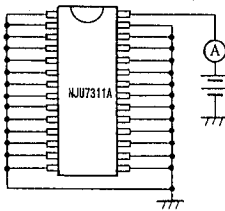
**6**
**■ MEASUREMENT CIRCUIT DIAGRAMS**

( Circ.1 )

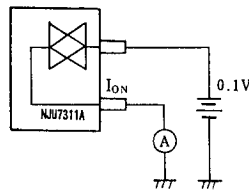

( Circ.2 )

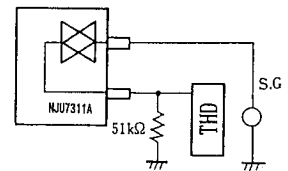

( Circ.3 )

## MEMO

**[CAUTION]**

The specifications on this databook are only given for information, without any guarantee as regards either mistakes or omissions. The application circuits in this databook are described only to show representative usages of the product and not intended for the guarantee or permission of any right including the industrial rights.