

HOA1397

Reflective Sensor

FEATURES

- Choice of phototransistor or photodarlington output
- Low profile for design flexibility
- Unfocused for sensing diffused surfaces

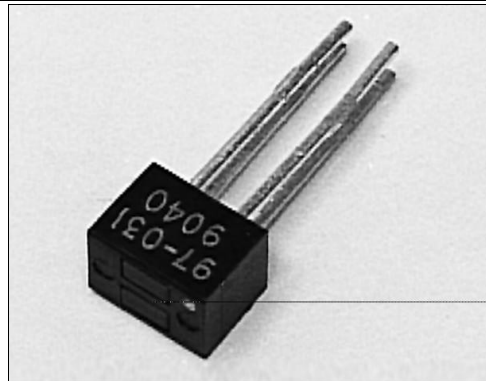

INFRA-10.TIF

DESCRIPTION

The HOA1397 series consists of an infrared emitting diode and an NPN silicon phototransistor (HOA1397-001, -002) or photodarlington (HOA1397-031, 032) encased side-by-side on parallel axes in a miniature black thermoplastic housing. The detector responds to radiation from the IRED only when a reflective object passes within its field of view. The HOA1397 series employs plastic molded components. For additional component information refer to SEP8507 and SDP8407.

Housing material is polyester. Housings are soluble in chlorinated hydrocarbons and ketones. Recommended cleaning agents are methanol and isopropanol.

OUTLINE DIMENSIONS in inches (mm)

Tolerance 3 plc decimals ±0.010(0.25)
2 plc decimals ±0.020(0.51)

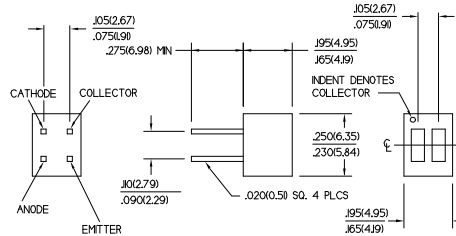

DIM_036.cdr

HOA1397

Reflective Sensor

ELECTRICAL CHARACTERISTICS (25°C unless otherwise noted)

PARAMETER	SYMBOL	MIN	TYP	MAX	UNITS	TEST CONDITIONS
IR EMITTER						
Forward Voltage	V_F			1.6	V	$I_F=20\text{ mA}$
Reverse Leakage Current	I_R			10	μA	$V_R=3\text{ V}$
DETECTOR						
Collector-Emitter Breakdown Voltage HOA1397-001, -002 HOA1397-031, -032	$V_{(BR)CEO}$	30 15			V	$I_C=100\ \mu\text{A}$
Emitter-Collector Breakdown Voltage	$V_{(BR)ECO}$	5.0			V	$I_E=100\ \mu\text{A}$
Collector Dark Current HOA1397-001, -002 HOA1397-031, -032	I_{CEO}			100 250	nA	$V_{CE}=10\text{ V}$ $I_F=0$
COUPLED CHARACTERISTICS						
On-State Collector Current HOA1397-001 HOA1397-002 HOA1397-031 HOA1397-032	$I_{C(ON)}$	0.2 0.7 2.0 7.0			mA	$V_{CE}=5\text{ V}$ $I_F=20\text{ mA}$ (1)
Collector-Emitter Saturation Voltage HOA1397-001 HOA1397-002 HOA1397-031 HOA1397-032	$V_{CE(SAT)}$			0.4 0.4 1.1 1.1	V	$I_F=20\text{ mA}$ (1) $I_C=30\ \mu\text{A}$ $I_C=90\ \mu\text{A}$ $I_C=250\ \mu\text{A}$ $I_C=880\ \mu\text{A}$
Rise And Fall Time HOA1397-001, -002 HOA1397-031, -032	t_r, t_f		15 75		μs	$V_{CC}=5\text{ V}, I_C=1\text{ mA}$ $R_L=1000\ \Omega$ $R_L=100\ \Omega$

Notes

1. Test surface is a Eastman Kodak Neutral white test card with 90% diffuse reflectance located 0.05 in. (1.27 mm) from the front surface of the device.

ABSOLUTE MAXIMUM RATINGS

(25°C Free-Air Temperature unless otherwise noted)

Operating Temperature Range -40°C to 85°C

Storage Temperature Range -40°C to 85°C

Soldering Temperature (5 sec) 240°C

IR EMITTER

Power Dissipation 100 mW (1)

Reverse Voltage 3 V

Continuous Forward Current 60 mA

DETECTOR

Collector-Emitter Voltage 30 V

Emitter-Collector Voltage 5 V

Power Dissipation 100 mW (1)

Collector DC Current 30 mA

TRANS. DARLINGTON

15 V

5 V

100 mW (1)

30 mA

SCHEMATIC

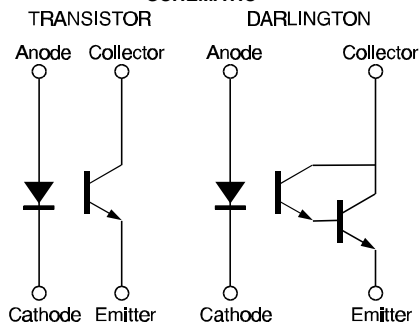

Honeywell reserves the right to make changes in order to improve design and supply the best products possible.

Honeywell

HOA1397

Reflective Sensor

Fig. 1 IRED Forward Bias Characteristics

gra_073.ds4

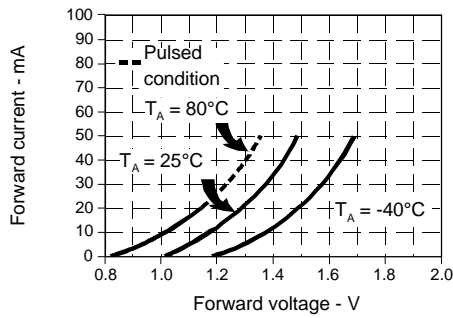

Fig. 2 Non-Saturated Switching Time vs Load Resistance

gra_079.ds4

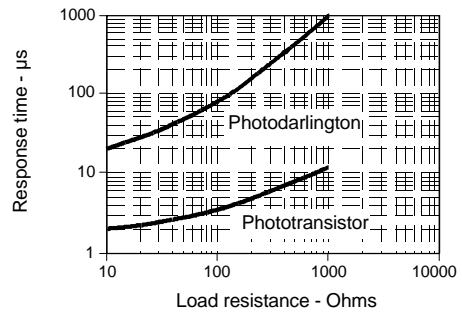

Fig. 3 Dark Current vs Temperature

gra_301.cdr

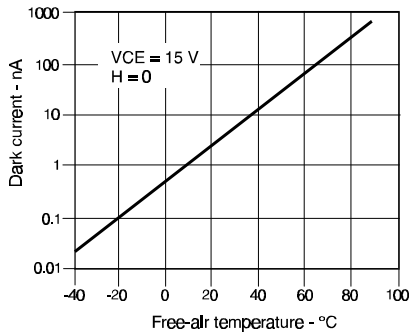

Fig. 4 Collector Current vs Ambient Temperature

gra_076.ds4

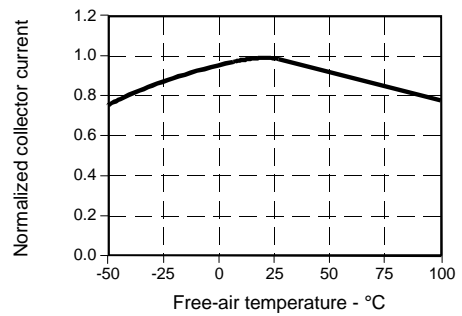

Fig. 5 Collector Current vs Distance to Reflective Surface

gra_086.ds4

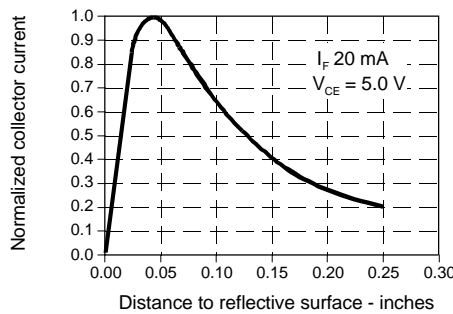
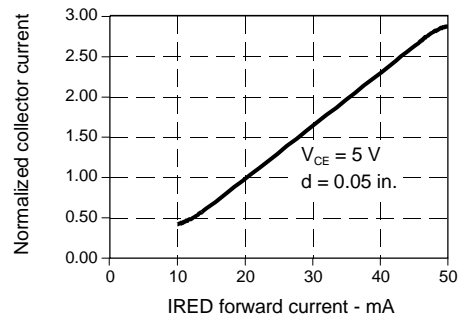

Fig. 6 Collector Current vs IRED Forward Current

gra_087.ds4



All Performance Curves Show Typical Values

HOA1397
Reflective Sensor



Honeywell reserves the right to make changes in order to improve design and supply the best products possible.

Honeywell