



The Future of Analog IC Technology®

MP2611

2A, 1-Cell Li-Ion Battery Switching Charger For USB and Adapter Power

DESCRIPTION

The MP2611 is a monolithic switching charger with built-in power MOSFETs for a single-cell Li-Ion battery pack. It achieves up to a 2A-charge current that can be programmed through an accurate sense resistor over the whole input range. It can operate from separate inputs for USB or AC adapter: For USB input, the input current limit can be programmed to 500mA and 900mA through the USBM pin to cover both USB2.0 and USB3.0 standards.

The MP2611 regulates the charge current and battery voltage using two control loops to realize highly accurate constant-current charge and constant-voltage charge. A 100% duty cycle can be achieved when battery voltage is close to the input voltage due to the high-side P-Channel MOSFET.

Battery charge temperature and charging status are always monitored for each condition. Two status-monitor output pins indicate the battery charging status and input status. The MP2611 also features internal reverse-blocking protection.

The MP2611 is available in a 3mm x 4mm QFN14 package.

FEATURES

- 4.5V-to-6V Operating Input Voltage
- Up to 100% Duty Operation.
- Up to 2A Programmable Charge Current
- ±0.5% Battery Voltage Accuracy
- Separate Inputs for USB and AC Adapter
- Fully-Integrated Power Switches
- Programmable Input Current Limit for the USB Port
- No External Reverse Blocking Diode Required
- Charging Operation Indicators
- Programmable Safety Timer
- Thermal Shutdown
- Cycle-by-Cycle Over Current Protection
- Battery Temperature Monitor and Protection

APPLICATIONS

- Smartphones
- Portable Hand-Held Solutions
- Portable Media Players

All MPS parts are lead-free and adhere to the RoHS directive. For MPS green status, please visit MPS website under Products, Quality Assurance page. "MPS" and "The Future of Analog IC Technology" are registered trademarks of Monolithic Power Systems, Inc.

TYPICAL APPLICATION

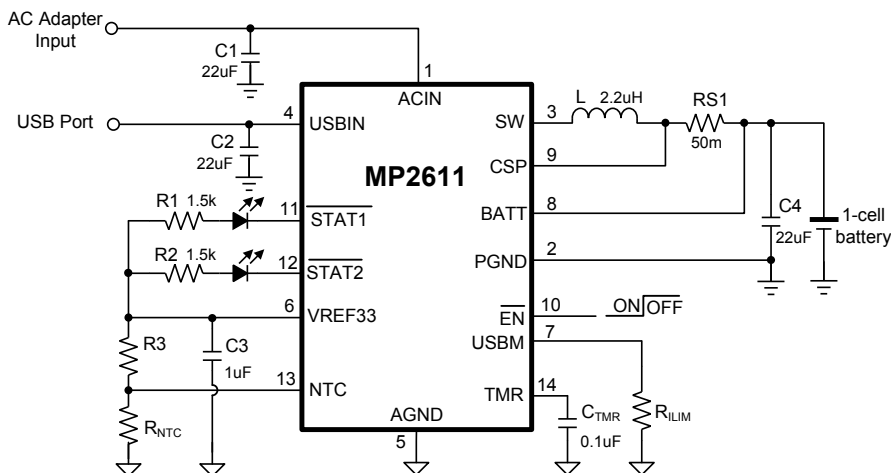

ORDERING INFORMATION

Part Number*	Package	Top Marking
MP2611GL	QFN14 (3x4mm)	2611

* For Tape & Reel, add suffix -Z (eg. MP2611GL-Z);

PACKAGE REFERENCE

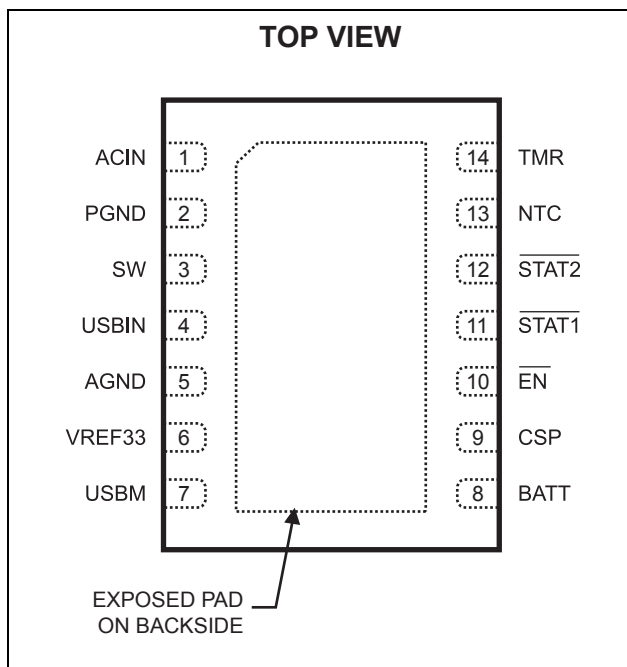

ABSOLUTE MAXIMUM RATINGS ⁽¹⁾

ACIN	7.5V
USBIN	7.5V
SW	-0.3V to (V _{IN} + 0.3V)
CSP, BATT	-0.3V to 6V
All the Other Pins	-0.3V to 6V
Continuous Power Dissipation (T _A =25°C) ⁽²⁾	2.6W
Junction Temperature	150°C
Lead Temperature	260°C
Storage Temperature	-65°C to 150°C

Recommended Operating Conditions ⁽³⁾

ACIN	4.5V to 6V
USBIN	4.5V to 6V
Operating Junction Temp. (T _J)	-40°C to +125°C

Thermal Resistance ⁽⁴⁾	θ_{JA}	θ_{JC}
QFN14 (3mm x 4mm)	48	10... °C/W

Notes:

- Exceeding these ratings may damage the device.
- The maximum allowable power dissipation is a function of the maximum junction temperature T_J (MAX), the junction-to-ambient thermal resistance θ_{JA} , and the ambient temperature T_A. The maximum allowable continuous power dissipation at any ambient temperature is calculated by P_D (MAX) = (T_J (MAX)-T_A)/ θ_{JA} . Exceeding the maximum allowable power dissipation will cause excessive die temperature, and the regulator will go into thermal shutdown. Internal thermal shutdown circuitry protects the device from permanent damage.
- The device is not guaranteed to function outside of its operating conditions.
- Measured on JESD51-7, 4-layer PCB.

ELECTRICAL CHARACTERISTICS

$V_{IN}^{(5)} = 5V$, $T_A = 25^\circ C$, Unless Otherwise Noted.

Parameters	Symbol	Condition	Min	Typ	Max	Units
AC Input						
ACIN Operating Range	V_{ACIN}		4.5	5	6	V
ACIN Under Voltage Lockout (UVLO) Rising Threshold	V_{UVLO}		3.55	3.75	3.95	V
ACIN Under Voltage Lockout (UVLO) Threshold Hysteresis				200		mV
Switching Frequency	f_s			1.5		MHz
Constant Charger Current	I_{CC}	RS1=50mΩ	1.8	2	2.2	A
High-side PFET On Resistance	$R_{H_DS(ON)}$			130		mΩ
Low-side NMOS On Resistance	$R_{L_DS(ON)}$			200		mΩ
High-side PFET Peak Current Limit			3	3.5		A
Dead Time				10		ns
Supply Current	I_{IN}	$\overline{EN} = 0V$, No load			2.0	mA
		$\overline{EN} = 4V$			20	μA
USB Input						
USBIN Operating Range	V_{USBIN}		4.5	5	6	V
USBIN Under Voltage Lockout (UVLO) Rising Threshold	V_{UVLO}		3.55	3.75	3.95	V
USBIN Under Voltage Lockout (UVLO) Threshold Hysteresis				200		mV
USB Input Current limit	I_{USB_LIM}	$R_{ILIM} = 82.5k\Omega$, $V_{USBIN} = 5V$, $V_{BATT} = 4V$		450	500	mA
		$R_{ILIM} = 45.3k\Omega$, $V_{USBIN} = 5V$, $V_{BATT} = 4V$		810	900	mA
High-side PFET On Resistance				110		mΩ
USB Supply Current		$\overline{EN} = 0V$, No load			2.0	mA
		$\overline{EN} = 4V$, No load			30	μA
Battery Charger						
Terminal Battery Voltage	V_{BATT_FULL}	$V_{IN} = 5V$	4.179	4.2	4.221	V
Battery Over-Voltage Threshold	V_{BOVP}	$V_{IN} = 5V$	4.26	4.34	4.42	V
Recharge Threshold at V_{BATT}	V_{RECHG}			4.0		V
Recharge Hysteresis				100		mV
Trickle-Charge Threshold	V_{TC}			3		V
Trickle-Charger Hysteresis				300		mV
Trickle-Charge Current	I_{TC}			10	15	% I_{CC}
Termination Charge Current	I_{BF}		5	10	15	% I_{CC}
Maximum Current-Sense Voltage (CSP to BATT)				100		mV
STAT1/STAT2 Open-Drain Sink Current		$V_{DRAIN} = 0.3V$		9		mA

ELECTRICAL CHARACTERISTICS (continued)
 $V_{IN}^{(5)} = 5V$, $T_A = 25^{\circ}C$, Unless Otherwise Noted.

Parameters	Symbol	Condition	Min	Typ	Max	Units
VIN Min Head-room (Reverse Blocking)		$V_{IN} - V_{BATT}$		200		mV
CSP, BATT Current	I_{CSP}, I_{BATT}	Charging Disabled			1	μA
Protection						
Trickle-Charge Time		$C_{TMR} = 0.1\mu F$		30		min
Total Charge Time		$C_{TMR} = 0.1\mu F$		180		min
NTC High Temp. Rising Threshold	V_{TH_High}	$R_{NTC} = NCP18XH103, 50^{\circ}C$	30	32	34	$\%V_{REF33}$
NTC Low Temp. Falling Threshold	V_{TH_Low}	$R_{NTC} = NCP18XH103, 0^{\circ}C$	72	74	76	$\%V_{REF33}$
Thermal Shutdown ⁽⁶⁾	T_{SHTDWN}			150		$^{\circ}C$
EN Logic						
\overline{EN} Input Low Voltage					0.8	V
\overline{EN} Input High Voltage			1.2			V
\overline{EN} Input Current		$\overline{EN} = 4V$		4		μA
		$\overline{EN} = 0V$		0.2		
VREF33 Output Voltage	V_{VREF33}		3.23	3.3	3.37	V
VREF33 Load Regulation	ΔV_{VREF33}	$I_{LOAD} = 0$ to 20mA		0.2		V

Notes:

 5) V_{IN} represents V_{ACIN} or V_{USBIN} which depends on the input mode. The following is the same.

6) Guaranteed by design..

TYPICAL CHARACTERISTICS

$V_{IN}=5V$, $C1=C2=22\mu F$, $C4=22\mu F$, $C_{TMR}=0.1\mu F$, $L=1.5\mu H$, $R_{S1}=50m\Omega$, $R_{LIM}=40.2k\Omega$, Battery Simulator, Unless Otherwise Noted.

BATT Voltage Accuracy vs. Temperature

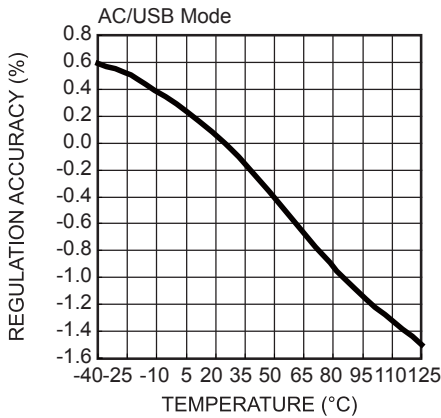

Charge Current Accuracy vs. Temperature

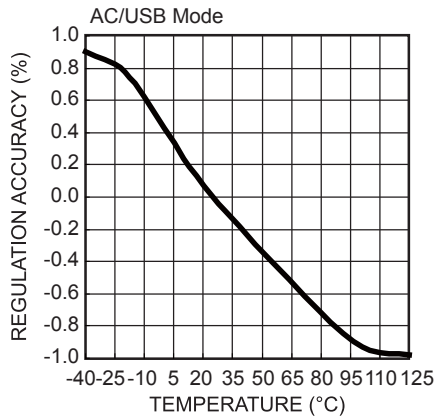

USB Current Limit Accuracy vs. Temperature

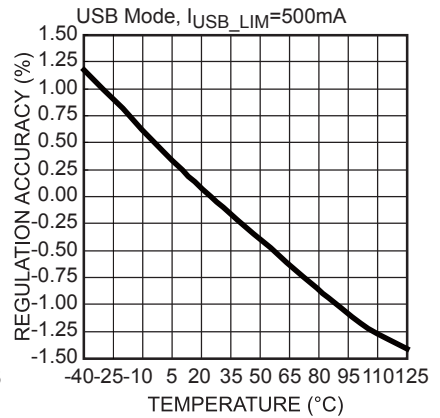

VREF Accuracy vs. Temperature

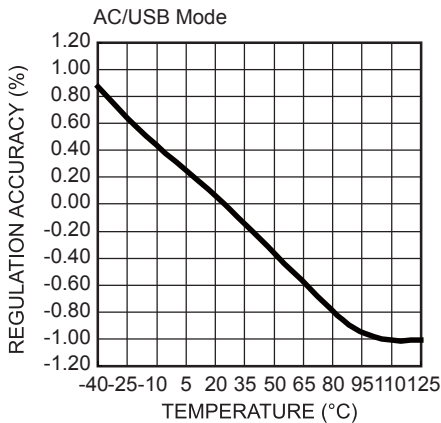

Quiescent Current vs. Temperature

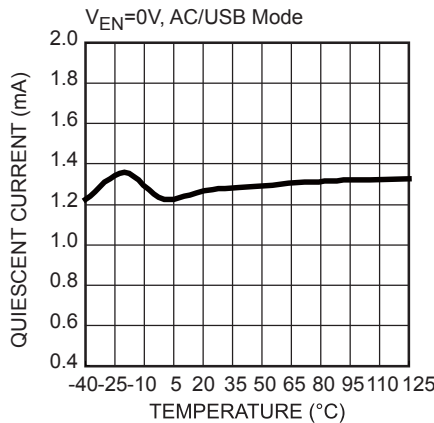

Shutdown Current vs. Temperature

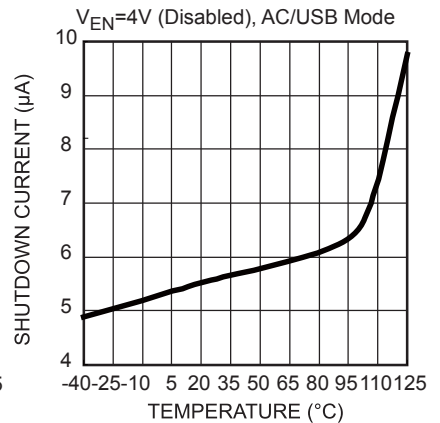

TYPICAL PERFORMANCE CHARACTERISTICS

$V_{IN}=5V$, $C1=C2=22\mu F$, $C4=22\mu F$, $C_{TMR}=0.1\mu F$, $L=1.5\mu H$, $R_{S1}=50m\Omega$, $R_{ILIM}=40.2k\Omega$, Battery Simulator, Unless Otherwise Noted.

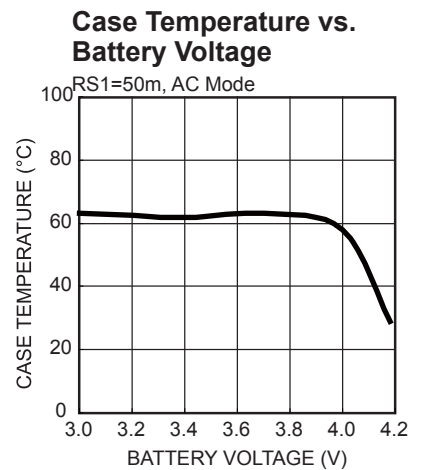
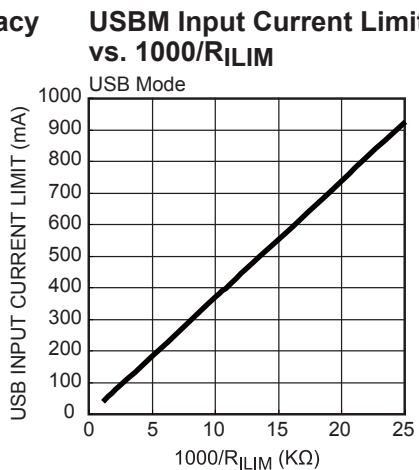
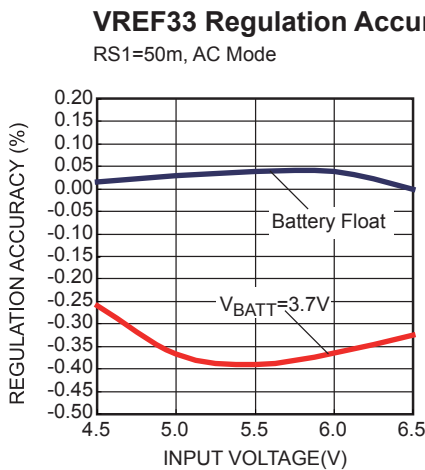
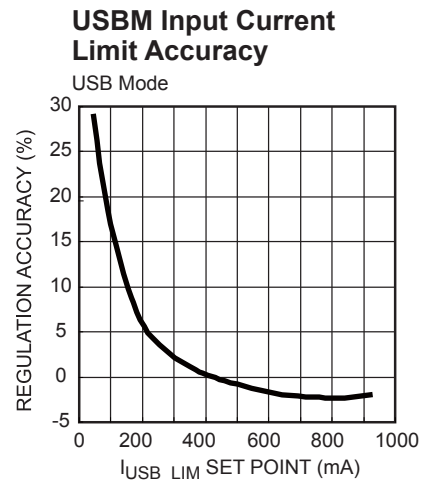
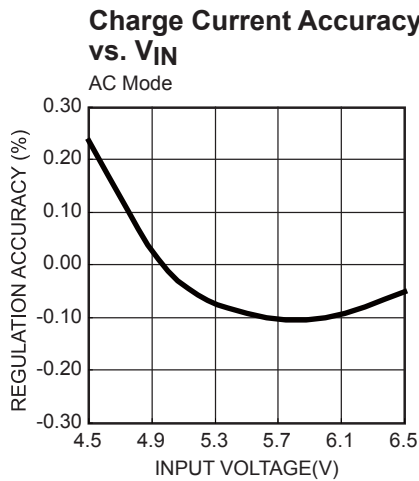
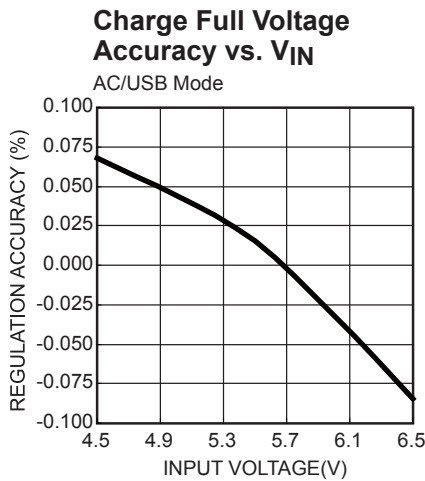
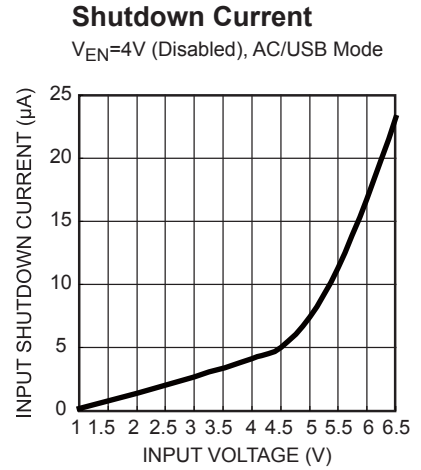
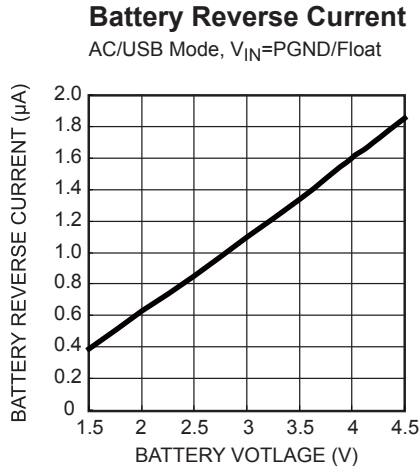
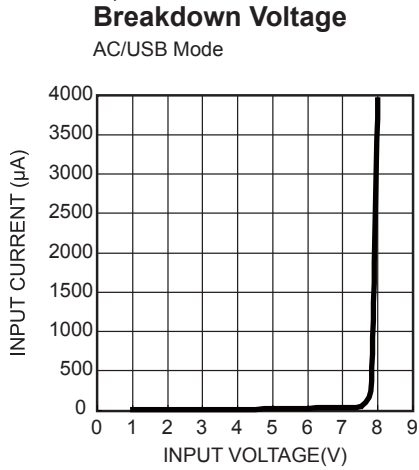

TYPICAL PERFORMANCE CHARACTERISTICS *(continued)*

$V_{IN}=5V$, $C1=C2=22\mu F$, $C4=22\mu F$, $C_{TMR}=0.1\mu F$, $L=1.5\mu H$, $R_{S1}=50m\Omega$, $R_{LIM}=40.2k\Omega$, Battery Simulator, Unless Otherwise Noted.

AC Mode Charge Curve

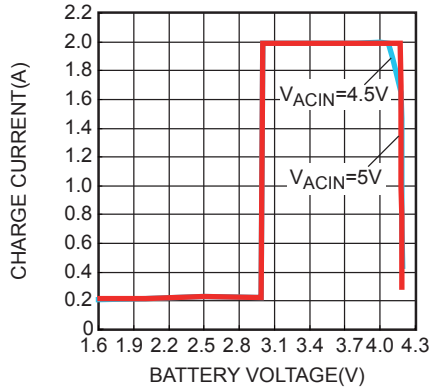

USB Mode Charge Curve

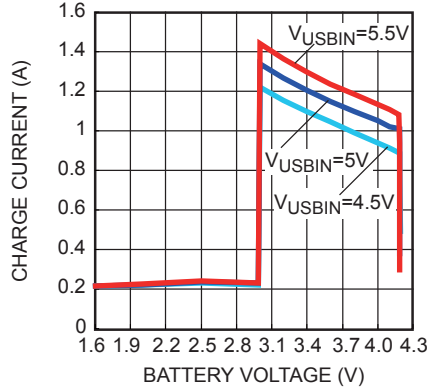

USB Mode Charge Curve

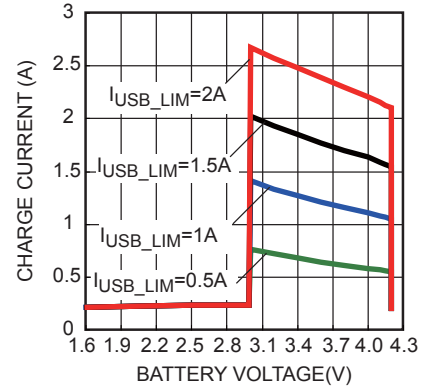

Frequency vs. Battery Voltage

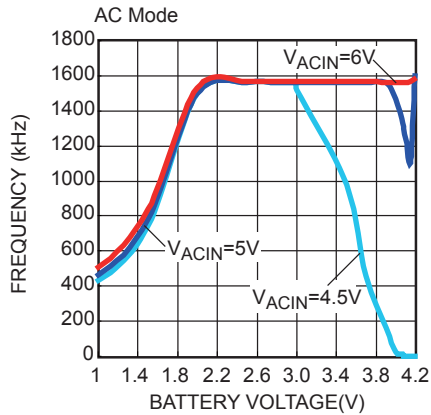

Frequency vs. Battery Voltage

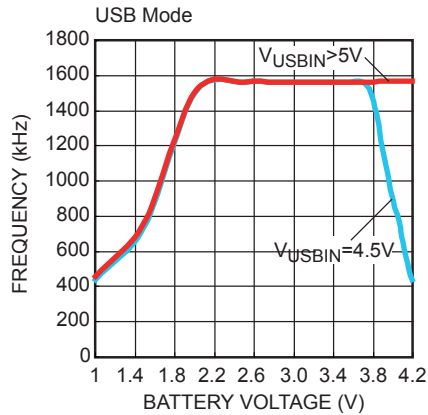

AC Mode Efficiency in TC/CC Charge

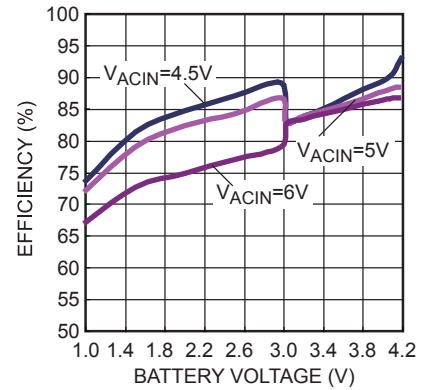

AC Mode Efficiency in CV Charge

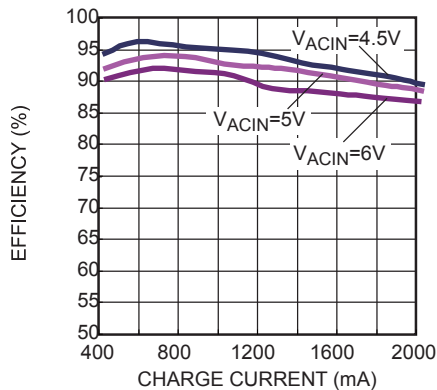

USB Mode Efficiency

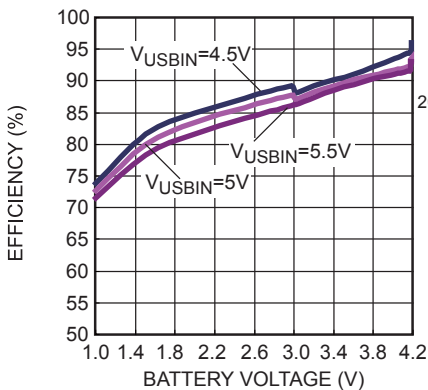

VREF Startup Waveform

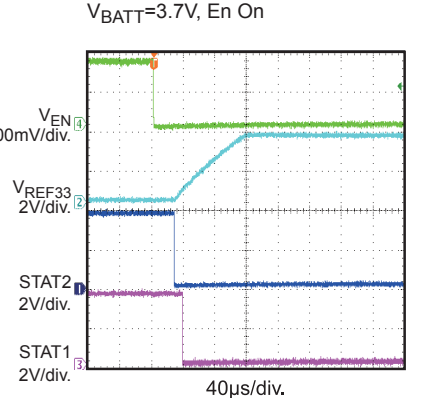

TYPICAL PERFORMANCE CHARACTERISTICS (continued)

$V_{IN}=5V$, $C1=C2=22\mu F$, $C4=22\mu F$, $C_{TMR}=0.1\mu F$, $L=1.5\mu H$, $R_{S1}=50m\Omega$, $R_{LIM}=40.2k\Omega$, Battery Simulator, Unless Otherwise Noted.

BATT Float Waveform
USB/AC Mode

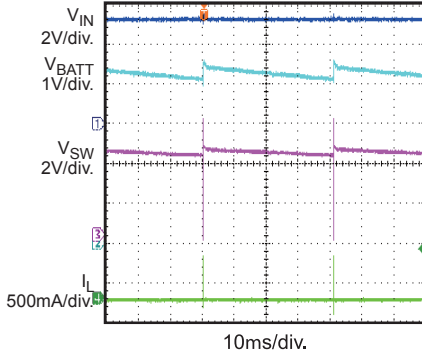

Low Input Voltage Charge State

AC Mode, $V_{ACIN}=4.5V$, $V_{BATT}=3.8V$

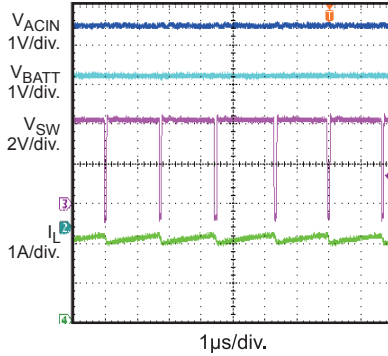

Low Input Voltage Charge State

AC Mode, $V_{ACIN}=4.5V$, $V_{BATT}=4V$

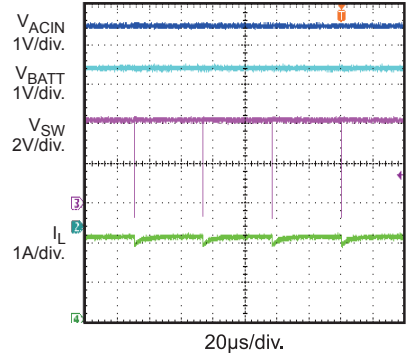

Low Input Voltage Charge State

AC Mode, $V_{ACIN}=4.5V$, $V_{BATT}=4.02V$

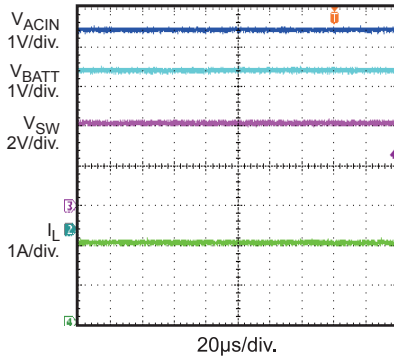

Low Input Voltage Charge State

AC Mode, $V_{ACIN}=4.5V$, $V_{BATT}=4.18V$

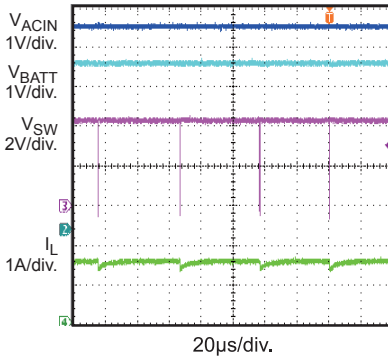

TC Charge Steady State

AC/USB Mode, $V_{BATT}=1.5V$

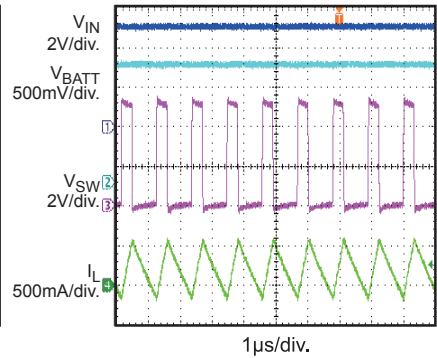

CC Charge Steady State

AC Mode, $V_{ACIN}=5V$, $V_{BATT}=3.8V$

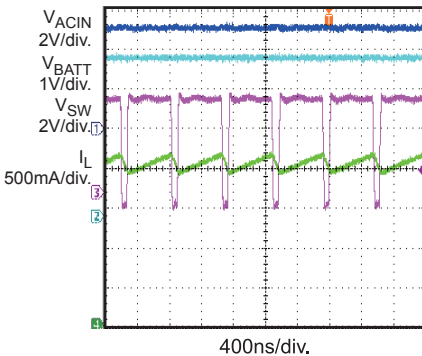

CC Charge Steady State

USB Mode, $V_{USBIN}=5V$, $V_{BATT}=3.8V$

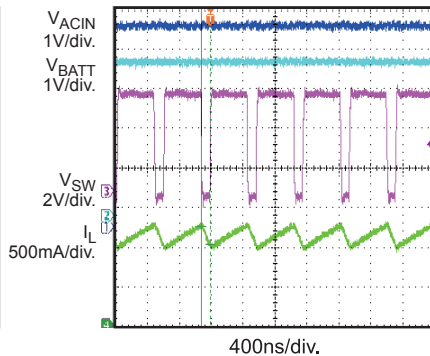

CV Charge Steady State

AC / USB Mode, $V_{BATT}=4.2V$

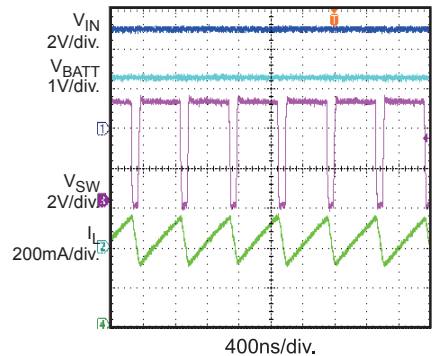

TYPICAL PERFORMANCE CHARACTERISTICS (continued)

$V_{IN}=5V$, $C1=C2=22\mu F$, $C4=22\mu F$, $C_{TMR}=0.1\mu F$, $L=1.5\mu H$, $R_{S1}=50m\Omega$, $R_{LIM}=40.2k\Omega$, Battery Simulator, Unless Otherwise Noted.

Power On
AC Mode, $V_{BATT}=3.8V$

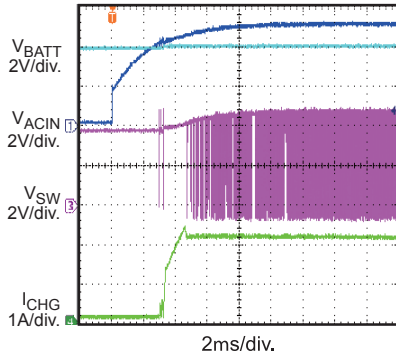

Power Off
AC Mode, $V_{BATT}=3.8V$

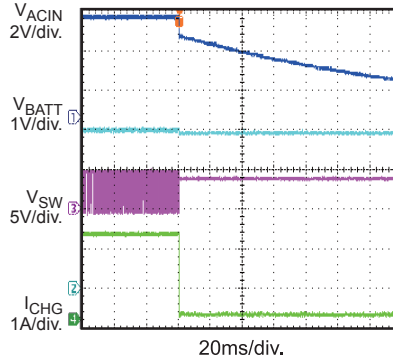

En On
AC Mode, $V_{BATT}=3.8V$

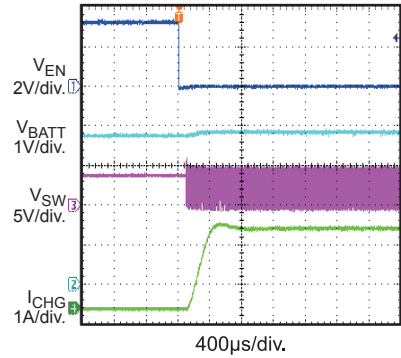

En Off
AC Mode, $V_{BATT}=3.8V$

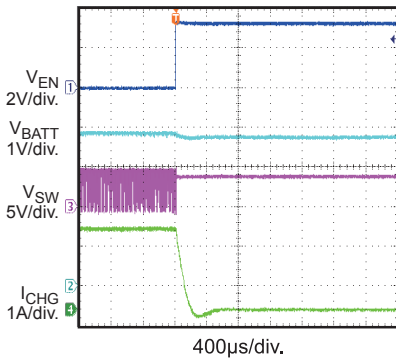

AC Adapter Insertion
 $V_{ACIN}=6V$, $V_{USBIN}=4.5V$, $V_{BATT}=4.1V$

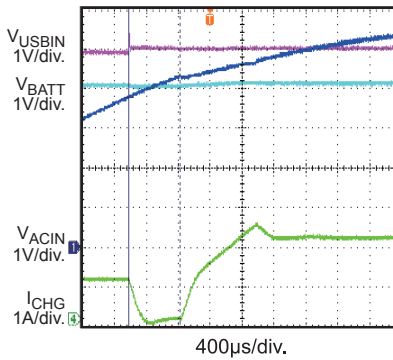

AC Adapter Removal
 $V_{ACIN}=6V$, $V_{USBIN}=4.5V$, $V_{BATT}=4.1V$

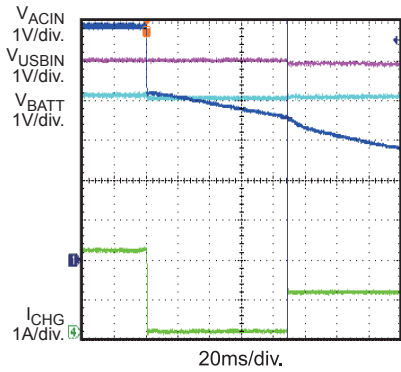

NTC Control
 $V_{BATT}=3.7V$

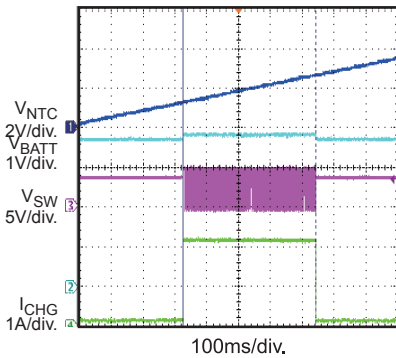

Timer Out
 $C_{TMR}=150pF$, $V_{BATT}=3.7V$

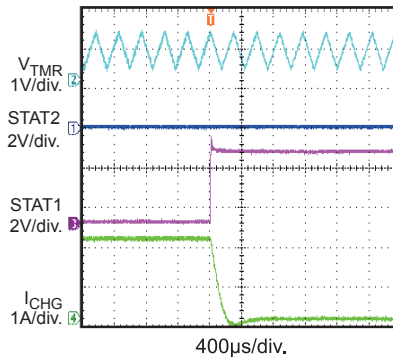

Short-Circuit Protection

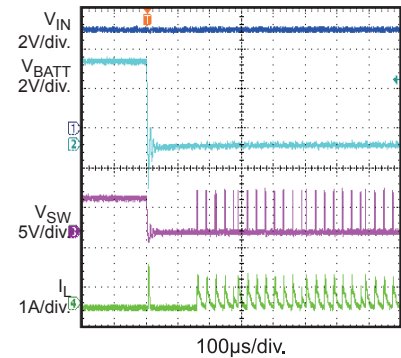

PIN FUNCTIONS

Package Pin #	Name	Description
1	ACIN	AC Adapter Power Input. Bypass ACIN to PGND with at least a 4.7 μ F ceramic capacitor when the pin is not applied for powering.
2	PGND	Power Ground. Voltage reference for the regulated output voltage: Take extra care with its layout. Place this node should be placed outside of the switching diode (SW-pin) to the input ground path to prevent switching current spikes from inducing voltage noise into the part.
3	SW	Switch Output. Connect to the switched side of the external inductor.
4	USBIN	USB Power Input. Bypass USBIN to PGND with at least a 4.7 μ F ceramic capacitor when the pin is not applied for powering.
5	AGND	Analog Ground.
6	VREF33	Internal Linear Regulator Reference Output. Powered from ACIN or USBIN.
7	USBM	USB Input Current-Limit Set. Connect a resistor from this pin to AGND to program the USB mode input current limit.
8	BATT	Positive Battery Terminal.
9	CSP	Battery Current Sense Positive Input. Connect resistor RS1 between CSP and BATT to sense the charge current.
10	$\overline{\text{EN}}$	On/Off Control Input.
11	$\overline{\text{STAT1}}$	Charging Status Indicator: 1. Charging; 2. End of charge; 3. Charging Suspended; 4. Fault; 5. Invalid Input Supply.
12	$\overline{\text{STAT2}}$	
13	NTC	Thermistor Input. Connect a resistor from this pin to the VREF33 and the thermistor from this pin to AGND.
14	TMR	Internal Safety Timer Control. Connect a capacitor from this node to AGND to set the timer. And the timer can be disabled by connecting this pin to AGND.

BLOCK DIAGRAM

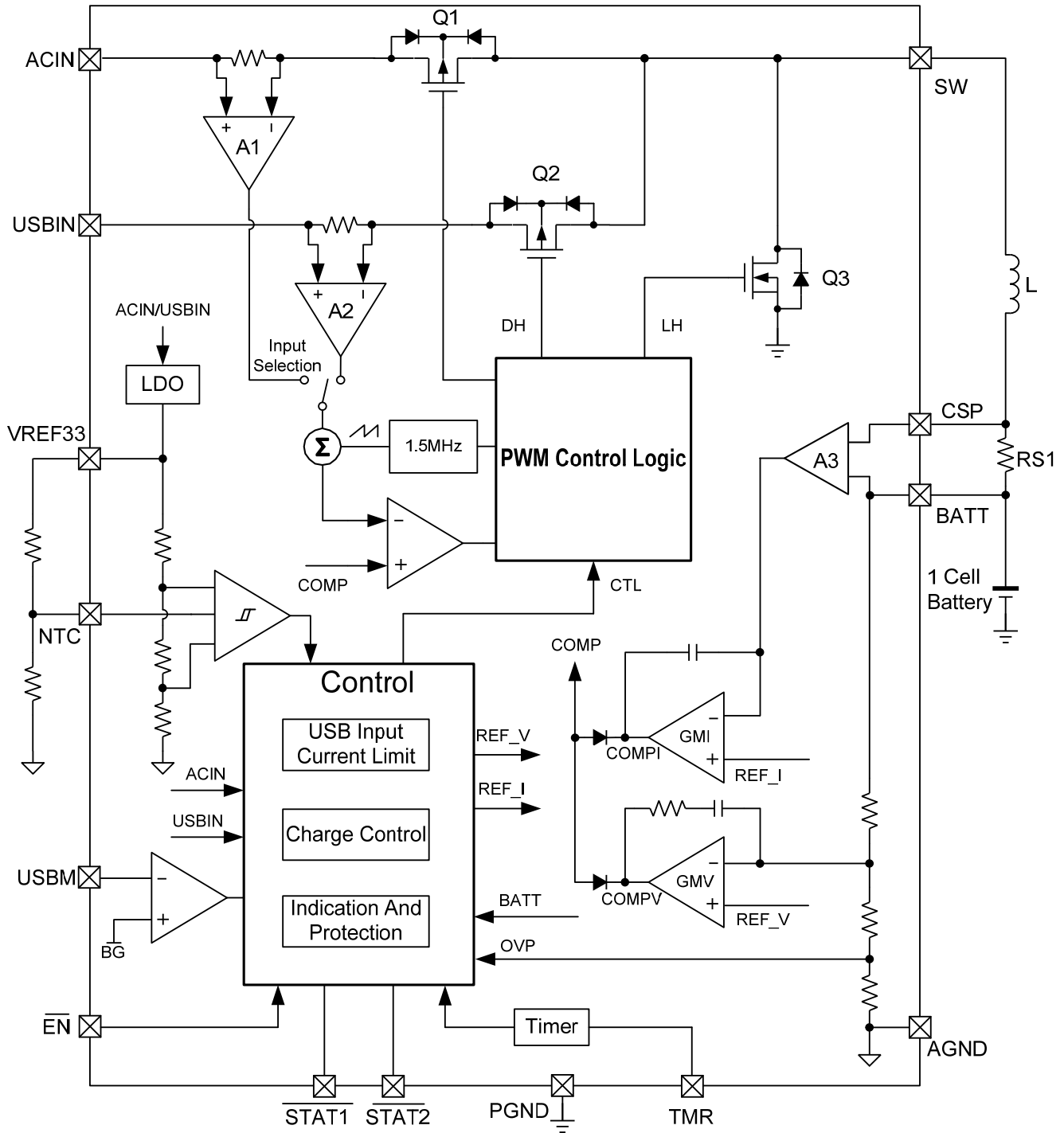

Figure 1: Functional Block Diagram

OPERATION

The MP2611 is a monolithic switching charger with built-in power MOSFETs for a single-cell Li-Ion battery pack. It achieves up to a 2A charge current that can be programmed through an accurate sense resistor over the whole input range. It can operate with separate inputs for USB and AC adapter: For USB mode, the input current limit can be programmed to 500mA and 900mA via the USBM-pin for both USB2.0 and USB3.0.

Charge Cycle (Trickle Charge → CC Charge → CV Charge)

The MP2611 regulates the charge current (I_{CHG}) and battery voltage (V_{BATT}) using two control loops to realize highly-accurate constant current (CC) charge and constant voltage (CV) charge.

The device uses the resistor RS1 to sense the battery charge current and amplifies the signal using the internal amplifier A3 (Figure 1). The charge starts in trickle-charge mode (TC, 10% of the constant current I_{CC}) until the battery voltage reaches 3V. If the charger stays in the trickle-charge mode until it triggers a time-out condition, the charging terminates. Otherwise, the charger operates in constant-current charging mode. The COMPI voltage, regulated by the amplifier GMI, determines the duty cycle.

When the battery voltage rises to the constant-voltage mode threshold, the amplifier GMV regulates the COMP-pin and the duty cycle. Consequently, the charger operates in constant-voltage mode.

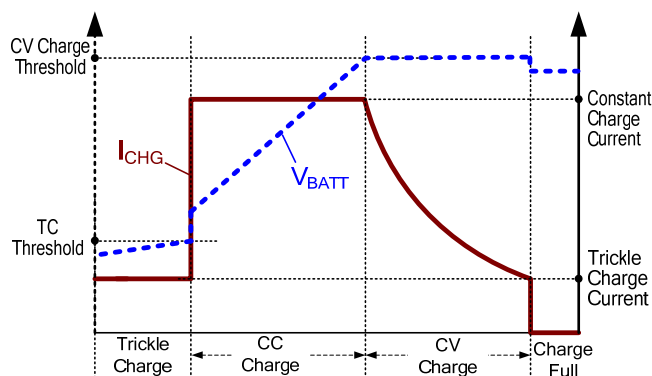

Figure 2: Li-Ion Battery Charge Profile

ACIN and USBIN Detection

There are two separate battery charger inputs; ACIN for the AC adapter, and USBIN for the USB port.

ACIN is used as the battery-charger primary power supply. As soon as the ACIN voltage exceeds ACIN UVLO (3.75V), Q1 turns on and Q2 turns off. The adapter charges the battery with up to 2A constant charge current through the step-down DC/DC converter implemented by Q1 and Q3. The charge current can be set by RS1.

If the ACIN input is absent or less than 3.75V, the USBIN can act as the power supply for the battery charger: Q1 turns off and Q2 turns on. USB supply mode uses the input current limit loop so that the threshold can be programmed by connecting a resistor R_{LIM} from the USBM-pin to AGND.

When ACIN and USBIN are both absent, Q1 and Q2 are completely off and the reverse blocking function blocks the battery reverse-leakage current to the input port.

Note that if ACIN and USBIN are both present, the device selects the AC adapter as the power supply of the charger. However, avoid this practice.

DC/DC Converter

The MP2611 integrates both the high-side switch and the synchronous low-side switch, which provides high efficiency and eliminates the external Schottky diode.

During normal operation, the high-side switch turns on for a period of time to ramp-up the inductor current at each rising edge of the internal oscillator, and switches off when the peak inductor current rises above the COMP voltage. Once the high-side switch turns off, the synchronous switch turns on immediately and stays on until the next cycle starts (see Figure 1).

The device allows the high-side switch to remain on for more than one switching cycle and increases the duty cycle while the input voltage drops close to the output voltage. When the duty cycle reaches 100%, the high-side switch is held on continuously to deliver current to the output.

Charge-Full Termination and Auto-Recharge

When the charge current drops below the termination threshold (I_{BF}) during the CV charge phase, the charger ceases charging and the $\overline{STAT1}$ -pin becomes an open drain. The timer will also be reset and turned off. If the battery voltage falls below 4.0V, auto-recharge begins and the timer restarts a new charge cycle.

Charger Status Indication

$\overline{STAT1}$ and $\overline{STAT2}$ are two open-drain NMOS outputs that must connect to the VREF33 output or some other bias power supply through pull-up resistors. Their output logic level combinations indicate three status of the charger:

Table 1: Charging Status Indicator

$\overline{STAT2}$	$\overline{STAT1}$	Charger Status
Low	Low	Charging
Low	High	End of Charge; Faults (Thermal Shutdown; Time-Out; NTC Fault)
High	High	Input Power Absent; $V_{IN}-V_{BATT}<0.2V$; \overline{EN} Disabled

Safety Timer Operation

The MP2611 adopts an internal timer to terminate charging if the timer times out. An external capacitor on the TMR-pin programs the timer duration.

The trickle mode charge time is:

$$t_{\text{Trickle_tmr}} = 30 \times \frac{C_{\text{TMR}}}{0.1\mu\text{F}} \text{ (minutes)}$$

The total charge time is:

$$t_{\text{Total_tmr}} = 3 \times \frac{C_{\text{TMR}}}{0.1\mu\text{F}} \text{ (hours)}$$

Where C_{TMR} is the capacitor connected from TMR-pin to GND. The timer can be disabled by pulling TMR to GND.

If a timer-out event occurs, the charging will be terminated and the $\overline{STAT1}$ will become an open drain to indicate the fault.

The charger can exit the timer-out fault state and initiates a new charge cycle when one of the following conditions occurs:

- The battery voltage falls below the auto-recharge threshold V_{RECHG} ;
- A power-on-reset (POR) event occurs;
- \overline{EN} is toggled.

Negative Thermal Coefficient (NTC) Thermistor

The MP2611 has a built-in NTC window comparator that allows it to sense the battery temperature via the thermistor packed internally in the battery. It ensures a safe battery operating environment. Connect an appropriately-valued resistor from VREF33 to the NTC-pin and connect the thermistor from the NTC-pin to AGND. The resistor divider with a dividing ratio depends on the battery temperature determines the voltage on the NTC-pin. Once the voltage at the NTC-pin is out of the NTC window, the MP2611 stops charging. The charger restarts if the voltage re-enters the NTC window range.

Short Circuit Protection

The MP2611 has an internal comparator to check for battery short circuit. Once V_{BATT} falls below 2V, the device detects a battery-short status and the cycle-by-cycle peak current limit falls to about 2A to limit the current spike during the battery-short transition. Furthermore, the switching frequency also folds back to minimize the power loss.

Thermal Shutdown Protection

To prevent the chip from overheating during charging, the MP2611 monitors the junction temperature, T_J , of the die. Once T_J reaches the thermal shutdown threshold (T_{SHUTDOWN}) of 150°C, the charger converter turns off. Charging restarts when T_J falls below 130°C.

BATTERY CHARGE TIMING DIAGRAM

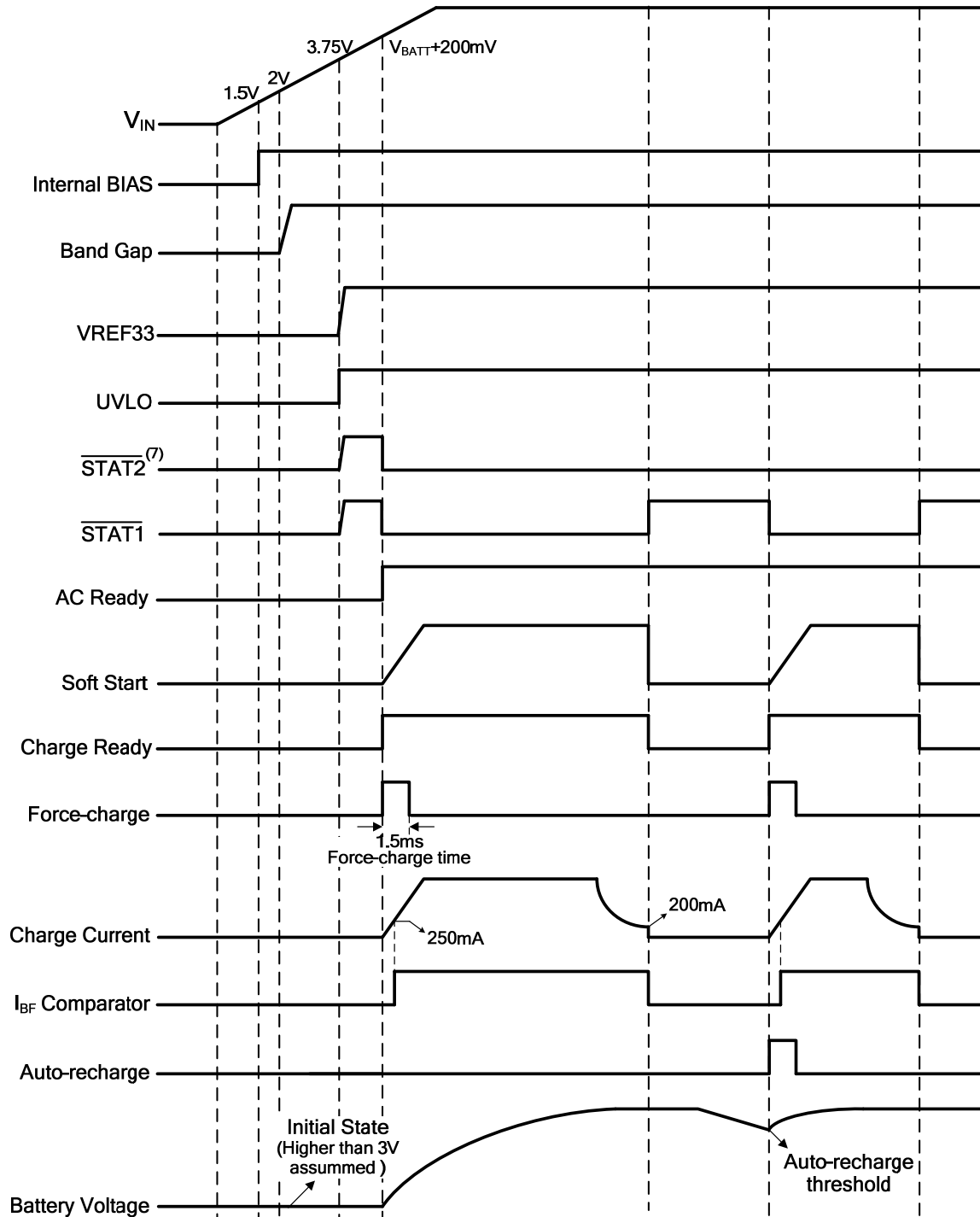

Figure 3: Battery Charge Timing Diagram

Note:

7) The $\overline{STAT1}$ and $\overline{STAT2}$ are pulled up to V_{REF33} with a 1k Ω resistor respectively.

OPERATION FLOW CHART

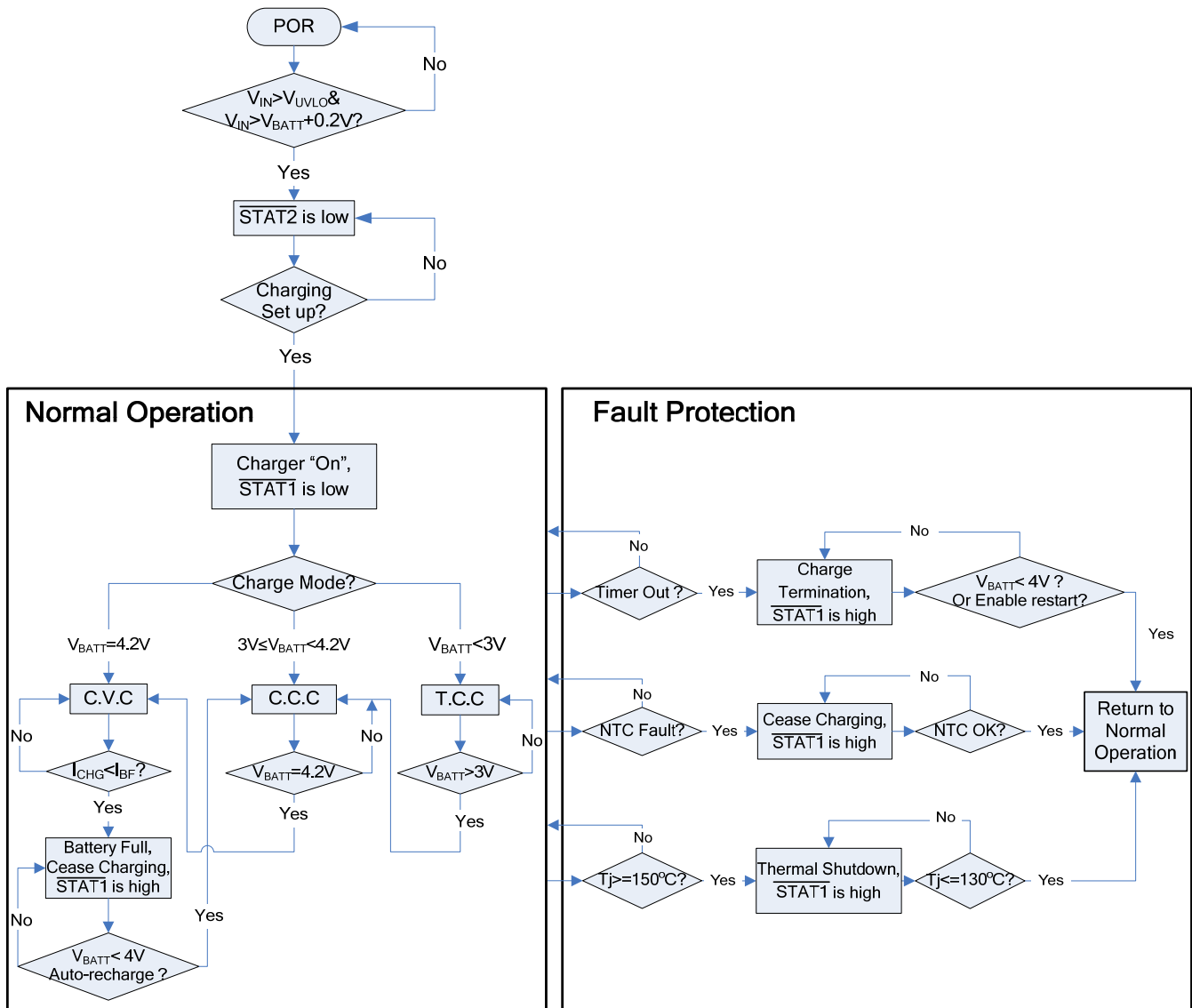

Figure 4: Normal Charging Operation and Fault Protection Flow Chart

APPLICATION INFORMATION

Setting the Charge Current in AC Mode

In AC mode, RS1 sets the charge current (I_{CHG}) of the MP2611 (see Typical Application). The equation to determine the programmable CC-charge is as follows:

$$I_{CC} = \frac{100\text{mV}}{RS1(\text{m}\Omega)} \text{ (A)} \quad (1)$$

Assume $I_{CC}=2\text{A}$, thus: $RS1=50\text{m}\Omega$.

For either AC mode or USB mode, the trickle charge current is given by the following equation:

$$I_{TC} = 10\%I_{CC} = \frac{10\text{mV}}{RS1(\text{m}\Omega)} \text{ (A)} \quad (2)$$

Setting the USB Input Current Limit

In USB supply mode, connect a resistor from the USBM pin to AGND to program the input current limit for different USB ports. The relationship between the input current limit and setting resistor is as following:

$$I_{USB_LIM} = \frac{37000}{R_{ILIM}(\text{k}\Omega)} \text{ (mA)} \quad (3)$$

Where R_{ILIM} is greater than $18.5\text{k}\Omega$ so that I_{USB_LIM} is in the range of 0A to 2A . If using a resistor smaller than $18.5\text{k}\Omega$, the MP2611 suppresses I_{USB_LIM} to a value less than 2A . For most applications, use a $45.3\text{k}\Omega$ R_{ILIM} ($I_{USB_LIM}=900\text{mA}$) for USB3.0 mode, and use a $82.5\text{k}\Omega$ R_{ILIM} ($I_{USB_LIM}=500\text{mA}$) for USB2.0 mode.

Note that in USB mode, the MP2611 doesn't monitor the charge current through RS1 during CC charge phase, but regulates the input current constant at the limitation value I_{USB_LIM} . Thus the CC charge current varies with different input and battery voltages. Figure 5 shows the charge current vs. battery voltage curve when $V_{USBIN}=5.5\text{V}$.

The maximum CC charge value can be calculated as:

$$I_{CC_MAX} = \frac{V_{USBIN} \cdot I_{USB_LIM} \cdot \eta}{V_{TC}} \text{ (A)} \quad (4)$$

Where V_{TC} is trickle charge threshold (3V) and η is the current charge efficiency. Assume $V_{USBIN}=5.5\text{V}$, $I_{USB_LIM}=1.5\text{A}$, $\eta=83\%$, thus $I_{CC_MAX}=2.28\text{A}$.

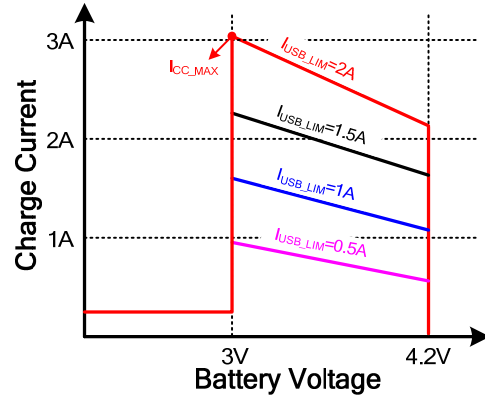

Figure 5: I_{CHG} Variation with $V_{USBIN}=5.5\text{V}$

For certain battery packs, the CC charge current should never go too high so set the I_{USB_LIM} based on the I_{CC_MAX} .

Selecting the Inductor

Inductor selection trades off between cost, size, and efficiency. A lower inductance value corresponds with smaller size, but results in higher ripple currents, higher magnetic hysteric losses, and higher output capacitances. However, a higher inductance value benefits from lower ripple current and smaller output filter capacitors, but results in higher inductor DC resistance (DCR) loss. From a practical standpoint, the inductor ripple current does not exceed 15% of the maximum charge current under worst cases. For a MP2611 with a typical 5V input voltage, the maximum inductor current ripple occurs at the corner point between trickle charge and CC charge ($V_{BATT}=3\text{V}$). Estimate the required inductance as:

$$L = \frac{V_{IN} - V_{BATT}}{\Delta I_{L_MAX}} \cdot \frac{V_{BATT}}{V_{IN} \cdot f_S} \quad (5)$$

Where V_{IN} , V_{BATT} , and f_S are the typical input voltage, the CC charge threshold, and the switching frequency, respectively. ΔI_{L_MAX} is the maximum inductor ripple current, which is usually 15% of the CC charge current.

$$\Delta I_{L_MAX} = 15\% I_{CC} \quad (6)$$

For $I_{CC}=2A$, $V_{IN}=5V$, $V_{BATT}=3V$ and $f_s=1.5MHz$, the calculated inductance is $2.66\mu H$. The maximum inductor peak current must exceed $2.3A$. To optimize efficiency, chose an inductor with a DC resistance less than $50m\Omega$. Choose the inductor 7447745022 from Wurth Corporation with ratings at $L=2.2\mu H/3.5A/36m\Omega$.

NTC Function

Figure 6 shows that an internal resistor divider sets the low temperature threshold and high temperature threshold at $74\% \cdot V_{REF33}$ and $32\% \cdot V_{REF33}$, respectively. For a given NTC thermistor, select appropriate R_{T1} and R_{T2} to set the NTC window.

The thermistor (NCP18XH103) noted above has the following electrical characteristic:

At $0^\circ C$, $R_{NTC_Cold} = 27.445k\Omega$;

At $50^\circ C$, $R_{NTC_Hot} = 4.1601k\Omega$.

The following equations are derived assuming that the NTC window is between $0^\circ C$ and $50^\circ C$:

$$\frac{R_{T2} // R_{NTC_Cold}}{R_{T1} + R_{T2} // R_{NTC_Cold}} = \frac{V_{TH_Low}}{V_{REF33}} = 74\% \quad (7)$$

$$\frac{R_{T2} // R_{NTC_Hot}}{R_{T1} + R_{T2} // R_{NTC_Hot}} = \frac{V_{TH_High}}{V_{REF33}} = 32\% \quad (8)$$

According to equation (7) and equation (8), $R_{T1} = 8.7k\Omega$ and $R_{T2} = 252.3k\Omega$. Simplified for applications, $R_{T1} = 8.7k\Omega$ and $R_{T2} = \text{No Connect}$ approximates the values.

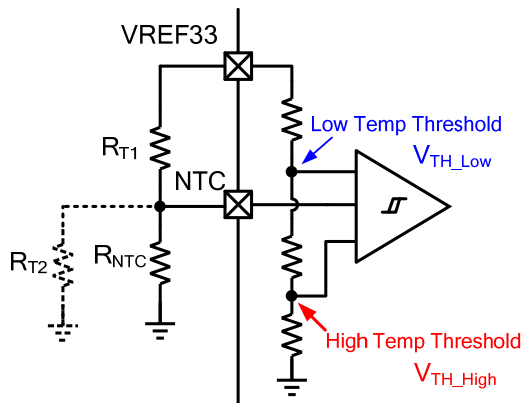

Figure 6: NTC Function Block

Selecting the Input Capacitor

The input capacitors C1/C2 from the typical application circuit absorbs the maximum ripple current from the buck converter, which is given by:

$$I_{RMS_MAX} = I_{CC_MAX} \frac{\sqrt{V_{TC}(V_{IN_MAX} - V_{TC})}}{V_{IN_MAX}} \quad (9)$$

For $I_{CC_MAX}=2A$, $V_{TC}=3V$, $V_{IN_MAX}=6V$, the maximum ripple current is $1A$. Select the input capacitors so that the temperature rise due to the ripple current does not exceed $10^\circ C$. Use ceramic capacitors with X5R or X7R dielectrics because of their low ESR and small temperature coefficients. For most applications, use a $22\mu F$ capacitor.

Selecting the Output Capacitor

The output capacitor—C4 from the typical application circuit—is in parallel with the battery. C4 absorbs the high-frequency switching ripple current and smoothes the output voltage. Its impedance must be much less than that of the battery to ensure it absorbs the ripple current. Use a ceramic capacitor because it has lower ESR and smaller size that allows us to ignore the ESR of the output capacitor. Thus, the output voltage ripple is given by:

$$\Delta r_o = \frac{\Delta V_o}{V_o} = \frac{1 - \frac{V_o}{V_{IN}}}{8C_o f_s^2 L} \quad (10)$$

In order to guarantee the $\pm 0.5\%$ battery voltage accuracy, the maximum output voltage ripple must not exceed 0.5% (e.g. 0.1%). The maximum output voltage ripple occurs at the minimum battery voltage of the CC charge and the maximum input voltage.

For $V_{IN_MAX}=6V$, $V_{CC_MIN}=V_{TC}=3V$, $L=1.5\mu H$, $f_s=1.5MHz$, $\Delta r_{o_MAX} = 0.1\%$, the output capacitor can be calculated as:

$$C_o = \frac{1 - \frac{V_{TC}}{V_{IN_MAX}}}{8f_s^2 L \Delta r_{o_MAX}} = 18.5\mu F \quad (11)$$

We can then choose a $22\mu F$ ceramic capacitor.

PCB Layout Guide

PCB layout is important to meet specified noise, efficiency and stability requirements. The following design considerations can improve circuit performance:

- 1) Route the power stage adjacent to their grounds. Aim to minimize the high-side switching node (SW, inductor), trace lengths in the high-current paths and the current-sense resistor trace. Keep the switching node short and away from the feedback network.
- 2) The exposed thermal pad on the backside of the MP2611 package must be soldered to the PGND plane. There must be sufficient thermal vias underneath the IC connected to the ground plane on the other layers.
- 3) Connect the charge current sense resistor to CSP (pin 9), BATT (pin 8) with a Kelvin contact. Minimize the length and area of this circuit loop.
- 4) Place the input capacitor as close as possible to the ACIN/USBIN and PGND pins. Place the output inductor close to the IC and connect the output capacitor between the inductor and PGND of the IC. This minimizes the current path loop area from the SW pin through the LC filter and back to the PGND pin.
- 5) Connect AGND and PGND at a single point.

Single Input Port Application

For some portable devices, only one input port that covers both AC adapter and USB port is adopted. The charger is then required to identify the input source (AC adapter or USB port) via an external logic signal from MODE-pin. MODE-pin pulled high indicates an AC adapter is connected, low indicates an USB port source.

Figure 9 shows a single input port application circuit. The MOSFET M1 is used to alter the input source. High-level voltage at MODE-pin turns on the M1 and the charger is then switched from USB input mode to AC input mode. The capacitor C5 and R5 are necessary to realize the soft-start of voltage at ACIN, increase the value if the recommended value in Figure 9 does not work.

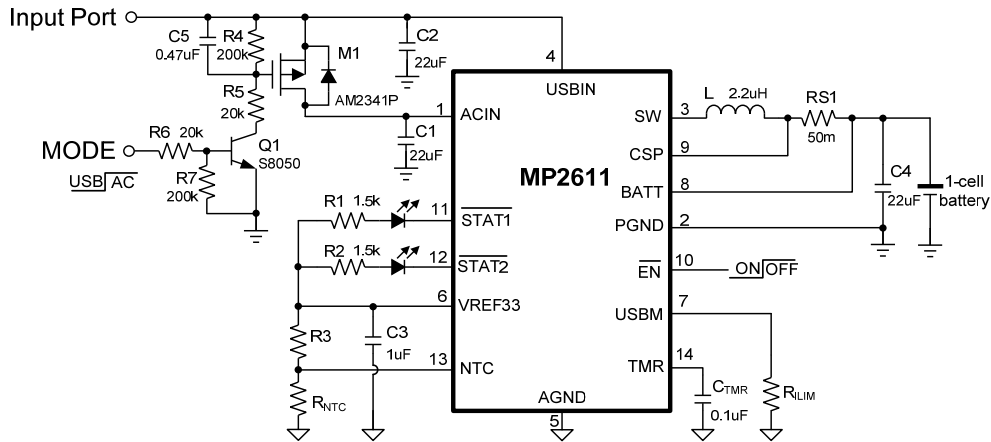

Figure 9: Single Input Port Application Circuit –1

Figure 10 shows another single input port application circuit. For the AC adapter input, the high-level signal at MODE-pin turns on the M1 to connect the parallel resistor R4 at USBM-pin. Due to the increased input current limitation, charge current is enlarged. Please refer to the

USB input current setting and choose the appropriate resistor based on the actual battery specification. R8 and C5 are necessary for soft tuning on and off of M1 to avoid unexpected USBM reference caused by noise.

In addition, a least 4.7μF ceramic capacitor connected between ACIN-pin to PGND is necessary to avoid noise interference.

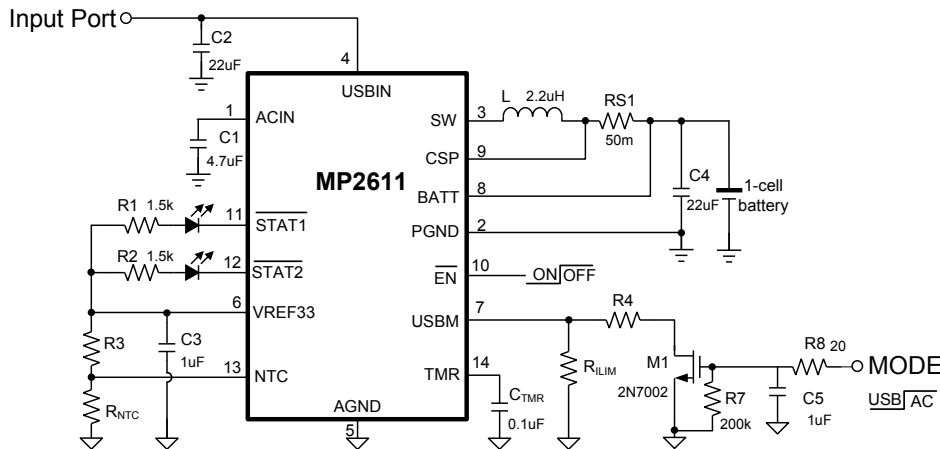

Figure 10: Single Input Port Application Circuit –2

Input OVP Application

For MP2611, the maximum rating of input voltage is only 7.5V. In order to prevent an unmatched adapter from being connected to damage this part, the input over-voltage protection (OVP) is required. Figure 11 shows the application circuit

for the input OVP, where the OVP threshold can be programmed via the resistor divider consist of R4 and R5. For the given parameters below, the OVP threshold is 6.2V and maximum input rating is extended to 18V (Limited by the TLVH431).

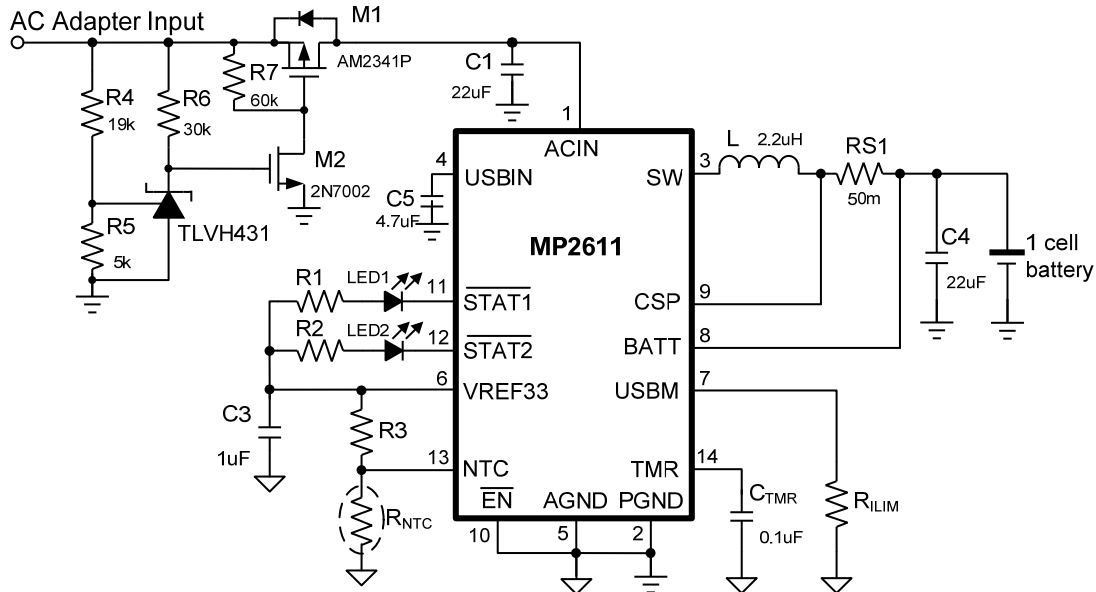
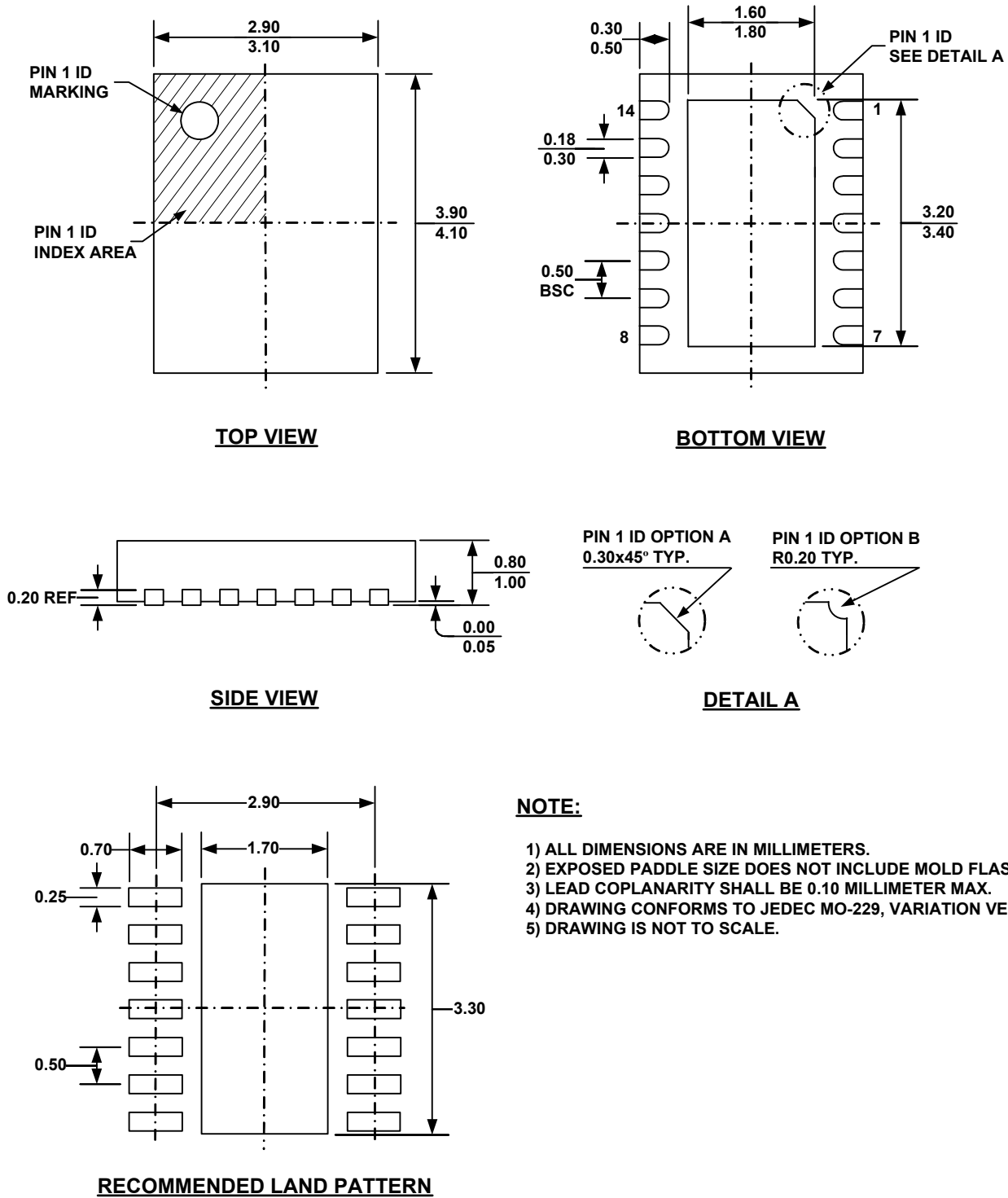

Figure 11: AC Input Mode with Input OVP

PACKAGE INFORMATION

QFN 14 (3mm x 4mm)



NOTICE: The information in this document is subject to change without notice. Please contact MPS for current specifications. Users should warrant and guarantee that third party Intellectual Property rights are not infringed upon when integrating MPS products into any application. MPS will not assume any legal responsibility for any said applications.