

THIS COPY IS PROVIDED ON A RESTRICTED BASIS AND IS NOT TO BE USED IN ANY WAY DETRIMENTAL TO THE INTERESTS OF PANDUIT CORP.

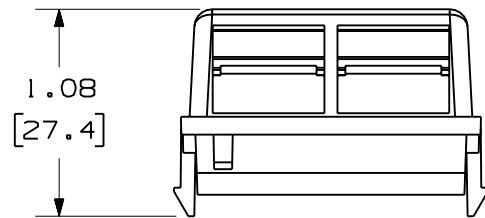
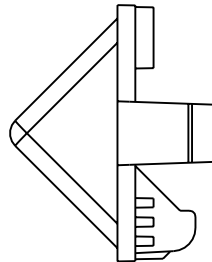
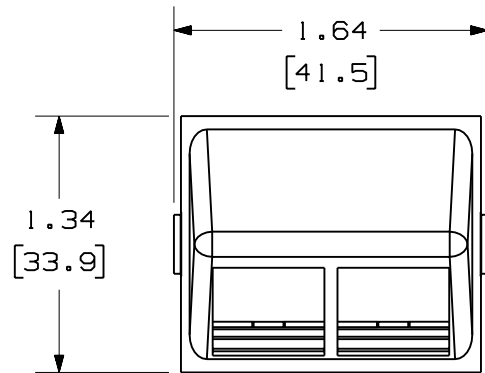

PANDUIT P/N	WEIGHT
NKHS2**-X	.06 LB/10 PCS (29.1 g/10 PCS)

NOTES:

1. SEE CURRENT CATALOG FOR ADDITIONAL PART NUMBER SUFFIXES TO INDICATE COLOR AND OR PACKAGE QUANTITY.
2. SEE CATALOG FOR COMPLETE LIST OF PARTS APPLICABLE FOR USE WITH THIS PART.
3. DIMENSIONS IN PARENTHESES ARE IN METRIC.

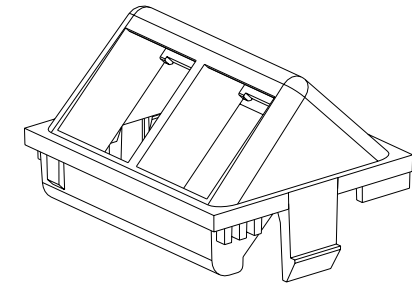

MODEL FILENAME	MO2201BC_NKHS2_00.PRT	SIZE A
DRAWING FILENAME	MO2201BC_DC_00A.PRT	

NETKEY™ 2 POSITION SLOPED INSERT
CUSTOMER DRAWING

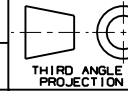
 PANDUIT ™ CORP. TINLEY PARK, ILL 60477	I.I. NUMBER	N/A
	PRODUCT SPEC	N/A
 THIRD ANGLE PROJECTION ALL DIMENSIONS ARE GIVEN IN INCHES, UNLESS OTHERWISE SPECIFIED. DIMENSIONAL TOLERANCES ARE: (.X) ± (.XXX) ± .010(.3) (.XX) ± .03(.8) ANGLES ±	WORK INSTRUCTION	N/A
	SCALE	NONE
DRAWN BY JsP	PART NO.	NKHS2**-X
DATE 3-30-05	MATERIAL: ABS	DRAWING NO. 02201-06
CHK'D		

REV	DATE	BY	CHK	DESCRIPTION	ECN	R	CUST	SUP	OTH
R	3-30-05	JsP		RELEASED TO PRODUCTION	02201-06				