

ISL6422B

Dual Output LNB Supply and Control Voltage Regulator with I²C Interface for Advanced Satellite Set-Top Box Designs

FN6486
Rev 2.00
Sep 8, 2015

The ISL6422B is a highly integrated voltage regulator and interface IC, specifically designed for supplying power and control signals from advanced satellite set-top box (STB) modules to the low noise blocks (LNBs) of two antenna ports. The device consists of two independent current-mode boost PWMs and two low-noise linear regulators along with the circuitry required for 22kHz tone generation, modulation and I²C device interface. The device makes the total LNB supply design simple, efficient and compact with low external component count.

Two independent current-mode boost converters provide the linear regulators with input voltages that are set to the final output voltages, plus typically 0.8V to insure minimum power dissipation across each linear regulator. This maintains constant voltage drops across each linear pass element while permitting adequate voltage range for tone injection.

The final regulated output voltages are available at two output terminals to support simultaneous operation of two antenna ports for dual tuners. The outputs for each PWM can be controlled in two ways, full control from I²C using the VTOP1, VTOP2 and VBOT1, VBOT2 bits or set the I²C to the lower range ie 13V/14V and switch to higher range ie 18V/19V with the SELVTOP1, SELVTOP2 pins. All the functions on this IC are controlled via the I²C bus by writing 8 bits words onto the System Registers (SR). The same register can be read back, and four bits per output will report the diagnostic status. Separate enable commands sent on the I²C bus provide independent standby mode control for each PWM and linear combination, disabling the output into shutdown mode. Each output channel is capable of providing 750mA of continuous current. The overcurrent limit can be digitally programmed.

The External modulation input EXTM1, EXTM2 can accept a modulated DiSEqC command and transfer it symmetrically to the output. Alternatively the EXTM1, EXTM2 pins can be used to modulate the continuous internal tone.

The $\overline{\text{FLT}}$ pin serves as an interrupt for the processor when any condition turns OFF the LNB controller (Over-Temperature, Overcurrent, Disable). The nature of the fault can be read of the I²C registers.

Features

- Single Chip Power Solution
 - True Dual Operation for 2-Tuner/2-Dish Applications
 - Both Outputs May be Enabled Simultaneously at Maximum Power
 - Integrated DC/DC Converter and I²C Interface
- Switch-Mode Power Converter for Lowest Dissipation
 - Boost PWMs with >92% Efficiency
 - Selectable 13.3V or 18.3V Outputs
 - Digital Cable Length Compensation (1V)
 - I²C and Pin Controllable Output
- Output Back Bias Capability of 28V
- I²C Compatible Interface for Remote Device Control
- Four level Slave Address 0001 00XX
- 2.5V/3.3V/5V Logic Compatible
- External Pins to Toggle Between V and H Polarization
- Built-In Tone Oscillator Factory Trimmed to 22kHz
 - Facilitates DiSEqC (EUTELSAT) Encoding
 - External Modulation Input
- Internal Over-Temperature Protection and Diagnostics
- Internal OV, UV, Overload and Overtemp Flags (Visible on I²C)
- $\overline{\text{FLT}}$ Signal
- LNB Short-Circuit Protection and Diagnostics
- QFN and EPTSSOP Packages
- Pb-Free Plus Anneal Available (RoHS Compliant)

Applications

- LNB Power Supply and Control for Satellite Set-Top Box

Ordering Information

PART NUMBER (Note)	PART MARKING	TEMP. RANGE (°C)	PACKAGE (Pb-Free)	PKG. DWG. #
ISL6422BERZ*	6422B ERZ	-20 to +85	40 Ld 6x6 QFN	L40.6x6
ISL6422BEVEZ* (No longer available, Recommended Replacement ISL6422BERZ)	6422B EVEZ	-20 to +85	38 Ld EPTSSOP	M38.173B

*Add "-T" suffix for tape and reel.

NOTE: Intersil Pb-free plus anneal products employ special Pb-free material sets; molding compounds/die attach materials and 100% matte tin plate termination finish, which are RoHS compliant and compatible with both SnPb and Pb-free soldering operations. Intersil Pb-free products are MSL classified at Pb-free peak reflow temperatures that meet or exceed the Pb-free requirements of IPC/JEDEC J STD-020.

Pinouts

ISL6422B
(38 LD EPTSSOP)
TOP VIEW

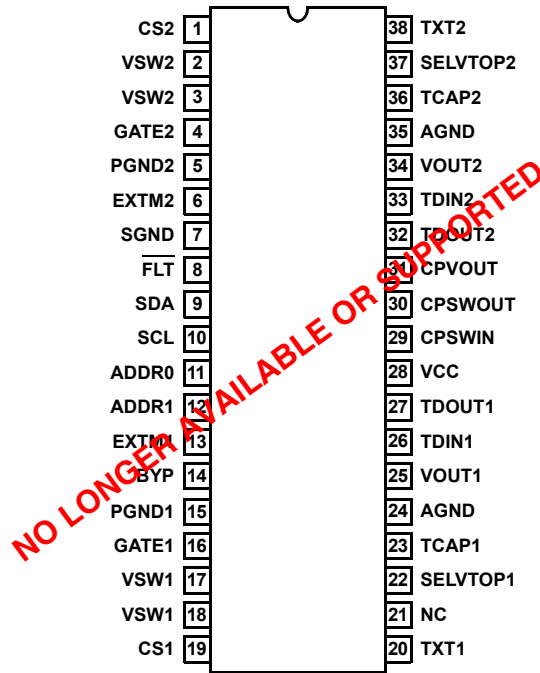

ISL6422B
(40 LD 6X6 QFN)
TOP VIEW

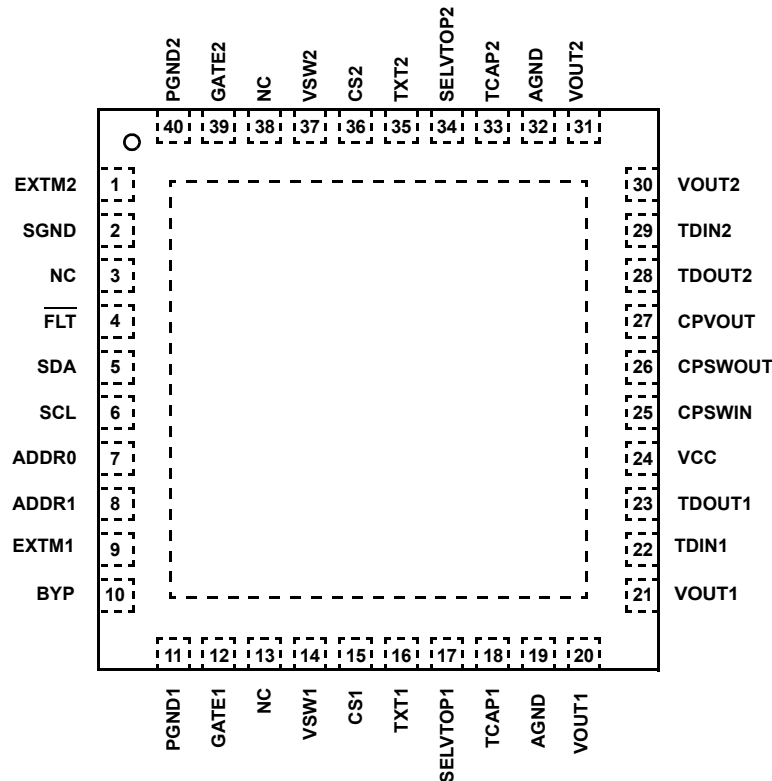

Block Diagram

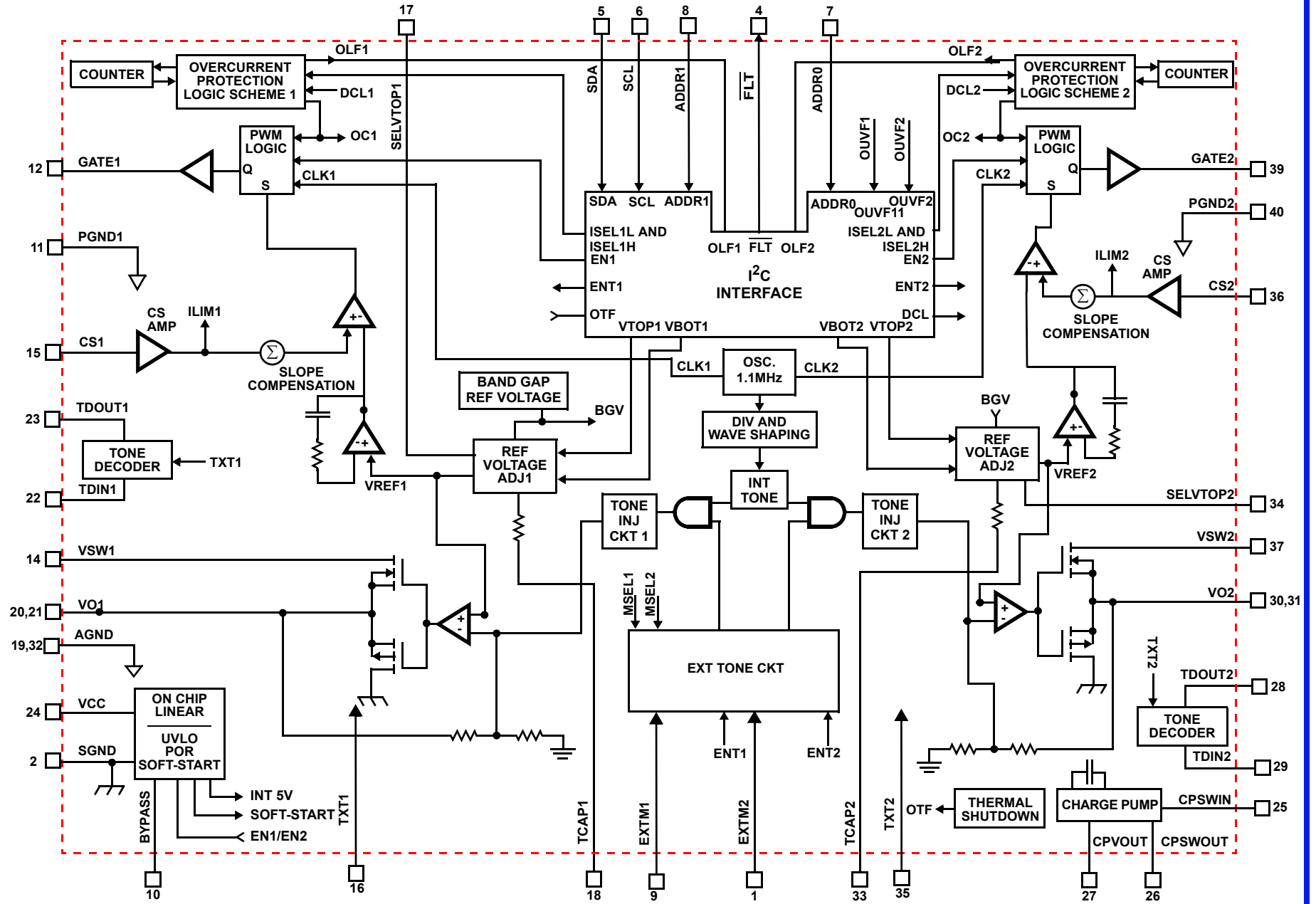

NOTE:

1. Pinouts shown are for the QFN package.

Typical Application Schematic QFN

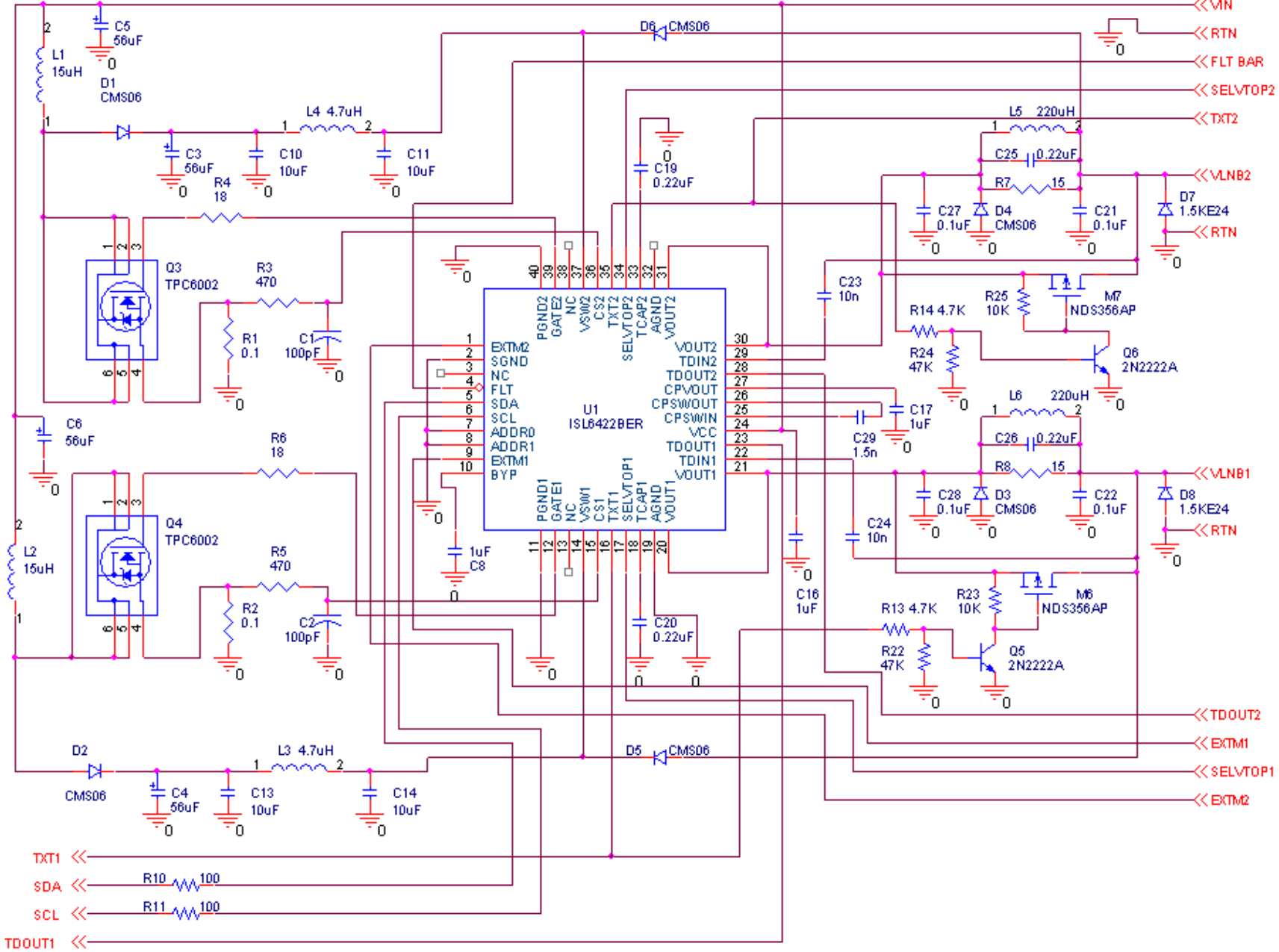

Absolute Maximum Ratings

Supply Voltage, V_{CC} 8.0V to 18.0V
 Logic Input Voltage Range
 (SDA, SCL, ADDR0/1, CS1/2, EXT1/2,
 SELVTOP1/, TCAP1/2, TDIN1/2, TXT1/2)..... -0.5V to 7V

Thermal Information

Thermal Resistance (Typical, Notes 2, 3) θ_{JA} (°C/W) θ_{JC} (°C/W)
 EPTSSOP Package 29 4
 QFN Package 34 6
 Maximum Junction Temperature (Note 4) +150°C
 Maximum Storage Temperature Range -40°C to +150°C
 Operating Temperature Range -20°C to +85°C
 Pb-free reflow profile see link below
<http://www.intersil.com/pbfree/Pb-FreeReflow.asp>

CAUTION: Do not operate at or near the maximum ratings listed for extended periods of time. Exposure to such conditions may adversely impact product reliability and result in failures not covered by warranty.

NOTES:

- θ_{JA} is measured in free air with the component mounted on a high effective thermal conductivity test board with "direct attach" features. See Tech Brief TB379.
- For θ_{JC} , the "case temp" location is the center of the exposed metal pad on the package underside.
- The device junction temperature should be kept below +150°C. Thermal shut-down circuitry turns off the device if junction temperature exceeds +150°C typically.

Electrical Specifications $V_{CC} = 12V$, $T_A = -20^\circ C$ to $+85^\circ C$, unless otherwise noted. Typical values are at $T_A = +25^\circ C$. EN1/2 = H, VTOP1/2 = L, VBOT1/2 = L, ENT1/2 = L, DCL = L, MSEL1/2 = L, $I_{OUT} = 12mA$, unless otherwise noted. See software description section for I²C access to the system.

PARAMETER	SYMBOL	TEST CONDITIONS	MIN	TYP	MAX	UNITS
Operating Supply Voltage Range			8	12	14	V
Standby Supply Current		EN1 = EN2 = L	-	1.5	3.0	mA
Supply Current	I_{IN}	EN1 = EN2 = VTOP1 = VTOP2 = VBOT1 = VBOT2 = ENT1 = ENT2 = H, No Load	-	4.0	8.0	mA
UNDERVOLTAGE LOCKOUT						
Start Threshold			7.50	-	7.97	V
Stop Threshold			7.00	-	7.55	V
Start to Stop Hysteresis			350	400	500	mV
SOFT-START						
COMP Rise Time (Note 5)		(Note 5)	-	8196	-	Cycles
Output Voltage (Note 5)	V_{O1}	(Refer to Table 11)	13.04	13.30	13.56	V
	V_{O1}	(Refer to Table 11)	14.02	14.30	14.58	V
	V_{O1}	(Refer to Table 11)	17.94	18.30	18.66	V
	V_{O1}	(Refer to Table 11)	19.00	19.30	19.68	V
	V_{O2}	(Refer to Table 15)	13.04	13.30	13.56	V
	V_{O2}	(Refer to Table 15)	14.02	14.30	14.58	V
	V_{O2}	(Refer to Table 15)	17.94	18.30	18.66	V
	V_{O2}	(Refer to Table 15)	19.00	19.30	19.68	V
Line Regulation	DV_{O1} , DV_{O2}	$V_{IN} = 8V$ to $14V$; V_{O1} , $V_{O2} = 13V$	-	4.0	40.0	mV
		$V_{IN} = 8V$ to $14V$; V_{O1} , $V_{O2} = 18V$	-	4.0	60.0	mV
Load Regulation	DV_{O1} , DV_{O2}	$I_O = 12mA$ to $350mA$	-	50	80	mV
		$I_O = 12mA$ to $750mA$ (Note 6)	-	100	200	mV

Electrical Specifications $V_{CC} = 12V$, $T_A = -20^{\circ}C$ to $+85^{\circ}C$, unless otherwise noted. Typical values are at $T_A = +25^{\circ}C$. EN1/2 = H, VTOP1/2 = L, VBOT1/2 = L, ENT1/2 = L, DCL = L, MSEL1/2 = L, $I_{OUT} = 12mA$, unless otherwise noted. See software description section for I²C access to the system. **(Continued)**

PARAMETER	SYMBOL	TEST CONDITIONS	MIN	TYP	MAX	UNITS
Dynamic Output Current Limiting (Note 9)	I_{MAX}	DCL = 0, ISEL1H, ISEL2H = 0, ISEL1L, ISEL2L = 0, ISEL1R, ISEL2R = 0	270	305	345	mA
		DCL = 0, ISEL1H, ISEL2H = 0, ISEL1L, ISEL2L = 0, ISEL1R, ISEL2R = 1	350	388	435	mA
		DCL = 0, ISEL1H, ISEL2H = 0, ISEL1L, ISEL2L = 1, ISEL1R, ISEL2R = 1	515	570	630	mA
		DCL = 0, ISEL1H, ISEL2H = 1, ISEL1L, ISEL2L = 0, ISEL1R, ISEL2R = 1	635	705	775	mA
		DCL = 0, ISEL1/2H = 1, ISEL1/2L = 1, ISEL1/2R = 1	800	890	980	mA
Dynamic Overload Protection Off Time	t_{OFF}	DCL = L, Output Shorted (Note 9)	-	900	-	ms
Dynamic Overload Protection On Time	t_{ON}		-	51	-	ms
Static Output Current Limiting	I_{MAX}	DCL = 1 (Notes 6, 9)	-	990	-	mA
Cable Fault CABF Asserted High	I_{CAB}	EN1 and EN2 = 1;	2	10	20	mA
TONE OSCILLATOR						
Tone Frequency	f_{tone}	ENT1, ENT2 = H	20.0	22.0	24.0	kHz
Tone Amplitude	V_{tone}	ENT1, ENT2 = H	500	680	800	mV
Tone Duty Cycle	$d_{C_{tone}}$	ENT1, ENT2 = H	40	50	60	%
Tone Rise or Fall Time	t_r, t_f	ENT1, ENT2 = H	5	10	14	μs
TONE DECODER						
Input Amplitude	V_{TDIN}		200	-	1000	mV
Frequency Capture Range	F_{TDIN}		17.5	-	26.5	kHz
Input Impedance	Z_{DET}		-	8.6	-	$k\Omega$
Detector Output Voltage	V_{TDOUT_L}	Tone Present, $I_{LOAD} = 3mA$	-	-	0.4	V
Detector Output Leakage	I_{TDOUT_H}	Tone absent, $V_O = 6V$	-	-	10	μA
Tone Decoder Rx Threshold	V_{RXth}	TXT1, TXT2 = L	100	150	200	mV
Tone Decoder Tx Threshold	V_{TXth}	TXT1, TXT2 = H	400	450	500	mV
LINEAR REGULATOR						
Drop-out Voltage		$I_{OUT} = 750mA$ (Note 6)	-	0.8	1.05	V
Output Backward Leakage Current	I_{BKLK}	EN1 and EN2 = 0; $V_{OBK} = 27V$	-	2.0	3.0	mA
Output Backward Leakage Current	I_{BKLK}	EN1 and EN2 = 0; $V_{OBK} = 28V$	-	3.0	17.0	mA
Output Backward Current Threshold	I_{BKTH}	EN1 and EN2 = 1; $V_{FAULT} = 19V$ (Note 8)	-	140	-	mA
Output Backward Current Limit	I_{BKLM}	EN1 and EN2 = 1; $V_{FAULT} = 19V$ (Note 8)	-	350	-	mA
Output Backward Voltage	V_{OBK}	EN1 and EN2 = 0	-	-	27	V
Output Undervoltage (Asserted high during soft-start)		OUVF1, OUVF2 bit is asserted high, measured from the typ output set value	-6	-	-2	%
Output Overvoltage (Asserted high during soft-start)		OUVF1, OUVF2 bit is asserted high, measured from the typ output set value	+2	-	+6	%

Electrical Specifications $V_{CC} = 12V$, $T_A = -20^{\circ}C$ to $+85^{\circ}C$, unless otherwise noted. Typical values are at $T_A = +25^{\circ}C$. EN1/2 = H, VTOP1/2 = L, VBOT1/2 = L, ENT1/2 = L, DCL = L, MSEL1/2 = L, $I_{OUT} = 12mA$, unless otherwise noted. See software description section for I²C access to the system. **(Continued)**

PARAMETER	SYMBOL	TEST CONDITIONS	MIN	TYP	MAX	UNITS
TXT1/2, EXTM1/2, SELVTOP1/2 and ADDR0/1 INPUT PINS (Note 9)						
Asserted LOW			-	-	0.8	V
Asserted HIGH			1.7	-	-	V
Input Current			-	25	-	μA
CURRENT SENSE (CS pin)						
Input Bias Current	I_{BIAS}		-	700	-	nA
Overcurrent Threshold	V_{CS}	Static current mode, DCL = H	325	450	500	mV
ERROR AMPLIFIER						
Open Loop Voltage Gain	A_{OL}	(Note 6)	-	93	-	dB
Gain Bandwidth Product	GBP	(Note 6)	-	14	-	MHz
PWM						
Maximum Duty Cycle			90	93	-	%
Minimum Pulse Width		(Note 6)	-	20	-	ns
OSCILLATOR						
Oscillator Frequency	f_o	Fixed at $(20)(f_{tone})$	396	440	484	kHz
Thermal Shutdown						
Temperature Shutdown Threshold		(Note 6)	-	150	-	
Temperature Shutdown Hysteresis		(Note 6)	-	20	-	
FLT						
\overline{FLT} (released)		$V_O = 6V$	-	-	10	μA
\overline{FLT} (asserted)		$I_{SINK} = 3.2mA$ (1.5k pull-up resistor to 5V)	-	-	0.4	V

NOTES:

- Internal digital soft-start.
- Limits established by characterization and are not production tested.
- The EXTM1, EXTM2, SELVTOP1, SELVTOP2, TXT1, TXT2 and ADDR0, ADDR1 pins have 200k internal pull-downs
- On exceeding this backward current limit threshold for a period of 2ms the device enters the backward dynamic current limit mode (350mA typ) and the BCF I²C bit is set. The dynamic back current limit duty ratio during a BCF is ON = 2ms/OFF = 50ms. The output will remain clamped to the fault output voltage till released. On removal of the fault condition the device returns to normal operation.
- In the Dynamic current limit mode the output is ON for 51ms and OFF for 900ms. But remains continuously ON in the Static mode. When tone is ON the minimum current limit is 50mA lower the values indicated in the table.

Tone Waveform

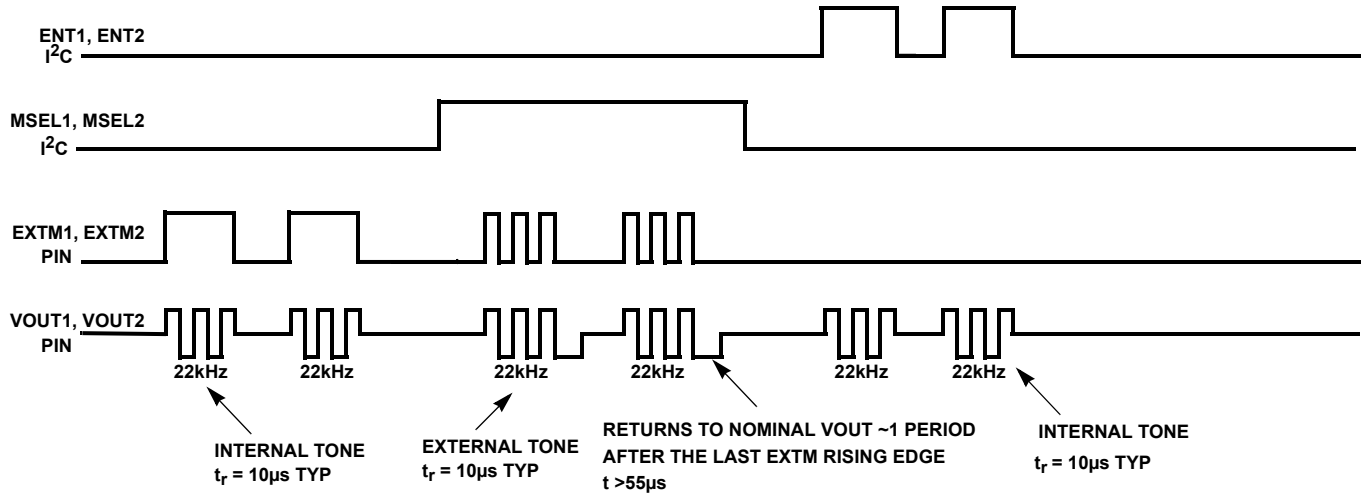

FIGURE 1. TONE WAVEFORM

NOTES:

- The logic presented to the signal pin TXT1, TXT2 changes the decoder threshold during tone Transmit and Receive. TTH1, TTH2 allows threshold control through the I²C provided that TXT1, TXT2 = 0
- The tone rise and fall times are not shown due to resolution of graphics. It is 10 μs typ for 22kHz.
- The EXTM1, EXTM2 pins have input thresholds of $V_{IL(max)} = 0.8V$ and $V_{IH(min)} = 1.7V$

Typical Performance Curves

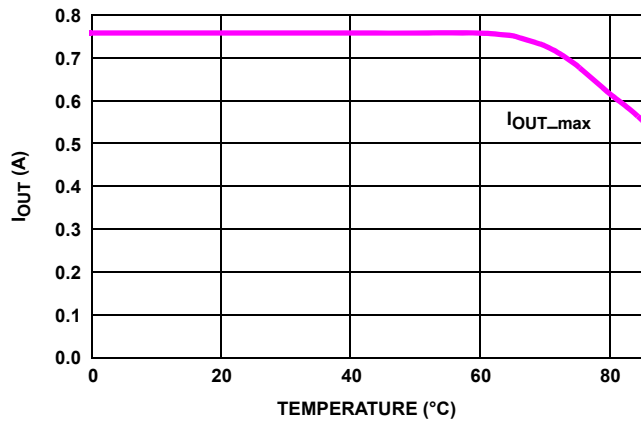

FIGURE 2. OUTPUT CURRENT DERATING (EPTSSOP)

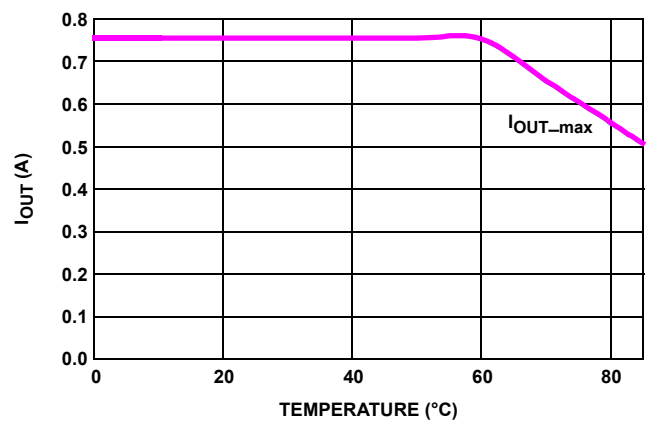

FIGURE 3. OUTPUT CURRENT DERATING (6x6 QFN)

NOTE: With both channels in simultaneous operation at rated output

Functional Pin Description

SYMBOL	FUNCTION
SDA	Bidirectional data from/to I ² C bus.
SCL	Clock from I ² C bus.
VSW1, VSW2	Input of the linear post-regulator.
PGND1, PGND2	Dedicated ground for the output gate driver of respective PWM.
CS1, CS2	Current sense input; connect the sense resistor R _{SC} at this pin for desired overcurrent value for respective PWM.
SGND	Small signal ground for the IC.
TCAP1, TCAP2	Capacitor for setting rise and fall time of the output of LNB A and LNB B respectively. Typical value is 0.15μF.
BYPASS	Bypass capacitor for internal 5V.
TXT1, TXT2	TXT1 and TXT2 are the Tone Transmit signal inputs used to change the tone decoder threshold. The threshold is 200mV max for the Rx mode. The TXT1, TXT2 are set low and the threshold is 400mV min in the Tx mode when TXT1, TXT2 are set high.
VCC	Main power supply to the chip.
GATE1, GATE2	These are the gate drive outputs of PWM A and PWM B respectively. These high current driver outputs are capable of driving the gate of a power FET. These outputs are actively held low when V _{CC} is below the UVLO threshold.
VO1, VO2	Output voltage for LNB A and LNB B respectively.
ADDR0, ADDR1	Address pins select four different device addresses per Table 19.
EXTM1, EXTM2	These pins can be used in two ways : 1) As an input for externally modulated DiSEqC tone signal which is transferred to the symmetrically onto V _{OUT} 2) Alternatively apply a DiSEqC modulation envelope which modulates an internal tone and then transfers it symmetrically onto V _{OUT}
$\overline{\text{FLT}}$	This is an open drain output from the controller. When the $\overline{\text{FLT}}$ goes low it indicates that an Over-Temperature, Over Load Fault, UVLO, or a condition causing I ² C to reset has occurred. The processor should then look at the I ² C register to get the actual cause of the error. A high on the $\overline{\text{FLT}}$ indicates that the device is functioning normally.
CPVOUT	Charge pump decoupling capacitor is to be connected to this pin.
SELVTOP1, SELVTOP2	When this pin is low, the V _{OUT} is in the 13.3V/14.3V range selected by the I ² C bit VBOT1 and VBOT2. When this pin is high, the 18.3V/19.3V range is selected by the I ² C bit VTOP1 and VTOP2. The voltage select pin voltage VSPEN1, VSPEN2 I ² C bit must be set low for the SELVTOP1, SELVTOP2 pins to be active. Setting VSPEN1, VSPEN2 high disables these pins and voltage selection will be done using the I ² C bits VBOT1, VBOT2 and VTOP1, VTOP2 only.
TDIN1, TDIN2, TDOUT1, TDOUT2	TDIN1, TDIN2 are the tone decoder inputs for Channels 1 and 2. TDOUT1, TDOUT2 are the tone detector outputs for Channels 1 and 2. TDOUT1, TDOUT2 are open drain outputs.

Functional Description

The ISL6422B dual output voltage regulator makes an ideal choice for advanced satellite set-top box and personal video recorder applications. Both supply and control voltage outputs for two low-noise blocks (LNBs) are available simultaneously in any output configuration. The device utilizes built-in DC/DC step up converters that, from a single supply source ranging from 8V to 14V, generate the voltages that enable the linear post-regulators to work with a minimum of dissipated power. An undervoltage lockout circuit disables the device when V_{CC} drops below a fixed threshold (7.5V typical).

DiSEqC Encoding

The internal oscillator is factory-trimmed to provide a tone of 22kHz in accordance with DiSEqC (EUTELSAT) standards. No further adjustment is required. The tone oscillator can be controlled either by the I²C interface (ENT1, ENT2 bit) or by a dedicated pin (EXTM1, EXTM2) that allows immediate DiSEqC data encoding separately for each LNB. All the functions of this IC are controlled via the I²C bus by writing to the system registers. The same registers can be read back, and four bits will report the diagnostic status. The internal oscillator operates the converters at twenty times the 22k tone frequency. The device offers full I²C compatibility and supports 2.5V, 3.3V or 5V logic, and up to 400kHz operation.

If the Tone Enable (ENT1, ENT2) bit is set LOW and the MSEL1, MSEL2 bits set LOW through I²C, then the EXTM1, EXTM2 terminal activates the internal tone signal, modulating the DC output with a 680mV_{P-P} typ symmetrical tone waveform. The presence of this signal usually provides the LNB with information about the band to be received.

Burst coding of the tone can be accomplished due to the fast response of the EXTM1, EXTM2 input and rapid tone response. This allows implementation of the DiSEqC (EUTELSAT) protocols.

When the ENT1/2 bit is set HIGH, a continuous 22kHz tone is generated regardless of the EXTM1, EXTM2 pin logic status for the corresponding regulator channel (LNB-A or LNB-B). The ENT1, ENT2 bit must be set LOW when the EXTM1 and/or EXTM2 pin is used for DiSEqC encoding.

The EXTM1 and EXTM2 pins also accept an externally modulated tone command when the MSEL1 and MSEL2 I²C bit is set high.

DiSEqC Decoder

TDIN1, TDIN2 are the inputs to the tone decoders of Channels 1 and 2 respectively. They accept the tone signal derived from V_{OUT} thru the 10nF decoupling capacitor. The detector threshold can be set to 200mV max in the Receive mode and to 400mV min in the Transmit mode by means of the logic presented to the TXT1, TXT2 pin. If tone is detected, the open drain pins TDOUT1, TDOUT2 are

asserted low. This also enables the tone diagnostics to be performed, apart from the normal tone detection function.

Linear Regulator

The output linear regulator will sink and source current. This feature allows full modulation capability into capacitive loads as high as 0.75μF. In order to minimize the power dissipation, the output voltage of the internal step-up converter is adjusted to allow the linear regulator to work at minimum dropout.

When the device is put in the shutdown mode (EN1, EN2 = LOW), both PWM power blocks are disabled. (i.e. when EN1 = 0, PWM1 is disabled, and when EN2 = 0, PWM2 is disabled).

When the regulator blocks are active (EN1, EN2 = HIGH and VSPEN1, VSPEN2 = LOW), the output can be controlled via I²C logic to be 13V/14V or 18V/19V (typical) by means of the VTOP1, VTOP2 and VBOT1, VBOT2 bits (Voltage Select) for remote controlling of non-DiSEqC LNBs.

When the regulator blocks are active (EN1, EN2 = HIGH and VSPEN1, VSPEN2 = HIGH), the VBOT1, VBOT2 and SELVTOP1, SELVTOP2 pin will control the output between 13V and 14V and the VTOP1, VTOP2 and SELVTOP1, SELVTOP2 pin will control the output between 18V and 19V.

Output Timing

The output voltage rise and fall times can be set by an the external capacitor on the TCAP pin. The output rise and fall times is given by Equation 1:

$$C = \frac{327.6t}{\Delta V} \quad (\text{EQ. 1})$$

Where C is the TCAP value in nF, t is the required slew rate in ms and ΔV is the differential transition voltage from low output voltage range to the high output range in Volts.

The recommended value for TCAP is 0.15μF. Too large a value of TCAP prevents the output from rising to the nominal value, within the soft-start time when the error amplifier is released. Too small a value of the TCAP can cause high peak currents in the boost circuit, for example, a 10V/ms slew on a 80μF VSW capacitor with an inductor of 15μH can cause a peak inductor current of approximately 2.3A.

Current Limiting

Dynamic current limiting block has five thresholds that can be selected by the ISEL1H, ISEL2H, ISEL1L, ISEL2L, ISLE1R, ISLE2R bits of the SR. Refer to Table 8 and Table 9 for threshold selection using these bits. The DCL bit has to be set to low for this mode of operation. In the dynamic overcurrent mode a fault exceeding the selected overcurrent threshold for a period greater than 51ms will shutdown the output for 900ms, during which the I²C bit OLF is set HIGH. At the end of 900ms, the OLF bit is returned to low state, a soft-start cycle (~20ms long) is initiated to ramp VSW and V_{OUT} back up. If the fault is still present, the overcurrent will

be reached early in the soft-start cycle and a 51ms shutdown timer will be started again. If the fault is still present at the end of the 51ms, the OLF bit is again set high and the device once again enters the 900ms OFF time. This dynamic operation can greatly reduce the power dissipation in a short circuit condition, still ensuring excellent power-on start-up in most conditions.

However, there could be some cases in which a highly capacitive load on the output may cause a difficult start-up when the dynamic protection is chosen. This can be solved by initiating any power start-up in static mode (DCL = HIGH) and then switching to the dynamic mode (DCL = LOW) after a chosen amount of time. When in static mode, the OLF1, OLF2 bit goes HIGH when the current clamp limit is reached and returns LOW at the end of the initial power on soft-start. In the static mode the output current through the linears is limited to 990mA typ.

When a 19.3V line is connected onto a VOUT1 or VOUT2 that has been set to 13.3V, the linear will then enter a back current limited state. When a back current of greater than 140mA typ is sensed at the lower FET of the linear for a period greater than 2ms, the output is disabled for a period of 50ms and the BCF1, BCF2 bit are set. If the 19.3V remains connected, the output will cycle through the ON = 2ms/OFF = 50ms. The output will return to the setpoint when the fault is removed. BCF bit is set high during the 50ms OFF period.

Thermal Protection

This IC is protected against overheating. When the junction temperature exceeds +150°C (typical), the step-up converter and the linear regulator are shut off and the OTF bit of the SR is set HIGH. Normal operation is resumed and the OTF bit is reset LOW when the junction is cooled down to +130°C (typical).

If a part is repeatedly driven to the over-temperature shutdown, the chip is latched off after the fourth occurrence and the I²C bit is latched HIGH and the FLT bar LOW. This OTF counter and the FLT bar can be reset and the chip restarted by either a power down/up and reload the I²C or power can be left on and the reset accomplished by toggling the I²C bit EN low then back HIGH.

External Output Voltage Selection

The output voltage can be selected by the I²C bus. Additionally, the package offers two pins (SELVTOP1, SELVTOP2) for independent 13V thru 19V output voltage selection.

TABLE 1.

VSPEN1/2	VTOP1/2	VBOT1/2	SELVTOP1/2	VOUT1/2 (V)
0	x	0	0	13.3
0	x	1	0	14.3
0	0	x	1	18.3
0	1	x	1	19.3
1	0	0	x	13.3
1	0	1	x	14.3
1	1	0	x	18.3
1	1	1	x	19.3

I²C Bus Interface for ISL6422B

(Refer to Philips I²C Specification, Rev. 2.1)

Data transmission from main microprocessor to the ISL6422B (and vice versa) takes place through the two wire I²C bus interface, consisting of the two lines, SDA and SCL. Both SDA and SCL are bidirectional lines. They are connected to a positive supply voltage via a pull-up resistor. (Pull-up resistors to positive supply voltage must be externally connected). When the bus is free, both lines are HIGH. The output stages of ISL6422B will have an open drain/open collector in order to perform the wired-AND function. Data on the I²C bus can be transferred up to 100kbps in the standard-mode or up to 400kbps in the fast-mode. The level of logic "0" and logic "1" depends value of V_{DD} as per the "Electrical Specifications" table on page 5. One clock pulse is generated for each data bit transferred.

Data Validity

The data on the SDA line must be stable during the HIGH period of the clock. The HIGH or LOW state of the data line can only change when the clock signal on the SCL line is LOW. Refer to Figure 4.

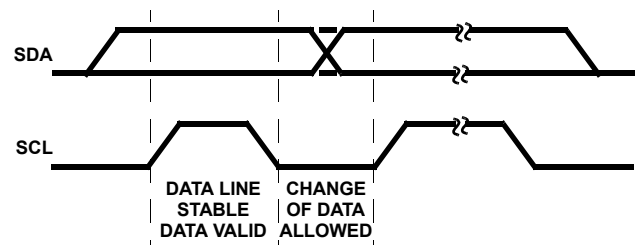

FIGURE 4. DATA VALIDITY

START and STOP Conditions

As shown in Figure 5, START condition is a HIGH to LOW transition of the SDA line while SCL is HIGH.

The STOP condition is a LOW to HIGH transition on the SDA line while SCL is HIGH. A STOP condition must be sent before each START condition.

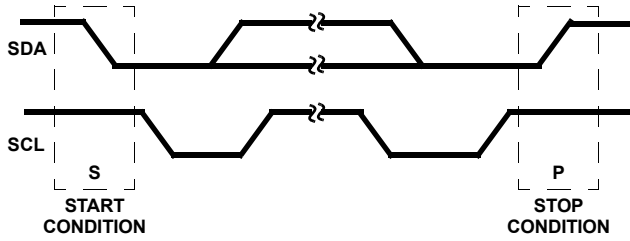

FIGURE 5. START AND STOP WAVEFORMS

Byte Format

Every byte put on the SDA line must be eight bits long. The number of bytes that can be transmitted per transfer is unrestricted. Each byte has to be followed by an acknowledge bit. Data is transferred with the most significant bit first (MSB).

Acknowledge

The master (microprocessor) puts a resistive HIGH level on the SDA line during the acknowledge clock pulse (Figure 6). The peripheral that acknowledges has to pull-down (LOW) the SDA line during the acknowledge clock pulse so that the SDA line is stable LOW during this clock pulse (of course, set-up and hold times must also be taken into account).

The peripheral which has been addressed has to generate an acknowledge after the reception of each byte, otherwise the SDA line remains at the HIGH level during the ninth clock pulse time. In this case, the master transmitter can generate the STOP information in order to abort the transfer. The ISL6422B will not generate the acknowledge if the POWER OK signal from the UVLO is LOW.

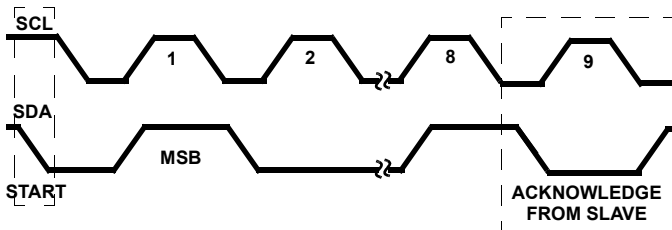

FIGURE 6. ACKNOWLEDGE ON THE I²C BUS

Transmission Without Acknowledge

Avoiding detection of the acknowledgement, the microprocessor can use a simpler transmission; it waits one clock without checking the slave acknowledging, and sends the new data. Although, this approach is less protected from error and decreases the noise immunity.

ISL6422B Software Description

Interface Protocol

The interface protocol is comprised of the following, as shown below in Table 2:

- A start condition (S)
- A chip address byte (MSB on left; the LSB bit determines read (1) or write (0) transmission) (the assigned I²C slave address for the ISL6422B is 0001 00XX)
- A sequence of data (1 byte + Acknowledge)
- A stop condition (P)

TABLE 2. INTERFACE PROTOCOL

S	0	0	0	1	0	0	0	R/W	ACK	Data (8 bits)	ACK	P
---	---	---	---	---	---	---	---	-----	-----	---------------	-----	---

System Register Format

- R, W = Read and Write bit
- R = Read-only bit

All bits reset to 0 at Power-On

TABLE 3. STATUS REGISTER 1 (SR1)

R, W	R, W	R, W	R	R	R	R	R
SR1H	SR1M	SR1L	OTF	CABF1	OUVF1	OLF1	BCF1

TABLE 4. TONE REGISTER 2 (SR2)

R, W	R, W	R, W	R, W	R, W	R, W	R, W	R, W
SR2H	SR2M	SR2L	ENT1	MSEL1	TTH1	X	X

TABLE 5. COMMAND REGISTER 3 (SR3)

R, W	R, W	R, W	R, W	R, W	R, W	R, W	R, W
SR3H	SR3M	SR3L	DCL1	VSPEN1	ISEL1R	ISEL1H	ISEL1L

TABLE 6. CONTROL REGISTER 4 (SR4)

R, W	R, W	R, W	R, W	R, W	R, W	R, W	R, W
SR4H	SR4M	SR4L	EN1	X	X	VTOP1	VBOT1

TABLE 7. STATUS REGISTER 5 (SR5)

R, W	R, W	R, W	X	R	R	R	R
SR5H	SR5M	SR5L	X	CABF2	OUVF2	OLF2	BCF2

TABLE 8. TONE REGISTER 6 (SR6)

R, W	R, W	R, W	R, W	R, W	R, W	R, W	R, W
SR6H	SR6M	SR6L	ENT2	MSEL2	TTH2	X	X

TABLE 9. COMMAND REGISTER 7 (SR7)

R, W	R, W	R, W	R, W	R, W	R, W	R, W	R, W
SR7H	SR7M	SR7L	DCL2	VSPEN2	ISEL2R	ISEL2H	ISEL2L

TABLE 10. CONTROL REGISTER 8 (SR8)

R, W	R, W	R, W	R, W	R, W	R, W	R, W	R, W
SR8H	SR8M	SR8L	EN2	X	X	VTOP2	VBOT2

NOTE: X = Bit not used

Transmitted Data (I²C bus WRITE mode)

When the R/W bit in the chip is set to 0, the main microprocessor can write on the system registers (SR1 thru

SR8) of the ISL6422B via I²C bus. These will be written by the microprocessor as shown below. The spare bits of registers can be used for other functions.

TABLE 11. STATUS REGISTER SR1 CONFIGURATION

SR1H	SR1M	SR1L	OTF	CABF1	OUVF1	OLF1	BCF1	FUNCTION
0	0	0	X	X	X	X	X	SR1 is selected
0	0	0	X	X	X	0	X	I _{OUT} ≤ set limit, Normal Operation
0	0	0	X	X	X	1	X	I _{OUT} > Static/Dynamic Limiting Mode/Power blocks disabled
0	0	0	X	X	X	X	0	I _{OBCK} ≤ set limit, Normal Operation
0	0	0	X	X	X	X	1	I _{OBCK} > Dynamic Limiting Mode/Power blocks disabled
0	0	0	X	X	0	X	X	V _{IN} /V _{OUT} within specified range
0	0	0	X	X	1	X	X	V _{IN} /V _{OUT} is not within specified range
0	0	0	X	0	X	X	X	Cable is connected, I _O is > 20mA
0	0	0	X	1	X	X	X	Cable is open, I _O < 2mA
0	0	0	0	X	X	X	X	T _J ≤ +130°C, Normal operation
0	0	0	1	X	X	X	X	T _J > +150°C, Power blocks disabled

TABLE 12. TONE REGISTER SR2 CONFIGURATION

SR2H	SR2M	SR2L	ENT1	MSEL1	TTH1	X	X	FUNCTION
0	0	1	X	X	X	X	X	SR2 is selected
0	0	1	0	0	X	X	X	Int Tone = 22kHz, modulated by EXT _M , t _r , t _f = 10μs typ
0	0	1	0	1	X	X	X	Ext 22k modulated input, t _r , t _f = 10μs typ
0	0	1	1	0	X	X	X	Int Tone = 22kHz, modulated by ENT bit, t _r , t _f = 10μs typ
0	0	1	X	X	0	X	X	TXT = 0; Decoder Rx threshold is set at 200mV max
0	0	1	X	X	1	X	X	TXT = 0; Decoder Tx threshold is set at 400mV min

NOTE: X indicates "Read Only" and is a "Don't Care" for the Write mode.

TABLE 13. COMMAND REGISTER SR3 CONFIGURATION

SR3H	SR3M	SR3L	DCL1	VSPEN1	ISEL1R	ISEL1H	ISEL1L	FUNCTION
0	1	0	X	X	X	X	X	SR3 is selected
0	1	0	0	X	0	X	X	I _{OUT1} limit threshold = 305mA typ
0	1	0	0	X	1	0	0	I _{OUT1} limit threshold = 388mA typ
0	1	0	0	X	1	0	1	I _{OUT1} limit threshold = 570mA typ
0	1	0	0	X	1	1	0	I _{OUT1} limit threshold = 705mA typ
0	1	0	0	X	1	1	1	I _{OUT1} limit threshold = 890mA typ
0	1	0	1	X	X	X	X	Dynamic current limit NOT selected
0	1	0	0	X	X	X		Dynamic current limit selected
0	1	0	X	0	X	X	X	SELV _{TOP} H/W pin Enabled
0	1	0	X	1	X	X	X	SELV _{TOP} H/W pin Disabled

NOTE: X indicates "Read Only" and is a "Don't Care" for the Write mode.

TABLE 14. CONTROL REGISTER SR4 CONFIGURATION

SR4H	SR4M	SR4L	EN1	X	X	VTOP1	VBOT1	FUNCTION
0	1	1	1	X	X	0	0	SR4 is selected
0	1	1	1	X	X	0	0	VSPEN1 = SELVTOP1 = 0, VOUT1 = 13V, VBOOST1 = 13V + VDROP
0	1	1	1	X	X	0	1	VSPEN1 = SELVTOP1 = 0, VOUT1 = 14V, VBOOST1 = 14V + VDROP
0	1	1	1	X	X	1	0	VSPEN1 = SELVTOP1 = 0, VOUT1 = 13V, VBOOST1 = 13V + VDROP
0	1	1	1	X	X	1	1	VSPEN1 = SELVTOP1 = 0, VOUT1 = 14V, VBOOST1 = 14V + VDROP
0	1	1	1	X	X	0	0	VSPEN1 = 0, SELVTOP1 = 1, VOUT1 = 18V, VBOOST1 = 18V + VDROP
0	1	1	1	X	X	0	1	VSPEN1 = 0, SELVTOP1 = 1, VOUT1 = 18V, VBOOST1 = 18V + VDROP
0	1	1	1	X	X	1	0	VSPEN1 = 0, SELVTOP1 = 1, VOUT1 = 19V, VBOOST1 = 19V + VDROP
0	1	1	1	X	X	1	1	VSPEN1 = 0, SELVTOP1 = 1, VOUT1 = 19V, VBOOST1 = 19V + VDROP
0	1	1	1	X	X	0	0	VSPEN1 = 1, SELVTOP1 = X VOUT1 = 13V, VBOOST1 = 13V + VDROP
0	1	1	1	X	X	0	1	VSPEN1 = 1, SELVTOP1 = X VOUT1 = 14V, VBOOST1 = 14V + VDROP
0	1	1	1	X	X	1	0	VSPEN1 = 1, SELVTOP1 = X VOUT1 = 18V, VBOOST1 = 18V + VDROP
0	1	1	1	X	X	1	1	VSPEN1 = 1, SELVTOP1 = X VOUT1 = 19V, VBOOST1 = 19V + VDROP
0	1	1	0	X	X	X	X	PWM and Linear for Channel 1 disabled

NOTE: X indicates "Read Only" and is a "Don't Care" for the Write mode.

TABLE 15. STATUS REGISTER SR5 CONFIGURATION

SR5H	SR5M	SR5L	X	CABF2	OUVF2	OLF2	BCF2	FUNCTION
1	0	0	X	X	X	X	X	SR5 is selected
1	0	0	X	X	X	0	X	$I_{OUT} \leq$ set limit, Normal Operation
1	0	0	X	X	X	1	X	$I_{OUT} >$ Static/Dynamic Limiting Mode/Power blocks disabled
1	0	0	X	X	X	X	0	$I_{OBACK} \leq$ set limit, Normal Operation
1	0	0	X	X	X	X	1	$I_{OBACK} >$ Dynamic Limiting Mode/Power blocks disabled
1	0	0	X	X	0	X	X	V_{IN}/V_{OUT} within specified range
1	0	0	X	X	1	X	X	V_{IN}/V_{OUT} is not within specified range
1	0	0	X	0	X	X	X	Cable is connected, I_O is $> 20mA$
1	0	0	X	1	X	X	X	Cable is open, $I_O < 2mA$

TABLE 16. TONE REGISTER SR6 CONFIGURATION

SR6H	SR6M	SR6L	ENT2	MSEL2	TTH2	X	X	FUNCTION
1	0	1	X	X	X	X	X	SR2 is selected
1	0	1	0	0	X	X	X	Int Tone = 22kHz, modulated by EXTM2, $t_r, t_f = 10\mu s$ typ
1	0	1	0	1	X	X	X	Ext 22k modulated input, $t_r, t_f = 10\mu s$ typ
1	0	1	1	0	X	X	X	Int Tone = 22kHz, modulated by ENT2 bit, $t_r, t_f = 10\mu s$ typ
1	0	1	X	X	0	X	X	TXT2 = 0; Decoder Rx threshold is set at 200mV max
1	0	1	X	X	1	X	X	TXT2 = 0; Decoder Tx threshold is set at 400mV min

NOTE: X indicates "Read Only" and is a "Don't Care" for the Write mode.

TABLE 17. COMMAND REGISTER SR7 CONFIGURATION

SR7H	SR7M	SR7L	DCL2	VSPEN2	ISEL2R	ISEL2H	ISEL2L	FUNCTION
1	1	0	X	X	X	X	X	SR7 is selected
1	1	0	0	X	0	X	X	IOUT1 limit threshold = 305mA typ
1	1	0	0	X	1	0	0	IOUT1 limit threshold = 388mA typ
1	1	0	0	X	1	0	1	IOUT1 limit threshold = 570mA typ
1	1	0	0	X	1	1	0	IOUT1 limit threshold = 705mA typ
1	1	0	0	X	1	1	1	IOUT1 limit threshold = 890mA typ
1	1	0	1	X	X	X	X	Dynamic current limit NOT selected
1	1	0	0	X	X	X		Dynamic current limit selected
1	1	0	X	0	X	X	X	SELVTOP H/W pin Enabled
1	1	0	X	1	X	X	X	SELVTOP H/W pin Disabled

NOTE: X indicates "Read Only" and is a "Don't Care" for the Write mode.

TABLE 18. CONTROL REGISTER SR8 CONFIGURATION

SR8H	SR8M	SR8L	EN2	X	X	VTOP2	VBOT2	FUNCTION
1	1	1	1	X	X	0	0	SR4 is selected
1	1	1	1	X	X	0	0	VSPEN2 = SELVTOP2 = 0, VOUT1 = 13V, VBOOST1 = 13V + VDROPP
1	1	1	1	X	X	0	1	VSPEN2 = SELVTOP2 = 0, VOUT1 = 14V, VBOOST1 = 14V + VDROPP
1	1	1	1	X	X	1	0	VSPEN2 = SELVTOP2 = 0, VOUT1 = 13V, VBOOST1 = 13V + VDROPP
1	1	1	1	X	X	1	1	VSPEN2 = SELVTOP2 = 0, VOUT1 = 14V, VBOOST1 = 14V + VDROPP
1	1	1	1	X	X	0	0	VSPEN2 = 0, SELVTOP2 = 1, VOUT1 = 18V, VBOOST1 = 18V + VDROPP
1	1	1	1	X	X	0	1	VSPEN2 = 0, SELVTOP2 = 1, VOUT1 = 18V, VBOOST1 = 18V + VDROPP
1	1	1	1	X	X	1	0	VSPEN2 = 0, SELVTOP2 = 1, VOUT1 = 19V, VBOOST1 = 19V + VDROPP
1	1	1	1	X	X	1	1	VSPEN2 = 0, SELVTOP2 = 1, VOUT1 = 19V, VBOOST1 = 19V + VDROPP
1	1	1	1	X	X	0	0	VSPEN2 = 1, SELVTOP2 = X VOUT1 = 13V, VBOOST1 = 13V + VDROPP
1	1	1	1	X	X	0	1	VSPEN2 = 1, SELVTOP2 = X VOUT1 = 14V, VBOOST1 = 14V + VDROPP
1	1	1	1	X	X	1	0	VSPEN2 = 1, SELVTOP2 = X VOUT1 = 18V, VBOOST1 = 18V + VDROPP
1	1	1	1	X	X	1	1	VSPEN2 = 1, SELVTOP2 = X VOUT1 = 19V, VBOOST1 = 19V + VDROPP
1	1	1	0	X	X	X	X	PWM and Linear for Channel 1 disabled

NOTE: X indicates "Read Only" and is a "Don't Care" for the Write mode.

Received Data (I²C bus READ MODE)

The ISL6422B can provide to the master a copy of the system register information via the I²C bus in read mode. The read mode is Master activated by sending the chip address with R/W bit set to 1. At the following Master generated clock bits, the ISL6422B issues a byte on the SDA data bus line (MSB transmitted first).

At the ninth clock bit the MCU master can:

- Acknowledge the reception, starting in this way the transmission of another byte from the ISL6422B.
- Not acknowledge, stopping the read mode communication.

While the whole register is read back by the microprocessor, the read-only bits, OUC1, OUC2 - Over or Undercurrent bit,

UV1, UV2 - Over or Undervoltage bit, TPR1, TPR2 - Tone present bit, OTF - Over-temperature fault bit convey diagnostic information about the ISL6422B.

Power-On I²C Interface Reset

The I²C interface built into the ISL6422B is automatically reset at power-on. The I²C interface block will receive a Power OK logic signal from the UVLO circuit. This signal will go HIGH when chip power is OK. As long as this signal is LOW, the interface will not respond to any I²C commands and the system register SR1 and SR2 are initialized to all zeros, thus keeping the power blocks disabled. Once the V_{CC} rises above UVLO, the POWER OK signal given to the I²C interface block will be HIGH, the I²C

interface becomes operative and the SRs can be configured by the main microprocessor. About 400mV of hysteresis is provided in the UVLO threshold to avoid false triggering of the Power-On reset circuit. (I²C comes up with EN = 0; EN goes HIGH at the same time as (or later than) all other I²C data for that PWM becomes valid).

ADDRESS Pin

Connecting this pin to GND the chip I²C interface address is 0001000, but, it is possible to choose between four different addresses simply by setting this pin at one of the four fixed voltage levels, as shown in Table 19.

TABLE 19. ADDRESS PIN CHARACTERISTICS

V _{ADDR}	ADDR1	ADDR0
V _{ADDR-1} "0001000"	0	0
V _{ADDR-2} "0001001"	0	1
V _{ADDR-3} "0001010"	1	0
V _{ADDR-4} "0001011"	1	1

I²C Electrical Characteristics

TABLE 20. I²C SPECIFICATIONS

PARAMETER	TEST CONDITION	MIN	TYP	MAX
Input Logic High, VIH	SDA, SCL	2.0V		
Input Logic Low, VIL	SDA, SCL			0.8V
Input Logic Current, IIL	SDA, SCL; 0.4V < V _{DD} < 3.3V			10μA
Input Hysteresis	SDA, SCL	165mV	200mV	235mV
SCL Clock Frequency		0	100kHz	400kHz

I²C Bit Description

TABLE 21.

BIT NAME	DESCRIPTION
EN1, EN2	ENable output for Channels 1 and 2
VTOP1, VTOP2	Voltage TOP Select ie 18V/19V for Channels 1 and 2
VBOT1, VBOT2	Voltage BOTtom Select, i.e. 13V/14V for Channels 1 and 2
ENT1, ENT2	ENable Tone for Channels 1 and 2
MSEL1, MSEL2	Modulation SElect for Channels 1 and 2
TFR1, TFR2	Tone Frequency and Rise time select for Channels 1 and 2
DCL1, DCL2	Dynamic Current Limit select for Channels 1 and 2
VSPEN1, VSPEN2	Voltage Select Pin ENable for Channels 1 and 2
ISELH1, SELH2 and ISELL1, ISELL2, ISEL1R, ISEL2R	Current limit "I" SElect High and Low bits for Channels 1 and 2
OTF	Over-Temperature Fault bit
CABF1, CABF2	CABle Fault or open status bit for Channels 1 and 2
OUVF1, OUVF2	Over and Undervoltage Fault status bit for Channels 1 and 2
OLF1, OLF2	Over Load Fault status bit for Channels 1 and 2
BCF1, BCF2	Backward Current Fault bit for Channels 1 and 2
TTH1, TTH2	Tone THreshold is the OR of the signal pin TXT1, TXT2

Revision History

The revision history provided is for informational purposes only and is believed to be accurate, but not warranted. Please go to the web to make sure that you have the latest revision.

DATE	REVISION	CHANGE
September 8, 2015	FN6486.2	Added Rev History beginning with Rev 2. Added About Intersil Verbiage Updated Ordering Information on page 1

About Intersil

Intersil Corporation is a leading provider of innovative power management and precision analog solutions. The company's products address some of the largest markets within the industrial and infrastructure, mobile computing and high-end consumer markets.

For the most updated datasheet, application notes, related documentation and related parts, please see the respective product information page found at www.intersil.com.

You may report errors or suggestions for improving this datasheet by visiting www.intersil.com/ask.

Reliability reports are also available from our website at www.intersil.com/support

© Copyright Intersil Americas LLC 2007-2015. All Rights Reserved.
All trademarks and registered trademarks are the property of their respective owners.

For additional products, see www.intersil.com/en/products.html

Intersil products are manufactured, assembled and tested utilizing ISO9001 quality systems as noted in the quality certifications found at www.intersil.com/en/support/qualandreliability.html

Intersil products are sold by description only. Intersil may modify the circuit design and/or specifications of products at any time without notice, provided that such modification does not, in Intersil's sole judgment, affect the form, fit or function of the product. Accordingly, the reader is cautioned to verify that datasheets are current before placing orders. Information furnished by Intersil is believed to be accurate and reliable. However, no responsibility is assumed by Intersil or its subsidiaries for its use; nor for any infringements of patents or other rights of third parties which may result from its use. No license is granted by implication or otherwise under any patent or patent rights of Intersil or its subsidiaries.

For information regarding Intersil Corporation and its products, see www.intersil.com

Package Outline Drawing

L40.6x6

40 LEAD QUAD FLAT NO-LEAD PLASTIC PACKAGE

Rev 3, 10/06

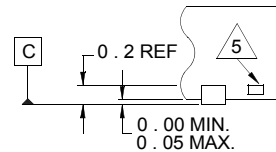
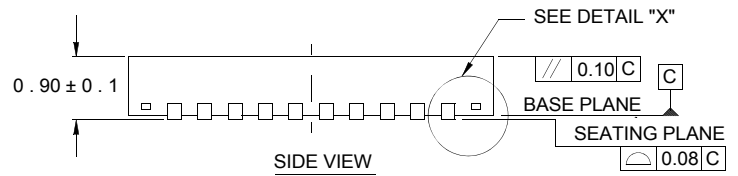
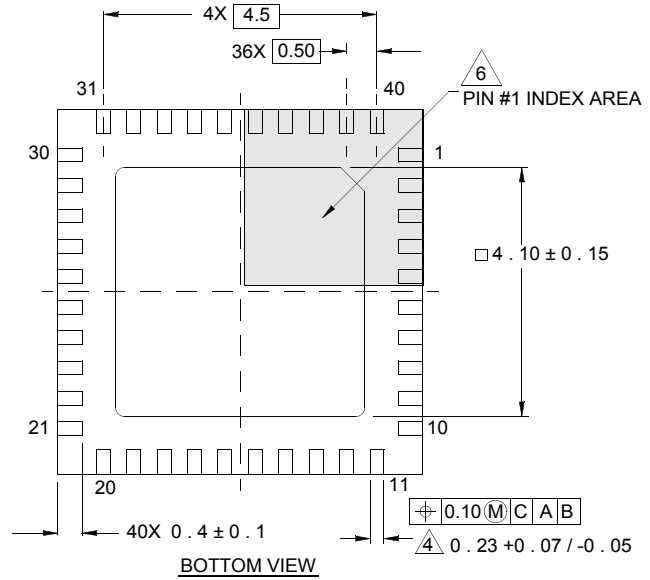
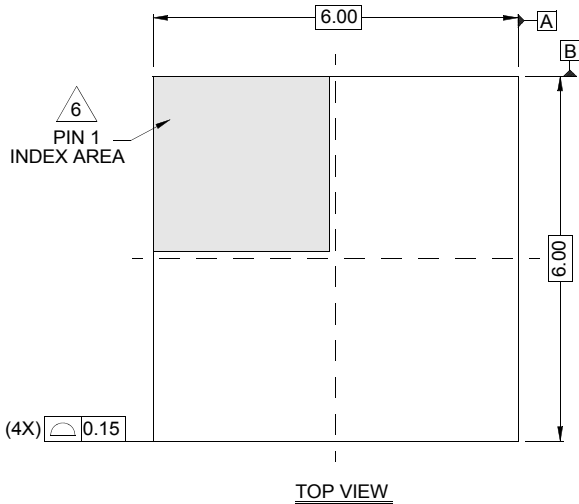

NOTES:

1. Dimensions are in millimeters.
Dimensions in () for Reference Only.
2. Dimensioning and tolerancing conform to AMSE Y14.5m-1994.
3. Unless otherwise specified, tolerance : Decimal ± 0.05
4. Dimension b applies to the metallized terminal and is measured between 0.15mm and 0.30mm from the terminal tip.
5. Tiebar shown (if present) is a non-functional feature.
6. The configuration of the pin #1 identifier is optional, but must be located within the zone indicated. The pin #1 identifier may be either a mold or mark feature.

Thin Shrink Small Outline Exposed Pad Plastic Packages (EPTSSOP)

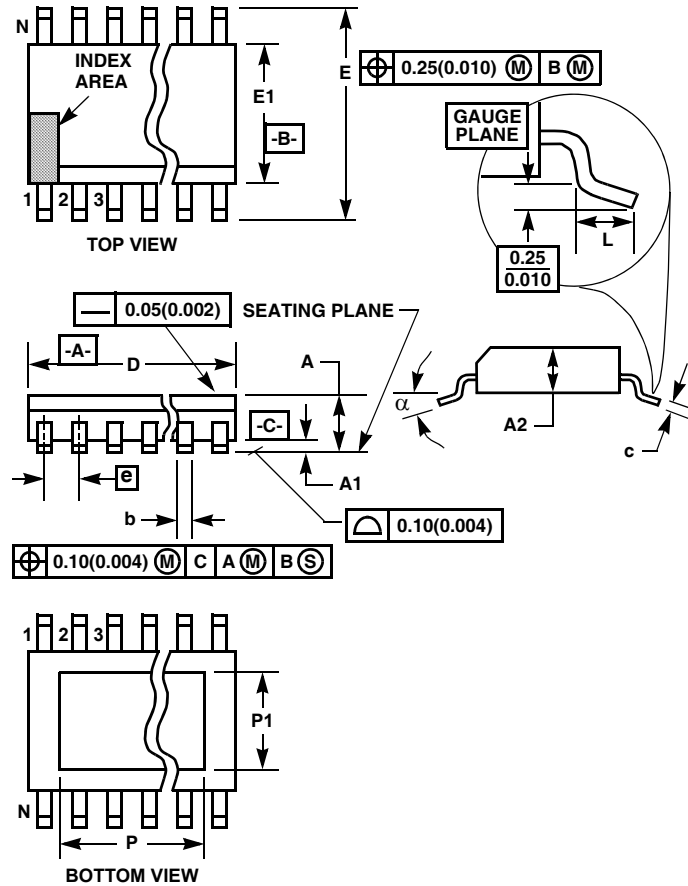

M38.173B

38 LEAD THIN SHRINK SMALL OUTLINE PLASTIC PACKAGE

SYMBOL	INCHES		MILLIMETERS		NOTES
	MIN	MAX	MIN	MAX	
A	-	0.047	-	1.20	-
A1	0.002	0.006	0.05	0.15	-
A2	0.031	0.051	0.80	1.05	-
b	0.0075	0.0106	0.17	0.27	9
c	0.0035	0.0079	0.09	0.20	-
D	0.378	0.386	9.60	9.80	3
E1	0.169	0.177	4.30	4.50	4
e	0.0197 BSC		0.500 BSC		-
E	0.246	0.256	6.25	6.50	-
L	0.0177	0.0295	0.45	0.75	6
N	38		38		7
alpha	0°	8°	0°	8°	-
P	-	0.256	-	6.5	11
P1	-	0.126	-	3.2	11

Rev. 0 9/06

NOTES:

1. These package dimensions are within allowable dimensions of JEDEC MO-153-BD-1, Issue F.
2. Dimensioning and tolerancing per ANSI Y14.5M-1982.
3. Dimension "D" does not include mold flash, protrusions or gate burrs. Mold flash, protrusion and gate burrs shall not exceed 0.15mm (0.006 inch) per side.
4. Dimension "E1" does not include interlead flash or protrusions. Interlead flash and protrusions shall not exceed 0.15mm (0.006 inch) per side.
5. The chamfer on the body is optional. If it is not present, a visual index feature must be located within the crosshatched area.
6. "L" is the length of terminal for soldering to a substrate.
7. "N" is the number of terminal positions.
8. Terminal numbers are shown for reference only.
9. Dimension "b" does not include dambar protrusion. Allowable dambar protrusion shall be 0.08mm (0.003 inch) total in excess of "b" dimension at maximum material condition. Minimum space between protrusion and adjacent lead is 0.07mm (0.0027 inch).
10. Controlling dimension: MILLIMETER. Converted inch dimensions are not necessarily exact. (Angles in degrees)
11. Dimensions "P" and "P1" are thermal and/or electrical enhanced variations. Values shown are maximum size of exposed pad within lead count and body size.