

## ISL6263AEVAL1Z, ISL6263BEVAL1Z

### Evaluation Boards

AN1486  
Rev 0.00  
August 11, 2009

The ISL6263AEVAL1Z and ISL6263BEVAL1Z evaluation boards demonstrate the performance of the ISL6263A and ISL6263B respectively. The ISL6263A and ISL6263B are single-phase synchronous buck PWM controllers, which feature Intersil's Robust Ripple Regulator (R<sup>3</sup>) technology. The evaluation board design criteria is located in Table 1. An on-board dynamic-load generator is included for evaluating the transient-load response. The dynamic-load applies a 2.5ms pulse of 200mΩ across V<sub>OUT</sub> and GND every 30ms.

### What's Inside

Contents of this document include:

- Recommended Test Equipment
- Interface Connections
- Switch Descriptions
- Jumper Descriptions
- Test Point Descriptions
- Schematic
- Bill of Materials
- Silkscreen Plots
- Board Layout Plots

**TABLE 1. EVALUATION BOARD DESIGN CRITERIA**

PARAMETER	VALUE	UNITS
VIN	5 to 25	V <sub>DC</sub>
VOUT	0.41200 to 1.28750	V <sub>DC</sub>
DROOP	8	mΩ
FULL-LOAD	12	A <sub>DC</sub>
PWM FREQUENCY	300	kHz
OCP	~15.5	A <sub>DC</sub>

### Recommended Equipment

- (QTY 1) Adjustable 25V, 5A Power Supply
- (QTY 1) Fixed 12V, 100mA Power Supply
- (QTY 1) Fixed 5V, 100mA Power Supply
- (QTY 1) Adjustable 20A Constant Current Electronic Load
- (QTY 1) Digital Multi-Meter
- (QTY 1) Four-Channel Oscilloscope

### Interface Connections

- VIN: Input voltage to the power stage of the converter
  - J6: VIN positive power input
  - P37: VIN positive voltage sense
  - J5: VIN return power input
  - P38: VIN return voltage sense
- VOUT: Regulated output voltage from the converter
  - J14: VOUT positive power output
  - P5: VOUT positive voltage sense
  - J13: VOUT return power output
  - P9: VOUT return voltage sense
- 5V: +5V input voltage for VCC, PVCC, PGOOD-LED and pull-up voltage rail
  - J1: 5V positive input
  - J2: 5V return input
- 3.3V: +3.3V input voltage for auxiliary circuits
  - J3: 3.3V positive input
  - J4: 3.3V return input
- +12V: +12V input voltage for the dynamic-load generator
  - J11: 12V positive input
  - J12: 12V return input

### Jumper Descriptions

- J7 (SRIP) — Selects the logic state of the AF\_EN pin
  - Install shunt jumper across pins 1 and 2 for HIGH
  - Install shunt jumper across pins 2 and 3 for LOW (default)
- J9 — PGOOD circuit 5V input
  - Shunt jumper installed during normal operation (default)
  - Shunt jumper can be removed during efficiency tests
- J10 — Selects the logic state of the FDE pin
  - Install shunt jumper across pins 1 and 2 for HIGH
  - Install shunt jumper across pins 2 and 3 for LOW (default)
- J16 — VDD input current measurement port
  - Shunt jumper installed during normal operation (default)
  - Shunt jumper replaced by DMM to measure VDD bias current
- J17 — VDD and PVCC input current measurement port
  - Shunt jumper installed during normal operation (default)
  - Shunt jumper replaced by DMM to measure VDD bias current and PVCC bias current
- J18 — PGOOD and pull-up supply selection
  - Install shunt jumper across pins 1 and 2 for 5V (default)
  - Install shunt jumper across pins 2 and 3 for 3.3V (3.3V power supply should be connected to J3 and J4)

## Switch Descriptions

- S1 — VIDs inputs (default <00000>)
- S4 — VR\_ON (enable)
  - OFF — Converter is not enabled (default)
  - ON — Converter is enabled
- S5 — Transient load generator
  - OFF — Transient load is not enabled (default)
  - ON — Transient load is enabled

## Test Point Descriptions

- PMON
  - — IMON test point for ISL6263A
  - — PMON test point for ISL6263B
- P1 (SRIP) — AF\_EN
- P3 — DROOP
- P4 — COMP
- P5 — VOUT positive voltage sense
- P6 — PGOOD
- P7 — OCSET
- P8 — VW
- P9 — VOUT return voltage sense
- P11 — VSEN
- P12 — FB
- P13 — VSS
- P14 — SOFT
- P16 — FDE
- P17 — VDIFF after R<sub>30</sub> network analyzer port
- P20 — VR\_ON
- P21 — VDIFF
- P22 (VCCP) — VO
- P26 — VSS
- P29 — VIN
- P30 — VSUM
- P32 — VDD
- P34 (+5V) — PVCC
- P35 — UGATE
- P36 — LGATE
- P37 — VIN positive voltage sense
- P38 — VIN return voltage sense

- VIDs Test Points:

TABLE 2. VID TEST POINT DESCRIPTIONS

TEST POINT (SILKSCREEN)	FUNCTION DESCRIPTION
P25	VID4
P27	VID3
P28	VID2
P31	VID1
P33	VID0

- J20 — PHASE (for oscilloscope probe)
- J22 — VOUT positive voltage sense to VOUT return voltage sense (for oscilloscope probe)
- J23 — Transient load (for oscilloscope probe)

## Resistor Current Sense Configuration

The evaluation board is pre-configured with inductor DCR current sense. It also provides the option of resistor current sense for more precise overcurrent protection and current monitor. Follow the following procedure to configure the resistor current sense:

- Step 1:* Replace R<sub>60</sub> with the current sense shunt resistor
- Step 2:* Remove R<sub>50</sub> and R<sub>53</sub>
- Step 3:* Place R<sub>52</sub> and R<sub>54</sub> with 0Ω resistors
- Step 4:* Follow the datasheet to configure other resistor current sense and overcurrent protection components.

## Dynamic Load Generator

The evaluation board provides an on-board dynamic load generator for evaluating the transient-load response, which is controlled by switch S4. The dynamic load generator applies a 2.5ms pulse load across V<sub>OUT</sub> and GND. The transient load slew-rate can be trimmed by adjusting the resistor R<sub>74</sub> for the rising edge, and resistor R<sub>73</sub> for the falling edge. A +12V power supply is needed to power the dynamic load generator.

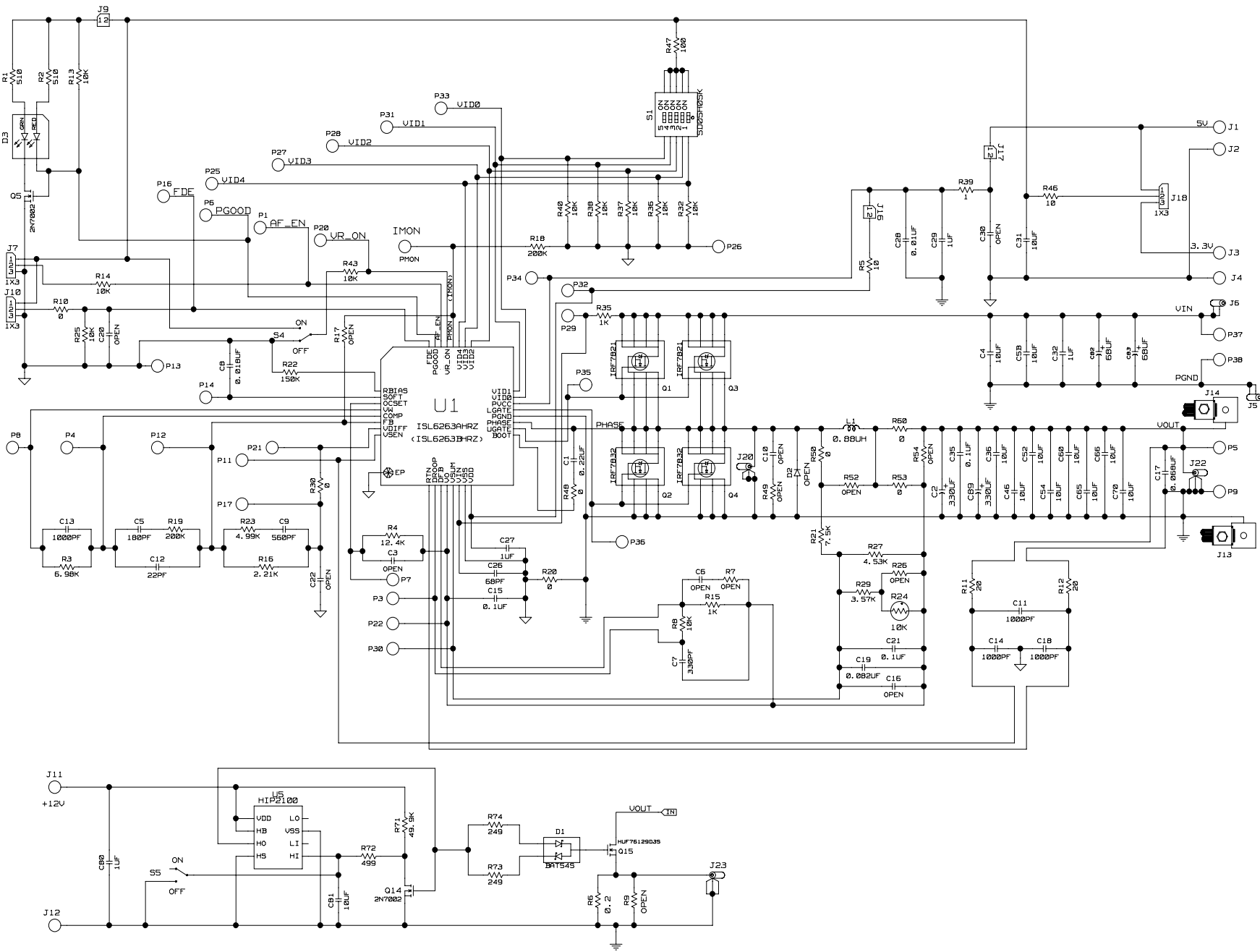

FIGURE 1. ISL6263AEVAL1Z AND ISL6263BEVAL1Z EVALUATION BOARDS SCHEMATIC

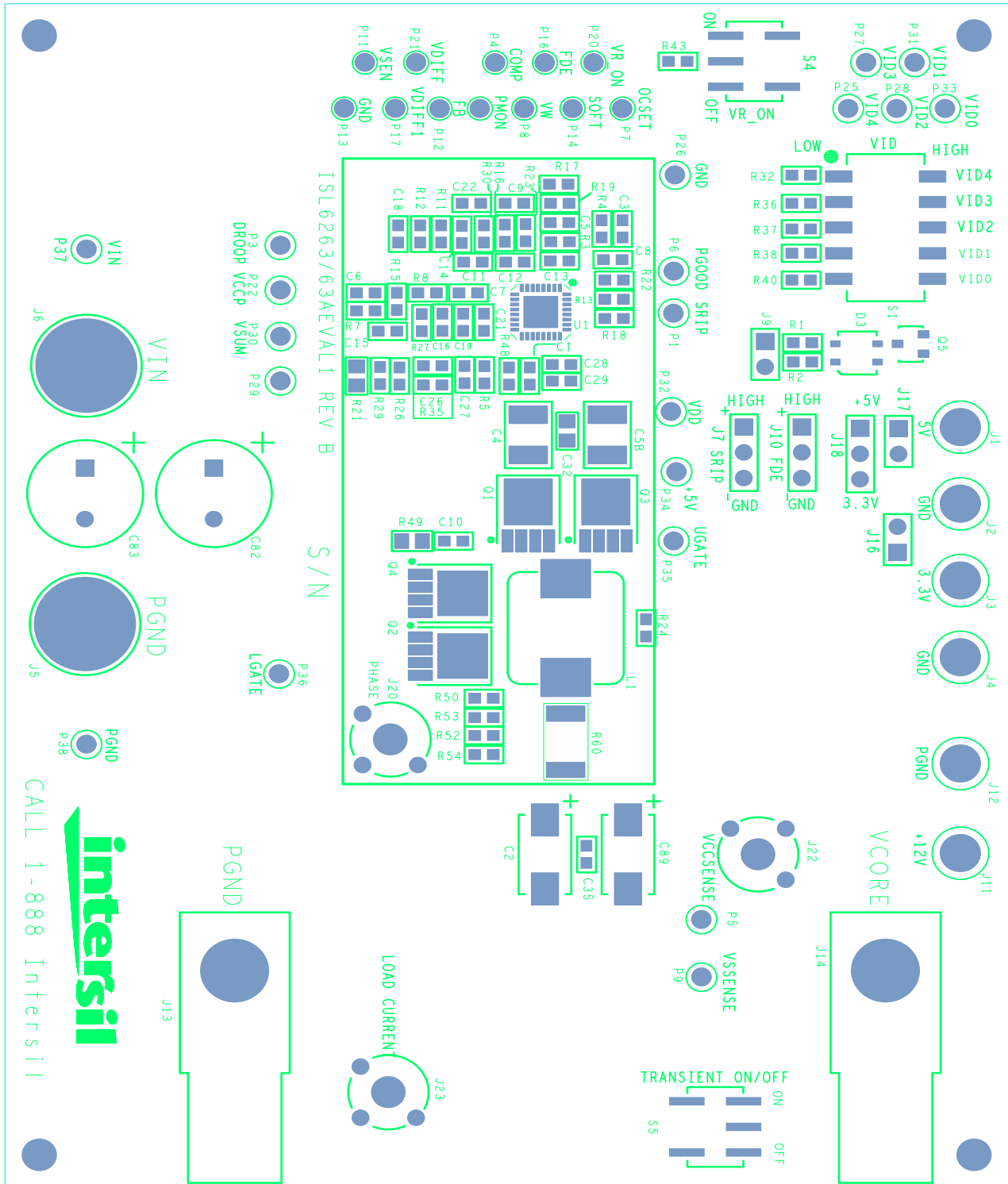

FIGURE 2. ISL6263AEVAL1Z AND ISL6263BEVAL1Z EVALUATION BOARDS PCB TOP SILKSREEN

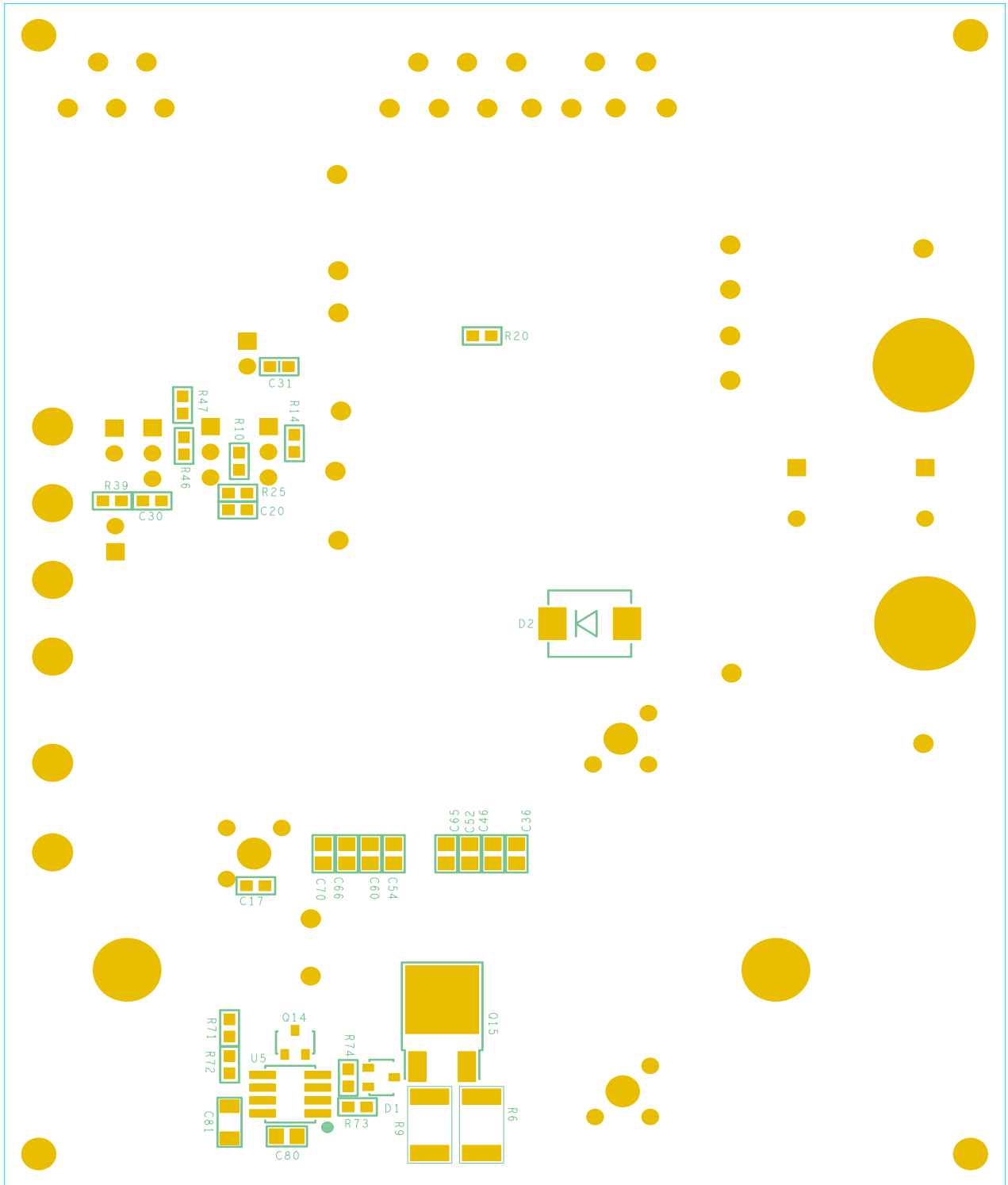

FIGURE 3. ISL6263AEVAL1Z and ISL6263BEVAL1Z EVALUATION BOARDS PCB BOTTOM SILKSCREEN

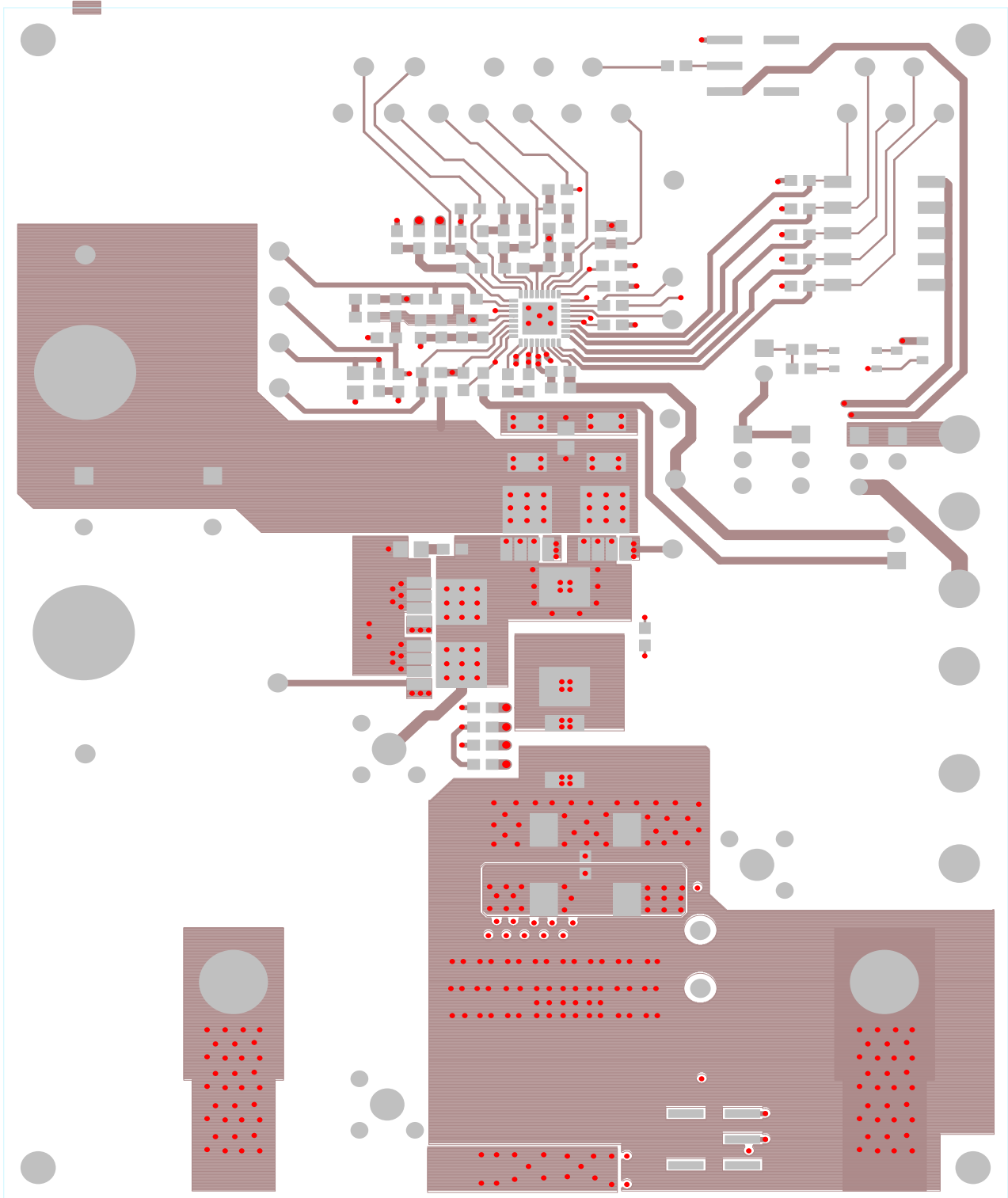

FIGURE 4. ISL6263AEVAL1Z and ISL6263BEVAL1Z EVALUATION BOARDS PCB TOP ETCH

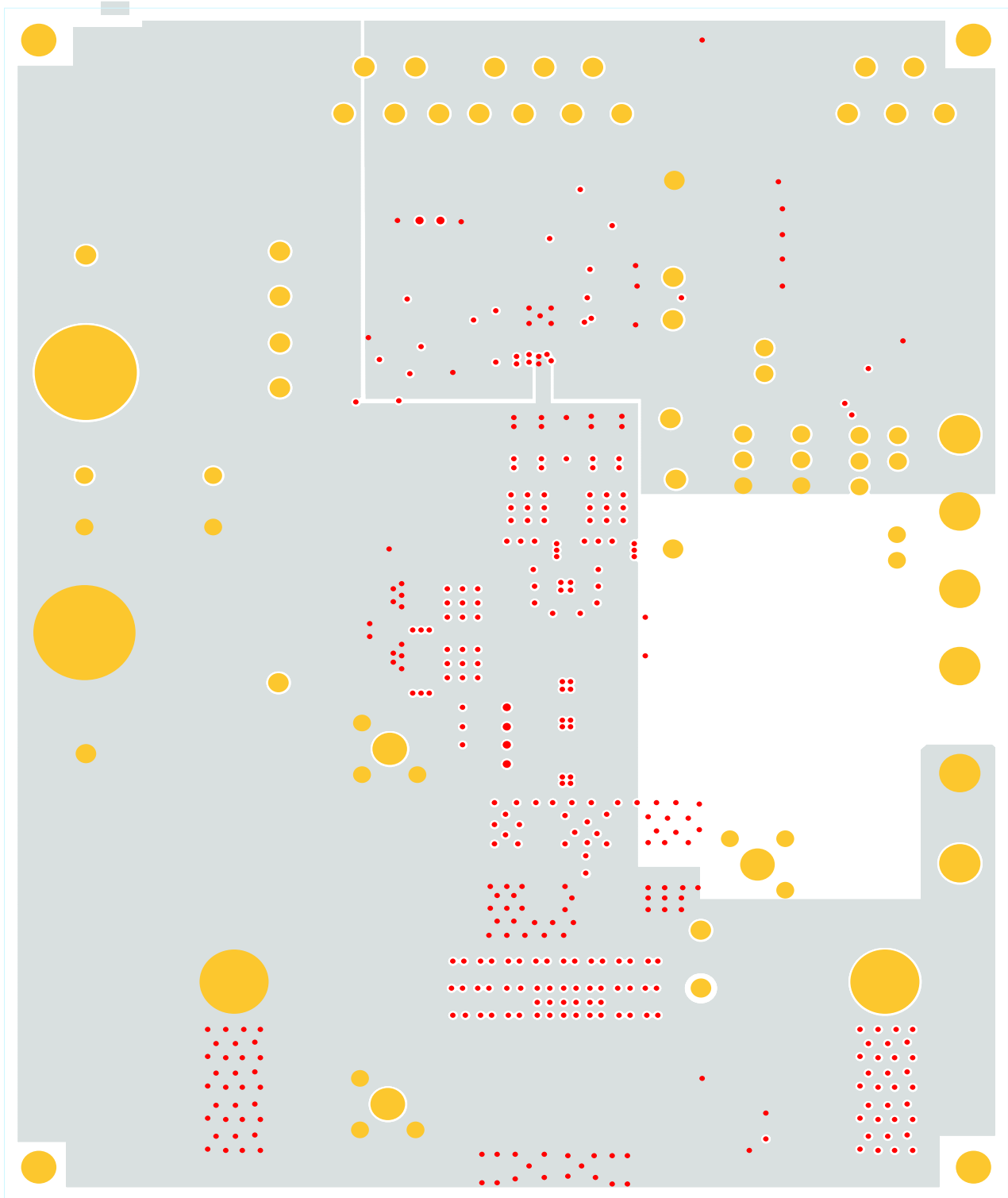

FIGURE 5. ISL6263AEVAL1Z and ISL6263BEVAL1Z EVALUATION BOARDS LAYER 2 ETCH

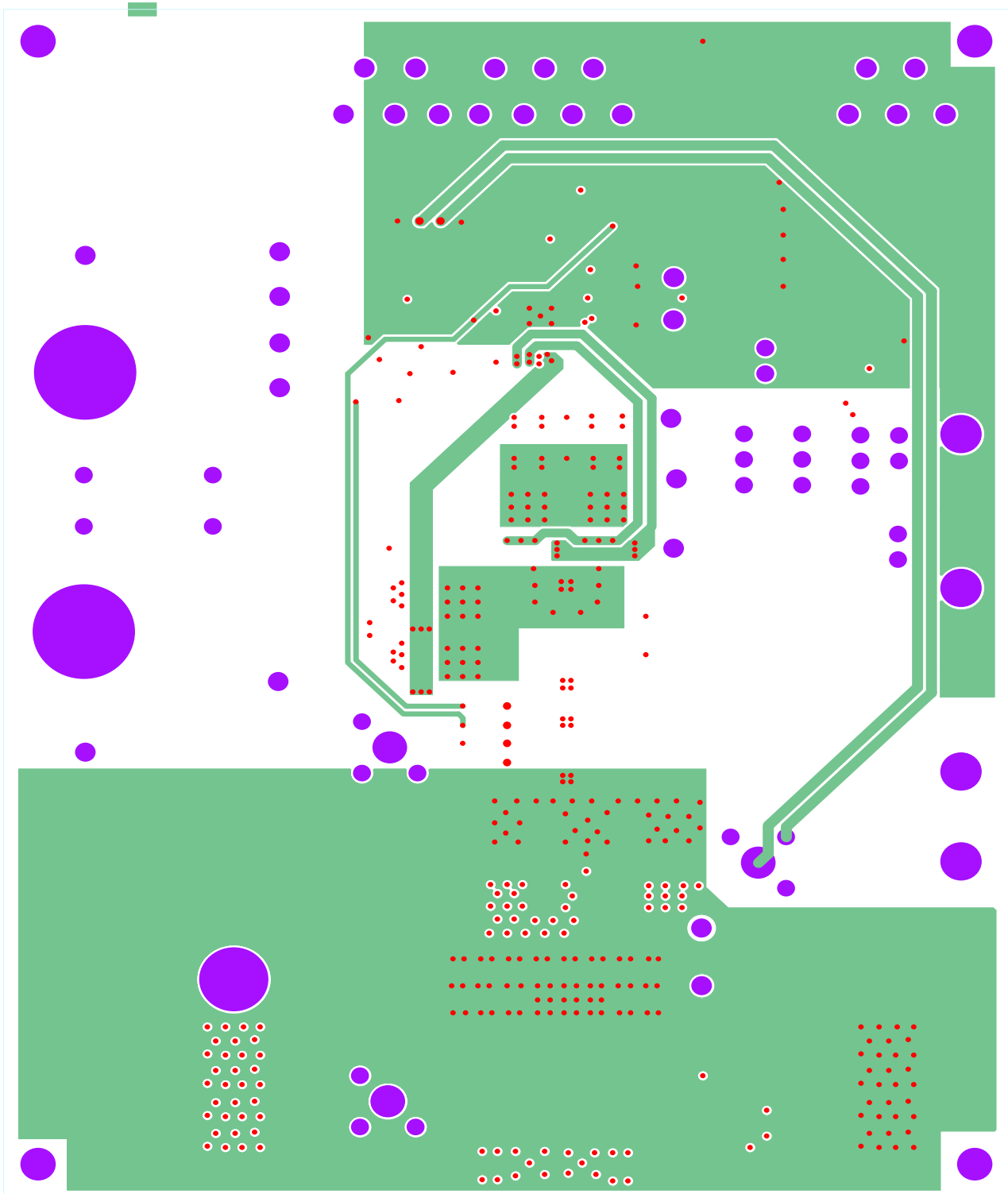

FIGURE 6. ISL6263AEVAL1Z and ISL6263BEVAL1Z EVALUATION BOARDS PCB LAYER 3 ETCH



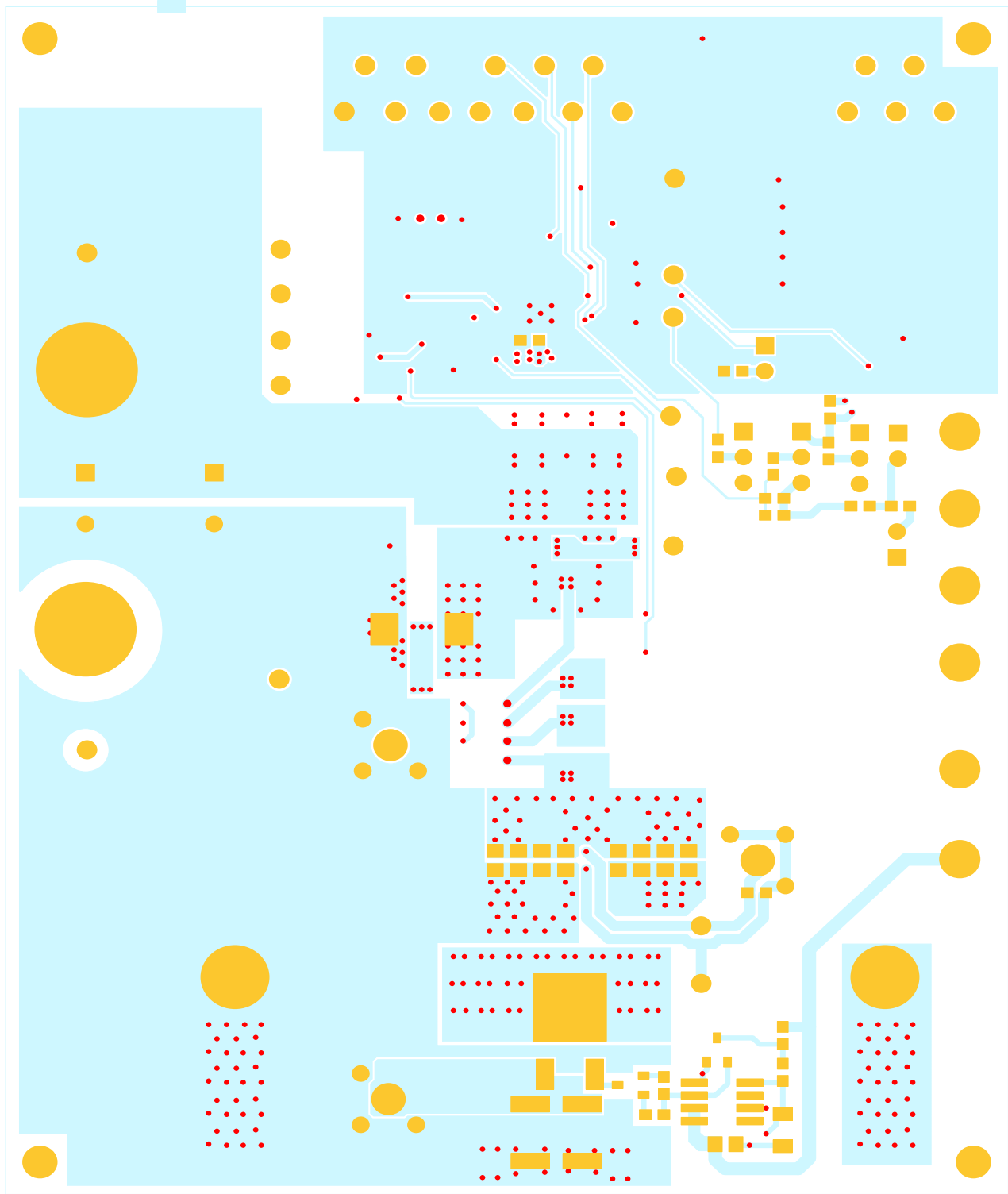

FIGURE 7. ISL6263AEVAL1Z AND ISL6263BEVAL1Z EVALUATION BOARDS PCB BOTTOM ETCH

**Bill of Materials**

ISL6263AEVAL1Z and ISL6263BEVAL1Z evaluation boards use the same PCB and schematic, thus the same bill of materials except for the controller.

NO.	REFERENCE	QTY	DESCRIPTION	MFG NAME	MFG PART NUMBER
1	C82, C83	2	CAP, RADIAL, 68 $\mu$ F, 100V, 20%, ALUM.ELECTROLYTIC	PANASONIC	EEU-FC2A680L
2	C11, C13, C14, C18	4	CAP, SMD, 0603, 1000pF, 16V, 10%, X7R	GENERIC	NA
3	C28	1	CAP, SMD, 0603, 0.01 $\mu$ F, 16V, 10%, X7R	GENERIC	NA
4	C15, C21, C35	3	CAP, SMD, 0603, 0.1 $\mu$ F, 25V, 10%, X7R	GENERIC	NA
5	C27, C29	2	CAP, SMD, 0603, 1 $\mu$ F, 6.3V, 10%, X5R	GENERIC	NA
6	C5	1	CAP, SMD, 0603, 180pF, 10V, 10%, X7R	GENERIC	NA
7	C1	1	CAP, SMD, 0603, 0.22 $\mu$ F, 25V, 20%, X7R	GENERIC	NA
8	C7	1	CAP, SMD, 0603, 330pF, 10V, 5%, NPO	GENERIC	NA
9	C9	1	CAP, SMD, 0603, 560pF, 10V, 10%, X7R	GENERIC	NA
10	C12	1	CAP, SMD, 0603, 22pF, 10V, 5%, NPO	GENERIC	NA
11	C26	1	CAP, SMD, 0603, 68pF, 50V, 5%, NPO	GENERIC	NA
12	C17	1	CAP, SMD, 0603, 0.068 $\mu$ F, 16V, 10%, X7R	GENERIC	NA
13	C19	1	CAP, SMD, 0603, 0.082 $\mu$ F, 16V, 10%, X7R	GENERIC	NA
14	C8	1	CAP, SMD, 0603, 0.018 $\mu$ F, 10V, 10%, X7R	GENERIC	NA
15	C32, C80	2	CAP, SMD, 0805, 1.0 $\mu$ F, 25V, 10%, X7R	GENERIC	NA
16	C31, C36, C46, C52, C54, C60, C65, C66, C70	9	CAP, SMD, 0805, 10 $\mu$ F, 6.3V, 10%, X5R	GENERIC	NA
17	C81	1	CAP, SMD, 1206, 10 $\mu$ F, 16V, 20%, X5R	GENERIC	NA
18	C4, C5B	2	CAP, SMD, 1812, 10 $\mu$ F, 25V, 10%, X5R	GENERIC	NA
19	C2, C89	2	CAP, SMD, 330 $\mu$ F, 2V, 20%, SP-CAP	PANASONIC	EEF-SX0D331XR
20	L1	1	INDUCTOR, SMD, 11.5X10, 0.88 $\mu$ H, 20%, 17.4A	NEC/TOKIN	MPC1040LR88
21	U5	1	IC-HI FREQ BRIDGE DRIVER, SO8, 100V	INTERSIL	HIP2100IB
22	U1	1	PWM CONTROLLER, 32P, QFN, 5x5	INTERSIL	ISL6263AHRZ or ISL6263BHRZ
23	R24	1	NTC, SMD, 0603, 10k, 1/10W, 5%, B VALUE = 4201k to 4300k	PANASONIC	ERT-J1VR103J
24	Q5, Q14	2	MOSFET, N-CH, SOT23, 60V, 115mA	MOTOROLA	2N7002LT1
25	Q15	1	MOSFET, N-CH, TO-252AA, 30V, 16m $\Omega$	FAIRCHILD	HUF76129D3S
26	Q1	1	MOSFET, N-CH, SO8, 30V, 9.1m $\Omega$	IR	IRF7821
27	Q2, Q4	2	MOSFET, N-CH, SO8, 30V, 4.0m $\Omega$	IR	IRF7832
28	R39	1	RES, SMD, 0603, 1 $\Omega$ , 1/10W, 1%	GENERIC	NA
29	R5, R46	2	RES, SMD, 0603, 10 $\Omega$ , 1/10W, 1%	GENERIC	NA
30	R11, R12	2	RES, SMD, 0603, 20 $\Omega$ , 1/16W, 1%	GENERIC	NA
31	R10, R20, R30, R48, R50, R53	6	RES, SMD, 0603, 0 $\Omega$ , 1/16W	GENERIC	NA
32	R47	1	RES, SMD, 0603, 100 $\Omega$ , 1/10W, 1%	GENERIC	NA
33	R15, R35	2	RES, SMD, 0603, 1k, 1/10W, 1%	GENERIC	NA
34	R8, R13, R14, R25, R32, R36, R37, R38, R40, R43	10	RES, SMD, 0603, 10k, 1/10W, 1%,	GENERIC	NA

**Bill of Materials**

ISL6263AEVAL1Z and ISL6263BEVAL1Z evaluation boards use the same PCB and schematic, thus the same bill of materials except for the controller. (Continued)

NO.	REFERENCE	QTY	DESCRIPTION	MFG NAME	MFG PART NUMBER
35	R4	1	RES, SMD, 0603, 12.4k, 1/16W, 1%	GENERIC	NA
36	R22	1	RES, SMD, 0603, 150k, 1/16W, 1%	GENERIC	NA
37	R18, R19	2	RES, SMD, 0603, 200k, 1/16W, 1%	GENERIC	NA
38	R16	1	RES, SMD, 0603, 2.21k, 1/16W, 1%	GENERIC	NA
39	R73, R74	2	RES, SMD, 0603, 249 $\Omega$ , 1/16W, 1%	GENERIC	NA
40	R29	1	RES, SMD, 0603, 3.57k, 1/16W, 1%	GENERIC	NA
41	R27	1	RES, SMD, 0603, 4.53k, 1/16W, 1%	GENERIC	NA
42	R72	1	RES, SMD, 0603, 499 $\Omega$ , 1/16W, 1%	GENERIC	NA
43	R23	1	RES, SMD, 0603, 4.99k, 1/16W, 1%	GENERIC	NA
44	R71	1	RES, SMD, 0603, 49.9k, 1/16W, 1%	GENERIC	NA
45	R1, R2	2	RES, SMD, 0603, 510 $\Omega$ , 1/16W, 5%	GENERIC	NA
46	R3	1	RES, SMD, 0603, 6.98k, 1/16W, 1%	GENERIC	NA
47	R21	1	RES, SMD, 0603, 7.5k, 1/16W, 1%	GENERIC	NA
48	R60	1	RES, SMD, 2512, 0 $\Omega$ , 1W, 5%	GENERIC	NA
49	R6	1	RES, SMD, 2512, 0.2 $\Omega$ , 1W, 1%	DALE	WSL-2512-R200F
50	S4, S5	2	SWITCH-TOGGLE, SMD, 1P, SPST	C&K COMPONENTS	GT11MSCKE
51	S1	1	SWITCH-DIP, SMD, DIP, 5P, SLIDE, SPST	C&K COMPONENTS	SD05H0SK
52	D1	1	SCHOTTKY, SMD, SOT23, 3P, 30V, 200mA, DUAL DIODE	FAIRCHILD	BAT54S
53	D3	2	LED, SMD, 3x2.5mm, 4P, RED/GREEN, 12/20MCD, 2V	LUMEX	SSL-LXA3025IGC-TR
54	C3, C6, C10, C16, C20, C22, C30, R7, R9, R17, R26, R49, R52, R54, D2, Q3	16	OPEN		

## Notice

1. Descriptions of circuits, software and other related information in this document are provided only to illustrate the operation of semiconductor products and application examples. You are fully responsible for the incorporation or any other use of the circuits, software, and information in the design of your product or system. Renesas Electronics disclaims any and all liability for any losses and damages incurred by you or third parties arising from the use of these circuits, software, or information.
2. Renesas Electronics hereby expressly disclaims any warranties against and liability for infringement or any other claims involving patents, copyrights, or other intellectual property rights of third parties, by or arising from the use of Renesas Electronics products or technical information described in this document, including but not limited to, the product data, drawings, charts, programs, algorithms, and application examples.
3. No license, express, implied or otherwise, is granted hereby under any patents, copyrights or other intellectual property rights of Renesas Electronics or others.
4. You shall not alter, modify, copy, or reverse engineer any Renesas Electronics product, whether in whole or in part. Renesas Electronics disclaims any and all liability for any losses or damages incurred by you or third parties arising from such alteration, modification, copying or reverse engineering.
5. Renesas Electronics products are classified according to the following two quality grades: "Standard" and "High Quality". The intended applications for each Renesas Electronics product depends on the product's quality grade, as indicated below.  
"Standard": Computers; office equipment; communications equipment; test and measurement equipment; audio and visual equipment; home electronic appliances; machine tools; personal electronic equipment; industrial robots; etc.  
"High Quality": Transportation equipment (automobiles, trains, ships, etc.); traffic control (traffic lights); large-scale communication equipment; key financial terminal systems; safety control equipment; etc.  
Unless expressly designated as a high reliability product or a product for harsh environments in a Renesas Electronics data sheet or other Renesas Electronics document, Renesas Electronics products are not intended or authorized for use in products or systems that may pose a direct threat to human life or bodily injury (artificial life support devices or systems; surgical implantations; etc.), or may cause serious property damage (space system; undersea repeaters; nuclear power control systems; aircraft control systems; key plant systems; military equipment; etc.). Renesas Electronics disclaims any and all liability for any damages or losses incurred by you or any third parties arising from the use of any Renesas Electronics product that is inconsistent with any Renesas Electronics data sheet, user's manual or other Renesas Electronics document.
6. When using Renesas Electronics products, refer to the latest product information (data sheets, user's manuals, application notes, "General Notes for Handling and Using Semiconductor Devices" in the reliability handbook, etc.), and ensure that usage conditions are within the ranges specified by Renesas Electronics with respect to maximum ratings, operating power supply voltage range, heat dissipation characteristics, installation, etc. Renesas Electronics disclaims any and all liability for any malfunctions, failure or accident arising out of the use of Renesas Electronics products outside of such specified ranges.
7. Although Renesas Electronics endeavors to improve the quality and reliability of Renesas Electronics products, semiconductor products have specific characteristics, such as the occurrence of failure at a certain rate and malfunctions under certain use conditions. Unless designated as a high reliability product or a product for harsh environments in a Renesas Electronics data sheet or other Renesas Electronics document, Renesas Electronics products are not subject to radiation resistance design. You are responsible for implementing safety measures to guard against the possibility of bodily injury, injury or damage caused by fire, and/or danger to the public in the event of a failure or malfunction of Renesas Electronics products, such as safety design for hardware and software, including but not limited to redundancy, fire control and malfunction prevention, appropriate treatment for aging degradation or any other appropriate measures. Because the evaluation of microcomputer software alone is very difficult and impractical, you are responsible for evaluating the safety of the final products or systems manufactured by you.
8. Please contact a Renesas Electronics sales office for details as to environmental matters such as the environmental compatibility of each Renesas Electronics product. You are responsible for carefully and sufficiently investigating applicable laws and regulations that regulate the inclusion or use of controlled substances, including without limitation, the EU RoHS Directive, and using Renesas Electronics products in compliance with all these applicable laws and regulations. Renesas Electronics disclaims any and all liability for damages or losses occurring as a result of your noncompliance with applicable laws and regulations.
9. Renesas Electronics products and technologies shall not be used for or incorporated into any products or systems whose manufacture, use, or sale is prohibited under any applicable domestic or foreign laws or regulations. You shall comply with any applicable export control laws and regulations promulgated and administered by the governments of any countries asserting jurisdiction over the parties or transactions.
10. It is the responsibility of the buyer or distributor of Renesas Electronics products, or any other party who distributes, disposes of, or otherwise sells or transfers the product to a third party, to notify such third party in advance of the contents and conditions set forth in this document.
11. This document shall not be reprinted, reproduced or duplicated in any form, in whole or in part, without prior written consent of Renesas Electronics.
12. Please contact a Renesas Electronics sales office if you have any questions regarding the information contained in this document or Renesas Electronics products.  
(Note 1) "Renesas Electronics" as used in this document means Renesas Electronics Corporation and also includes its directly or indirectly controlled subsidiaries.  
(Note 2) "Renesas Electronics product(s)" means any product developed or manufactured by or for Renesas Electronics.

(Rev.4.0-1 November 2017)



### SALES OFFICES

Renesas Electronics Corporation

<http://www.renesas.com>

Refer to "<http://www.renesas.com/>" for the latest and detailed information.

**Renesas Electronics America Inc.**  
1001 Murphy Ranch Road, Milpitas, CA 95035, U.S.A.  
Tel: +1-408-432-8888, Fax: +1-408-434-5351

**Renesas Electronics Canada Limited**  
9251 Yonge Street, Suite 8309 Richmond Hill, Ontario Canada L4C 9T3  
Tel: +1-905-237-2004

**Renesas Electronics Europe Limited**  
Dukes Meadow, Millboard Road, Bourne End, Buckinghamshire, SL8 5FH, U.K.  
Tel: +44-1628-651-700, Fax: +44-1628-651-804

**Renesas Electronics Europe GmbH**  
Arcadiastrasse 10, 40472 Düsseldorf, Germany  
Tel: +49-211-6503-0, Fax: +49-211-6503-1327

**Renesas Electronics (China) Co., Ltd.**  
Room 1709 Quantum Plaza, No.27 ZhichunLu, Haidian District, Beijing, 100191 P. R. China  
Tel: +86-10-8235-1155, Fax: +86-10-8235-7679

**Renesas Electronics (Shanghai) Co., Ltd.**  
Unit 301, Tower A, Central Towers, 555 Langao Road, Putuo District, Shanghai, 200333 P. R. China  
Tel: +86-21-2226-0888, Fax: +86-21-2226-0999

**Renesas Electronics Hong Kong Limited**  
Unit 1601-1611, 16/F., Tower 2, Grand Century Place, 193 Prince Edward Road West, Mongkok, Kowloon, Hong Kong  
Tel: +852-2265-6688, Fax: +852-2886-9022

**Renesas Electronics Taiwan Co., Ltd.**  
13F, No. 363, Fu Shing North Road, Taipei 10543, Taiwan  
Tel: +886-2-8175-9600, Fax: +886-2-8175-9670

**Renesas Electronics Singapore Pte. Ltd.**  
80 Bendemeer Road, Unit #06-02 Hyflux Innovation Centre, Singapore 339949  
Tel: +65-6213-0200, Fax: +65-6213-0300

**Renesas Electronics Malaysia Sdn.Bhd.**  
Unit 1207, Block B, Menara Amcorp, Amcorp Trade Centre, No. 18, Jln Persiaran Barat, 46050 Petaling Jaya, Selangor Darul Ehsan, Malaysia  
Tel: +60-3-7955-9390, Fax: +60-3-7955-9510

**Renesas Electronics India Pvt. Ltd.**  
No.777C, 100 Feet Road, HAL 2nd Stage, Indiranagar, Bangalore 560 038, India  
Tel: +91-80-67208700, Fax: +91-80-67208777

**Renesas Electronics Korea Co., Ltd.**  
17F, KAMCO Yangjae Tower, 262, Gangnam-daero, Gangnam-gu, Seoul, 06265 Korea  
Tel: +82-2-558-3737, Fax: +82-2-558-5338