



Achieve superior impedance control and 12.5 Gbps data rates in high-bandwidth applications with GbX I-Trac™ Backplane Connector System — offered in traditional and orthogonal configurations for design flexibility

The GbX I-Trac™ Backplane Connector System features a broadside-coupled, skew-equalized design scalable to data rates up to 12.5+ Gbps. With its unique open pinfield design, the GbX I-Trac System gives customers the flexibility to assign high-speed differential pairs, lowspeed signals, power and ground contacts anywhere within the pin field.

The versatile design allows the headers to be rotated 90° on opposite sides of the midplane, creating an orthogonal architecture, eliminating the need for PCB traces by using shared vias through the midplane.

The same header and daughtercard part numbers are used for both standard and orthogonal configurations. The GbX I-Trac Backplane Connector System offers PCB designers flexibility to quad route the signal traces (two pairs per layer) reducing the PCB layer count. Integrated guidance options and stand-alone guidance options ensure superior mating performance and design. Power modules are capable of supporting over 250.0A of current per linear inch.

Components of the system include backplane signal header modules, daughtercard signal modules and rightangle male signal modules (coplanar), 7-, 11- and 15-row versions with press-fit module sizes ranging from 56 to 300 circuits.

Features and Benefits

Capable of supporting data rates of 12.5 Gbps	Enhanced NXT daughtercard enables scalable data rates up to 12.5 Gbps with backward compatibility to standard GbX I-Trac headers
Broadside-coupled, skew-equalized, differential pair system	Superior impedance control, low cross talk and improved insertion loss performance
Differential-pair density up to 69 pairs per linear inch using open-pin-field design	High-density, high-bandwidth connection with pin-by-assignment flexibility
Allows standard and orthogonal connections using the same parts	Design flexibility. Connector and PCB cost savings
Quad PCB routing capability	Reduces PCB layers required to route high-speed signals, reducing PCB cost
Integrated guidance	Superior mating performance
Bifurcated contact beams in daughtercard interface	Greater reliability with two points of contact to the header pin

GbX I-Trac™ Backplane Connector System

GbX I-Trac NXT Modules

- 76680** 11-Row NXT Daughtercards
- 171910** 15-Row NXT Daughtercards

GbX I-Trac Standard Modules

- 76015** 7-Row Backplane Headers
- 76020** 7-Row Daughtercard Signal Modules
- 76011** 7-Row Right-Angle Male Headers
- 75705** 11-Row Backplane Headers
- 75710** 11-Row Daughtercard Signal Modules
- 75910** 11-Row Right-Angle Male Headers
- 76035** 15-Row Backplane Signal Modules
- 76040** 15-Row Daughtercard Signal Modules

GbX I-Trac Power Modules

- 78227** 7-Row Vertical Receptacles
- 78229** 7-Row Right-Angle Headers
- 78230** 7-Row Right-Angle Receptacles
- 78232** 11-Row Vertical Receptacles
- 78234** 11-Row Right-Angle Headers
- 78235** 11-Row Right-Angle Receptacles
- 78237** 15-Row Vertical Receptacles
- 78684** 15-Row Right-Angle Headers

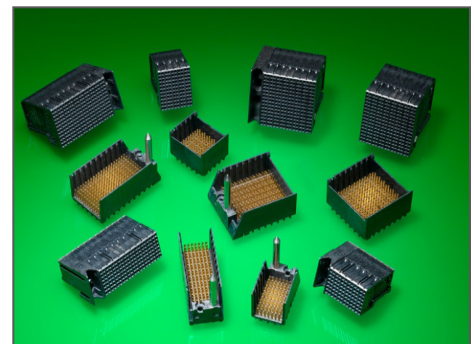

GbX I-Trac™ Backplane Connector System

Specifications

Reference Information

Packaging:
Daughtercard Assemblies — Trays
Headers:
7, 11 and 15 row — Trays
UL File No.: E29179
CSA File No.: Pending
Designed In: Millimeters

Electrical

Signal Contact Current Rating: 1.0A
Contact to Plated Through-Hole
Resistance (max.):
1.0 milliohm
Dielectric Withstanding Voltage:
750V RMS
Insulation Resistance (min.):
1,000 Megohms

Mechanical

Contact Insertion Force (max):
35.6N per contact
Contact Retention Force (min.):
4.45N per contact
Mating Force (max.):
0.69N per contact
Durability: 200 cycles

Physical

Housing:
Liquid Crystal Polymer, UL 94V-0
Contact:
High Performance Copper (Cu) Alloy
Plating:
Contact Area (min.) —
0.76µm Gold (Au)
Solder Tail Area —
Tin (Sn) or Tin/Lead (Sn/Pb)
Underplating — Nickel (Ni)
PCB Thickness (min.): 1.60mm
Operating Temperature: -55 to +85°C

Standard vs. NXT Comparison

GbX I-Trac Comparison Chart

Feature	Standard Daughtercard	NXT Daughtercard	Benefit of NXT version over Standard version
Mating Interface	Parallel	Staggered	Reduced insertion force
			Backwards compatible with standard GbX I-Trac headers
Compliant PCB Tails Length	2.10mm	1.30mm	Both compliant pin tails utilize 0.457mm PTH (0.559mm drill)
			PCB footprint compatible
			PCB footprint enables quad-routing
Lead Frame	Wider	Thinner	Enhanced signal integrity (SI) performance
Data Rates	6 Gbps	12.5 Gbps	Faster speed performance
Industry Protocol	PCIe	IEEE 802	Support Generation 2 and 3 Systems

Applications

Data Networking Equipment

- Servers
- Storage systems

Telecommunication Equipment

- Hubs, switches, routers
- Central office, cellular infrastructure and multi-platform service (DSL, cable data)

Medical Equipment

Military/Aerospace Equipment

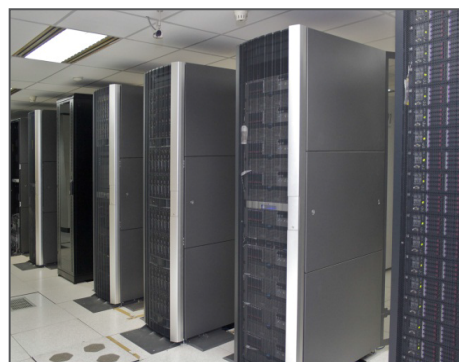

Datacenter



GbX I-Trac™ Backplane Connector System

Ordering Information

Click on hyperlinks to view all Order Numbers and product details within the Series Number



NXT Daughtercard Modules

Rows	Column Size	Differential Pairs	Pins	Order No.			Gold Thickness	Differential Impedance
				No Guide	Left Guide	Right Guide		
11	5	30	110	76680-1005	76680-3005	76680-5005	30μ" (0.76μm)	100 ohms
	6	36	132	76680-1006	76680-3006	76680-5006		
	8	48	176	76680-1008	76680-3008	76680-5008		
	10	60	220	76680-1010	76680-3010	76680-5010		
15	8	64	240	171910-10XX	171910-30XX	No Product Offering		
	9	72	270					
	10	80	300					



Standard Daughtercard Modules

Rows	Column Size	Differential Pairs	Pins	Order No.			Gold Thickness	Differential Impedance
				No Guide	Left Guide	Right Guide		
7	4	16	56	76020-1004	76020-3004	76020-5004	30μ" (0.76μm)	100 ohms
	6	24	84	76020-1006	76020-3006	76020-5006		
	10	40	140	76020-1010	76020-3010	76020-5010		
11	5	30	110	75710-1005	75710-3005	75710-5005	30μ" (0.76μm)	100 ohms
	6	36	132	75710-1006	75710-3006	75710-5006		
	8	48	176	75710-1008	75710-3008	75710-5008		
	10	60	220	75710-1010	75710-3010	75710-5010		
15	8	64	240	76040-1008	76040-3008	76040-5008		
	9	72	270	76040-1009	76040-3009	76040-5009		
	10	80	300	76040-1010	76040-3010	76040-5010		



**GbX I-Trac™
Backplane
Connector System**

Ordering Information

Click on hyperlinks to view all Order Numbers and product details within the Series Number

Standard Backplane Headers

Rows	Column Size	Differential Pairs	Pins	Mating Pin Length (mm)	Order No.			Gold Thickness	Differential Impedance
					No Guide	Left Guide	Right Guide		
7	4	16	56	3.90	76015-140X	76015-340X	76015-540X	30μ" (0.76μm)	100 ohms
				4.70					
				5.70					
				4.70 and 5.70 (staggered)					
	6	24	84	3.90	76015-160X	76015-360X	76015-560X		
				4.70					
				5.70					
				4.70 and 5.70 (staggered)					
	10	40	140	3.90	76015-110X	76015-310X	75705-510X		
				4.70					
				5.70					
				4.70 and 5.70 (staggered)					
11	5	30	110	3.90	75705-150X	75705-350X	75705-550X		
				4.70					
				5.70					
				4.70 and 5.70 (staggered)					
	6	36	132	3.90	75705-160X	75705-360X	75705-560X		
				4.70					
				5.70					
				4.70 and 5.70 (staggered)					
	8	48	176	3.90	75705-180X	75705-380X	75705-580X		
				4.70					
				5.70					
				4.70 and 5.70 (staggered)					
	10	60	220	3.90	75705-110X	75705-310X	75705-510X		
				4.70					
				5.70					
				4.70 and 5.70 (staggered)					

Ordering Information

Click on hyperlinks to view all Order Numbers and product details within the Series Number

Standard Backplane Headers

Rows	Column Size	Differential Pairs	Pins	Mating Pin Length (mm)	Order No.			Gold Thickness	Differential Impedance
					No Guide	Left Guide	Right Guide		
15	8	64	240	3.90	76035-180X	76035-380X	76035-580X	30μ" (0.76μm)	100 ohms
				4.70					
				5.70					
				4.70 and 5.70 (staggered)					
	9	72	270	3.90	76035-190X	76035-390X	76035-590X		
				4.70					
				5.70					
				4.70 and 5.70 (staggered)					
	10	80	300	3.90	76035-110X	76035-310X	76035-510X		
				4.70					
				5.70					
				4.70 and 5.70 (staggered)					

*Parts may be ordered upon request; contact Molex Inside Sales for information.

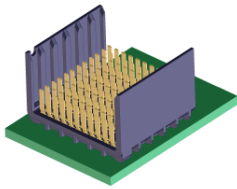

Open, (Unguided)

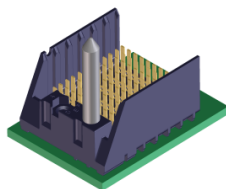

Left guide, right open

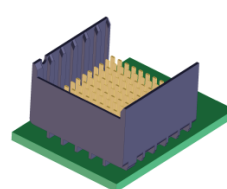

Left endwall, right open (unguided)

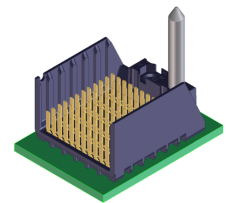

Left open, right guide

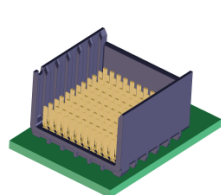

Right endwall, left open (unguided)

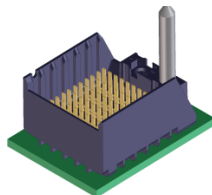

Left endwall, right guide

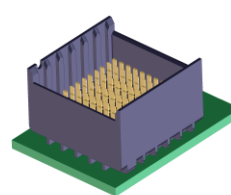

Dual endwall, unguided

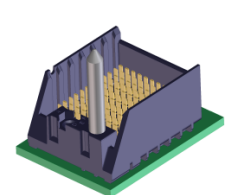

Left guide, right endwall

Ordering Information

Click on hyperlinks to view all Order Numbers and product details within the Series Number

Right-Angle Male (RAM) Headers

Rows	Column Size	Differential Pairs	Pins	Mating Pin Length (mm)	Order No.			Gold Thickness	Differential Impedance
					No Guide	Left Guide	Right Guide		
7	6	16	84	4.70	76011-160X	7611-362X	7611-562X	30μ" (0.76μm)	100 ohms
				3.80 & 4.70 (Staggered)					
10	24	24	140	4.70	76011-110X	7611-312X	7611-512X		
				3.80 & 4.70 (Staggered)					
11	5	30	110	4.70	75910-150X	75910-352X	75910-552X		
				3.80 & 4.70 (Staggered)					
	6	36	132	4.70	75910-160X	75910-362X	75910-562X		
				3.80 & 4.70 (Staggered)					
10	60	60	220	4.70	75910-110X	75910-312X	75910-512X		
				3.80 & 4.70 (Staggered)					

*Parts may be ordered upon request; contact Molex Inside Sales for information.



Right-Angle Male (RAM)
Header Unguided



Right-Angle Male (RAM)
Header with Guide

Ordering Information

Click on hyperlinks to view all Order Numbers and product details within the Series Number

Power Modules

Rows	Hold Down Location	Number of Power Modules	Blade Lengths (mm)	Power Module Right-Angle Header Order No.	Mating Connector Order No.		
					Right Angle Receptacle	Vertical Receptacle	
7	Left	1X	8.27, 8.27	78229-100X	78230-2101	78227-1001	
			8.27, 9.77				
			6.77, 9.77				
		2X	8.27, 8.27	78229-10XX	78230-2102		
			8.27, 9.77				
			6.77, 9.77				
	Right	1X	8.27, 8.27	78229-200X	78230-1101		
			8.27, 9.77				
			6.77, 9.77				
		2X	8.27, 8.27	78229-201X	78230-1102		
			8.27, 9.77				
			6.77, 9.77				
11	Left	1X	8.27, 8.27	78234-100X	78235-2101	78232-1001	
			8.27, 9.77				
			6.77, 9.77				
		2X	8.27, 8.27	78234-10XX	78235-2102		
			8.27, 9.77				
			6.77, 9.77				
	Right	1X	8.27, 8.27	78234-200X	78235-1101		
			8.27, 9.77				
			6.77, 9.77				
		2X	8.27, 8.27	78234-20XX	78235-1102		
			8.27, 9.77				
			6.77, 9.77				
15	Left	1X	6.77, 8.27, 9.77	78684-1005	No Product Offering	78237-1001	
		2X		78684-1055			
		Right		1X			78684-2005
				2X			78684-2055
	78684-8055						

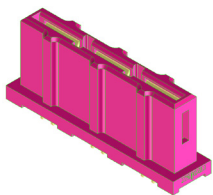

Vertical Receptacle

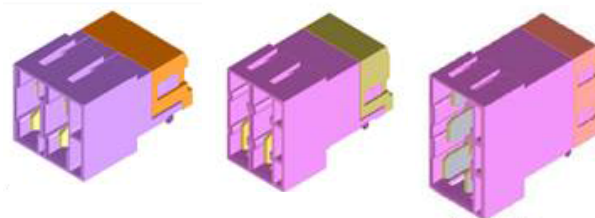

Right-Angle Header with Hold Down

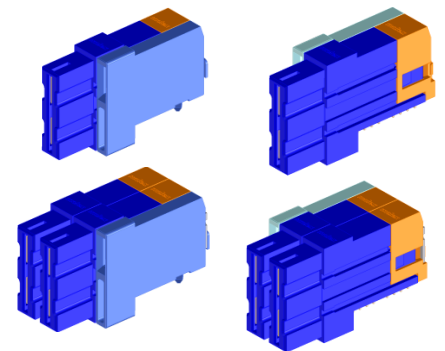

Right-Angle Receptacle with Hold Down

Ordering Information

Click on hyperlinks to view all Order Numbers and product details within the Series Number

GbX I-Trac™ Backplane Connector System

Backplane Signal Module Press-In Tooling

Header Type (Rows)	Number of Columns	Order No.
7	4	62201-8607
	6	62201-8608
	10	62201-8609
11	5	62201-8601
	6	62201-8602
	8	62201-8617
	10	62201-8603
15	8	62201-8619
	9	62201-8620
	10	62201-8621

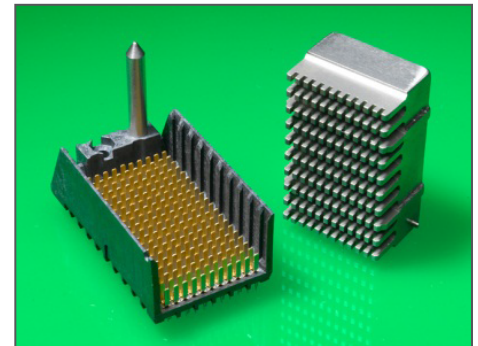

11-row, 10-column header press-in tooling

Daughtercard Signal Module Press-In Tooling

Header Type (Rows)	Number of Columns	Order No.
7	4	62201-8610
	6	62201-8611
	10	62201-8612
11	5	62201-8604
	6	62201-8605
	8	62201-8618
	10	62201-8606
15	8	62201-8622
	9	62201-8623
	10	62201-8624

Mechanical Hardware

Guide Modules	Receptacle	Freestanding Guide Pin
Without ESD Clip	76153-1001	75234-1478
With ESD Clip	76153-1002	

GbX is a registered trademark of Amphenol TCS

www.molex.com/product/itrac.html