

MICRO SWITCH
 FREEPORT, ILLINOIS, U.S.A.
 A DIVISION OF HONEYWELL
 FED. MFG. CODE 91929

**ASSEMBLY -
 TOGGLE SWITCH**

CATALOG LISTING
68AT22 SERIES
CHART 2

CATALOG LISTING	KEYWAY POSITION		CENTER POSITION		OPPOSITE KEYWAY POSITION		RECOMMENDED LOCKING COMBINATIONS
	C-NO	C-NC	C-NO	C-NC	C-NO	C-NC	
68AT22-1	5,6,7,8	1,2,3,4	NONE	ALL	1,2,3,4	5,6,7,8	A,B,D,E,F,G,H,J,K,L,M,N,P
68AT22-3	5,6,7,8	1,2,3,4	NONE	NONE	1,2,3,4	5,6,7,8	D,F,G
68AT22-5	5,6,7,8*	1,2,3,4*	NONE	ALL	1,2,3,4	5,6,7,8	E,F,K,L,M,N
68AT22-7	5,6,7,8*	1,2,3,4*	NONE	ALL	1,2,3,4*	5,6,7,8*	E,L,N

* ASTERISK DENOTES MOMENTARY POSITION

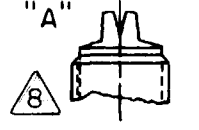
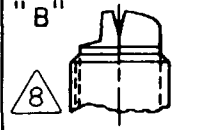
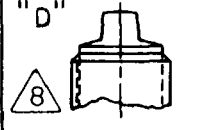
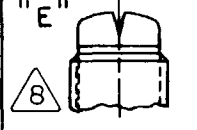
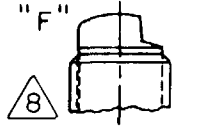
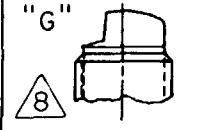
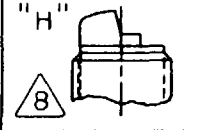
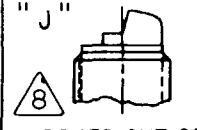
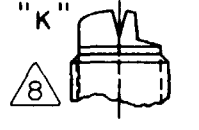
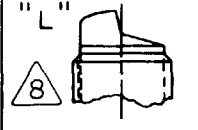
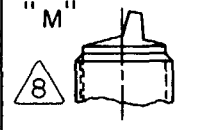
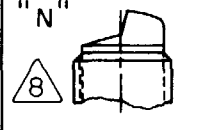
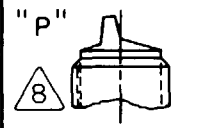
"A"  LOCKED IN THREE POSITIONS	"B"  LOCKED IN CENTER AND EXTREME POSITION (KEYWAY SIDE)	"D"  LOCKED OUT OF CENTER POSITION	"E"  LOCKED IN CENTER POSITION
"F"  LOCKED IN EXTREME POSITION (OPPOSITE KEYWAY)	"G"  LOCKED IN EXTREME POSITION (KEYWAY SIDE)	"H"  LOCKED OUT OF CENTER AND EXTREME POSITION (KEYWAY SIDE)	"J"  LOCKED OUT OF CENTER AND EXTREME POSITION (OPPOSITE KEYWAY)
"K"  LOCKED IN CENTER AND EXTREME POSITION (OPPOSITE KEYWAY)	"L"  LOCKED OUT OF EXTREME POSITION (KEYWAY SIDE)	"M"  LOCKED OUT OF AND INTO EXTREME POSITION (OPPOSITE KEYWAY)	"N"  LOCKED OUT OF EXTREME POSITION (OPPOSITE KEYWAY)
			"P"  LOCKED OUT OF AND INTO EXTREME POSITION (KEYWAY SIDE)

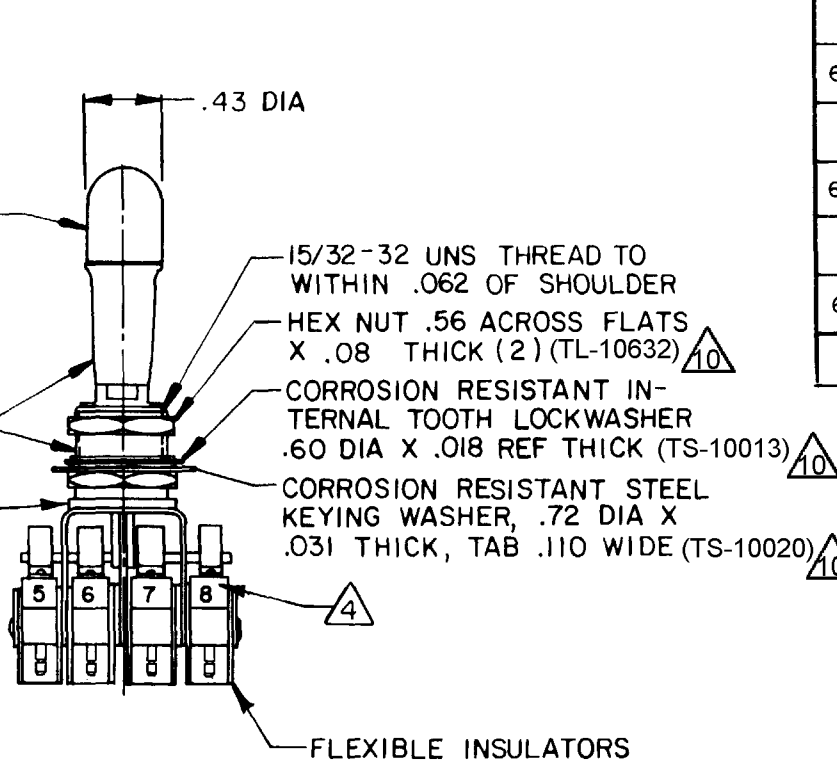
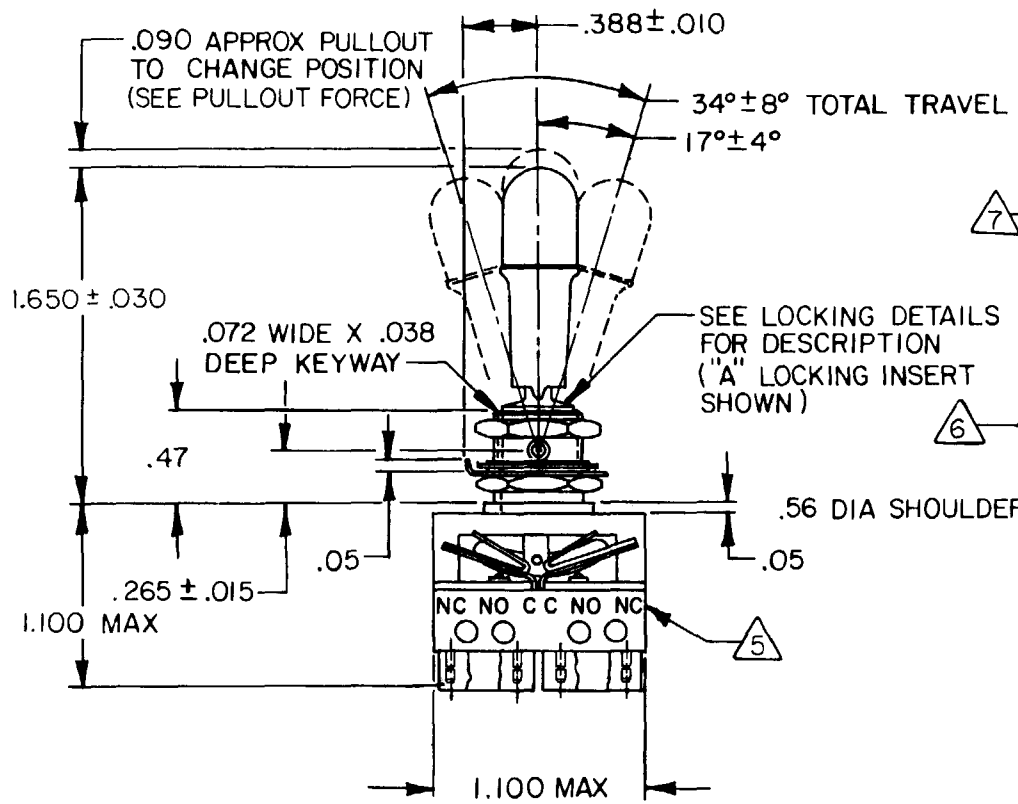

- NOTES**
- UNIT INCLUDES "SX" TYPE BASIC SWITCH (8) (MEETS REQUIREMENTS OF MIL-PRF-8805/4)
 - SWITCHES DO NOT NECESSARILY OPERATE SIMULTANEOUSLY
 - PLATED TERMINALS WILL ACCEPT "AMP INC." .058 DIA PIN RECEPTACLES
 - SWITCH NUMBERS MARKED ON END OF BASIC SWITCHES
 - TERMINAL DESIGNATION STAMPED ON BOTH SIDES OF UNIT
 - DULL FINISH ON LEVER AND BUSHING
 - FLAT WHITE RESILIENT SILICONE (50 DUROMETER APPROX)
 - SUFFIX LETTER MUST BE ADDED FOR DESIRED TYPE TOGGLE LOCKING (SEE CHART FOR RECOMMENDED LOCKING COMBINATIONS)
 - FOR REPLACEMENT BUTTON SEE MICRO SWITCH CATALOG LISTING 15PA90-6W
 - HARDWARE FURNISHED ASSEMBLED WITH SWITCH OR IN PACKET 15PA313-AT PER MIL-PRF-8805
 - REPLACEMENT MOUNTING HARDWARE PACKET 15PA313-AT
 - SWITCH MEETS THE REQUIREMENTS OF MIL-PRF-8805/98 EXCEPT INITIAL CONTACT RESISTANCE IS 50 MILLIOHMS MAX AND FINAL CONTACT RESISTANCE AFTER MECHANICAL ENDURANCE IS 600 MILLIOHMS MAX.

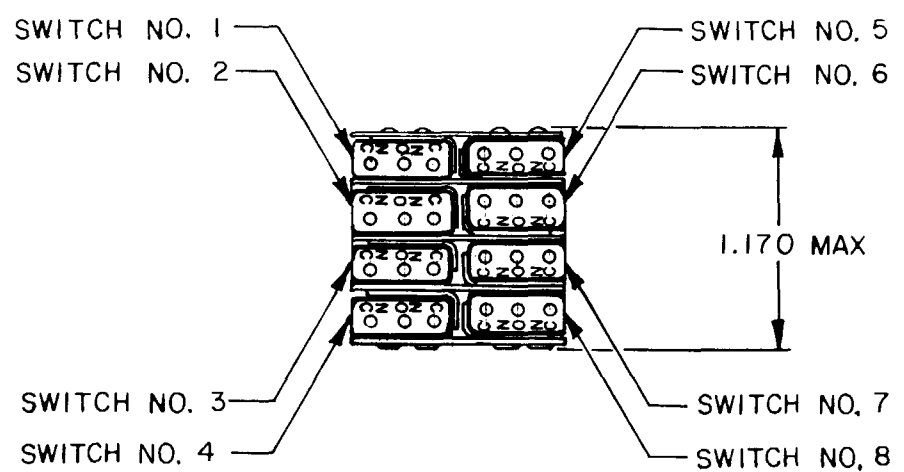

CATALOG LISTING 68AT22 SERIES CHART 2
 PAGE 1 OF 1
 RELEASE NO. PR-11029
 11 FEB 04
 MDM
 CHECK
 REVISIONS
 A CO-515968 KAG 12 OCT 83
 B CO72702 L J F 9 JUN 92
 C CO81168 JALA 12 OCT 95
 D CO95233 CO 95233 J J A 6 JULY 99
 E 203961 CSL 20 SEP 01
 F 204763 G J W 28 JAN 02
 G 0003376 AS 11 FEB 04
 DRAWN T S K 15 MARCH 82
 RASTER

THIS DRAWING COVERS A PROPRIETARY ITEM AND IS THE PROPERTY OF MICRO SWITCH, A DIVISION OF HONEYWELL. THIS DRAWING IS NOT TO BE COPIED OR USED WITHOUT THE APPROVAL OF MICRO SWITCH.

CHARACTERISTICS	ELECTRICAL DATA
PULLOUT FORCE----- 3 LB MIN-5 LB MAX	CONTACT ARRANGEMENT S P D T (8)

SCALE FULL
 DO NOT SCALE PRINT

TOLERANCES
 APPLY TO DESIGN UNITS. CONVERSIONS ARE ONLY FOR REFERENCE. UNLESS NOTED, TOLERANCES ARE ±

DIM.	TOL.	DIM.	TOL.
mm	mm/in	in	mm/in
NO PLACES	X	1/64	X X
ONE PLACE	X.X	0.01/0.08	X.XX
TWO PLACES	X.XX	0.15/0.008	X.XXX
THREE PLACES	X.XXX		X.XXXX
ANGLES			

DESIGN UNITS SI METRIC US CUSTOMARY

THIRD ANGLE PROJECTION

WEIGHT .11 LB APPROX

ELECTRICAL RATINGS

LOAD	SEA LEVEL		50,000 FT
	28 Vdc (AMPERES)	115 Vac, 60 Hz (AMPERES)	28 Vdc (AMPERES)
RESISTIVE	7	7	4
INDUCTIVE	4	7	2.5