

- High-Q MLC Capacitors
- Low ESR MLC Capacitors
- Single Layer Capacitors
- Broadband Blocking Capacitors
- Thin Film Ceramic Filters
- High-K Ceramic Substrates and Plates
- Thin Film Resonators
- Thin Film Gain Equalizers
- Custom Ceramic Components

# *MLC & SLC Capacitors Thin Film Components*

# Introduction to Dielectric Laboratories Inc.

## What makes DLI Unique?

DLI built its global reputation as a manufacturer of high frequency, High Q capacitors. In recent years, DLI has emerged as a comprehensive manufacturer of specialty ceramic components for application specific microwave and millimeter wave components serving customers in fiber optic, wireless, medical, transportation, semiconductor, space, avionics and military markets.

With over four decades of material science formulation and development, more than one hundred proprietary and/or patented ceramic formulations, and multiple recent patent filings, DLI is the pre-eminent ceramic component manufacturer in the industry. The marriage of ceramic expertise, manufacturing know-how, product quality, customer service, product customization, and clever microwave and RF design engineering sets us apart from all others in the industry.

DLI offers a broad range of Multi-Layer Capacitor products. We have the most comprehensive array of Broadband Blocking capacitors. We have expertise in customizing, tight tolerances and meeting specific design targets.

DLI is the preeminent global supplier of Single-Layer Capacitors. We have the world's broadest range of materials starting with Class 1 dielectrics with  $\epsilon_r$  from 5.7 to 900 and Class 2 dielectrics with  $\epsilon_r$  from 445 to 25,000. DLI specializes in high reliability and space applications.

Our Build-to-Print services designed to facilitate thin film product design, manufacturing and testing from prototype to high volume production. Our custom ceramics offer significantly better thermal performance than majority of industry standard ceramics and have an added benefit of a sufficiently higher dielectric constant (K) allowing miniaturization opportunities and temperature stable performance.

DLI continues to introduce exciting new innovations in custom ceramic resonator and filter technologies. These patent-protected products leverage decades of ceramic and Thin Film experience, creative and clever design expertise, and advanced prototyping and testing capabilities. Please discuss your needs with our Sales and Applications Engineering Team.

Heat Sinks and Resonator Components complete our portfolio.

## RoHS Compliance Statement

DLI is a leading supplier to the electronic components market and is fully committed to offering products supporting Restriction of Hazardous Substances (RoHS) directive 2011/65/Eu. All of our Dielectric formulations are RoHS compliant and we offer a broad range of capacitors with RoHS compliant terminations. DLI complies with the requirements of the individual customer and will maintain product offerings that meet the demands of our industry.

## Quality and Environmental Policy

DLI's reputation for quality and environmental responsibility is based on a commitment not only to meet our customers' requirements, but to exceed their expectations. The entire organization, beginning with top management, strives to achieve excellence in designing, manufacturing and delivering High Q capacitors and proprietary thin film components for niche high frequency applications, while maintaining safe and healthy working conditions. Furthermore, DLI commits to achieve these goals in an environmentally responsible manner through our commitment to comply with environmental regulations and implement pollution prevention initiatives. DLI strives to continually improve the effectiveness of our Quality and Environmental Management System through the establishment and monitoring of objectives and targets.



[www.dilabs.com](http://www.dilabs.com)

# Contents

---

## Introduction

About Us .....	Inside front cover
What's New at DLI .....	2
Simplified Frequency & Application Chart .....	3

## Single Layer Capacitors

General Information .....	4-6
Packaging .....	7
Border Cap <sup>®</sup> 1 or 2-sided recessed metallization .....	8-11
T-Cap <sup>®</sup> Transmission Line Capacitor .....	12
Di-Cap <sup>®</sup> 1MHz to > 80GHz .....	13-15
Bar Cap <sup>®</sup> Multiple arrays .....	16
Gap Cap <sup>®</sup> to eliminate wire bonding .....	17-19
Bi-Cap <sup>®</sup> Binary Capacitor .....	20
Heatsinks, Standoffs & Submounts .....	21

## Multilayer Ceramic Capacitors

Material & Case Size Summary Sheets .....	22-23
Application Notes .....	24-25
General Information .....	26-27
Standard Part Number System .....	28
AH Series: P90 Porcelain Capacitors .....	29-31
CF Series: Ultrastable Porcelain Capacitors .....	32-34
NA Series: N30 Porcelain Capacitors .....	35
UL Series: Ultra Low ESR Ceramic Capacitors .....	36-38
High Q Capacitors - C04, C06, C11 & C17 Kits .....	39

## Broadband Blocking Capacitors

C04/C06/C08 Broadband Blocking Capacitor .....	40
Opti-Cap <sup>®</sup> Ultra Broadband DC Blocking .....	41-43
Milli-Cap <sup>®</sup> Millimeter Wave Broadband Blocking Capacitor .....	44
Miniature RF Blocking Network .....	45-46

## Thin Film Devices

RF Guru Ceramic Filter Request Form .....	47
Ceramic Filters product summary .....	48-49
Filter Packaging, Shielding and Mounting .....	50-51
Filter Temperature Stability .....	52
Surface Mount Lowpass Filter Series .....	53
2-18 GHz Bandpass Filter Series .....	54
Wilkinson Power Divider .....	55
Symmetric Dual Mode Resonator Filter .....	56
10GHz 4 Pole Band Pass with Bandstop Filter .....	56
20GHz 8 Pole SMT Filter .....	56
36GHz Filter Repeatability .....	56
GPS Filters .....	57
High-K Ceramic Substrate and Plates .....	58
Ceramic Cavity Resonators .....	59-65
Self Bias Network .....	63-64
Gain Equalizers .....	65-67
Build to Print .....	68

---

# What's New at DLI

## 0402

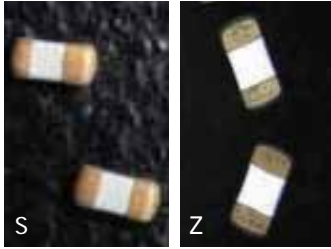

0402 product line extension of Z type plating (Sn over Ni) in the C04 (0402) case size with its Ultra-Low ESR UL dielectric material. Previously the C04 product line was only available in "S" type plating (Au flash over Ni).

Plating Code	Layers	Applications
"S"	<ul style="list-style-type: none"> <li>Au Flash (3-5<math>\mu</math>" )</li> <li>Ni barrier Layer</li> <li>Ag Termination</li> </ul>	<ul style="list-style-type: none"> <li>Specialty Solder &amp; Epoxy</li> </ul>
"Z"	<ul style="list-style-type: none"> <li>Sn plated solder</li> <li>Ni barrier layer</li> <li>Ag Termination</li> </ul>	<ul style="list-style-type: none"> <li>High Volume &amp; Hand Solder</li> </ul>

Both termination types are fully RoHS compliant Dielectric Laboratories Inc. C04 case size meets the EIA 0402 footprint, which is perfectly suited for High Frequency decoupling type of applications.

## Milli-Caps®

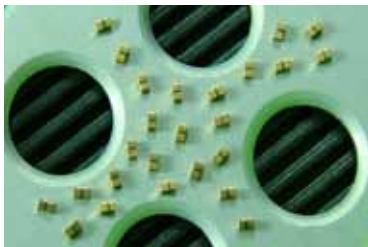

Available in 0402, 0502 and 0602 footprints with capacitance values ranging from 0.3pF to 82pF. These capacitors are perfect for testing equipment, photonics, SONET, digital radios and matching filter

applications. A usable frequency range up to 40GHz with very low series inductance and ultra-high series resonance makes this the ideal capacitor for your broadband blocking needs.

## 50V UX material

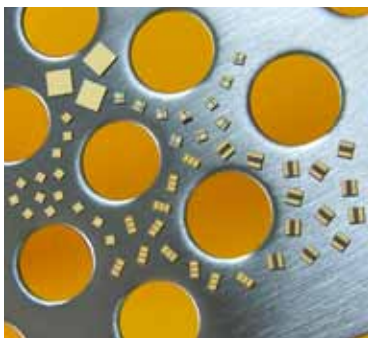

The UX material space qualified to MIL-PRF-38534 Class K is now available in a 50V rating. DLI's broad range of standard architectures, including Di-Caps®, Border Caps®, Bar Caps® and Gap Caps® can utilize the new 50V rated high K dielectric. UX has

the highest dielectric constant of any of DLI's wide variety of materials. The high dielectric constant (K) allows for higher capacitance values in smaller case sizes. This means smaller components on your boards without sacrificing performance!

- Ultra-High Dielectric Constant K=25,000
- X7R Temperature Stability
- Highest Capacity Density SLC
- Ideal for Epoxy & Wire Bond Assembly
- Voltage Rating of 25V & 50V
- Rugged Ceramic & Thin Film Gold
- Excellent Dimensional Tolerance

## Catalog Filters



Newly released Catalog Lowpass and Bandpass Filters for high frequency applications. This small, surface mount filters have temperature stable performance from 2 GHz up to 50 GHz. The filters integrate DLI's

high dielectric, temperature stable ceramic materials to offer high reliability in environmentally challenging conditions. Continue to check our website for new additions.

## Cavity Filters

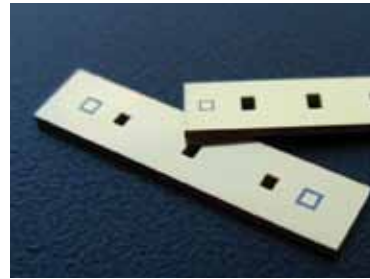

Ceramic cavity resonator technology can be employed in conjunction with DLI's stable, high Q ceramics to create highly selective, small, low loss band pass filters. Using a multi-port implementation, a very small robust filter

can be created. Wide reject band performance without spurious modes is possible. The small, shielded nature of the ceramic filter implementation makes it an ideal choice for integration in low noise receiver front ends with the antenna and pre-amplifier.

High-order band pass filters are created by cascading single cavity resonators to generate the required rejection.

## Build to print

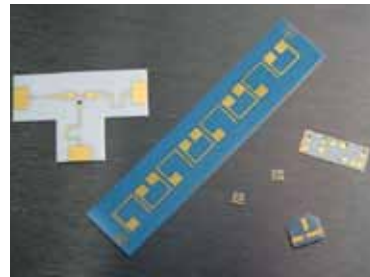

DLI offers Build to Print services designed to facilitate thin film product design, manufacturing and testing from prototype to high volume production. Our custom ceramics offer significantly

better thermal performance than the majority of the industry standard ceramics and have an added benefit of a sufficiently higher dielectric constant (K) allowing miniaturization opportunities and temperature stable performance.

## Gain Equalizers



Gain Equalizers are designed as a small, low cost solution to your gain slope challenges. DLI's EW series is designed to address the issue from DC to 18 GHz in a package smaller than an 0302 capacitor. Components are designed for surface mount pick and place equipment or epoxy mount.

# Simplified Frequency & Product Application Chart

## SLC and Thin Film

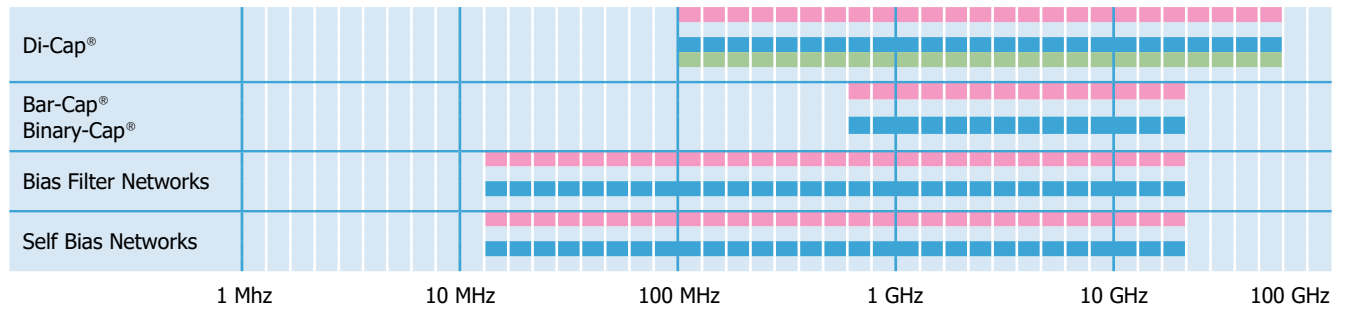

## High Q Capacitors

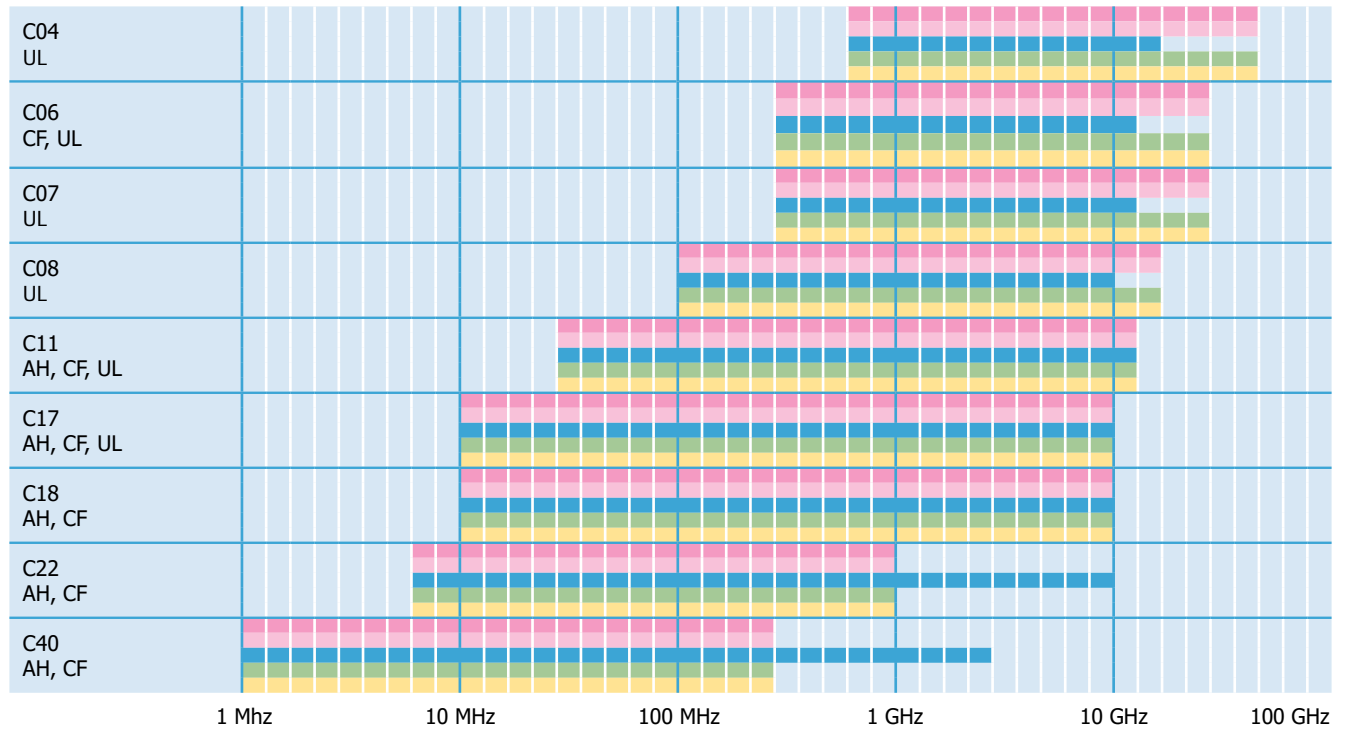

## Broadband and DC Blocks

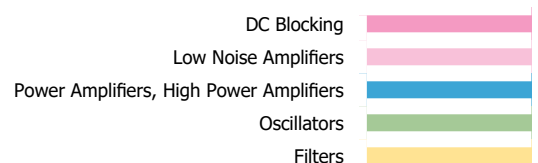
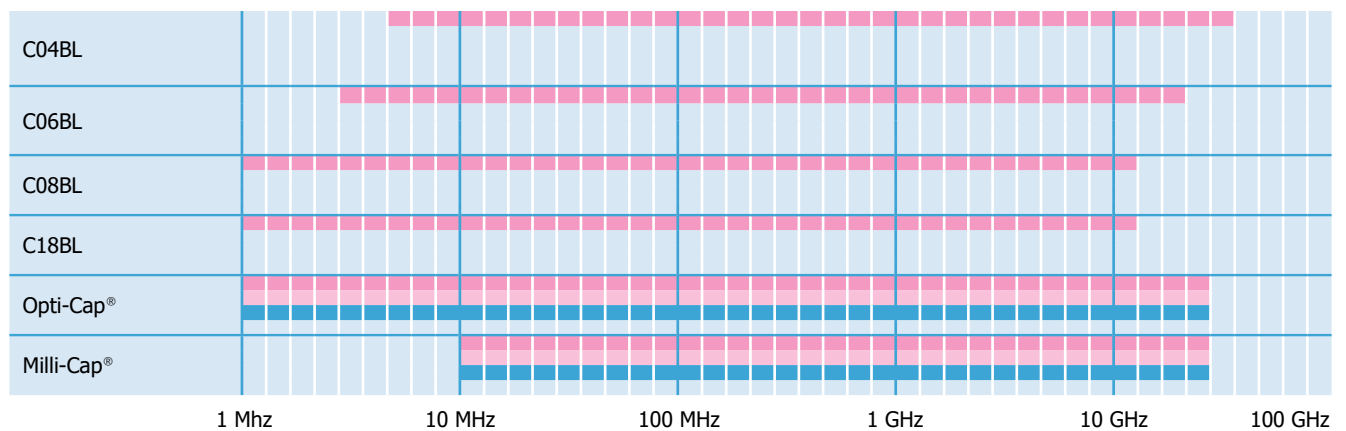

# SLC - Dielectric Information

Single Layer Capacitors are available with any of our proprietary dielectric materials in the following configurations:

- Border Cap<sup>®</sup>
- Di-Cap<sup>®</sup>
- Bar Cap<sup>®</sup>
- Bi-Cap<sup>®</sup>
- Gap Cap<sup>®</sup>
- T-Cap<sup>®</sup>

Please consult the following pages for part number identification.



## DLI Class I Dielectric Materials

Dielectric Code	Relative $\epsilon_r$ @ 1 MHz	Temperature Coefficient -55°C to 125°C (ppm/°C Max)	1 MHz Dissipation Factor (% Maximum)	25°C Insulation Resistance (M $\Omega$ )	125°C Insulation Resistance (M $\Omega$ )
PI	9.9	P105 $\pm$ 20	0.15	>106	>105
PG	13	P22 $\pm$ 30	0.15	>106	>105
AH	20	P90 $\pm$ 20	0.15	>106	>105
CF	24	0 $\pm$ 15	0.60	>106	>105
NA	22	N30 $\pm$ 15	0.15	>106	>105
CD	37	N20 $\pm$ 15	0.15	>106	>105
NG	43	N220 $\pm$ 60	0.25	>106	>105
CG	70	0 $\pm$ 30	0.70	>106	>105
DB	72	N50 $\pm$ 30	0.15	>106	>105
NP	85	N750 $\pm$ 200	0.50	>104	>103
NR	160	N1500 $\pm$ 500	0.25	>106	>105
NS	300	N2400 $\pm$ 500	0.70	>106	>105
NU	600	N3700 $\pm$ 1000	1.50	>106	>105
NV	900	N4700 $\pm$ 1000	1.20	>106	>105

## DLI Class II Dielectric Materials

Dielectric Code	Relative $\epsilon_r$ @ 1 MHz	Temperature Coefficient -55°C to 125°C (ppm/°C Max)		1 MHz Dissipation Factor (% Maximum)	25°C Insulation Resistance (M $\Omega$ )	125°C Insulation Resistance (M $\Omega$ )
		No Bias, Pre Voltage Conditioning	No Bias, Post Voltage Conditioning			
BF*	445	$\pm$ 7.5	$\pm$ 10	2.5	>104	>102
BD	700	$\pm$ 10	$\pm$ 15	2.5	>104	>103
BG*	900	$\pm$ 10	$\pm$ 15	2.5	>104	>103
BC	1300	$\pm$ 10	$\pm$ 15	2.5	>104	>103
BE	1250	$\pm$ 10	$\pm$ 15	2.5	>104	>103
BL	2000	$\pm$ 15	$\pm$ 25	2.5	>105	>104
BJ	3300	$\pm$ 10	$\pm$ 15	3.0	>105	>104
BN	4500	$\pm$ 15	$\pm$ 25	3.0	>105	>104

## DLI Class III Dielectric Materials

BT*	4200	+22, -56% (-55°C to 105°C)	+22, -56% (-55°C to 105°C)	3.0	>105	>102
BU	8500	+22, -82% (10°C to 85°C)	+22, -82% (10°C to 85°C)	3.0	>105	>104
BV	13,500	+22, -82% (10°C to 85°C)	+22, -82% (10°C to 85°C)	3.0	>105	>104
UX	25,000	$\pm$ 15%	$\pm$ 25%	2.5	>103	>102

\* Recommended for commercial use only. Please contact an inside sales representative for additional information.

# SLC - Dielectric Information

## Dielectric Temperature Characteristics

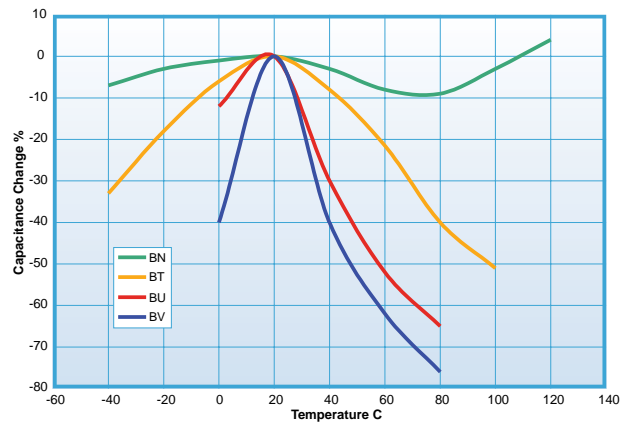
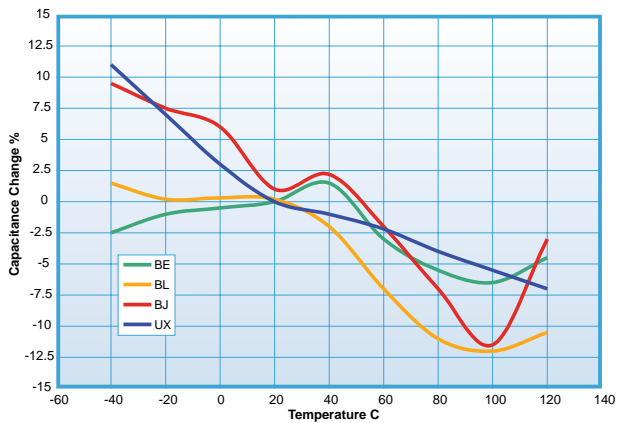
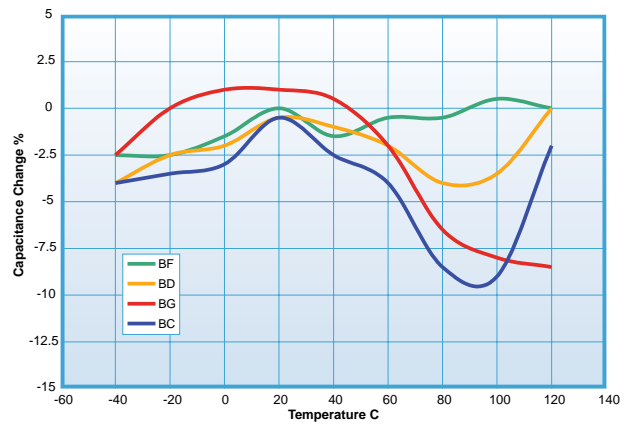
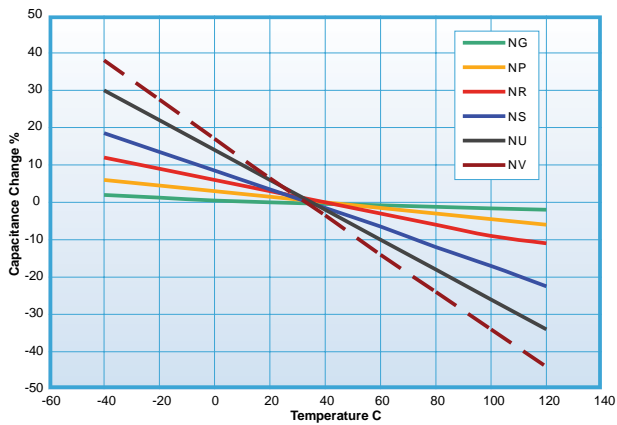
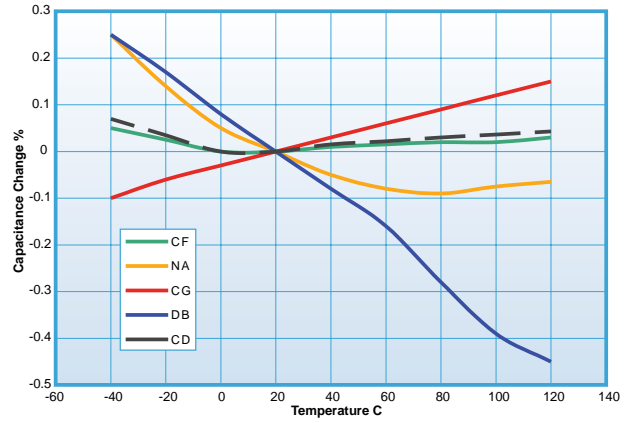
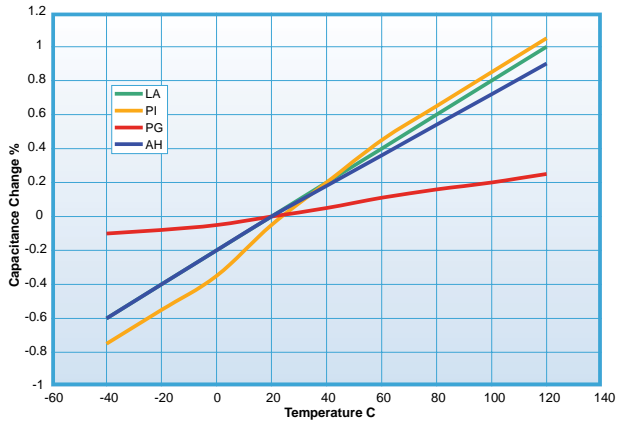



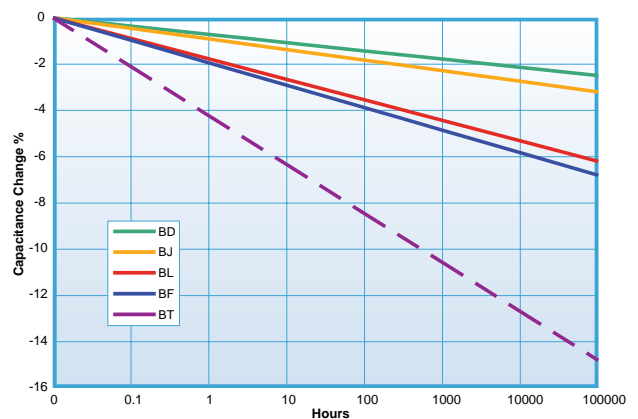
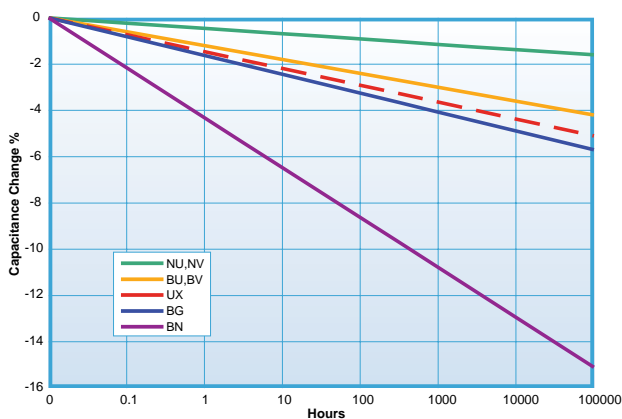







## Dielectric Aging Characteristics

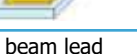
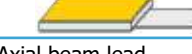

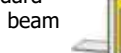
# SLC - Specifications

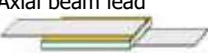
## Termination Codes

	Code	Description (Layers in order from dielectric material to outermost)		Capacitor Types
	P	S1 (Sputter Plated)		Di-Cap®, T-Cap®, Bar Cap®, Binary Cap®, and Gap Cap
		1. 300 Angstroms Titanium-Tungsten 2. 50µ Inches min. Nickel-Vanadium 3. 100µ Inches min. Gold		
		AU-100 (Wet Plated)		
	T	S2		Di-Cap®, T-Cap®
		1. 300 Angstroms Titanium-Tungsten 2. 50µ Inches min. Nickel-Vanadium 3. 300µ Inches min. Gold-Tin		
	M	S5		Di-Cap®, T-Cap®, Bar Cap®, Binary Cap®, and Gap Cap
		1. 300 Angstroms Titanium-Tungsten 2. 100µ Inches min. Gold		
	B	S1	AU-100	Single Border Cap
	E	S1	AU-100	Double Border Cap
Single beam lead 	L	Standard lead material is silver (Ag) .002" thick. Optional Gold (Au)		Di-Cap®
Axial beam lead 		Standard lead material is Silver (Ag) .002" thick. Optional Gold (Au)		
Standard axial beam lead 	Z	Standard lead material is Tin-Copper (Sn,Cu) .002" thick. Optional Gold (Au)		Di-Cap®
	S	Standard lead material is silver (Ag) .002" thick. Optional Gold (Au)		Di-Cap®



## Test Level Codes

Code	Description
<b>Industrial / Commercial Options</b>	
Y	<ul style="list-style-type: none"> <li>1% AQL 2 Side Visual Screening</li> </ul>
X	<ul style="list-style-type: none"> <li>100% 4 Side Visual Screening</li> <li>1% AQL for the electrical parameters Capacitance, Dissipation Factor, Insulation Resistance, and Dielectric Withstanding Voltage</li> </ul>

<b>High Reliability Options</b>	
A	MIL-PRF-49464 Group A <ul style="list-style-type: none"> <li>100% Thermal Shock</li> <li>100%, 100 +0/-4 Hours Voltage Conditioning</li> <li>100% Electrical Screening</li> <li>100% 6 Side Visual Screening</li> <li>Bond Strength</li> <li>Die Shear Strength</li> <li>Temperature Coefficient Limits</li> </ul>
B	MIL-PRF-49464 Group B <ul style="list-style-type: none"> <li>MIL-PRF-49464, Group A</li> <li>Immersion</li> <li>Low Voltage Humidity</li> <li>Life</li> </ul>
D	Special agreed upon testing to customers' formal specification. Customer Drawing Required! (May include, but is not limited to, one or more of the following common requests.) <ul style="list-style-type: none"> <li>MIL-PRF-38534 Class H Element Evaluation.</li> <li>MIL-PRF-38534 Class K Element Evaluation.</li> <li>10(0) Destructive Bond Pull per MIL-STD-883, Method 2011.</li> <li>10(0) Die Shear per MIL-STD-883, Method 2019.</li> </ul> Consult Factory for other alternatives or assistance in specifying custom testing.
E	6 Side Visual Screening per MIL-STD-883, Method 2032.

All Single Layer Capacitors are Lead Free and RoHS compliant.

## Capacitance Tolerance Table

Tolerance Code	Tolerance
A	±.05pF
B	±.10pF
C	±.25pF
D	±.50pF
E	±.5%
F	±1%
G	±2%
H	±3%
I	±4%
J	±5%
K	±10%
L	±15%
M	±20%
X	GMV
V	+100%, -0%
Z	+80% , -20%
S	Special

## Environmental & Physical Testing Procedures

Parameter	Method	MIL-STD-202
		Condition
Thermal Shock	107	A, (modified), -55°C to +125°C.
Immersion	104	B
Moisture Resistance	106	-
Resistance to Solder Heat	210	C, 260°C for 20 seconds.
Life	108	A, 96 Hours @ +125°C.
Barometric Pressure	105	B
Shock, (Specified Pulse)	213	I, 100g's, 6ms.
Vibration, High Frequency	204	G, 30g's peak, 10Hz to 2kHz.

Parameter	Method	MIL-STD-883
		Condition
Bond Strength	2011	D, 3 grams minimum with .001" dia wire
Die Shear Strength	2019	Limit per MIL-STD-883, Figure 2019-4.
Temperature Cycling	1010	C
Mechanical Shock	2002	B,Y1,
Constant Acceleration	2001	3,000g's, Y1 direction



# SLC - Packaging

## SLC Waffle Packaging

DLI offers a wide variety of standard design waffle packs in various materials depending on the application. Typical material offerings are antistatic and gel pack, which can contain up to 400 pieces depending on component dimension. Custom waffle packs are available; please consult the factory for details.

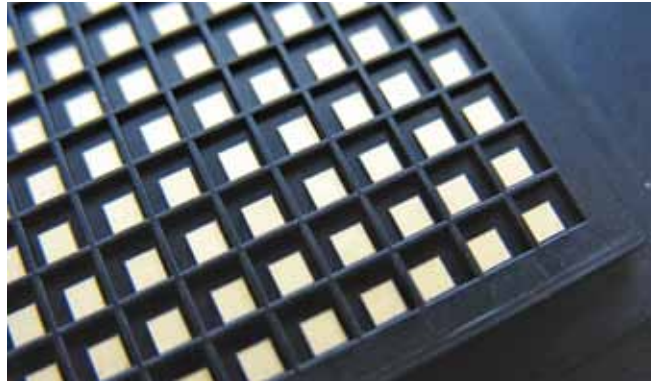

SLC Waffle Packaging

## SLC Tape and Reel

DLI offers tape and reel packaging solutions for a variety of our single layer capacitor case sizes. Utilizing the latest technology and equipment to provide our customers the highest quality products, our standard SMD tape and reel packaging meets or exceeds EIA standards. Custom tape and reel packaging available; consult the factory for options.



SLC Tape and Reel

## SLC on Tape Ring

DLI offers single layer capacitors re-populated on blue membrane tape and photon ring assembly to maximize efficiency and minimize product cost. Used in high volume applications, the re-populated capacitors provide for more efficient component placement and fewer "pick and place" machine change outs. The re-populated capacitors meet GMV capacitance value, are 100% visually acceptable and can be re-populated in custom shapes and sizes on a 6 inch photon tape ring.

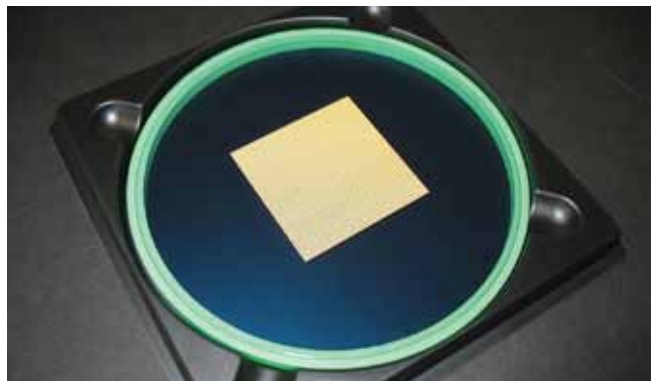

SLC on Tape Ring

## SLC "Black Dotted" on Tape Ring

DLI offers "black dotted" capacitors on membrane tape and photon ring assembly. For high volume applications utilizing visual recognition, a less expensive alternative is the use of "black dotted" capacitors provided on saw dice membrane tape. The non- "black dotted" capacitors meet GMV capacitance value and a minimum of 75% visually acceptable product is guaranteed.

## Storage

Single layer capacitors with applicable terminations will be solderable for a minimum of 1 year from date of shipment if properly stored in their original packaging. For extended periods, storage in a dry nitrogen environment is recommended. Product supplied on membrane tape and photon ring should be stored in the original container and in an environmentally controlled area where temperature and humidity are maintained. It is recommended not to store the product in direct light as this can negatively impact the adhesion properties of the tape.

## Handling

Single layer ceramic capacitors should be handled carefully during component transfer or placement, preventing damage to the gold and ceramic surfaces. The capacitors should be handled with precision stainless steel tweezers or a vacuum wand. Contacting the capacitor with bare hands should be avoided as resulting contaminants will affect the performance of the component.



SLC "Black Dotted" on Tape Ring

# SLC - Border Cap®

## Description

SLC with recessed metallization available with border on one or both sides.

- Recessed metallization minimizes the potential for shorting during die attach
- Bordered area provides contrast for vision recognition during automated placement and wire bonding
- Thin film technology
- ESD proof

## Functional Applications

- DC Blocking
- RF Bypass
- Filtering
- Tuning and Submounts

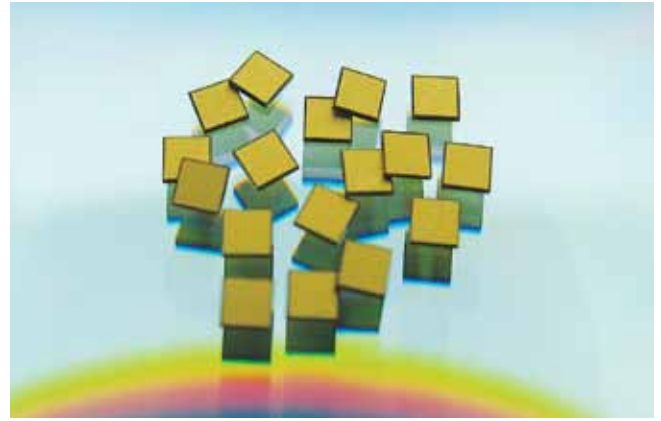

## Double Border Cap® Designer Kits 160 Capacitors, 10 Each of 16 Values

Part Number	Capacitor Width	10 Capacitors of each value								
		Dielectric	pF	Tol.	pF	Tol.	pF	Tol.	pF	Tol.
D10XXKITA1EX	.010"	Class I, see codes on Page 4	0.1	B	0.6	C	1.5	C	2.7	D
			0.4	B	1.0	C	2.2	D	3.3	D
		Class II, see codes on Page 4	3.9	D	5.6	M	8.2	M	20	M
			4.7	D	6.2	M	10	M	33	M
D15XXKITA1EX D20XXKITA1EX	.015"	Class I, see codes on Page 4	0.1	B	0.7	C	1.5	C	3.3	D
			0.4	B	1.0	C	2.2	C	6.4	D
	.020"	Class II, see codes on Page 4	6.8	K	10	K	20	M	50	M
			8.2	K	15	K	33	M	100	M
D25XXKITA1EX D30XXKITA1EX	.025"	Class I, see codes on Page 4	0.4	B	1.7	C	4	D	8.2	K
			0.6	C	1.9	C	5	D	10	K
			0.9	C	2.7	C	5.6	D	20	K
	.030"	Class II, see codes on Page 4	33	M	50	M	100	M	180	M

DLI reserves the right to substitute values as required.

Customer may request particular cap value and material for sample kit to prove out designs.

## Part Number Identification

D	10	BN	100	K	1	E	X	
<b>Product</b> D = Border Cap®	<b>Case Size</b> 10 12 15 20 25 30 35 40 50	<b>Material</b> See material tables on Page 4.	<b>Capacitance (pF)</b> R02 = 0.02 pF 0R5 = 0.5 pF 1R0 = 1.0 pF 5R1 = 5.1 pF 100 = 10 pF 101 = 100 pF 152 = 1500 pF  Refer to Capacitance range tables for available values. Consult an inside sales rep. for custom solutions.	<b>Tolerance</b> A = ± 0.05pF B = ± 0.10pF C = ± 0.25pF D = ± 0.5pF F = ± 1% G = ± 2% J = ± 5% K = ± 10% L = ± 15% M = ± 20% Z = +80% -20%	<b>Voltage</b> 2 = 25V* 1 = 100V  *For Capacitors with UX material only	<b>Termination</b> P = Ni / Au B = Single Border E = Double Border M = Au	<b>Test Level</b> Y, X, A, B, D and E.  See test level definitions on Page 6.	<b>Packaging</b> D = Black Dotted E = Repopulated T = Tape and Reel  Leave blank for generic waffle pack.  See packaging definitions on Page 7.

# SLC - Border Cap®

## Border Cap®

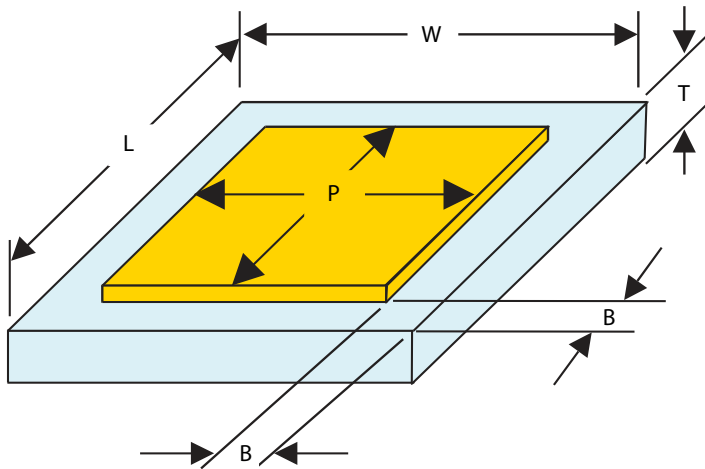

Border Cap®



Double Border Cap®



## Border Cap® Dimensions

Style	Standard Capacitance Range pF	L&W Length & Width		P Pad Size		B Border		T Thickness	
		Inches (±.001)	mm (±.025)	Inches (Nom.)	mm (Nom.)	Inches	mm	Inches	mm
D10	0.02 - 100	0.010	0.254	0.008	0.203	0.001 (+.001,-.0005)	0.025 (+.025,-.013)	0.0035 (+0, -0.008)	0.089 (+0, -0.203)
D12	0.03 - 100	0.012	0.305	0.010	0.254				
D15	0.03 - 200	0.015	0.381	0.011	0.279				
D20	0.06 - 430	0.020	0.508	0.016	0.406				
D25	0.10 - 700	0.025	0.635	0.021	0.533				
D30	0.15 - 1000	0.030	0.762	0.026	0.660	0.002 (+.002,-.0015)	0.051 (+.005, -.038)		
D35	0.20 - 1300	0.035	0.889	0.031	0.787				
D40	0.25 - 1800	0.040	1.016	0.036	0.914				
D50	0.40 - 3000	0.050	1.270	0.046	1.168				

# SLC - Border Cap®

## Ultra High K, UX Dielectric

### 25 Volt Single Border Cap® Cap. Ranges (pF)

Case Size		Available Thicknesses	
		0.006"	0.010"
D10	Min	82	—
	Max	100	—
D12	Min	120	—
	Max	140	—
D15	Min	160	100
	Max	200	140
D20	Min	300	200
	Max	370	240
D25	Min	490	300
	Max	590	370
D30	Min	710	450
	Max	860	540
D35	Min	1000	600
	Max	1200	750
D40	Min	1300	800
	Max	1600	950
D50	Min	2000	1300
	Max	2400	1500

### 25 Volt Double Border Cap® Cap. Ranges (pF)

Case Size		Available Thicknesses	
		0.006"	
D10	Min	75	
	Max	91	
D12	Min	110	
	Max	130	
D15	Min	140	
	Max	170	
D20	Min	270	
	Max	320	
D25	Min	440	
	Max	540	
D30	Min	650	
	Max	800	
D35	Min	900	
	Max	1100	
D40	Min	1200	
	Max	1500	
D50	Min	2000	
	Max	2400	

UX material restricted to "M" termination only. Consult a DLI Application Engineer for additional values.

### 100 Volt Single Border Cap® Capacitance Ranges (pF)

Case Size	pF	DLI Class I Dielectrics													
		PI	PG	AH	CF	NA	CD	NG	CG	DB	NP	NR	NS	NU	NV
D10	Min	0.03	0.04	0.06	0.07	0.07	0.15	0.15	0.25	0.25	0.25	0.50	0.90	1.8	2.7
	Max	0.05	0.06	0.10	0.10	0.10	0.15	0.20	0.35	0.35	0.40	0.80	1.5	3.0	4.3
D12	Min	0.05	0.06	0.09	0.10	0.15	0.20	0.30	0.30	0.35	0.40	0.70	1.3	2.7	3.9
	Max	0.07	0.09	0.10	0.15	0.15	0.25	0.30	0.50	0.50	0.60	1.1	2.2	4.3	6.2
D15	Min	0.06	0.08	0.15	0.15	0.15	0.25	0.30	0.45	0.45	0.55	1.00	1.9	3.9	5.6
	Max	0.09	0.10	0.20	0.20	0.20	0.35	0.40	0.70	0.70	0.85	1.6	3.0	5.6	8.2
D20	Min	0.15	0.15	0.25	0.25	0.25	0.45	0.50	0.80	0.80	0.95	1.8	3.6	6.8	10
	Max	0.15	0.20	0.35	0.40	0.45	0.70	0.80	1.3	1.3	1.6	3.0	5.6	11	16
D25	Min	0.20	0.25	0.40	0.40	0.45	0.70	0.80	1.3	1.3	1.5	3.0	5.6	11	16
	Max	0.30	0.40	0.60	0.65	0.70	1.1	1.3	2.0	2.2	2.4	4.7	9.1	18	27
D30	Min	0.30	0.35	0.55	0.60	0.65	0.95	1.2	1.8	1.9	2.2	4.3	8.2	16	24
	Max	0.45	0.55	0.90	1.0	1.0	1.6	1.9	3.0	3.0	3.6	6.8	13	27	39
D35	Min	0.35	0.50	0.75	0.80	0.85	1.4	1.6	2.7	2.7	3.0	6.2	11	22	33
	Max	0.60	0.80	1.2	1.3	1.5	2.2	2.7	4.3	4.3	5.1	10	18	36	56
D40	Min	0.50	0.65	1.0	1.1	1.2	1.8	2.0	3.3	3.6	4.3	7.5	15	30	43
	Max	0.70	0.95	1.4	1.6	1.7	2.7	3.0	5.1	5.1	6.2	11	22	43	62
D50	Min	0.8	1.0	1.5	1.7	1.8	2.7	3.3	5.1	5.6	6.2	12	22	47	68
	Max	1.1	1.5	2.2	2.4	2.7	4.3	4.7	8.2	8.2	10	18	33	68	100

\*Recommended for commercial use only. Please contact an inside sales representative for additional information.

### 100 Volt Double Border Cap® Capacitance Ranges (pF)

Case Size	pF	DLI Class I Dielectrics													
		PI	PG	AH	CF	NA	CD	NG	CG	DB	NP	NR	NS	NU	NV
D10	Min	0.03	0.04	0.06	0.07	0.07	0.15	0.15	0.20	0.23	0.27	0.45	0.85	1.7	2.7
	Max	0.04	0.06	0.09	0.10	0.10	0.15	0.15	0.30	0.34	0.41	0.70	1.3	2.7	3.9
D12	Min	0.04	0.06	0.09	0.10	0.09	0.15	0.20	0.30	0.33	0.39	0.65	1.3	2.7	3.9
	Max	0.06	0.08	0.10	0.15	0.15	0.25	0.25	0.45	0.51	0.60	1.1	2.0	3.9	6.2
D15	Min	0.06	0.07	0.15	0.15	0.15	0.20	0.25	0.40	0.48	0.56	0.85	1.6	3.3	5.1
	Max	0.08	0.10	0.15	0.15	0.15	0.30	0.35	0.55	0.68	0.80	1.3	2.4	4.7	6.8
D20	Min	0.10	0.15	0.20	0.25	0.25	0.40	0.45	0.70	0.87	1.03	1.6	3.0	6.2	9.1
	Max	0.15	0.20	0.30	0.35	0.35	0.60	0.70	1.1	1.3	1.5	2.4	4.7	9.1	13
D25	Min	0.20	0.25	0.35	0.40	0.40	0.60	0.70	1.2	1.4	1.7	2.7	5.1	10	15
	Max	0.25	0.35	0.50	0.65	0.60	1.0	1.1	1.9	2.1	2.5	4.3	8.2	16	24
D30	Min	0.25	0.35	0.50	0.60	0.55	0.90	1.1	1.7	2.0	2.4	3.9	7.5	15	22
	Max	0.40	0.50	0.80	0.95	0.90	1.5	1.7	2.7	3.1	3.7	6.2	12	24	36
D35	Min	0.35	0.45	0.70	0.80	0.75	1.3	1.5	2.4	2.8	3.3	5.6	10	20	30
	Max	0.55	0.70	1.1	1.3	1.2	2.0	2.4	3.9	4.3	5.1	9.1	16	33	51
D40	Min	0.45	0.60	0.90	1.1	1.0	1.7	1.9	3.3	3.6	4.3	7.5	15	27	43
	Max	0.65	0.90	1.3	1.6	1.5	2.4	2.7	4.7	5.7	6.8	11	20	39	62
D50	Min	0.70	0.95	1.4	1.7	1.6	2.7	3.0	5.1	5.7	6.8	12	22	43	68
	Max	1.1	1.4	2.2	2.4	2.4	3.9	4.7	7.5	9.1	10	16	33	62	100

\*Recommended for commercial use only. Please contact an inside sales representative for additional information.

# SLC - Border Cap®

## Ultra High K, UX Dielectric

### 50 Volt Single Border Cap® Cap. Ranges (pF)

Case Size		Available Thicknesses 0.010"
D10	Min	—
	Max	—
D12	Min	—
	Max	—
D15	Min	100
	Max	140
D20	Min	200
	Max	240
D25	Min	300
	Max	370
D30	Min	450
	Max	540
D35	Min	600
	Max	750
D40	Min	800
	Max	1000
D50	Min	1200
	Max	1500

### 50 Volt Double Border Cap® Cap. Ranges (pF)

Case Size		Available Thicknesses 0.010"
D10	Min	-
	Max	-
D12	Min	-
	Max	-
D15	Min	91
	Max	110
D20	Min	170
	Max	210
D25	Min	280
	Max	340
D30	Min	410
	Max	500
D35	Min	560
	Max	700
D40	Min	750
	Max	900
D50	Min	1200
	Max	1500

UX material restricted to "M" termination only. Consult a DLI Application Engineer for additional values.

DLI Class II Dielectrics								DLI Class III Dielectrics			pF	Case Size
BF*	BD	BG*	BC	BE	BL	BJ	BN	BT*	BU	BV		
1.3	2.2	2.7	3.9	3.6	6.2	10	13	13	27	39	Min	D10
2.2	3.3	4.3	6.2	6.2	10	16	22	22	43	68	Max	
1.9	3.0	3.9	5.6	5.6	9.1	15	20	20	36	62	Min	D12
3.3	5.1	6.2	9.1	9.1	13	24	33	33	62	100	Max	
2.7	4.3	5.6	8.2	8.2	13	20	30	30	56	82	Min	D15
4.3	6.8	8.2	13	12	20	33	43	43	82	130	Max	
5.1	8.2	10	15	15	24	39	51	51	100	150	Min	D20
8.2	13	16	24	22	36	62	82	82	160	240	Max	
8.2	13	16	24	24	36	62	82	82	150	240	Min	D25
13	20	27	39	36	56	100	130	130	240	390	Max	
12	18	24	36	33	56	91	120	120	220	360	Min	D30
20	30	39	56	56	91	150	200	200	360	560	Max	
16	27	33	47	47	75	120	160	160	300	510	Min	D35
27	43	56	75	75	120	200	270	270	510	820	Max	
22	33	43	62	62	100	160	220	220	430	680	Min	D40
33	51	62	91	91	130	240	330	330	620	1000	Max	
33	51	68	100	91	150	270	330	330	620	1000	Min	D50
51	82	100	150	130	220	390	510	510	1000	1500	Max	

DLI Class II Dielectrics								DLI Class III Dielectrics			pF	Case Size
BF*	BD	BG*	BC	BE	BL	BJ	BN	BT*	BU	BV		
1.3	2.0	2.7	3.6	3.6	5.6	9.1	13	13	24	39	Min	D10
2.0	3.0	3.9	5.6	5.6	9.1	15	20	20	39	62	Max	
1.8	3.0	3.9	5.6	5.1	8.2	15	20	20	36	56	Min	D12
3.0	4.7	6.2	8.2	8.2	13	22	30	30	56	91	Max	
2.4	3.9	5.1	6.8	6.8	11	18	24	24	47	75	Min	D15
3.6	5.6	6.8	10	10	16	27	36	36	68	110	Max	
4.7	7.5	9.1	13	13	20	33	47	47	91	150	Min	D20
6.8	11	13	20	20	30	51	68	68	130	220	Max	
7.5	12	15	22	22	33	56	75	75	150	220	Min	D25
12	18	24	33	33	51	82	120	120	220	360	Max	
11	18	22	33	30	51	82	110	110	220	330	Min	D30
18	27	36	51	51	82	130	180	180	330	510	Max	
15	24	30	43	43	68	110	150	150	300	470	Min	D35
24	39	51	68	68	110	180	240	240	470	750	Max	
20	33	43	62	56	91	150	200	200	390	620	Min	D40
30	47	62	82	82	130	220	300	300	560	910	Max	
33	51	68	91	91	150	240	330	330	620	1000	Min	D50
47	75	100	130	130	220	360	470	470	910	1500	Max	

# SLC - T-Cap<sup>®</sup>

T-Cap<sup>®</sup> "Transmission Line" capacitors are designed as a reliable solution in DC Blocking and RF Bypassing applications. The T-Cap<sup>®</sup> products utilize the same Single-Layer processing technology of the Di-Cap<sup>®</sup> product line, with one difference, this device offers a more constant physical size and resonance behavior where dimensional consistency is more desirable than a specified capacitance value.

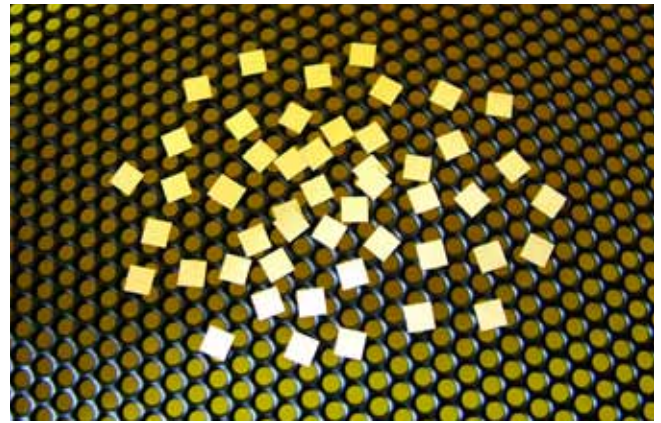

## Description

Transmission Line Single Layer Capacitors

- Consistent electrical resonance performance at microwave frequencies
- Repeatable performance from lot to lot
- Thin Film technology

## Functional Applications

- Filtering • DC Blocking • RF Bypassing • Tuning
- Insulation • Submounts • Stand-Offs

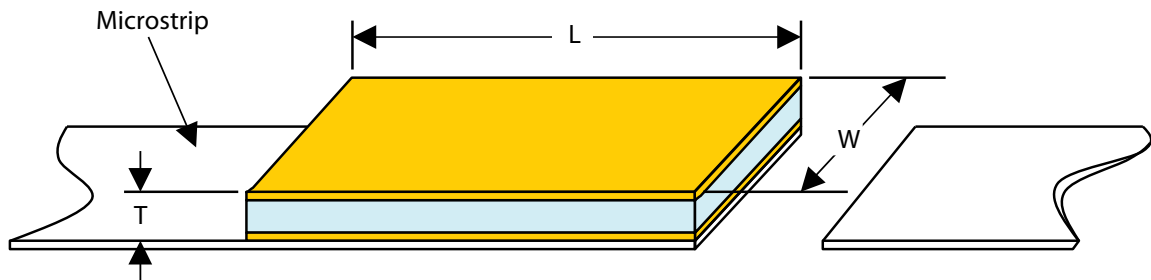

## Part Number Identification

T	30	BV	30	X	45	P	X	
<b>Product</b> T = T-Cap <sup>®</sup>	<b>Width</b> Two digit number representing the Width in .001"  For Widths >.099", Consult an inside sales rep.	<b>Material</b> See material tables on Page 4.	<b>Length</b> Two digit number representing the Length in .001"  For Lengths >.099", Consult an inside sales rep.	<b>Tolerance</b> X= Length and Width: ± .001", Thickness: -.0005" S= Special	<b>Thickness</b> "35" - "99" Represents thickness in .0001"  K0 = .010" M0 = .020"  Examples: 55 = .0055" K2 = .012" M5 = .025"	<b>Termination</b> P = Ni / Au T = Ni / AuSn M = Au	<b>Test Level</b> Y or X  See test level definitions on Page 6.	<b>Packaging</b> D = Black Dotted E = Repopulated T = Tape and Reel  Leave blank for generic waffle pack.  See packaging definitions on Page 7.

# SLC - Di-Cap®

High Performance Single Layer Capacitors for RF, Microwave and Millimeter-Wave Applications.

- Gold metallization for wire bonding
- Rugged construction
- Custom sizes at commercial prices
- Thin film technology
- ESD proof

## Functional Applications

- DC Blocking
- RF Bypass
- Filtering
- Tuning

## Di-Cap®

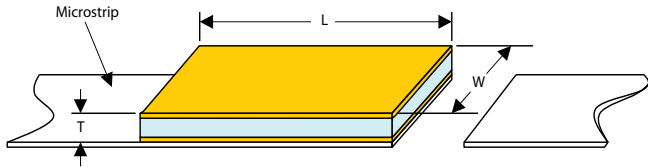

**Dimensions** Maximum thickness does not apply for capacitance values below 0.5pF. For thickness of 25 Volt product refer to table on page 14.

Style	W Width		L Length (Max)		T Thickness (50 Volts)		T Thickness (100 Volts)		Std. Capacitor Range pF
	Inches	mm	Inches	mm	Inches	mm	Inches	mm	
D10	.010 +.000 -.003	.254 +.000 -.076	.010	.254	.004 ±.001	.102 ±.025	-	-	.02 - 100
D12	.012 +.002 -.003	.305 +.051 -.076	.015	.381	.004 ±.001	.102 ±.025	-	-	.03 - 200
D15	.015 +.000 -.003	.381 +.000 -.076	.020	.508	.004 ±.001	.102 ±.025	.006 ±.001	.152 ±.025	.04 - 300
D20	.020 +.000 -.003	.508 +.000 -.076	.020	.508	.004 ±.001	.102 ±.025	.006 ±.001	.152 ±.025	.06 - 400
D25	.025 +.000 -.003	.635 +.000 -.076	.030	.762	.004 ±.001	.102 ±.025	.006 ±.001	.152 ±.025	.10 - 780
D30	.030 +.000 -.003	.762 +.000 -.076	.030	.762	.004 ±.001	.102 ±.025	.006 ±.001	.152 ±.025	.15 - 950
D35	.035 ±.005	.889 ±.127	.040	1.016	.004 ±.001	.102 ±.025	.007 ±.002	.178 ±.051	.20 - 1600
D50	.050 ±.010	1.270 ±.254	.060	1.524	-	-	.007 ±.002	.178 ±.051	.30 - 3700
D70	.070 ±.010	1.778 ±.254	.080	1.778	-	-	.008 ±.002	.203 ±.051	.55 - 6800
D90	.090 ±.010	2.286 ±.254	.100	2.540	-	-	.010 ±.004	.254 ±.102	.65 - 10,000

## Leaded Di-Cap®

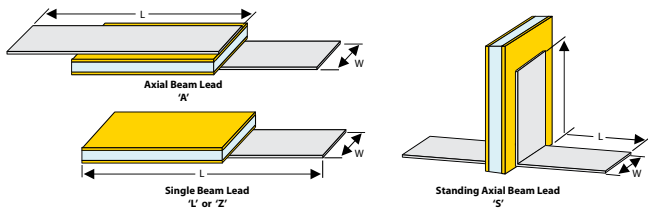

**Notes:** • See Di-Cap® Termination Code Table for available lead configurations. • Lead material is 0.002" pure silver, (Ag), 0.002" ±.0005" thick. • Leads are attached with AuSn, 80%/20% eutectic alloy. Re-flow temperature is 280°C minimum. • Pure Gold, (Au) leads are available. Consult factory for details. • Chip dimensions per Di-Cap® dimensions table. • Custom lead dimensions are available. Consult factory for details.

## Dimensions

Style	W Lead Width (Min)		W Lead Width (Max)		L Lead Length (Min)	
	Inches	mm	Inches	mm	Inches	mm
D10	.0035	.0889	.007	.1778	.250	6.350
D12	.0045	.1143	.009	.2286	.250	6.350
D15	.0065	.1651	.013	.3302	.250	6.350
D20	.0085	.2159	.017	.2159	.250	6.350
D25	.011	.2794	.022	.5588	.250	6.350
D30	.0135	.3429	.027	.6858	.250	6.350
D35	.015	.381	.030	.762	.250	6.350
D50	.020	.508	.040	1.016	.250	6.350
D70	.030	.762	.060	1.524	.250	6.350
D90	.040	1.016	.080	2.032	.250	6.350

## Part Number Identification

D	10	CF	OR1	B	5	P	X	
<b>Product</b> D = Di-Cap®	<b>Case Size</b> 10 12 15 20 25 30 35 50 70 90	<b>Material</b> See material tables on Page 4.	<b>Capacitance (pF)</b> R02 = 0.02pF OR5 = 0.5pF 1R0 = 1.0pF 5R1 = 5.1pF 100 = 10pF 101 = 100pF 432 = 4300pF  Refer to Capacitance range tables for available values. Consult an inside sales rep. for custom solutions.	<b>Tolerance</b> A = ± 0.05pF B = ± 0.10pF C = ± 0.25pF D = ± 0.5pF F = ± 1% G = ± 2% J = ± 5% K = ± 10% L = ± 15% M = ± 20% Z = +80% -20%	<b>Voltage</b> 2 = 25V 5 = 50V 1 = 100V	<b>Termination</b> P = Ni / Au T = Ni / AuSn M = Au L = Single Beam Lead A = Axial Beam Lead S = Standing Axial Beam Lead D = Special Z = Tin Copper Ribbon	<b>Test Level</b> Y, X, A, B, D and E.  See test level definitions on Page 6.	<b>Packaging</b> D = Black Dotted E = Repopulated T = Tape and Reel  Leave blank for generic waffle pack.  See packaging definitions on Page 7.

# SLC - Di-Cap®

## Ultra High K, UX\* Dielectric Di-Cap®

### 25 Volt Capacitance Ranges (pF)

Case Size		Available Thicknesses	
		0.006"	0.010"
D10	Min	51	—
	Max	75	—
D12	Min	75	—
	Max	180	—
D15	Min	110	—
	Max	250	—
D20	Min	170	100
	Max	340	200
D25	Min	280	170
	Max	650	390
D30	Min	390	240
	Max	800	470
D35	Min	620	360
	Max	1400	850
D50	Min	1600	940
	Max	3200	2000
D70	Min	3500	2100
	Max	5900	3500
D90	Min	6200	3700
	Max	10000	5500

### 50 Volt Capacitance Ranges (pF)

Case Size		Available Thicknesses	
		0.010"	
D10	Min	—	—
	Max	—	—
D12	Min	—	—
	Max	—	—
D15	Min	82	—
	Max	150	—
D20	Min	100	—
	Max	200	—
D25	Min	170	—
	Max	390	—
D30	Min	240	—
	Max	470	—
D35	Min	360	—
	Max	850	—
D50	Min	940	—
	Max	2000	—
D70	Min	2100	—
	Max	3500	—
D90	Min	3700	—
	Max	5500	—

\*UX material restricted to "M" termination only.

### 50 Volt Di-Cap® Capacitance Ranges (pF)

Case Size	pF	DLI Class I Dielectrics													
		PI	PG	AH	CF	NA	CD	NG	CG	DB	NP	NR	NS	NU	NV
D10	Min	0.03	0.04	0.06	0.07	0.06	0.10	0.15	0.20	0.20	0.25	0.45	0.80	1.6	2.4
	Max	0.05	0.06	0.10	0.10	0.10	0.15	0.20	0.35	0.35	0.40	0.80	1.5	3.0	4.3
D12	Min	0.04	0.06	0.08	0.10	0.09	0.15	0.20	0.30	0.30	0.35	0.65	1.2	2.4	3.6
	Max	0.10	0.10	0.20	0.25	0.20	0.35	0.45	0.75	0.75	0.90	1.7	3.0	6.2	9.1
D15	Min	0.06	0.08	0.15	0.15	0.15	0.25	0.25	0.45	0.45	0.50	1.0	1.8	3.6	5.6
	Max	0.15	0.20	0.30	0.35	0.30	0.55	0.65	1.1	1.1	1.3	2.4	4.7	9.1	13
D20	Min	0.09	0.15	0.20	0.20	0.20	0.35	0.40	0.65	0.65	0.75	1.5	2.7	5.6	8.2
	Max	0.20	0.25	0.40	0.50	0.45	0.75	0.90	1.4	1.5	1.8	3.3	6.2	12	18
D25	Min	0.20	0.25	0.35	0.45	0.40	0.65	0.75	1.2	1.3	1.5	2.7	5.1	11	16
	Max	0.40	0.50	0.80	0.95	0.90	1.5	1.7	2.7	2.7	3.3	6.2	12	24	36
D30	Min	0.25	0.30	0.45	0.55	0.50	0.85	0.95	1.6	1.6	1.9	3.6	6.8	15	20
	Max	0.45	0.60	0.95	1.1	1.0	1.8	2.0	3.3	3.3	3.9	7.5	13	27	43
D35	Min	0.35	0.50	0.70	0.85	0.80	1.3	1.5	2.7	2.7	3.0	5.6	11	22	33
	Max	0.85	1.1	1.8	2.0	1.9	3.3	3.6	6.2	6.2	7.5	13	27	51	75

\*Recommended for commercial use only. Please contact an inside sales representative for additional information.

### 100 Volt Di-Cap® Capacitance Ranges (pF)

Case Size	pF	DLI Class I Dielectrics													
		PI	PG	AH	CF	NA	CD	NG	CG	DB	NP	NR	NS	NU	NV
D15	Min	0.04	0.06	0.08	0.1	0.09	0.15	0.20	0.30	0.30	0.35	0.65	1.2	2.4	3.6
	Max	0.10	0.10	0.20	0.25	0.20	0.35	0.45	0.70	0.75	0.85	1.6	3.0	6.2	9.1
D20	Min	0.06	0.08	0.15	0.15	0.15	0.25	0.30	0.45	0.45	0.55	1.0	1.9	3.9	5.6
	Max	0.10	0.15	0.25	0.30	0.30	0.50	0.60	0.95	1.0	1.2	2.2	3.9	8.2	12
D25	Min	0.15	0.20	0.25	0.30	0.30	0.45	0.50	0.85	0.85	1.0	1.9	3.6	7.5	11
	Max	0.25	0.35	0.50	0.65	0.60	1.0	1.1	1.9	1.9	2.2	4.3	8.2	16	24
D30	Min	0.15	0.20	0.35	0.40	0.35	0.60	0.65	1.1	1.1	1.3	2.7	4.7	9.1	15
	Max	0.30	0.40	0.65	0.75	0.70	1.2	1.4	2.2	2.2	2.7	5.1	9.1	18	27
D35	Min	0.20	0.25	0.40	0.45	0.45	0.70	0.80	1.3	1.4	1.6	3.0	5.6	12	18
	Max	0.55	0.75	1.2	1.4	1.3	2.2	2.4	3.9	4.3	5.1	9.1	18	36	51
D50	Min	0.50	0.60	0.95	1.1	1.1	1.7	2.0	3.3	3.3	3.9	7.5	15	30	43
	Max	1.3	1.7	2.7	3.0	3.0	4.7	5.6	9.1	9.1	11	20	39	82	120
D70	Min	0.95	1.2	1.9	2.4	2.2	3.6	4.3	6.8	6.8	8	15	30	56	91
	Max	2.0	2.7	3.9	4.7	4.3	7.5	8.2	13	15	16	33	62	120	180
D90	Min	1.2	1.5	2.4	3.0	2.7	4.3	5.1	8.2	8.2	10	20	36	68	110
	Max	3.0	3.9	6.2	7.5	6.8	12	13	22	22	27	51	91	180	270

\*Recommended for commercial use only. Please contact an inside sales representative for additional information.



# SLC - Di-Cap<sup>®</sup>

## Di-Cap<sup>®</sup> Designer Kits 160 Capacitors, 10 Each of 16 Values

Part Number	Capacitor Width	10 Capacitors of each value								
		Dielectric	pF	Tol.	pF	Tol.	pF	Tol.	pF	Tol.
D10XXKITA5PX	.010"	Class I, see codes on Page 4	0.1	B	0.6	C	1.5	C	2.7	D
			0.4	B	1	C	2.2	D	3.3	D
		Class II, see codes on Page 4	3.9	D	5.6	M	8.2	M	20	M
			4.7	D	6.2	M	10	M	33	M
D15XXKITA5PX D20XXKITA5PX	.015" .020"	Class I, see codes on Page 4	0.1	B	0.6	C	1.5	C	3.3	D
			0.4	B	1.0	C	2.2	C	5.6	D
		Class II, see codes on Page 4	6.8	K	10	K	20	M	50	M
			8.2	K	15	K	33	M	100	M
D25XXKITA5PX D30XXKITA5PX	.025" .030"	Class I, see codes on Page 4	0.4	B	1.5	C	3.3	D	8.2	K
			0.6	C	2.2	C	4.76	D	10	K
			1.0	C	2.7	C	5.6	D	20	K
		Class II, see codes on Page 4	33	M	50	M	100	M	180	M

DLI reserves the right to substitute values as required.  
Customer may request particular cap value and material for sample kits.

DLI Class II Dielectrics								DLI Class III Dielectrics			pF	Case Size
BF*	BD	BG*	BC	BE	BL	BJ	BN	BT*	BU	BV		
1.2	1.8	2.4	3.6	3.3	5.6	9.1	12	12	22	36	Min	D10
2.2	3.6	4.3	6.2	6.2	10	16	22	22	43	68	Max	
1.8	3.0	3.6	5.1	5.1	8.2	13	18	18	36	56	Min	D12
4.7	7.5	9.1	13	13	20	33	47	47	91	130	Max	
2.7	4.3	5.6	7.5	7.5	12	20	27	27	51	82	Min	D15
6.8	11	13	20	18	30	51	68	68	130	200	Max	
4.3	6.2	8.2	12	12	18	30	43	43	75	120	Min	D20
9.1	13	18	27	24	39	68	91	91	180	270	Max	
8	12	16	22	22	36	56	82	82	150	240	Min	D25
18	27	36	51	51	82	130	180	180	330	510	Max	
10	16	20	30	30	47	75	100	100	200	300	Min	D30
22	33	43	62	62	91	160	220	220	390	620	Max	
16	27	33	47	47	75	120	160	160	300	510	Min	D35
39	62	75	110	110	180	270	390	390	750	1200	Max	

DLI Class II Dielectrics								DLI Class III Dielectrics			pF	Case Size
BF*	BD	BG*	BC	BE	BL	BJ	BN	BT*	BU	BV		
1.8	3.0	3.6	5.6	5.1	8.2	13	18	18	36	56	Min	D15
4.3	6.8	9.1	13	13	20	33	47	47	82	130	Max	
2.7	4.3	5.6	8	8	13	20	30	30	56	82	Min	D20
6.2	9	12	18	16	27	47	62	62	120	180	Max	
5.6	8	11	16	15	24	39	56	56	100	160	Min	D25
12	18	24	33	33	51	82	120	120	220	360	Max	
6.8	11	15	20	20	33	51	68	68	130	220	Min	D30
13	22	27	43	39	62	100	130	130	270	430	Max	
9.1	13	18	24	24	39	62	91	91	160	270	Min	D35
24	39	51	75	75	120	180	270	270	510	750	Max	
22	33	43	62	62	100	160	220	220	390	620	Min	D50
56	91	120	160	160	270	430	560	560	1100	1800	Max	
43	68	91	120	120	200	330	430	430	820	1300	Min	D70
91	130	180	270	240	390	680	910	910	1600	2700	Max	
51	82	110	150	150	240	390	510	510	1000	1600	Min	D90
130	220	270	390	390	620	1000	1300	1300	2700	4300	Max	

# SLC - Bar Cap®

Bar Caps are specifically designed for MMIC circuits requiring multiple capacitor applications, such as Multiple Decoupling or RF Bypassing Networks. Multiple capacitor array devices have become an integral circuit component due to their High Q and low inductance.

## Description

Multiple Decoupling/Blocking Capacitors in a Single Array

- Can be integrated into IC package to reduce bond wire lengths and improve performance
- Single insertion reduces complexity and costs
- Simplified assembly

## Functional Applications

- RF Bypass • DC Blocking for GaAs IC's • Decoupling



## Bar Cap® Dimensions

Case size	No. Caps	W Width		L Length		Nom Pad Size	
		Inches (± 0.003)	mm (± 0.076)	Inches (±0.005)	mm (±0.127)	Inches	mm
E20	3	0.02	0.508	0.065	1.651	0.02	0.508
	4			0.085	2.159		
	6			0.125	3.175		
E25	3	0.025	0.635	0.065	1.651	0.025	0.635
	4			0.085	2.159		
	6			0.125	3.175		
E30	3	0.03	0.762	0.065	1.651	0.03	0.762
	4			0.085	2.159		
	6			0.125	3.175		
E40	3	0.04	1.016	0.065	1.651	0.04	1.016
	4			0.085	2.159		
	6			0.125	3.175		

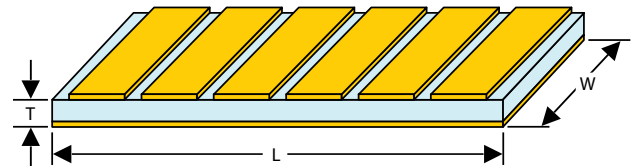

## Ultra High K, UX Dielectric 25 Volt Bar Cap® Capacitance Ranges (pF)

Case Size	No. Caps	Each Cap (pF) T Thickness	
		0.006"	0.010"
E20	3	340	-
	4		
	6		
E25	3	420	270
	4		
	6		
E30	3	500	320
	4		
	6		
E40	3	690	430
	4		
	6		

## Class III, BU Dielectric 100 Volt Bar Cap® Capacitance Ranges (pF)

Case Size	No. Caps	Each Cap (pF) T Thickness
		0.007" (0.178mm)
E20	3	80
	4	
	6	
E25	3	100
	4	
	6	
E30	3	120
	4	
	6	
E40	3	150
	4	
	6	

## Part Number Identification

E	40	BU	151	Z	1	P	X	4	
<b>Product</b> E = Bar Capacitors	<b>Case Size</b> 20 25 30 40	<b>Material</b> See material tables on Page 4.	<b>Capacitance (pF)</b> 800 = 80 pF 101 = 100 pF 121 = 120 pF 151 = 150 pF  Consult an inside sales rep. for custom solutions.	<b>Tolerance</b> Z = +80% -20%	<b>Voltage</b> 2 = 25V 5 = 50V	<b>Termination</b> P = Ni / Au M = Au	<b>Test Level</b> Y or X  See test level definitions on Page 6.	<b>Capacitor Quantity</b> In mils 3 4 6 Etc.	<b>Packaging</b> D = Black Dotted E = Repopulated T = Tape and Reel  Leave blank for generic waffle pack.  See packaging definitions on Page 7.

\*Custom Solutions are available; however additional tooling costs may apply. Please contact the sales office for more information.

# SLC - Gap Cap<sup>®</sup>

Series Configured Capacitors for Microwave Applications. Gap Caps are designed for DC Blocking and RF Bypassing. The low insertion loss and high resonant frequencies make it an ideal device for this type of application. This product's unique configuration eliminates the need for wirebonding, therefore reducing performance variations.

## Description

- Consistent performance
- Coplanar waveguide
- Gap Cap configuration eliminates wirebonding

## Functional Applications

- DC Blocking
- RF Bypass
- Elimination of wirebond

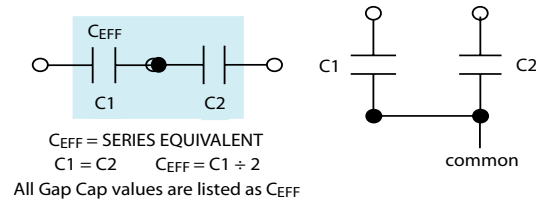
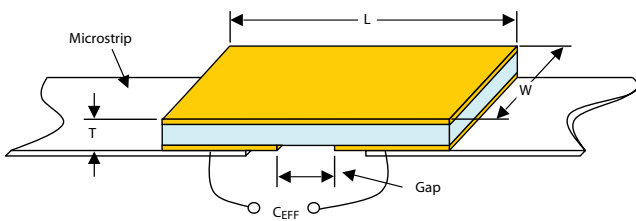
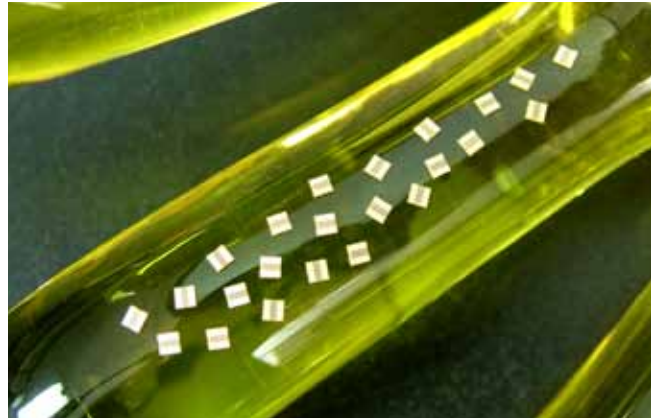

## Gap Cap Designer Kits 160 Capacitors, 10 Each of 16 Values

Part Number	Capacitor Width	10 Capacitors of each value								
		Dielectric	pF	Tol.	pF	Tol.	pF	Tol.	pF	Tol.
G10XXKITAPX05	.010"	Class I, see codes on Page 4	0.05	A	0.2	A	0.4	A	0.6	C
			0.14	A	0.3	A	0.5	B	0.8	C
		Class II, see codes on Page 4	1	C	2.2	D	5.6	M	10	M
			1.5	C	4.7	M	8.2	M	15	M
G15XXKITAPX08 G20XXKITAPX10	.015"	Class I, see codes on Page 4	0.08	A	0.4	A	0.6	B	1.5	D
			0.2	A	0.5	B	1	C	2.2	D
	Class II, see codes on Page 4	3.3	D	5.6	M	8.2	M	15	M	
		4.7	M	6.8	M	10	M	20	M	
G25XXKITAPX10	.025"	Class I, see codes on Page 4	0.4	A	0.77	B	1.5	C	3.3	D
			0.5	B	1	C	2.2	D	4.7	D
		Class II, see codes on Page 4	5.6	M	8.2	M	15	M	33	M
			6.8	M	10	M	20	M	51	M

DLI reserves the right to substitute values as required. Customer may request particular cap value and material for sample kits.

## Part Number Identification

G	10	BU	100	K	5	P	X	10	
<b>Product</b> G = GAP Cap <sup>®</sup>	<b>Case Size</b> 10 15 20 25 30 35 50	<b>Material</b> See material tables on Page 4.	<b>Capacitance (pF)</b> R01 = 0.01 pF 0R5 = 0.5 pF 1R0 = 1.0 pF 5R1 = 5.1 pF 100 = 10 pF 511 = 510 pF  Refer to Capacitance range tables for available values. Consult an inside sales rep. for custom solutions.	<b>Tolerance</b> A = ± 0.05pF B = ± 0.10pF C = ± 0.25pF D = ± 0.5pF F = ± 1% G = ± 2% J = ± 5% K = ± 10% L = ± 15% M = ± 20% Z = +80% -20%	<b>Voltage</b> 2 = 25V 5 = 50V	<b>Termination</b> P = Ni / Au M = Au	<b>Test Level</b> Y, X, A, B, D and E.  See test level definitions on page 6.	<b>Gap Width</b> In mils 5 8 10 15	<b>Packaging</b> D = Black Dotted E = Repopulated T = Tape and Reel  Leave blank for generic waffle pack.  See packaging definitions on Page 7.

# SLC - Gap Cap®

Ultra High K, UX Dielectric

25 Volt Single Gap Cap® Cap. Ranges (pF)

Case Size		Available Thicknesses	
		0.006"	0.010"
G10	Min	40	—
	Max	60	—
G15	Min	90	60
	Max	120	70
G20	Min	150	90
	Max	200	120
G25	Min	190	140
	Max	250	160
G30	Min	265	180
	Max	300	190
G35	Min	310	200
	Max	350	250
G50	Min	500	380
	Max	800	550

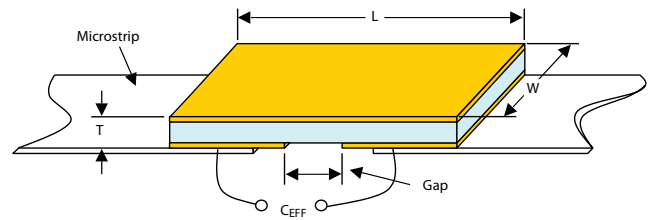

25 Volt Gap Cap® Capacitance Ranges (pF)

Case Size	Std. Gap	pF	DLI Class I Dielectrics														
			PI	PG	AH	CF	NA	CD	NG	CG	DB	NP	NR	NS	NU	NV	
G10	.005"	Min	0.02	0.02	0.04	0.04	0.04	0.06	0.07	0.15	0.15	0.15	0.25	0.50	0.95	1.4	
		Max	0.03	0.05	0.08	0.09	0.08	0.10	0.15	0.15	0.25	0.25	0.30	0.60	1.2	2.4	3.6
G15	.008"	Min	0.03	0.04	0.06	0.08	0.07	0.15	0.15	0.25	0.25	0.25	0.30	0.50	0.90	1.8	2.7
		Max	0.07	0.10	0.15	0.15	0.15	0.25	0.30	0.50	0.55	0.65	1.2	2.2	4.3	6.8	
G20	.010"	Min	0.04	0.05	0.08	0.10	0.09	0.15	0.20	0.30	0.30	0.35	0.65	1.2	2.4	3.6	
		Max	0.10	0.15	0.25	0.30	0.25	0.45	0.55	0.90	0.90	1.1	2.0	3.9	7.5	11	
G25	.020"	Min	0.05	0.07	0.10	0.15	0.15	0.20	0.20	0.35	0.35	0.40	0.75	1.4	3.0	4.3	
		Max	0.15	0.20	0.30	0.35	0.35	0.60	0.65	1.1	1.1	1.3	2.4	4.7	9.1	13	
G30	.020"	Min	0.06	0.08	0.15	0.15	0.15	0.25	0.30	0.45	0.45	0.55	0.95	1.8	3.6	5.6	
		Max	0.15	0.25	0.35	0.45	0.40	0.70	0.80	1.3	1.4	1.6	3.0	5.6	11	16	
G35	.020"	Min	0.07	0.09	0.15	0.20	0.15	0.30	0.30	0.50	0.50	0.60	1.1	2.2	4.3	6.2	
		Max	0.20	0.25	0.45	0.50	0.50	0.80	0.95	1.6	1.6	1.9	3.6	6.8	13	20	

50 Volt Gap Cap® Capacitance Ranges (pF)

Case Size	Std. Gap	pF	DLI Class I Dielectrics														
			LA	PI	PG	AH	CF	NA	CD	NG	CG	DB	NP	NR	NS	NU	NV
G10	.005"	Min	0.01	0.02	0.02	0.03	0.03	0.03	0.04	0.05	0.08	0.08	0.09	0.20	0.35	0.65	0.95
		Max	0.01	0.02	0.03	0.05	0.06	0.05	0.09	0.10	0.15	0.15	0.20	0.40	0.80	1.6	2.4
G15	.008"	Min	0.02	0.03	0.03	0.05	0.06	0.05	0.08	0.10	0.15	0.20	0.20	0.35	0.65	1.3	2.0
		Max	0.02	0.05	0.06	0.10	0.10	0.10	0.15	0.20	0.35	0.35	0.40	0.80	1.5	3.0	4.7
G20	.010"	Min	0.02	0.03	0.04	0.06	0.07	0.07	0.15	0.15	0.20	0.25	0.25	0.45	0.85	1.7	2.7
		Max	0.04	0.08	0.10	0.15	0.20	0.15	0.30	0.35	0.60	0.60	0.70	1.3	2.4	5.1	7.5
G25	.020"	Min	0.03	0.04	0.05	0.08	0.09	0.08	0.15	0.20	0.30	0.30	0.35	0.60	1.1	2.2	3.3
		Max	0.09	0.15	0.20	0.30	0.35	0.35	0.55	0.65	1.1	1.1	1.3	2.4	4.7	9.1	13
G30	.020"	Min	0.03	0.05	0.07	0.10	0.15	0.15	0.20	0.20	0.35	0.35	0.40	0.75	1.4	3.0	4.3
		Max	0.10	0.15	0.25	0.35	0.45	0.40	0.70	0.80	1.3	1.3	1.6	3.0	5.6	11	16
D35	.020"	Min	0.04	0.06	0.07	0.15	0.15	0.15	0.20	0.25	0.40	0.40	0.50	0.90	1.6	3.3	5.1
		Max	0.10	0.20	0.25	0.45	0.5	0.45	0.80	0.95	1.5	1.6	1.9	3.6	6.2	13	20
G50	.020"	Min	0.04	0.07	0.09	0.15	0.20	0.20	0.30	0.30	0.50	0.50	0.60	1.2	2.2	4.3	6.2
		Max	0.20	0.35	0.50	0.75	0.90	0.85	1.4	1.6	2.7	2.7	3.3	6.2	11	22	33

\*Recommended for commercial use only. Please contact an inside sales representative for additional information.

# SLC - Gap Cap®

## 25 Volt Gap Cap® Dimensions

Style	G Gap (Nom.)		W Width		L Length (Max)		T Thickness Range*	
	Inches	mm	Inches	mm	Inches	mm	Inches (±0.001)	mm (± 0.025)
G10	0.005	0.127	0.010 +0 -0.003	0.254 +0 -0.076	0.030	0.762	0.004	0.102
G15	0.008	0.203	0.015 +0 -0.003	0.381 +0 -0.076	0.040	1.016	0.004	0.102
G20	0.010	0.254	0.020 +0 -0.003	0.508 +0 -0.076	0.050	1.270	0.004	0.102
G25	0.020	0.508	0.025 +0 -0.003	0.635 +0 -0.076	0.060	1.524	0.004	0.102
G30	0.020	0.508	0.030 +0 -0.003	0.762 +0 -0.076	0.060	1.524	0.004	0.102
G35	0.020	0.508	0.035 ±0.005	0.889 ±0.127	0.060	1.524	0.004	0.102
G50	0.020	.0508	0.05 ±0.010	1.270 ±0.254	0.080	2.032	0.006	0.152

\*UX thickness only available in .006" and .010".

## 50 Volt Gap Cap® Dimensions

Style	G Gap (Nom.)		W Width		L Length (Max)		T Thickness Range	
	Inches	mm	Inches	mm	Inches	mm	Inches (±0.001)	mm (± 0.025)
G10	0.005	0.127	0.010 +0 -0.003	0.254 +0 -0.076	0.030	0.762	0.006	0.152
G15	0.008	0.203	0.015 +0 -0.003	0.381 +0 -0.076	0.040	1.016	0.006	0.152
G20	0.010	0.254	0.020 +0 -0.003	0.508 +0 -0.076	0.050	1.270	0.006	0.152
G25	0.020	0.508	0.025 +0 -0.003	0.635 +0 -0.076	0.080	2.032	0.006	0.152
G30	0.020	0.508	0.030 +0 -0.003	0.762 +0 -0.076	0.080	2.032	0.006	0.152
G35	0.020	0.508	0.035 ±0.005	0.889 ±0.127	0.080	2.032	0.006	0.152
G50	0.020	.0508	0.05 ±0.010	1.270 ±0.254	0.080	2.032	0.006	0.152

DLI Class II Dielectrics								DLI Class III Dielectrics			pF	Std. Gap	Case Size
BF*	BD	BG*	BC	BE	BL	BJ	BN	BT*	BU	BV			
0.70	1.1	1.4	2.0	2.0	3.3	5.1	7.5	7.5	15	22	Min	.005"	G10
1.7	2.7	3.6	5.1	4.7	7.5	13	18	18	33	51	Max		
1.4	2.2	2.7	3.9	3.9	6.2	10	15	15	27	43	Min	.008"	G15
3.3	5.1	6.8	10	9.1	15	24	33	33	62	100	Max		
1.7	2.7	3.6	5.1	5.1	8.2	13	18	18	33	51	Min	.010"	G20
5.6	9.1	11	16	16	24	43	56	56	110	160	Max		
2.2	3.3	4.3	6.2	6.2	10	16	22	22	43	68	Min	.020"	G25
6.8	11	13	20	20	30	51	68	68	130	200	Max		
2.7	4.3	5.6	8.2	7.5	12	20	27	27	51	82	Min	.020"	G30
8.2	13	16	24	24	39	62	82	82	160	240	Max		
3.3	5.1	6.2	9.1	9.1	15	24	33	33	62	100	Min	.020"	G35
10	16	20	27	27	43	75	100	100	180	300	Max		

DLI Class II Dielectrics								DLI Class III Dielectrics			pF	Std. Gap	Case Size
BF*	BD	BG*	BC	BE	BL	BJ	BN	BT*	BU	BV			
0.50	0.75	0.95	1.4	1.4	2.2	3.6	5.1	5.1	9.1	15	Min	.005"	G10
1.1	1.8	2.4	3.3	3.3	5.1	8.2	12	12	22	36	Max		
0.95	1.5	2.0	3.0	2.7	4.3	7.5	10	10	20	30	Min	.008"	G15
2.2	3.6	4.7	6.8	6.2	10	16	22	22	43	68	Max		
1.3	2.0	2.7	3.9	3.6	6.2	10	13	13	24	39	Min	.010"	G20
3.6	5.6	7.5	11	10	16	27	39	39	68	110	Max		
1.7	2.7	3.3	4.7	4.7	7.5	12	18	18	33	51	Min	.020"	G25
6.8	11	13	20	20	30	51	68	68	130	200	Max		
2.2	3.3	4.3	6.2	6.2	10	16	22	22	43	68	Min	.020"	G30
8.2	13	16	24	24	36	62	82	82	160	240	Max		
2.4	3.9	5.1	7.5	6.8	11	18	24	24	47	75	Min	.020"	G35
10	15	20	27	27	43	68	100	100	180	300	Max		
3.3	5.1	6.2	9.1	9.1	15	24	33	33	62	100	Min	.020"	G50
16	27	33	51	47	75	120	160	160	330	510	Max		

# SLC - Bi-Cap<sup>®</sup>

## Description

Binary Tunable Caps for SLC Hybrids.

- Small size is compatible with microwave geometries
- Ideal for prototype circuits

## Functional Applications

- Matching Networks
- Tank Circuits
- Dielectric resonator tuning/coupling

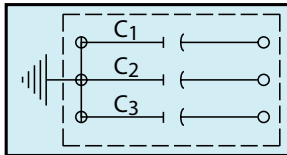
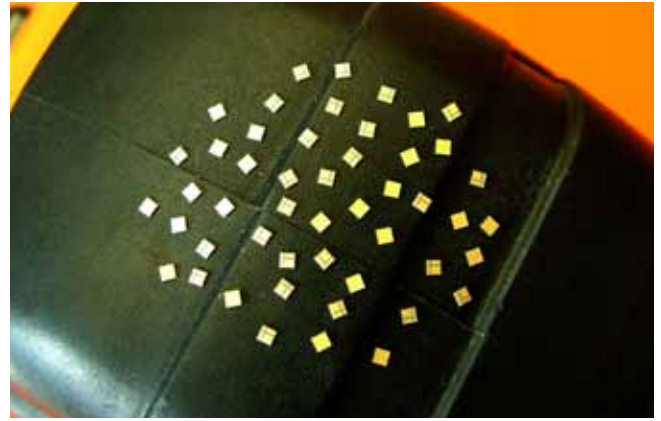

$C_1 = 1$   
 $C_2 = 2 \times C_1$   
 $C_3 = 4 \times C_1$   
 (4 pad -  $C_4 = 8 \times C_1$ )  
 Pads may be used singularly or in combination to tune circuit.

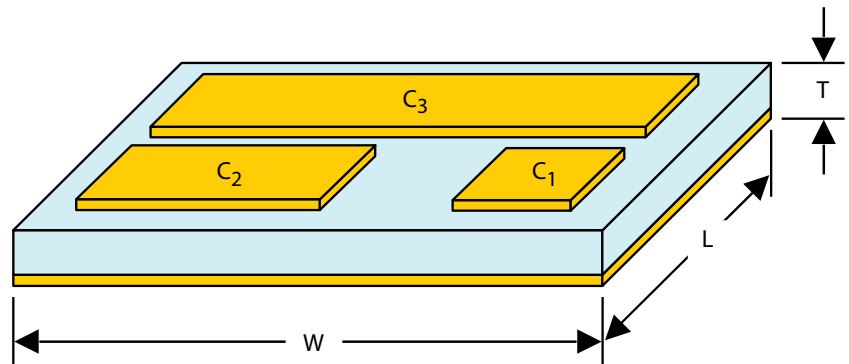

## Bi-Cap<sup>®</sup> Dimensions and Part Numbers

Part Number	No. Caps	Each Cap (pF)	L & W Length & Width		T Thickness		B Border		Voltage Rating (Volts)
			Inches (±.001)	mm (±.025)	Inches (±.001)	mm (±.025)	Inches (±.002)	mm (±.051)	
F15CGR08M5PX3	3	.080, .15, .3	0.015	0.381	0.004	0.102	0.002	0.0051	50
F15NR0R1M1PX3	3	.1, .2, .4	0.015	0.381	0.006	0.152	0.002	0.0051	100
F20CG0R1M1PX3	3	.1, .2, .4	0.020	0.508	0.006	0.152	0.002	0.0051	100
F20NR0R2M1PX3	3	.2, .4, .8	0.020	0.508	0.006	0.152	0.002	0.0051	100
F25CFR08M5PX3	3	.080, .15, .3	0.025	0.635	0.004	0.102	0.002	0.0051	50
F25CG0R2M1PX3	3	.2, .4, .8	0.025	0.635	0.006	0.152	0.002	0.0051	100
F25NR0R4M1PX3	3	.4, .8, 1.6	0.025	0.635	0.006	0.152	0.002	0.0051	100
F35CF0R1M1PX3	3	.1, .2, .4	0.035	0.889	0.006	0.152	0.002	0.0051	100
F35CG0R4M1PX3	3	.1, .2, .4	0.035	0.889	0.006	0.152	0.002	0.0051	100
F40NR0R5M1PX4	4	.5, 1, 2, 4	0.040	1.016	0.0075	0.191	0.002	0.0051	100

\*Custom Solutions are available; however additional tooling costs may apply. Please contact an inside sales representative for more information.

## Part Number Identification

F	15	NR	OR1	M	1	P	X	3	
<b>Product</b> F = Binary Capacitors	<b>Case Size</b> 15 20 25 35 40	<b>Material</b> See material tables on Page 4.	<b>Capacitance (pF)</b> Lowest Value in Series is Part Number R08 = .080 pF OR1 = .1 pF OR2 = .2 pF OR4 = .4 pF OR5 = .5 pF  Consult an inside sales rep. for custom solutions.	<b>Tolerance</b> M = ±20%	<b>Voltage</b> 2 = 25V 5 = 50V 1 = 100V	<b>Termination</b> P = Ni / Au M = Au	<b>Test Level</b> Y or X  See test level definitions on Page 6.	<b>Pad Quantity</b> 3 4	<b>Packaging</b> D = Black Dotted E = Repopulated T = Tape and Reel  Leave blank for generic waffle pack.  See packaging definitions on Page 7.

# SLC - Heatsinks, Standoffs & Submounts

## Heatsinks

- Heatsinks are fully metallized on all sides and are used to dissipate and absorb heat
- Heatsinks allow for high thermal conductivity and are electrically conductive (DC short)
- Typically used with LED's or laser diodes

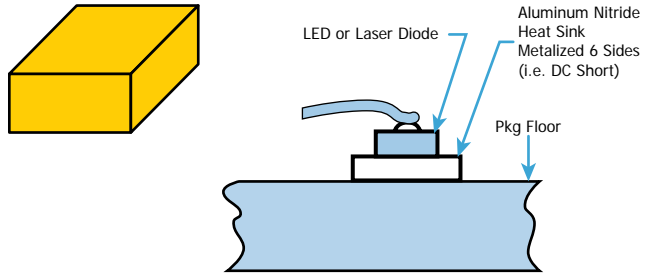

## Standoffs

- A Standoff is much like a Heatsink however it is typically metallized on only the top and bottom surfaces
- Each device is custom tailored to the customer's specifications and is typically used with LED's or Photo Diodes (works as a photo detector, light is allowed in through fibers)

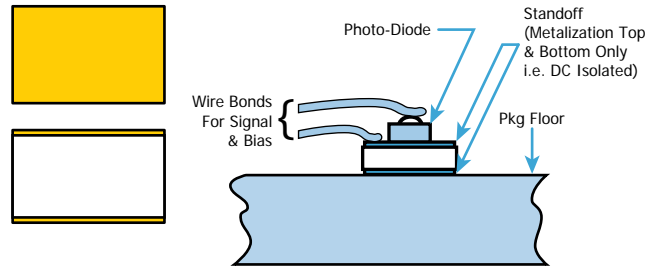

## Submounts

- Submounts are ceramic LED package bases which minimize thermal resistance between LED junctions and adjacent components
- By reducing junction temperatures, an LED will produce increased efficiency, brightness, color and reliability
- Each device is custom tailored to the customer's specifications

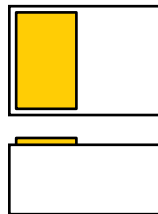

## Material Specifications

Material Code	Relative $\epsilon_r^*$ @ 5 GHz	TCC†Loss ppm/°C	Coefficient of Tangent* % Max	Thermal Thermal Expansion ppm/°K	Conductivity W/m-°K
AG	8.85 ± 0.35 (@ 1MHz)	Aluminum Nitride	0.10	4.6	140-180
PI	9.9 ± 0.15 (@ 1MHz)	Alumina 99.6%	0.01	6.5 - 7.5	27

\*Unless otherwise specified K dielectric measurement at approximately 5 GHz. †For the temperature range -55 to 125°C. \*\*Material only provided metallized.

## Surface Finish

Code	Roughness $R_a$	Material Process
X	>50 $\mu$ in.	As-Fired
Y	20 $\mu$ in.	Machined
Z	<5 $\mu$ in.	Polished
S	Special	Drawing required

## Metallization

Code	Description
M	300 Angstroms TiW, 100 $\mu$ in. min. Au
P	75 $\mu$ in. min. Nickel, 100 $\mu$ in. min. Au
E	Metallized and etched per Customer drawing
T	300 Angstroms min. TiW, 50 $\mu$ in. min. NiV, 300 $\mu$ in. min. Au-Sn
D	SPECIAL, DLI Design per Customer Requirements

# MLC - Dielectric Material & Case Sizes

AH	DLI Series	Case Size Footprint in. (mm)	Cap Value Range (pF)	Cap (pF)	Typical ESR			Series Resonance (MHz)	Working Voltage (Max)
					150 MHz	500 MHz	1 GHz		
					TCC (ppm/°C) (-55° to +125°C) Porcelain (P90) +90 ±20	C11AH	.055 x .055 (1.40 x 1.40)		
C17AH	.110 x .110 (2.79 x 2.79)	0.1 to 1000	1 10 1000	0.059 0.039 0.024	0.063 0.06 0.05	0.114 0.085 0.074	9064 3100 1290	1000	
C18AH	.110 x .110 (2.79 x 2.79)	0.1 to 1000	10 100 1000	0.059 0.028 0.023	0.094 0.069 0.063	0.138 0.109 -	3100 1290 400	1000	
C22AH	.220 x .250 (5.84 x 6.35)	1 to 2700	10 100 1000 2700	0.074 0.048 0.028 0.027	0.207 0.116 0.14 -	0.249 0.19 - -	2480 1000 320 214	2500	
C40AH	.380 x .380 (9.65 x 9.65)	1 to 5100	15 100 1000 5100	0.066 0.018 0.009 0.008	0.033 0.026 0.017 0.016	0.027 0.052 0.033 0.033	2100 680 210 95	7200	

CF	DLI Series	Case Size Footprint in. (mm)	Cap Value Range (pF)	Cap (pF)	Typical ESR			Series Resonance (MHz)	Working Voltage max
					150 MHz	500 MHz	1 GHz		
					TCC (ppm/°C) (-55° to +125°C) Porcelain (NPO) 0 ±15	C06CF	.063 x .030 (1.60 x 0.80)		
C11CF	.055 x .055 (1.40 x 1.40)	0.1 to 100	1 10 100	0.073 0.049 0.040	0.089 0.075 0.073	0.146 0.107 0.111	9900 3100 970	250	
C17CF	.110 x .110 (2.79 x 2.79)	0.1 to 1000	1 10 100 1000	0.073 0.065 0.041 0.034	0.082 0.098 0.070 0.073	0.124 0.136 0.102 -	9060 3100 1300 400	1000	
C18CF	.110 x .110 (2.79 x 2.79)	0.1 to 1000	1 10 1000	0.068 0.058 0.041	0.086 0.087 0.068	0.158 0.118 -	9060 3100 1000	1000	
C22CF	.220 x .250 (5.84 x 6.35)	1 to 2700	10 100 1000 2700	0.072 0.047 0.036 0.035	0.113 0.079 0.067 -	0.164 0.119 - -	2480 1000 320 214	2500	
C40CF	.380 x .380 (9.65 x 9.65)	1 to 5100	10 100 1000 5100	0.121 0.044 0.032 0.011	0.054 0.038 0.036 0.016	0.037 0.045 0.038 0.040	2100 680 210 95	7200	

NA	DLI Series	Case Size Footprint in. (mm)	Cap Value Range (pF)	Cap (pF)	Typical ESR			Series Resonance (MHz)	Working Voltage max
					150 MHz	500 MHz	1 GHz		
					TCC (ppm/°C) (-55° to +125°C) Ceramic (NPO) N30 ±15	C11NA	.055 x .055 (1.40 x 1.40)		
C17NA	.110 x .110 (2.79 x 2.79)	0.1 to 1000	1 10 100 1000	0.047 0.033 0.024 0.017	0.086 0.061 0.043 0.030	0.121 0.085 0.060 0.043	10360 3238 1012 316	1000	



# MLC - Dielectric Material & Case Sizes

UL	DLI Series	Case Size Footprint in. (mm)	Cap Value Range (pF)	Cap (pF)	Typical ESR			Series Resonance (MHz)	Working Voltage max
					150 MHz	500 MHz	1 GHz		
TCC (ppm/°C) (-55° to +125°C) Ceramic (NPO) 0 ±30	C04UL	.040 x .020 (1.0 x 0.5)	0.1 to 10	1	0.081	0.095	0.148	9820	200
				5	0.038	0.057	0.088	3930	
				10	0.036	0.058	0.087	2650	
	C06UL	.060 x .030 (1.60 x 0.80)	0.1 to 47	5	0.052	0.072	0.107	1750	250
				15	0.028	0.041	0.064	1010	
				47	0.023	0.043	0.070	570	
	C07UL	.110 x .070 (2.79 x 1.72)	0.1 to 100	5.6	0.053	0.086	0.129	5000	250
				10	0.029	0.041	0.066	3960	
				30	0.017	0.023	0.036	2540	
	C08UL	.080 x .050 (2.0 x 1.27)	0.1 to 100	100	0.051	0.078	0.126	6000	250
				9.5	0.041	0.060	0.094	4620	
				11	0.041	0.064	0.103	4340	
	C11UL	.055 x .055 (1.40 x 1.40)	0.1 to 100	100	0.066	0.084	0.125	7530	250
				10	0.037	0.057	0.086	3800	
				100	0.022	0.042	0.081	1430	
	C17UL	.110 x .110 (2.79 x 2.79)	0.1 to 1000	10	0.040	0.056	0.082	2940	1000
				100	0.021	0.035	0.057	910	
				470	0.016	0.029	-	420	

## DLI MLC Dielectric Materials

Dielectric Code	Temperature Coefficient -55°C to +125°C	Dissipation Factor @ 1 MHz (% Maximum)	Insulation Resistance (MΩ)	
			@ +25°C	@ +125°C
AH	P90 ± 20 ppm/°C	0.05	See Notes below	See Notes below
CF	0 ± 15 ppm/°C	0.05		
UL	0 ± 30 ppm/°C	0.05		
BL*	± 15%	2.50	>10 <sup>4</sup>	>10 <sup>3</sup>
NA	N30 ± 15 ppm/°C	0.05	>10 <sup>6</sup>	>10 <sup>5</sup>

\*Broadband Blocks only.

**Notes:** Insulation Resistance (Per MIL-PRF-55681 & MIL-PRF-55681/4)

High Frequency Capacitors (C11, C17 & C18)

@ +25°C: 10<sup>6</sup> MΩ (0.1pF to 470pF) / 10<sup>5</sup> MΩ (510pF to 1000pF)

@ +125°C: 10<sup>5</sup> MΩ (0.1pF to 470pF) / 10<sup>4</sup> MΩ (510pF to 1000pF)

All other Case sizes (C04, C06, C07, C08, C22, C40)

@ +25°C: 10<sup>5</sup> MΩ

@ +125°C: 10<sup>4</sup> MΩ

ESR and Resonance data is of typical performance and can vary from lot to lot. Consult factory for additional case size data.

## Temperature Coefficient of Capacitance

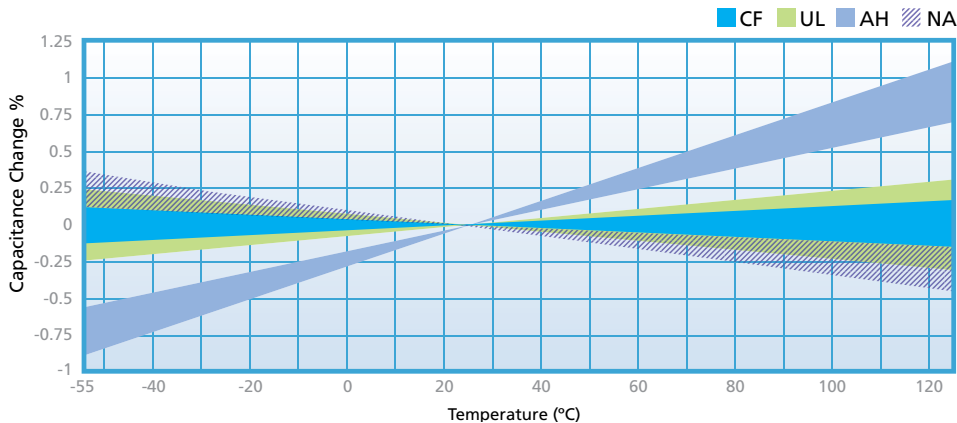

# MLC – Application Notes

## Chip Selection

Multilayer capacitors (MLC) are categorized by dielectric performance with temperature, or “temperature coefficient”, as these devices vary in behavior over temperature. The choice of component is thus largely determined by the temperature stability required of the device, i.e. type of dielectric, and the size necessary for a given capacitance and voltage rating. The following items are pertinent to chip selection:

### Dielectric Type

**CF:** Ultra stable Class I dielectric exceeds EIA COG requirements with negligible dependence of electrical properties on temperature, voltage, frequency and time, used in circuitry requiring very stable performance.

**AH:** EIA Class I dielectric with a dielectric constant that increases with temperature (90ppm/°C). Useful for temperature compensation where other board components may be losing capacitance with temperature.

**NA:** EIA Class I dielectric with a negative TCC. Useful in situations where other board components are gaining capacitance with temperature.

**UL:** EIA Stable Class I dielectric, with extremely low ESR. Useful in any application where heat generation or signal loss are concerns.

**BL:** EIA Stable Class II dielectric (X7R), with predictable change in properties with temperature, voltage, frequency and time. Used as blocking, de-coupling, bypassing and frequency discriminating elements. This dielectric is ferroelectric, and provides higher capacitance than Class I.

### Capacitor Size

Size selection is based primarily on capacitance value, voltage rating, and resonance frequency. Smaller units are generally less expensive; 0603 is the most economical size. Because mass affects the thermal shock behavior of chips, size selection must consider the soldering method used to attach the chip to the board. C18 and smaller can be wave, vapor phase or reflow soldered. Larger units require reflow soldering.

### Termination Material

Nickel barrier termination, with exceptional solder leach resistance is recommended for all applications involving solder. DLI offers two versions of the nickel barrier termination. The “Z” termination is a nickel barrier with 100% matte tin for a lead free capacitor. The “U” termination is a nickel barrier with 90/10 tin/lead for military applications. Non-magnetic versions of these termination finishes are also available.

### Solder Leaching

DLI’s termination finishes are designed to withstand RoHS attachment methods. During soldering, time above 230°C should be minimized to reduce thinning of the barrier layer and subsequent bond failure. DLI offers enhanced magnetic and non-magnetic termination finishes for applications requiring extended soldering time or repeated reflow cycles. Please consult your Sales Representative when ordering.

### Packaging

Units are available in bulk, reeled or in waffle pack.

## Attachment Methods

Bonding of capacitors to substrates can be categorized into two methods, those involving solder, which are prevalent, and those using other materials, such as epoxies and thermo-compression or ultrasonic bonding with wire. Please see DLI application note “Recommended Solder Attachment Techniques for MLC Chip and Pre-Thinned Capacitors” located on our website: [www.dilabs.com](http://www.dilabs.com).

### Soldering

Soldering methods commonly used in the industry and recommended are Reflow Soldering, Wave Soldering, and to a lesser extent, Vapor Phase Soldering. All these methods involve thermal cycling of the components and therefore the rate of heating and cooling must be controlled to preclude thermal shocking of the devices. In general, rates which do not exceed 120°C per minute and a temperature spike of 100°C maximum for any soldering process on sizes C18 and smaller is advisable. Other precautions include post soldering handling, primarily avoidance of rapid cooling with contact with heat sinks, such as conveyors or cleaning solutions.

Large chips are more prone to thermal shock as their greater bulk will result in sharper thermal gradients within the device during thermal cycling. Units larger than C18 experience excessive stress if processed through the fast cycles typical of solder wave or vapor phase operations. Solder reflow is most applicable to the larger chips as the rates of heating and cooling can be slowed within safe limits. In general, rates that do not exceed 60°C per minute and a temperature spike of 50°C maximum for any soldering process on sizes larger than C18 is advisable.

Attachment using a soldering iron requires extra care, particularly with large components, as thermal gradients are not easily controlled and may cause cracking of the chip. Precautions include preheating of the assembly to within 100°C of the solder flow temperature, the use of a fine tip iron which does not exceed 30 watts, and limitation of contact of the iron to the circuit pad areas only.

### Bonding

Hybrid assembly using conductive epoxy or wire bonding requires the use of silver palladium or gold terminations. Nickel barrier termination is not practical in these applications, as intermetallics will form between the dissimilar metals. The ESR will increase over time and may eventually break contact when exposed to temperature cycling.

### Cleaning

Chip capacitors can withstand common agents such as water, alcohol and degreaser solvents used for cleaning boards. Ascertain that no flux residues are left on the chip surfaces as these diminish electrical performance.

### DLI Shelf Life / Storage

Capacitors are solderable for a maximum of one year from the date of shipment if properly stored in the original packaging. Dry nitrogen storage is preferable for longer periods.

# MLC – Application Notes

## Board Design Considerations

The amount of solder applied to the chip capacitor will influence the reliability of the device. Excessive solder can create thermal and tensile stresses on the component which could lead to fracturing of the chip or the solder joint itself. Insufficient or uneven solder application can result in weak bonds, rotation of the device off line or lifting of one terminal off the pad (tombstoning). The volume of solder is process and board pad size dependent. WAVE SOLDERING exposes the devices to a large solder volume, hence the pad size area must be restricted to accept an amount of solder which is not detrimental to the chip size utilized. Typically the pad width is 66% of the component width, and the length is .030" (.762 mm) longer than the termination band on the chip. An 0805 chip which is .050" wide and has a .020" termination band therefore requires a pad .033" wide by .050" in length. Opposing pads should be identical in size to preclude uneven solder fillets and mismatched surface tension forces which can misalign the device. It is preferred that the pad layout results in alignment of the long axis of the chips at right angles to the solder wave, to promote even wetting of all terminals. Orientation of components in line with the board travel direction may require dual waves with solder turbulence to preclude cold solder joints on the trailing terminals of the devices, as these are blocked from full exposure to the solder by the body of the capacitor. Restrictions in chip alignment do not apply to SOLDER REFLOW or VAPOR PHASE processes, where the solder volume is controlled by the solder paste deposition on the circuit pads. There are practical limitations on capacitor sizes that prohibit reliable direct mounting of chip capacitors larger than 2225 to a substrate. Without mechanical restriction, thermally induced stresses are released once the capacitor attains a steady state condition, at any given temperature. Capacitors bonded to substrates, however, will retain some stress, due primarily to the mismatch of expansion of the component to the substrate; the residual stress on the chip is also influenced by the ductility and hence the ability of the bonding medium to relieve the stress. Unfortunately, the thermal expansions of chip capacitors differ significantly from those of substrate materials.

## Recommended Printed Wire Board Land Patterns

Printed Wire Board land pattern design for chip components is critical to ensure a reliable solder fillet, and to reduce nuisance type manufacturing problems such as component swimming and tombstoning. The land pattern suggested can be used for reflow and wave solder operations as noted. Land patterns constructed with these dimensions will yield optimized solder fillet formation and thus reduce the possibility of early failure.<sup>1</sup>

- A = (Max Length) + 0.030" (.762mm)\*
- B = (Max Width) + 0.010" (.254mm)\*\*
- C = (Min Length) – 2 (Nominal Band)\*\*\*

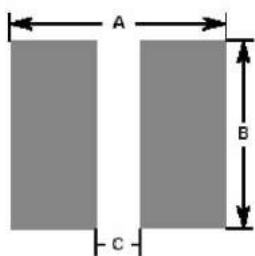

\* Add 0.030" for Wave Solder operations.  
\*\* Replace "Max Width" with "Max Thickness" for vertical mounting.  
\*\*\* "C" to be no less than 0.02"; change "A" to (Max Length) + 0.020".  
For CO4 "C" to be no less than 0.01".

1. Frances Classon, James Root, Martin Marietta Orlando Aerospace, "Electronics Packaging and Interconnection Handbook".

## Temperature Precautions

The rate of heating and cooling must be controlled to preclude thermal cracking of ceramic capacitors. Soldering temperatures should not exceed 200°C per minute, temperature variation must not exceed 100°C maximum for any solder operation. Avoid forced cooling or contact with heat sinks, such as conveyor belts, metal tables or cleaning solutions, before the chips reach ambient temperatures.

## MLC Orientation - Horizontal and Vertical Mounting

The orientation of the MLC relative to the ground plane affects the devices' impedance. When the internal electrodes are parallel to the ground plane (Horizontal mounting) the impedance of the MLC resembles a folded transmission line driven from one end. The below graph shows the modeled insertion loss and parallel resonances of C17AH101K-7UN-X0T with horizontal mounting. When the internal electrodes are perpendicular to the ground plane (Vertical mounting, bottom graph) the MLC impedance resembles a folded transmission line driven from the center reducing resonance effects. C11,17 are available with vertical or horizontal orientation in tape and reel packaging. Modeling can be done in CapCad. HP/EEs of series 4 contains models for C11 and C17 in the element libraries under Dielectric Laboratories MLC.

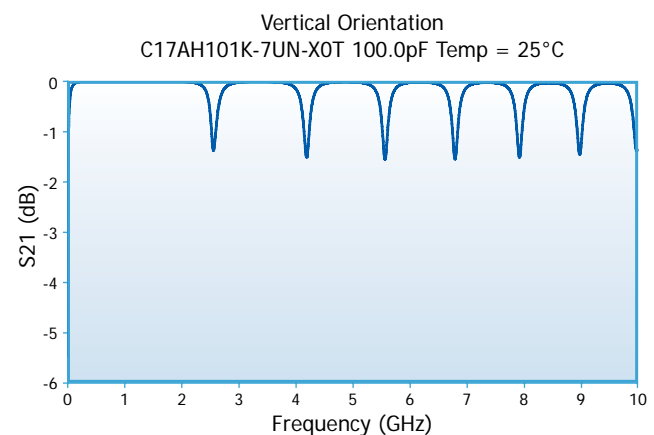
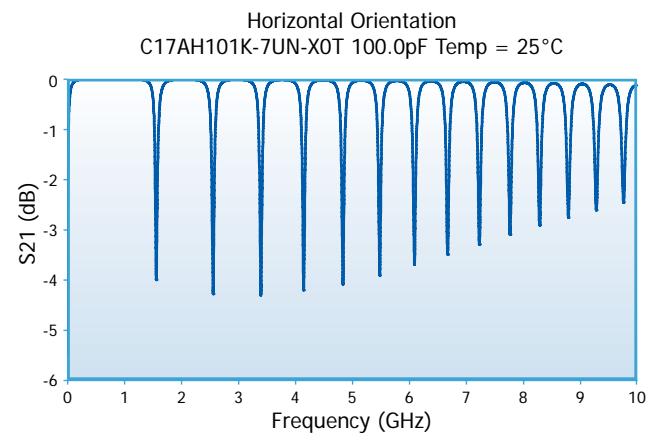

# MLC – General Information

## Case Size Definitions

Case Size	Case Code	Termination	Width				Length				Thickness <sup>(1)</sup> (Max)		Gap Min (Between Bands)		Band Min <sup>(2)</sup> (Plated)		Band Max <sup>(2)</sup> (Plated)	
			Inches		mm		Inches		mm		Inches	mm	Inches	mm	Inches	mm	Inches	mm
			Min.	Max.	Min.	Max.	Min.	Max.	Min.	Max.								
04BL	0402	U,S	.014	.026	.362	.667	.034	.049	.869	1.245	.025	.640	.008	.193	.004	.097	.017	.427
04UL	0402	S,Z	.014	.026	.362	.667	.034	.049	.869	1.245	.025	.640	.008	.193	.004	.097	.017	.427
06BL	0603	U,S,Z	.023	.038	.579	.960	.051	.069	1.303	1.760	.032	.800	.010	.241	.007	.169	.027	.680
06CF	0603	U,S,Z,E,P,W,H,V,R	.023	.038	.579	.960	.051	.069	1.303	1.760	.032	.800	.010	.241	.007	.169	.027	.680
06UL	0603	U,S,Z	.022	.041	.555	1.040	.051	.076	1.303	1.920	.033	.827	.014	.362	.007	.169	.027	.680
07UL	0711	S,Z	.090	.131	2.292	3.334	.052	.089	1.327	2.267	.105	2.667	.019	.483	.008	.193	.047	1.200
08BL	0805	U,S,Z	.040	.061	1.013	1.547	.065	.097	1.641	2.454	.054	1.360	.010	.241	.014	.362	.041	1.040
08UL	0805	U,S,Z	.040	.061	1.013	1.547	.065	.097	1.641	2.454	.054	1.360	.010	.241	.014	.362	.041	1.040
11	0505	U,S,Z,E,P,Q,Y,M,W,H,V,R	.038	.074	.965	1.867	.043	.074	1.086	1.867	.053	1.334	.014	.362	.008	.193	.029	.733
11	0505	T	.038	.074	.965	1.867	.043	.084	1.086	2.134	.053	1.334	.014	.362	NA	NA	NA	NA
17	1111	U,S,Z,E,P,Q,Y,M,W,H,V,R	.090	.131	2.292	3.334	.095	.137	2.413	3.467	.105	2.667	.038	.965	.008	.193	.047	1.200
17	1111	T	.090	.137	2.292	3.467	.095	.152	2.413	3.867	.105	2.667	.038	.965	NA	NA	NA	NA
18BL	1111	U,S,Z	.108	.133	2.743	3.378	.100	.120	2.540	3.048	.100	2.540	.040	1.016	.010	2.540	.040	1.016
18	1111	U,Z,E,W,H,V	.090	.142	2.292	3.600	.095	.152	2.413	3.867	.105	2.667	.043	1.086	.008	.193	.047	1.200
22	2222	U,S,Z,E,P,Q,Y,M,W,H,V,R	.223	.278	5.671	7.068	.200	.252	5.067	6.401	.137	3.467	.124	3.137	NA	NA	NA	NA
40	3838	U,S,Z,E,P,Q,Y,M,W,H,V,R	.352	.410	6.928	10.401	.352	.415	8.928	10.535	.137	3.467	.276	6.998	NA	NA	NA	NA

(1) Dimensions listed include the termination, not just ceramic.

(2) Band widths are from corner to corner of part.

\*C22-Bands must not have more than an .017 difference from the measured band on one end to the band on the other.

## Recommended Pad Spacing Dimensions (inches)

Case Size	Internal Electrode	Reflow Soldering			Wave Soldering		
		A	B	C	A	B	C
C04	Horizontal	0.076	0.036	0.010	0.106	0.036	0.020
	Vertical	Not Recommended			Not Recommended		
C06	Horizontal	0.106	0.051	0.020	0.136	0.051	0.020
	Vertical	Not Recommended			Not Recommended		
C07	Horizontal	0.119	0.141	0.020	0.149	0.141	0.020
	Vertical	Not Recommended			Not Recommended		
C08	Horizontal	0.127	0.071	0.020	0.157	0.071	0.020
	Vertical	0.127	0.064	0.020	0.157	0.064	0.020
C11	Horizontal	0.114	0.084	0.020	0.144	0.084	0.020
	Vertical	0.114	0.063	0.020	0.144	0.063	0.020
C17	Horizontal	0.182	0.147	0.040	0.212	0.147	0.040
	Vertical	0.182	0.115	0.040	0.212	0.115	0.040
C18	Horizontal	0.182	0.152	0.070	0.212	0.152	0.070
	Vertical	0.182	0.115	0.070	0.212	0.115	0.070
C22	Horizontal	0.282	0.288	0.110	0.312	0.288	0.110
	Vertical	Not Recommended			Not Recommended		
C40	Horizontal	0.445	0.420	0.290	0.475	0.420	0.290
	Vertical	Not Recommended			Not Recommended		



# MLC - General Information

## Termination Systems

Code	Termination System	Application
T	Ag Termination Ni Barrier Layer Heavy SnPb Plated Solder	<ul style="list-style-type: none"> <li>High Reliability Applications</li> <li>Hand Soldering</li> </ul>
U	Ag Termination Ni Barrier Layer SnPb Plated Solder	<ul style="list-style-type: none"> <li>High Reliability Applications</li> <li>High Volume &amp; Hand Solder Assembly</li> </ul>
S RoHS	Ag Termination Ni Barrier Layer Gold Flash	<ul style="list-style-type: none"> <li>Specialty Solder, Epoxy Applications</li> <li>Standard for 0402</li> </ul>
Z RoHS	Ag Termination Ni Barrier Layer Sn Plated Solder	<ul style="list-style-type: none"> <li>High Volume &amp; Hand Solder Assembly</li> </ul>
E RoHS	Ag Termination Enhanced Ni Barrier Sn Plated Solder	<ul style="list-style-type: none"> <li>High Volume &amp; Hand Solder Assembly</li> <li>Ultra Leach Resistant</li> </ul>
P RoHS	AgPd Termination	<ul style="list-style-type: none"> <li>Non-Magnetic Applications</li> </ul>
Q RoHS	Polymer Termination Ni Barrier Layer Sn Plated Solder	<ul style="list-style-type: none"> <li>Resistant to Cracking</li> <li>High Volume &amp; Hand Solder Assembly</li> </ul>

Code	Termination System	Application
Y	Polymer Termination Ni Barrier Layer Sn/Pb Plated Solder	<ul style="list-style-type: none"> <li>Resistant to Cracking</li> <li>High Reliability Applications</li> <li>High Volume &amp; Hand Solder Assembly</li> </ul>
M RoHS	Polymer Termination Cu Barrier Layer Sn Plated Solder	<ul style="list-style-type: none"> <li>Resistant to Cracking</li> <li>Non-Magnetic Application</li> <li>High Volume &amp; Hand Solder Assembly</li> </ul>
W RoHS	Ag Termination Cu Barrier Layer Sn Plated Solder	<ul style="list-style-type: none"> <li>Non-Magnetic Application</li> <li>High Volume</li> </ul>
H RoHS	Ag Termination Enhanced Cu Barrier Sn Plated Solder	<ul style="list-style-type: none"> <li>Non-Magnetic Applications</li> <li>High Vol. &amp; Hand Solder Assembly</li> <li>Ultra Leach Resistant</li> </ul>
V	Ag Termination Cu Barrier Layer SnPb Plated Solder	<ul style="list-style-type: none"> <li>Non-Magnetic Applications</li> <li>High Reliability Applications</li> <li>High Volume &amp; Hand Solder Assembly</li> </ul>
R	Ag Termination Cu Barrier Layer Heavy SnPb Plated Solder	<ul style="list-style-type: none"> <li>Non-Magnetic Applications</li> <li>High Reliability Applications</li> <li>Hand Soldering</li> </ul>

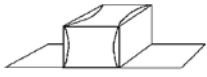
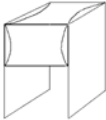
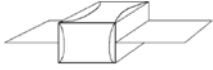
**Lead Termination Codes** Leads are attached with high melting point solder (HMP) at 296°C.

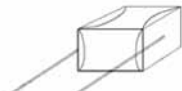
Axial Ribbon Code A	Radial Ribbon Code B	Center Ribbon Code C	Axial Wire Lead Code E	Radial Wire Lead Code F
				

## Packaging Configurations

Case Style	Size L x W	7" Reel, 8mm Tape		7" Reel, 16mm Tape	13" Reel, 16mm Tape	2" x 2" Waffle Pack
		Horizontal Orientation	Vertical Orientation	Horizontal Orientation	Horizontal Orientation	
C04	0.040" x 0.020"	5000				
C06	0.060" x 0.030"	4000				108
C07	0.110" x 0.070"	2000				
C08	0.080" x 0.050"	5000	3100			108
C11	0.055" x 0.055"	3500	3100			108
C17	0.110" x 0.110"	2350	750			49
C18	0.110" x 0.110"	2350	750			49
C22	0.220" x 0.245"	500				
C40	0.380" x 0.380"	250		250	1300	

## Test Level Codes

Test code	Inspection Description - see individual part pages for additional detail
Y	100% IR, 1% AQL visual, 1% AQL Electrical (DWV, Cap., DF)
X	100% IR, 1 % visual, 1% AQL Electrical (DWV, Cap., DF)
A	Group A testing per MIL – PRF – 55681
C	Group C testing per MIL – PRF – 55681
D	Customer Defined

Typically a minimum 500 piece order for tape and reel packaging.

Standard Packaging: Bulk in plastic bags.

Consult factory for custom packaging solutions.

# MLC - Standard P/N System

<b>C</b>	<b>17</b>	<b>CF</b>	<b>620</b>	<b>J-</b>	<b>7</b>	<b>U</b>	<b>N-</b>	<b>X</b>	<b>0</b>	<b>T</b>
MLC Capacitor	Case Size	Material System	Capacitance Code	Tolerance Level	Voltage Code	Termination Code	Leading Code	Test Level	Marking Code	Packaging

## Case Size **17**

Case	Dimensions
04	0.040" x 0.020"
06	0.060" x 0.030"
07	0.110" x 0.070"
08	0.080" x 0.050"
11	0.055" x 0.055"
17	0.110" x 0.110"
18	0.110" x 0.110"
22	0.220" x 0.250"
40	0.380" x 0.380"

## Material **CF**

Material	Characteristics
AH	P90 High-Q
CF	NPO High-Q
UL	Ultra Low ESR-NPO
BL	DC Blocking Ultra
NA	N30 High-Q

## Capacitance **620**

First two digits	Significant figures in capacitance
Third digit	Additional number of zeros
R	Represents a decimal point
Examples:	620 = 62pF 152 = 1500pF

## Tolerance **J**

Code	Value
A	± 0.05pF
B	± 0.1pF
C	± 0.25pF
D	± 0.5pF
F	± 1%
G	± 2%
J	± 5%
K	± 10%
M	± 20%
X	GMV
S	SPECIAL

<10pF A, B, C, D  
>10pF F, G, J, K, M

## Voltage **7**

Code	Value
5	50V
1	100V
8	150V
6	200V
9	250V
3	300V
4	500V
7	1000V
A	1500V
G	2000V
B	2500V
D	3600V
F	5000V
H	7200V
S	SPECIAL

## Termination

Code	Termination System
T	Ag Termination, Ni Barrier Layer, Heavy SnPb Plated Solder
U	Ag Termination, Ni Barrier Layer, SnPb Plated Solder
S	Ag Termination, Ni Barrier Layer, Gold Flash
Z	Ag Termination, Ni Barrier Layer, Sn Plated Solder
E	Ag Termination, Enhanced Ni Barrier, Sn Plated Solder
P**	AgPd Termination
Q	Polymer Termination, Ni Barrier Layer, Sn Plated Solder
Y	Polymer Termination, Ni Barrier Layer, SnPb Plated Solder
M**	Polymer Termination, Cu Barrier Layer, Sn Plated Solder
W**	Ag Termination, Cu Barrier Layer, Sn Plated Solder
H**	Ag Termination, Enhanced Cu Barrier, Sn Plated Solder
V**	Ag Termination, Cu Barrier Layer, SnPb Plated Solder
R**	Ag Termination, Cu Barrier Layer, Heavy SnPb Plated Solder

**NOTE:** All fields are required. Any specials, please consult factory.  
\*\* Nonmagnetic

## Leading **N**

Code	Lead Type
A	Axial Ribbon
B	Radial Ribbon
C	Center Ribbon
D	Specialty Customer Defined
E	Axial Wire
F	Radial Wire
N	NONE

**NOTE:** Consult Sales Representative for RoHS compliant leaded devices

## Test Level **X**

Code	Testing
X	Commercial or Industrial
Y	Reduced Visual
A	MIL-PRF-55681 Group A
C	MIL-PRF-55681 Group C
D	Customer Specified

## Laser Mark **0**

Code	Laser Marking
0	No marking
1*	Single-side marked
2*	Double-side marked
3*	Large single-side marked
4*	Large double-side marked
5*	Vertical edge marked
9	Customer Specified

\*Reduces DWV Rating.

## Packaging **T**

Code	Packaging
T	Tape & Reel – Horizontal
V	Tape & Reel – Vertical
W	Waffle Pack
B	Bulk
P	Plastic Box
R	Tube (Rail)
S	Customer Specified

# MLC - AH Series: P90 Porcelain Capacitors



## Description

- High Q Porcelain Capacitors • SMD Compatibility
- Positive TC "P90" • Low ESR, High Q
- Capacitance range 0.1 - 5100 pF
- Operating Range -55° to +125°C • High Voltage
- High Self-resonance • Low Noise • Established Reliability

## Functional Applications

- Impedance Matching • Power Handling • DC Blocking
- Bypass • Coupling • Tuning and Feedback
- Amplifier Matching Networks • VCO Frequency Stabilization
- Filtering, Diplexers and Antenna Matching
- High RF Power Circuits • Oscillators • Timing Circuits
- Filters • RF Power Amplifiers and Delay Lines

## Dielectric characteristics

Dielectric Material (Code)	P90 (AH)	
Temperature Coefficient (ppm/°C )	+90 ± 20	
Dissipation Factor (% @ 1MHz Maximum)	0.05	
Dielectric Withstanding Voltage	Voltage Rating (Volts)	Refer to table
	DWV (Volts)	250% of rated
Insulation Resistance (MΩ Minimum)	@ +25°C	10 <sup>6</sup> MΩ min
	@ +125°C	10 <sup>5</sup> MΩ min
Ageing	None	
Piezoelectric Effects	None	
Dielectric Absorption	None	

Note: Refer to table on page 28 for ordering information.

## Capacitance and Voltage Table

Cap Code	Cap (PF)	C11 0505	C17 1111	Case Size C18 1111	C22 2225	C40 3838
0R1	0.1					
0R2	0.2					
0R3	0.3					
0R4	0.4					
0R5	0.5					
0R6	0.6					
0R7	0.7					
0R8	0.8					
0R9	0.9					
1R0	1.0					
1R1	1.1					
1R3	1.3					
1R4	1.4					
1R5	1.5					
1R6	1.6					
1R7	1.7					
1R8	1.8					
1R9	1.9					
2R0	2.0					
2R1	2.1					
2R2	2.2					
2R4	2.4					
2R7	2.7					
3R0	3.0					
3R3	3.3					
3R6	3.6					
3R9	3.9					
4R3	4.3					
4R7	4.7					
5R1	5.1					
5R6	5.6					
6R2	6.2					
6R8	6.8					
7R5	7.5					
8R2	8.2					
9R1	9.1					
100	10					
110	11					
120	12					
130	13					
150	15					
160	16					
180	18					
200	20					
220	22					
240	24					
270	27					
300	30					
330	33					
360	36					
390	39					
430	43					
470	47					
510	51					
560	56					
620	62					
680	68					
750	75					
820	82					
910	91					
101	100					
111	110					
121	120					
131	130					
151	150					
161	160					
181	180					
201	200					
221	220					
241	240					
271	270					
301	300					
331	330					
361	360					
391	390					
431	430					
471	470					
511	510					
561	560					
621	620					
681	680					
751	750					
821	820					
911	910					
102	1000					
122	1200					
152	1500					
182	1800					
222	2200					
272	2700					
332	3300					
392	3900					
472	4700					
512	5100					
Reel QTY		3500	2350	2350	500	250
Horizontal						

Special capacitance values available upon request.

# MLC - AH Series: P90 Porcelain Capacitors

**ESR vs Frequency  
DLI C11 AH Series**

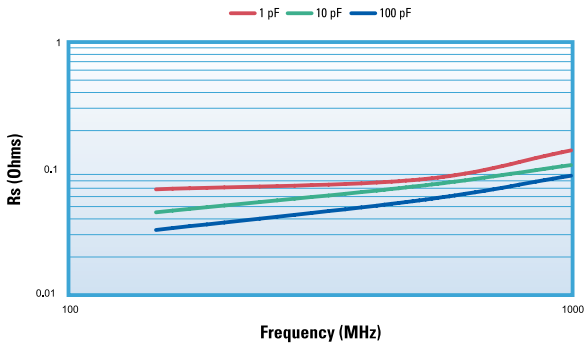

**Q vs Capacitance  
DLI C11 AH Series**

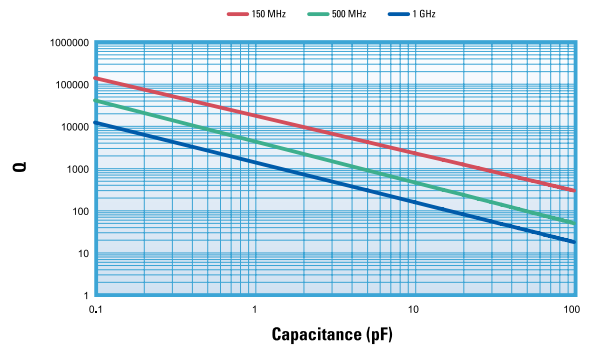

**ESR vs Frequency DLI C17 AH Series**

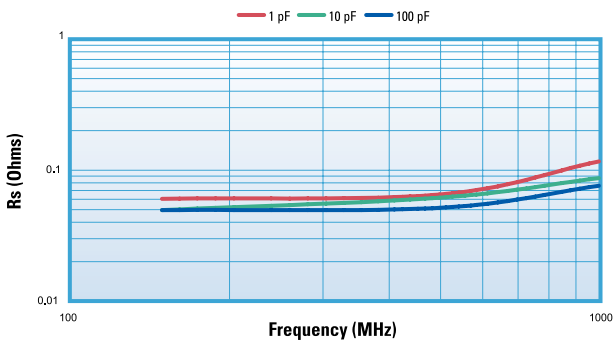

**Q vs Capacitance DLI C17 AH Series**

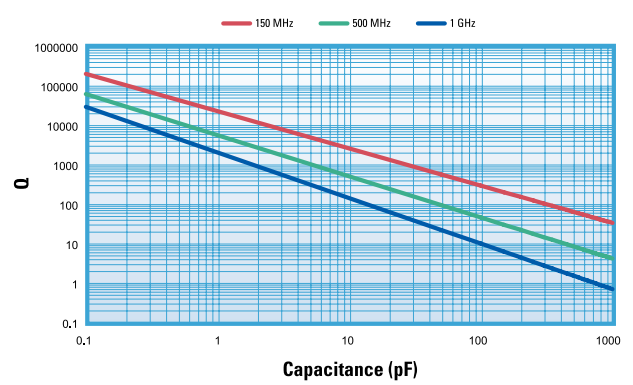

**ESR vs Frequency  
DLI C18 AH Series**

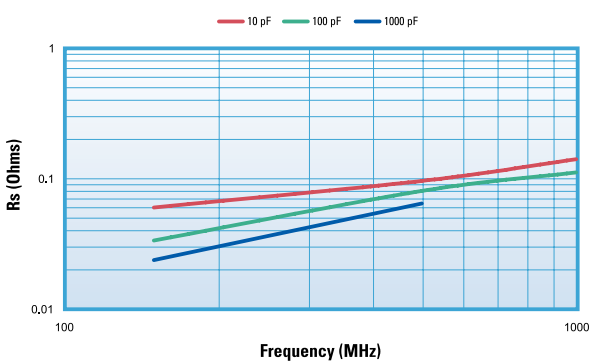

**Q vs Capacitance  
DLI C18 AH Series**

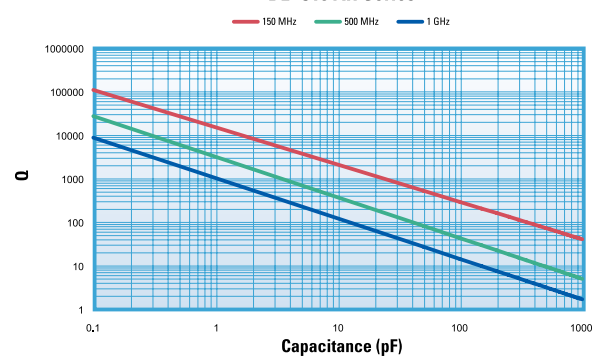

**ESR vs Frequency  
DLI C22 AH Series**

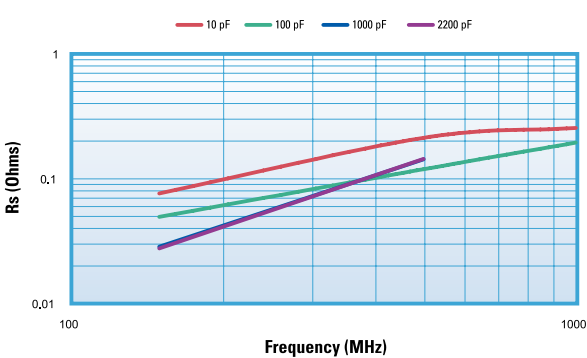

**Q vs Capacitance  
DLI C22 AH Series**

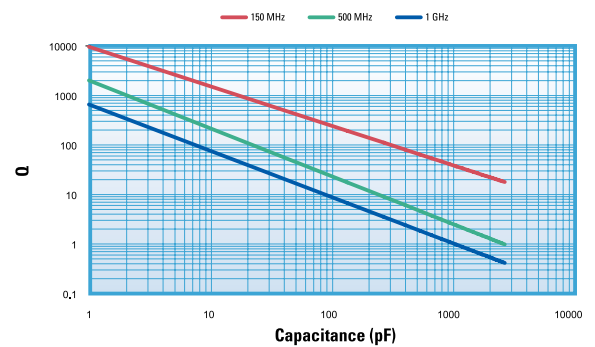

This information represents typical device performance.



# MLC - AH Series: P90 Porcelain Capacitors

**ESR vs Frequency**  
DLI C40 AH Series

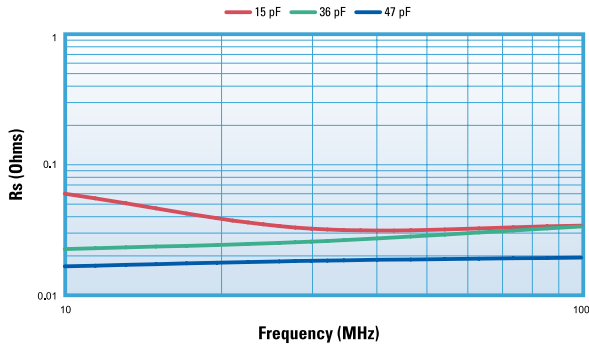

**Q vs Capacitance**  
DLI C40 AH Series

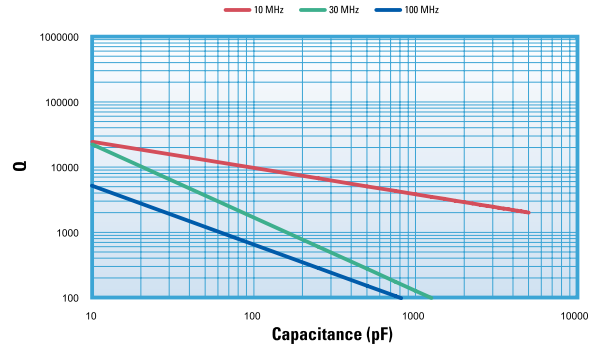

**Resonant Frequency vs Capacitance**  
DLI C11 AH Series

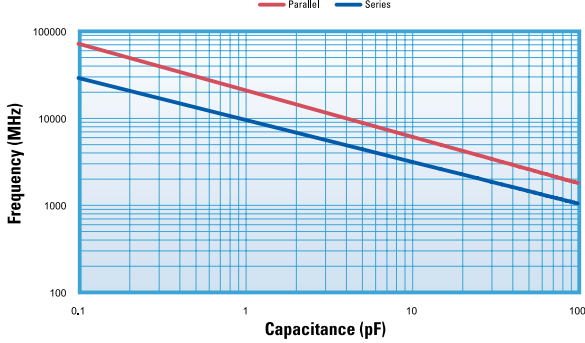

**First Resonance Frequency vs Capacitance**  
DLI C17AH Series

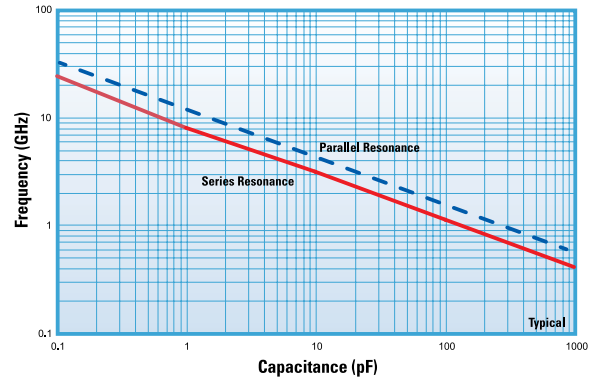

**Current Rating vs. Capacitance,**  
(infinite heat sink, 25°C ambient temperature)  
DLI C17AH Series

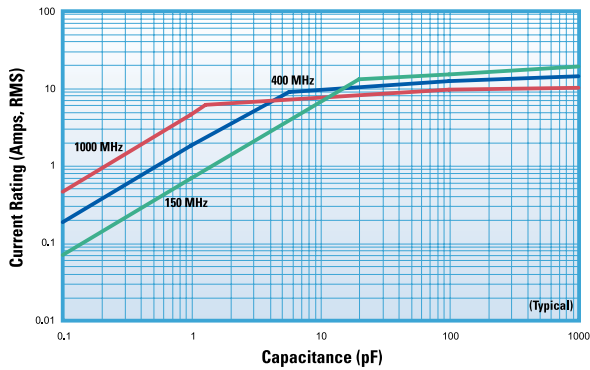

This information represents typical device performance.

**Part Number** See Page 28 for complete part number system.

<b>C</b>	<b>17</b>	<b>AH</b>	<b>620</b>	<b>J-</b>	<b>7</b>	<b>U</b>	<b>A-</b>	<b>X</b>	<b>0</b>	<b>T</b>
MLC Capacitor	Case Size	Material System	Capacitance Code	Tolerance Level	Voltage Code	Termination Code	Leading Code	Test Level	Marking Code	Packaging

Terminations	Lead Types*	Test Level - All Case Sizes	Laser Marking	Packaging
C11 T, U, S, Z, E, P, Q, Y, M, W, H, V, R	C11 A, B, D	X Standard	C11 0, 1, 2, 5	C11 T, V, W, B, P, S
C17 T, U, S, Z, E, P, Q, Y, M, W, H, V, R	C17 A, B, C, D, E, F	Y Reduced Visual	C17 0, 1, 2, 3, 4, 5	C17 T, V, W, B, P, S
C18 U, Z, E, Y, W, H	C18 A, B, C, D, E, F	A MIL-PRF-55681 Group A	C18 0, 1, 2, 5	C18 T, V, W, B, P, S
C22 U, S, Z, E, P, Q, Y, M, W, H, V, R	C22 A, B, C, D, E, F	C MIL-PRF-55681 Group C	C22 0, 1	C22 T, B, P, S
C40 T, U, S, Z, E, P, Q, Y, M, W, H, V, R	C40 A, B, C, D, E, F	D Customer Specified	C40 0, 1	C40 T, B, P, S, R

\*Special leading requirements available.

# MLC - CF Series - Ultrastable Porcelain Capacitors

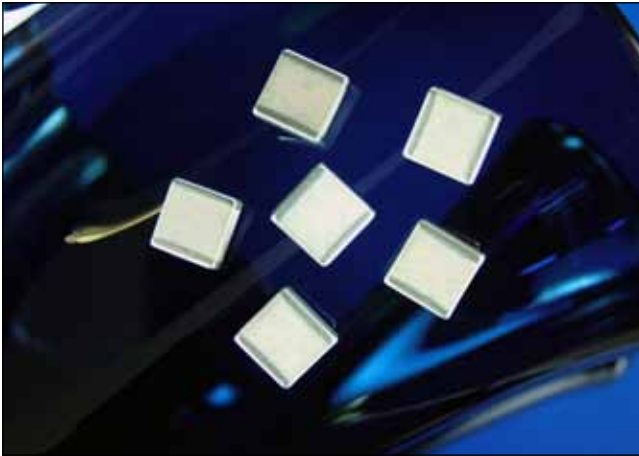

## Description

- High Q Porcelain Capacitors • SMD Compatibility
- Ultra Temperature Stable • Low ESR, High Q
- Capacitance range 0.1 - 5100 pF
- Operating Range -55° to +125°C • High Voltage
- High Self-resonance • Low Noise • Established Reliability

## Functional Applications

- Impedance Matching • Power Handling • DC Blocking
- Bypass • Coupling • Tuning and Feedback
- Amplifier Matching Networks • VCO Frequency Stabilization
- Filtering, Diplexers and Antenna Matching
- High RF Power Circuits • Oscillators • Timing Circuits
- Filters • RF Power Amplifiers and Delay Lines

## Dielectric characteristics

Dielectric Material (Code)	COG/NP0 (CF)	
Temperature Coefficient (ppm/°C)	0 ± 15	
Dissipation Factor (% @ 1MHz Maximum)	0.05	
Dielectric Withstanding Voltage	Voltage Rating (Volts)	Refer to table
	DWV (Volts)	250% of rated
Insulation Resistance (MΩ Minimum)	@ +25°C	10 <sup>6</sup> MΩ min
	@ +125°C	10 <sup>5</sup> MΩ min
Ageing	None	
Piezoelectric Effects	None	
Dielectric Absorption	None	

Note: Refer to table on page 28 for ordering information.

## Capacitance and Voltage Table

Cap Code	Cap (PF)	Case Size					
		C06 0603	C11 0505	C17 1111	C18 1111	C22 2225	C40 3838
0R1	0.1						
0R2	0.2						
0R3	0.3						
0R4	0.4						
0R5	0.5						
0R6	0.6						
0R7	0.7						
0R8	0.8						
0R9	0.9						
1R0	1.0						
1R1	1.1						
1R3	1.3						
1R4	1.4						
1R5	1.5						
1R6	1.6						
1R7	1.7						
1R8	1.8						
1R9	1.9						
2R0	2.0						
2R1	2.1						
2R2	2.2						
2R4	2.4						
2R7	2.7						
3R0	3.0						
3R3	3.3						
3R6	3.6						
3R9	3.9						
4R3	4.3						
4R7	4.7						
5R1	5.1						
5R6	5.6						
6R2	6.2						
6R8	6.8						
7R5	7.5						
8R2	8.2						
9R1	9.1						
100	10						
110	11						
120	12						
130	13						
150	15						
160	16						
180	18						
200	20						
220	22						
240	24						
270	27						
300	30						
330	33						
360	36						
390	39						
430	43						
470	47						
510	51						
560	56						
620	62						
680	68						
750	75						
820	82						
910	91						
101	100						
111	110						
121	120						
131	130						
151	150						
161	160						
181	180						
201	200						
221	220						
241	240						
271	270						
301	300						
331	330						
361	360						
391	390						
431	430						
471	470						
511	510						
561	560						
621	620						
681	680						
751	750						
821	820						
911	910						
102	1000						
122	1200						
152	1500						
182	1800						
222	2200						
272	2700						
332	3300						
392	3900						
472	4700						
512	5100						
Reel QTY		4000	3500	2350	2350	500	250

Special capacitance values available upon request.

# MLC - CF Series - Ultrastable Porcelain Capacitors

**ESR vs Frequency  
DLI C06 CF Series**

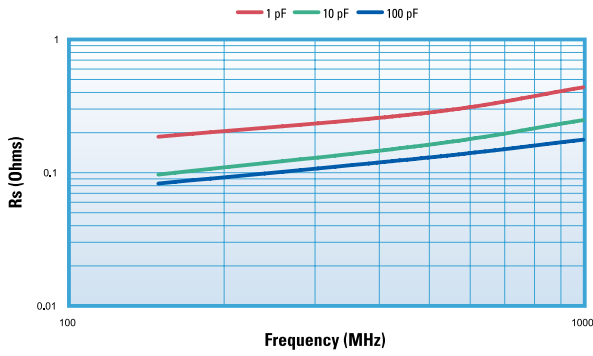

**Q vs Capacitance  
DLI C06 CF Series**

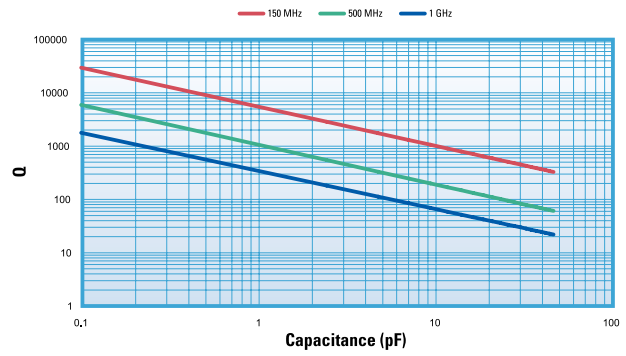

**ESR vs Frequency  
DLI C11 CF Series**

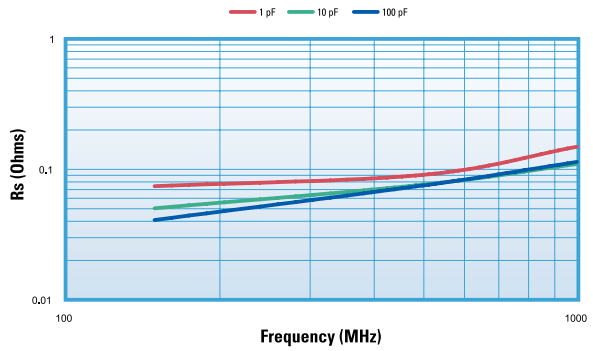

**Q vs Capacitance  
DLI C11 CF Series**

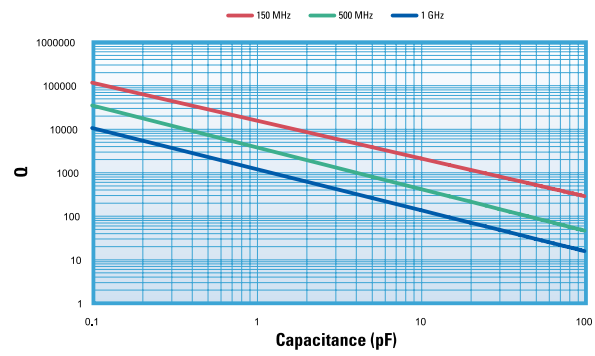

**ESR vs Frequency  
DLI C17 CF Series**

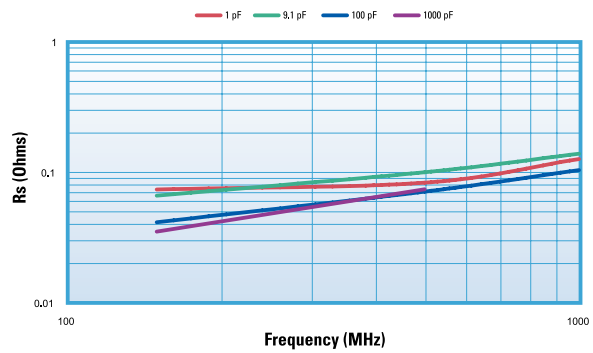

**Q vs Capacitance  
DLI C17 CF Series**

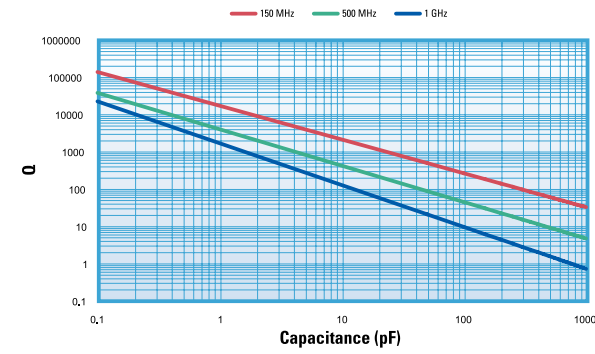

**ESR vs Frequency  
DLI C18 CF Series**

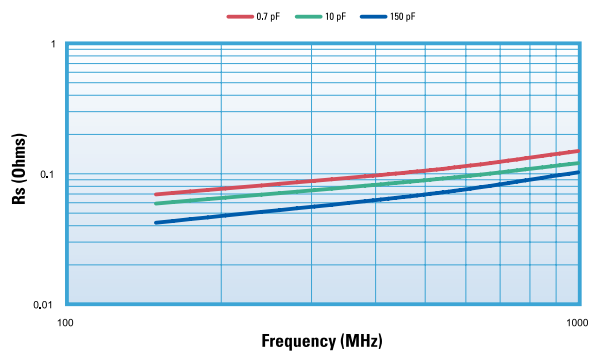

**Q vs Capacitance  
DLI C18 CF Series**

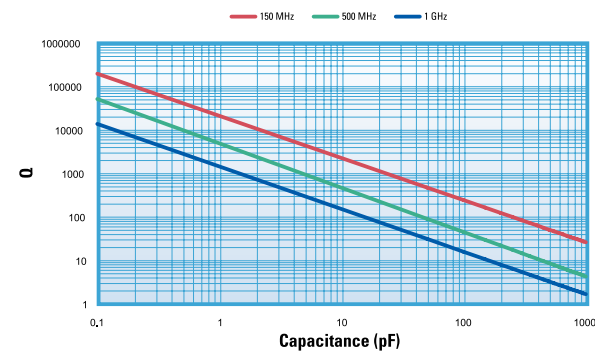

The information above represents typical device performance.

# MLC - CF Series: Ultrastable Porcelain Capacitors

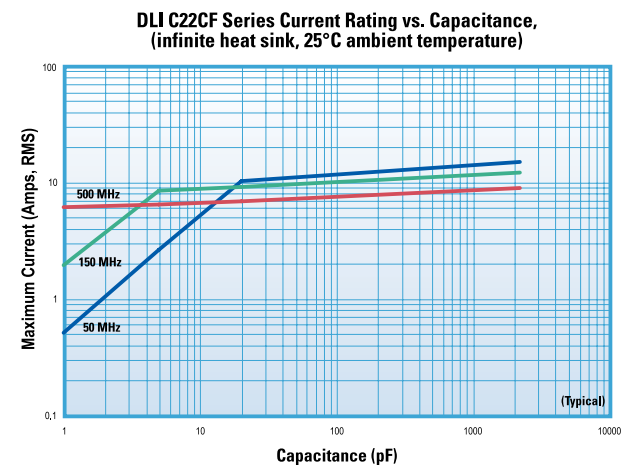
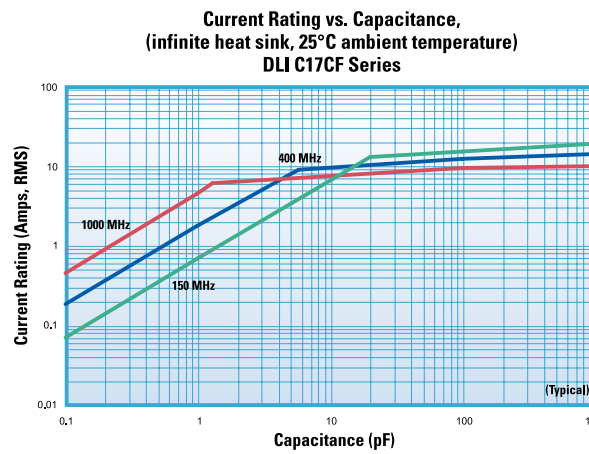
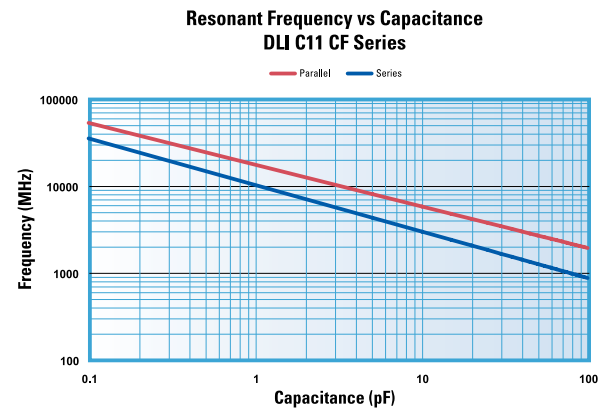
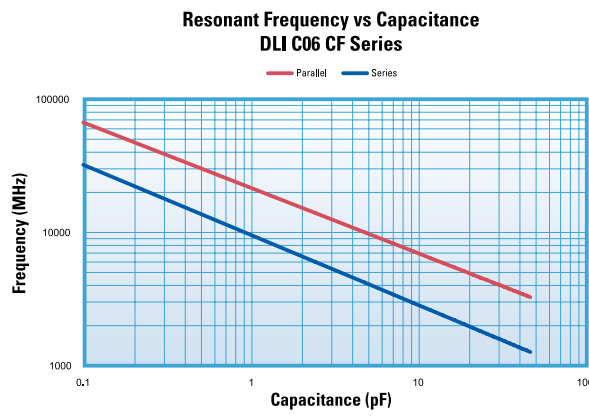
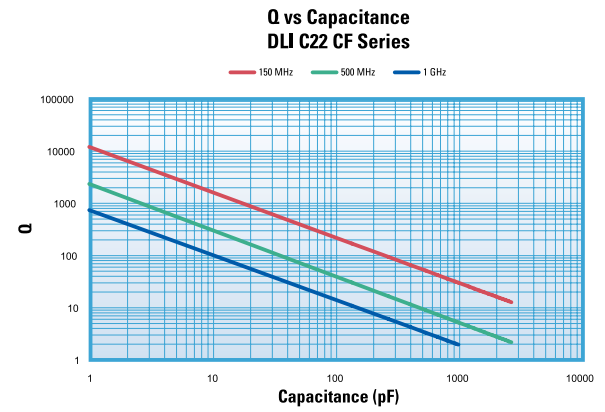
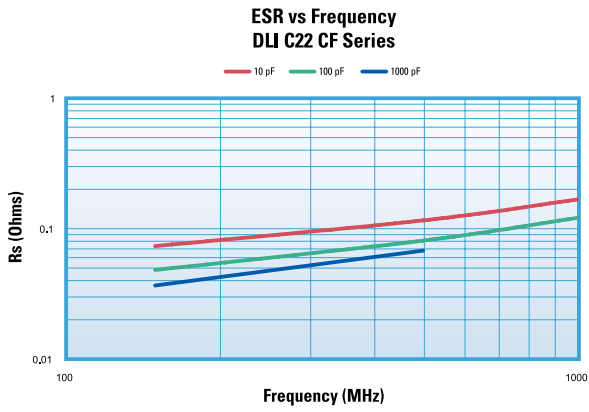

This information represents typical device performance.

**Part Number** See Page 28 for complete part number system.

<b>C</b>	<b>17</b>	<b>CF</b>	<b>620</b>	<b>J-</b>	<b>7</b>	<b>U</b>	<b>N-</b>	<b>X</b>	<b>0</b>	<b>T</b>
MLC Capacitor	Case Size	Material System	Capacitance Code	Tolerance Level	Voltage Code	Termination Code	Leading Code	Test Level	Marking Code	Packaging

Terminations		Lead Types		Test Level - All Case Sizes		Laser Marking		Packaging	
C06	U, S, Z, E, P, Q, Y, W, H, V, R	C11	A, B, D	X	Standard	C06	0, 1, 2, 5	C06	T, W, B, S
C11/17	T, U, S, Z, E, P, Q, Y, W, H, V, R	C17	A, B, C, D, E, F	Y	Reduced Visual	C11	0	C11/17	T, V, W, B, P, S
C18	U, Q, Y, V, W, H, Z	C18	A, B, C, D, E, F	A	MIL-PRF-55681 Group A	C17	0, 1, 2, 5	C18	T, V, W, B, P, S
C22	U, S, Z, E, P, Q, Y, W, H, V, R	C22	A, B, C, D, E, F	C	MIL-PRF-55681 Group C	C18	0, 1	C22	T, B, P, S
C40	T, U, S, P, Q, Y, W, H, V, R	C40	A, B, C, D, E, F	D	Customer Specified	C22/40	0, 1	C40	T, B, P, S, R

\*Special leading requirements available.

# MLC - NA Series: N30 Porcelain Capacitors



## Description

- Porcelain Capacitors • SMD Compatibility
- N30  $\pm 15$  ppm/ $^{\circ}\text{C}$  • Low ESR, High Q
- Capacitance Range 0.1 - 1000 pF
- Operating Range  $-55^{\circ}$  to  $+125^{\circ}\text{C}$  • High Voltage
- High Self-resonance • Low Noise • Established Reliability

## Functional Applications

- Impedance Matching • DC Blocking • Bypass • Coupling
- Tuning & Feedback • Amplifier Matching Networks
- VCO Frequency Stabilization
- Filtering, Diplexers & Antenna Matching
- High RF Power Circuits • Oscillators • Timing Circuits
- Filters • RF Power Amplifiers & Delay Lines
- Power Handling

## Dielectric Characteristics

Dielectric Material Code	NA	
Temperature Coefficient (ppm/ $^{\circ}\text{C}$ )	$-30 \pm 15$	
Dissipation Factor (% @ 1MHz Maximum)	0.05	
Dielectric Withstanding Voltage	Voltage Rating (Volts)	See Page 28
	DWV (Volts)	250% of WVDC for 5 sec unless specified in table
Insulation Resistance (M $\Omega$ Minimum)	@ $+25^{\circ}\text{C}$	$10^6$
	@ $+125^{\circ}\text{C}$	$10^5$
Aging	None	
Piezoelectric Effects	None	
Dielectric Absorption	None	

**Part Number** See Page 52 for complete part number system.

### Terminations

C04	S
C06/07/08/11/17	U, S, Z

### Lead Types

C04/06/07/08	N
C11	A, B, D
C17	A, B, C, D, E, F

### Packaging

C04/06	T, W, B, P, S
C07	W, B, P, S
C08/11/17	T, V, W, B, P, S

### Laser Marking

C04	0
C06	0, 1, 2
C07	0, 1,
C08/11/17	0, 1, 2

### Test Level - All Case Sizes

X	Standard
Y	Reduced Visual
A	MIL-PRF-55681 Group A
C	MIL-PRF-55681 Group C
D	Customer Specified

## Capacitance and Voltage Table

Cap Code	Cap (PF)	Case Size	
		C11 0505	C17 1111
OR1	0.1		
OR2	0.2		
OR3	0.3		
OR4	0.4		
OR5	0.5		
OR6	0.6		
OR7	0.7		
OR8	0.8		
OR9	0.9		
1R0	1.0		
1R1	1.1		
1R3	1.3		
1R4	1.4		
1R5	1.5		
1R6	1.6		
1R7	1.7		
1R8	1.8		
1R9	1.9		
2R0	2.0		
2R1	2.1		
2R2	2.2		
2R4	2.4		
2R7	2.7		
3R0	3.0		
3R3	3.3		
3R6	3.6		
3R9	3.9		
4R3	4.3		
4R7	4.7		
5R1	5.1		
5R6	5.6		
6R2	6.2		
6R8	6.8		
7R5	7.5		
8R2	8.2		
9R1	9.1		
100	10		
110	11		
120	12		
130	13		
150	15		
160	16		
180	18		
200	20		
220	22		
240	24		
270	27		
300	30		
330	33		
360	36		
390	39		
430	43		
470	47		
510	51		
560	56		
620	62		
680	68		
750	75		
820	82		
910	91		
101	100		
111	110		
121	120		
131	130		
151	150		
161	160		
181	180		
201	200		
221	220		
241	240		
271	270		
301	300		
331	330		
361	360		
391	390		
431	430		
471	470		
511	510		
561	560		
621	620		
681	680		
751	750		
821	820		
911	910		
102	1000		
122	1200		
152	1500		
182	1800		
222	2200		
272	2700		
332	3300		
392	3900		
472	4700		
512	5100		
Reel QTY		3500	2350
Horizontal			

Special capacitance values available upon request.

# MLC - UL Series: Ultra Low ESR Ceramic Capacitors



## Description

- Ceramic Capacitors • SMD Compatibility • Stable TC NP0
- Low ESR, High Q • Capacitance range 0.2 - 2200 pF
- Operating Range -55° to +125°C • High Voltage
- Low Noise • EIA 0603 & 0805 Case Size

## Functional Applications

- DC Blocking • Bypass • Coupling • Tuning & Feedback
- Amplifier Matching Networks • VCO Frequency Stabilization
- Filtering, Diplexers & Antenna Matching
- High RF Power Circuits • Oscillators • Timing Circuits
- Filters • Broadcast Power Amps
- RF Power Amplifiers & Delay Lines

## Dielectric Characteristics

Dielectric Material Code	UL	
Temperature Coefficient (ppm/°C )	0 ± 30	
Dissipation Factor (% @ 1MHz Maximum)	0.05	
Dielectric Withstanding Voltage	Voltage Rating (Volts)	Refer to table
	DWV (Volts)	250% of rated
Insulation Resistance (MΩ Minimum)	@ +25°C	**
	@ +125°C	**
Aging	None	
Piezoelectric Effects	None	
Dielectric Absorption	None	

\*\* Refer to table and statement provided on Page 28.

## Capacitance and Voltage Table

Cap Code	Cap (PF)	Case Size					
		C04 0402	C06 0603	C07 0711	C08 0805	C11 0505	C17 1111
0R1	0.1						
0R2	0.2						
0R3	0.3						
0R4	0.4						
0R5	0.5						
0R6	0.6						
0R7	0.7						
0R8	0.8						
0R9	0.9						
1R0	1.0						
1R1	1.1						
1R3	1.3						
1R4	1.4						
1R5	1.5						
1R6	1.6						
1R7	1.7						
1R8	1.8						
1R9	1.9						
2R0	2.0						
2R1	2.1						
2R2	2.2						
2R4	2.4						
2R7	2.7						
3R0	3.0						
3R3	3.3						
3R6	3.6						
3R9	3.9						
4R3	4.3						
4R7	4.7						
5R1	5.1						
5R6	5.6						
6R2	6.2						
6R8	6.8						
7R5	7.5						
8R2	8.2						
9R1	9.1						
100	10						
110	11						
120	12						
130	13						
150	15						
160	16						
180	18						
200	20						
220	22						
240	24						
270	27						
300	30						
330	33						
360	36						
390	39						
430	43						
470	47						
510	51						
560	56						
620	62						
680	68						
750	75						
820	82						
910	91						
101	100						
111	110						
121	120						
151	150						
181	180						
221	220						
271	270						
331	330						
391	390						
471	470						
511	510						
561	560						
621	620						
681	680						
821	820						
911	910						
102	1000						
Reel QTY		5000	4000	2350	5000	3500	2350
Horizontal							

Special capacitance values available upon request.

# MLC - UL Series: Ultra Low ESR Ceramic Capacitors

ESR vs Frequency DLI C04 UL Series

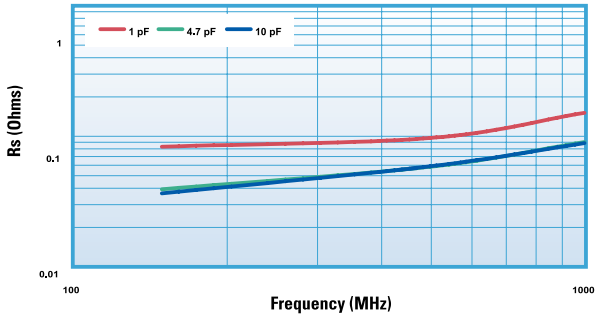

ESR vs Frequency DLI C06 UL Series

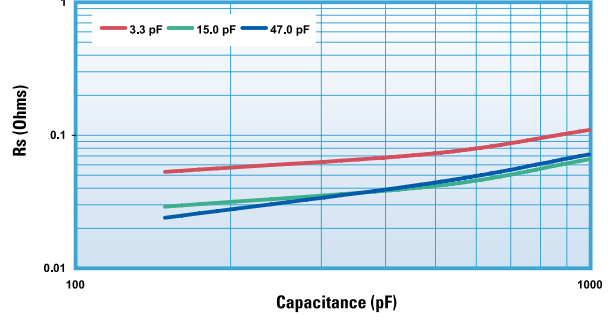

ESR vs Frequency DLI C07 UL Series

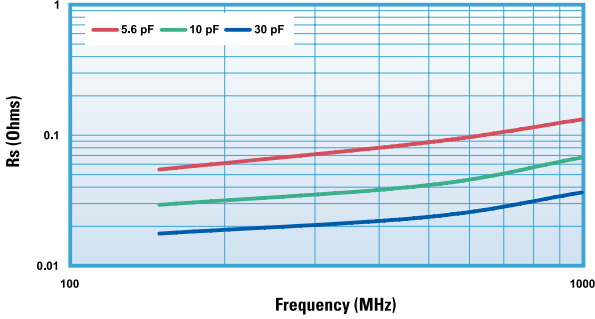

ESR vs Frequency DLI C08 UL Series

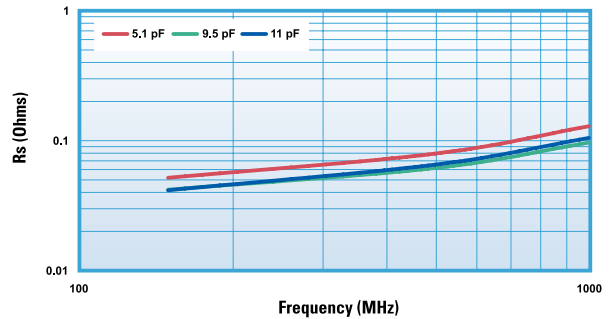

ESR vs Frequency DLI C11 UL Series

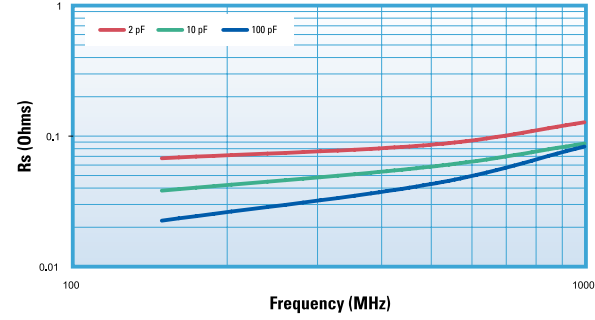

ESR vs Frequency DLI C17 UL Series

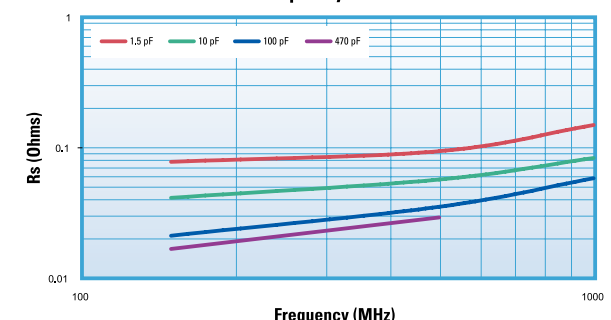

Q vs Capacitance DLI C04 UL Series

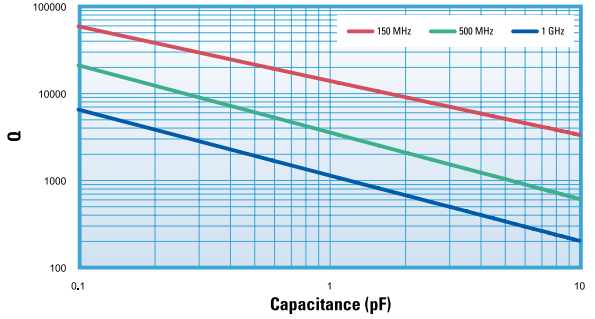

Q vs Capacitance DLI C06 UL Series

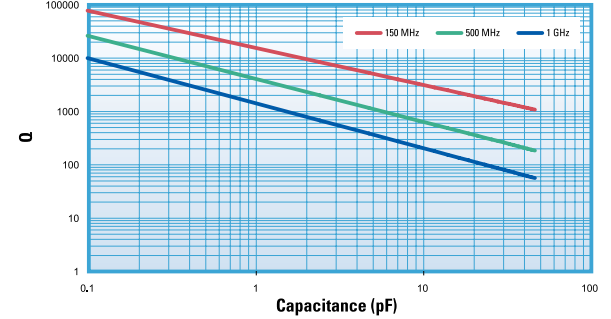

Q vs Capacitance DLI C07 UL Series

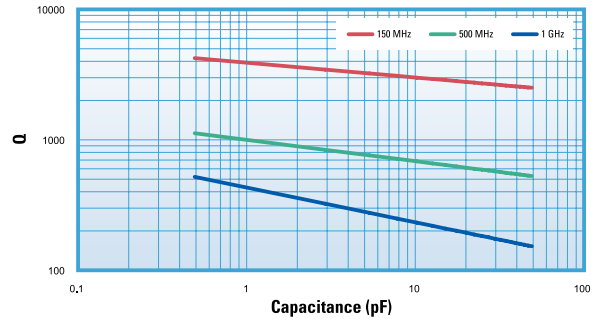

Q vs Capacitance DLI C08 UL Series

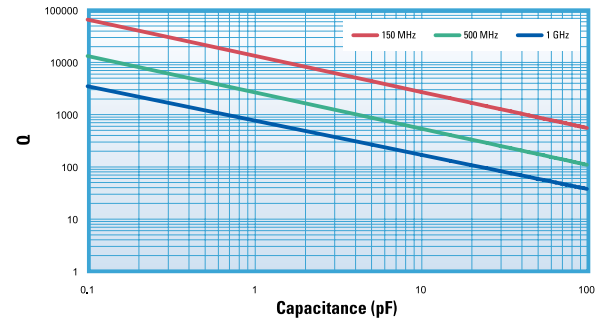

The information above represents typical device performance.

# MLC - UL Series: Ultra Low ESR Ceramic Capacitors

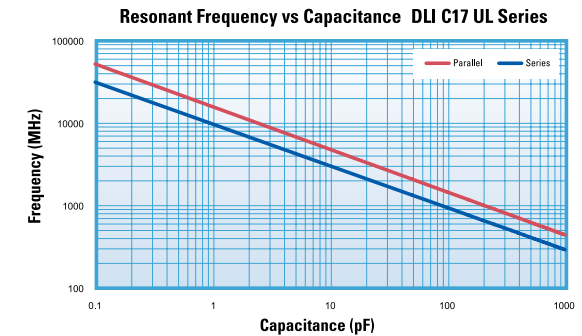
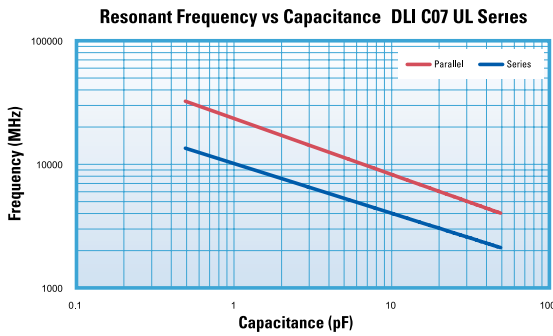
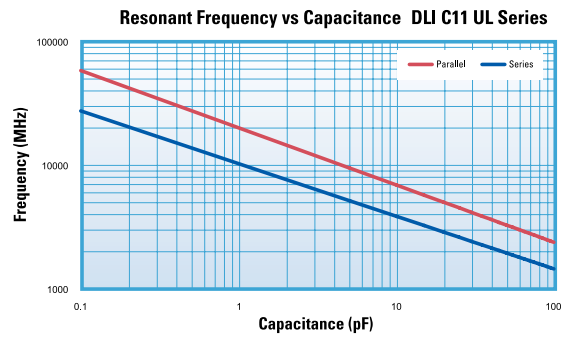
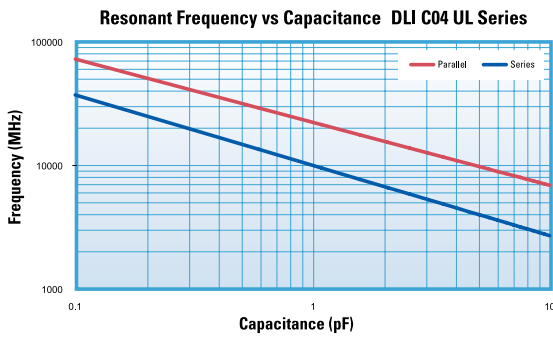
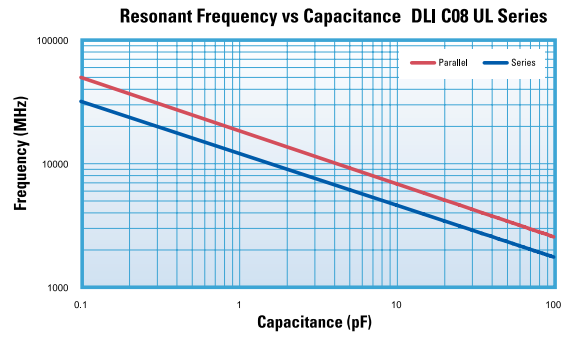
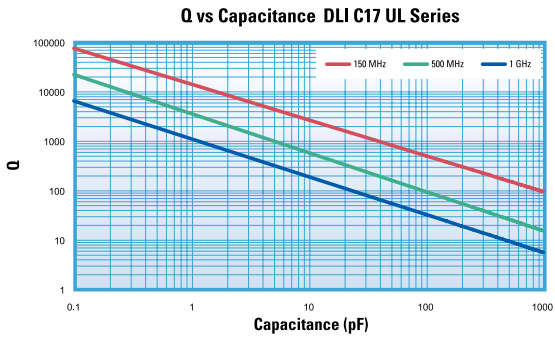
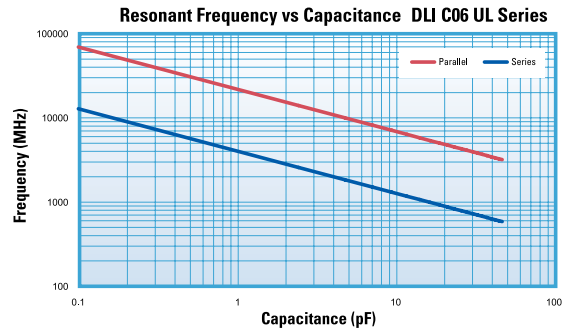
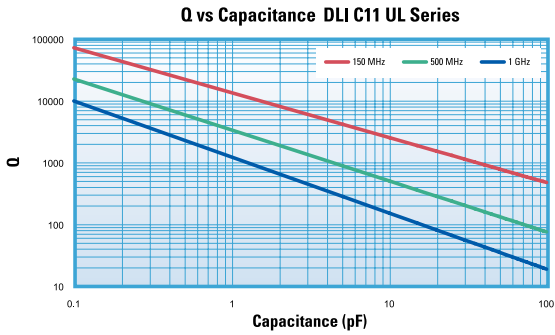

The information above represents typical device performance.

**Part Number** See Page 28 for complete part number system.

<b>C</b>	<b>17</b>	<b>UL</b>	<b>620</b>	<b>J-</b>	<b>7</b>	<b>U</b>	<b>N-</b>	<b>X</b>	<b>0</b>	<b>T</b>
MLC Capacitor	Case Size	Material System	Capacitance Code	Tolerance Level	Voltage Code	Termination Code	Leading Code	Test Level	Marking Code	Packaging

Terminations		Lead Types		Test Level - All Case Sizes		Laser Marking		Packaging	
C04	S	C04/6/7/8	N	X	Standard	C04	0	C04/6	T, W, B, P, S
C06	U, S, Z,	C11	A, B, D	Y	Reduced Visual	C06	0, 1, 2	C07	W, B, P, S
C07	S, Z,	C17	A, B, C, D, E, F	A	MIL-PRF-55681 Group A	C07	0, 1	C08/11/17	T, V, W, B, P, S
C08/11/17	U, S, Z,	*Special leading requirements available.		C	MIL-PRF-55681 Group C	C08/11/17	0, 1, 2		
				D	Customer Specified				



# High Q Capacitors - C04, C06, C11 and C17 Kits

## C04 Engineering Kit

10 Pieces Each of 15 Values

Code	Cap
0R3	0.3pF
0R5	0.5pF
1R0	1.0pF
1R2	1.2pF
1R5	1.5pF
1R8	1.8pF
2R0	2.0pF
2R2	2.2pF
2R7	2.7pF
3R3	3.3pF
3R9	3.9pF
4R7	4.7pF
5R6	5.6pF
6R8	6.8pF
100	10pF
<b>C04 Broadband Block</b>	<b>120pF</b>

## C04 Designer Kit

10 Pieces Each of 8 Values

Kit C	Kit D	Kit E
0R1	0R9	3R9
0R2	1R0	4R7
0R3	1R2	5R1
0R4	1R5	5R6
0R5	1R8	6R8
0R6	2R2	8R2
0R7	2R7	9R1
0R8	3R3	100

## C06 Engineering Kit

10 Pieces Each of 21 Values

Code	Cap
0R3	0.3pF
0R5	0.5pF
1R0	1.0pF
1R2	1.2pF
1R5	1.5pF
1R8	1.8pF
2R0	2.0pF
2R2	2.2pF
2R7	2.7pF
3R3	3.3pF
3R9	3.9pF
4R7	4.7pF
5R6	5.6pF
6R8	6.8pF
100	10pF
150	15pF
180	18pF
220	22pF
270	27pF
330	33pF
470	47pF
<b>C06 Broadband Block</b>	<b>850pF</b>

## C06 Designer Kit

10 Pieces Each of 10 Values

Kit C	Kit D	Kit E
0R1	1R2	6R8
0R2	1R5	8R2
0R3	1R8	9R1
0R4	2R2	100
0R5	2R7	120
0R6	3R3	150
0R7	3R9	220
0R8	4R7	270
0R9	5R1	330
1R0	5R6	470

## C11 Engineering Kit

10 Pieces Each of 28 Values

Code	Cap
0R3	0.3pF
0R5	0.5pF
0R7	0.7pF
1R0	1.0pF
1R2	1.2pF
1R5	1.5pF
1R8	1.8pF
2R0	2.0pF
2R2	2.2pF
2R7	2.7pF
3R3	3.3pF
3R9	3.9pF
4R7	4.7pF
5R6	5.6pF
6R8	6.8pF
8R2	8.2pF
100	10pF
120	12pF
150	15pF
180	18pF
270	27pF
330	33pF
390	39pF
470	47pF
560	56pF
680	68pF
820	82pF
101	100pF
<b>C08 Broadband Block</b>	<b>2400pF</b>

## C11 Designer Kit

10 Pieces Each of 10 Values

Kit C	Kit D	Kit E	Kit F
0R1	1R0	5R6	270
0R2	1R2	6R8	330
0R3	1R5	8R2	390
0R4	1R8	100	470
0R5	2R2	120	510
0R6	2R7	150	560
0R7	3R3	180	620
0R8	3R9	220	680
0R9	4R7	270	820
1R0	5R1	330	101

## C17 Engineering Kit

10 Pieces Each of 35 Values

Code	Cap
0R3	0.3pF
0R5	0.5pF
0R7	0.7pF
1R0	1.0pF
1R2	1.2pF
1R5	1.5pF
1R8	1.8pF
2R0	2.0pF
2R2	2.2pF
2R7	2.7pF
3R3	3.3pF
3R9	3.9pF
4R7	4.7pF
5R6	5.6pF
6R8	6.8pF
8R2	8.2pF
100	10pF
120	12pF
150	15pF
180	18pF
220	22pF
270	27pF
330	33pF
390	39pF
470	47pF
560	56pF
680	68pF
820	82pF
101	100pF
151	150pF
221	220pF
331	330pF
471	470pF
681	680pF
102	1000pF
<b>C08 Broadband Block</b>	<b>2400pF</b>

## C17 Designer Kit

10 Pieces Each of 10 Values

Kit C	Kit D	Kit E	Kit F
0R1	1R0	5R6	390
0R2	1R2	6R8	470
0R3	1R5	8R2	560
0R4	1R8	100	680
0R5	2R2	120	820
0R6	2R7	150	101
0R7	3R3	180	221
0R8	3R9	220	471
0R9	4R7	270	681
1R0	5R1	330	102



DLI reserves the right to substitute values as required. Customers may request particular cap value and material for sample kit to prove out designs. Custom kits available upon request.

# Broadband Blocks - C04/C06/C08

## Description

- Resonance free DC Blocking / Decoupling
- Less than 0.25 db loss @ 4 GHz (typical)
- Surface mountable

## Functional Applications

- Fiber Optic Links • High Isolation Decoupling
- LAN's, VCO Frequency Stabilization • Diplexers
- RF/Microwave Modules • Instruments • Test Equipments

## Mechanical Specification

Product Code	Body Dimensions			Band Dimensions (B)	
	Length (L)	Width (W)	Thickness (T)	Min	Max
C04BL	0.040" ± 0.008"	0.020" ± 0.006"	0.028" Max	0.003"	0.019"
C06 BL	0.060" ± 0.012"	0.031" ± 0.009"	0.036" Max	0.006"	0.03"
C08 BL	0.081" ± 0.020"	0.051" ± 0.013"	0.061" Max	0.012"	0.0468"
C18BL	0.1200" ± 0.925"	0.1100" ± 0.010"	0.100" Max	0.008"	0.045"

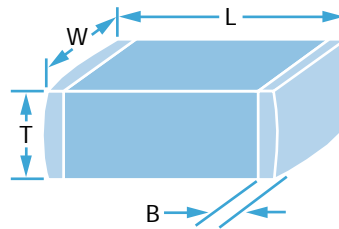

## Part Characteristics

Part Number	Capacitance Guaranteed Minimum Value	Voltage Rating	Temperature Coefficient -55°C to 125°C	Maximum Dissipation Factor	Insulation Resistance (MΩ Minimum)	Aging Rate	Frequency Range	Termination
C04BL121X-5UN-X0T	120pF @ 1KHz, .2Vrms	50 Vdc	± 15%	3.0% @ 1KHz, .2Vrms	10 <sup>4</sup>	<=1.5%/decade hours	10MHz – 40GHz	"U" & "S"
C06BL851X-1UN-X0T	850pF @ 1KHz, .2Vrms	100 Vdc 50 Vdc					2MHz – 30GHz	"U", "S" & "Z"
C08BL242X-5UN-X0T	2400pF @ 1KHz, .2Vrms	50 Vdc					1MHz – 20GHz	"U", "S" & "Z"
C08BL102X-1UN-X0T	1000pF @ 1KHz, .2Vrms	100 Vdc					1MHz – 20GHz	"U", "S" & "Z"
C18BL103X-4GN-X0T	10,000pF @ 1KHz, .2Vrms	500 Vdc					1MHz – 6GHz	"U", "S" & "Z"

## Performance

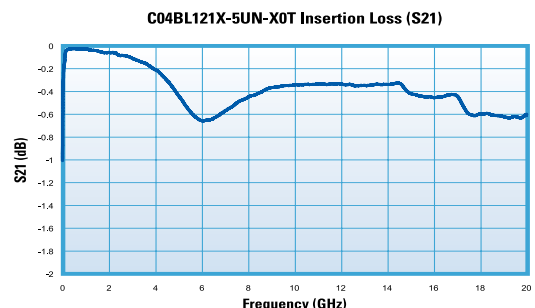
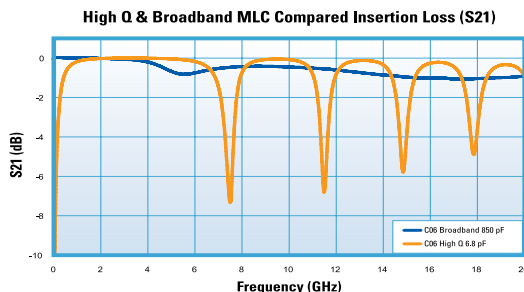
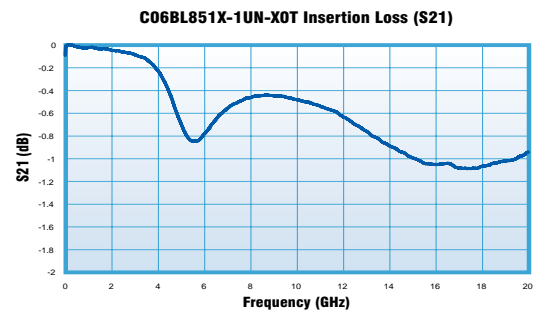
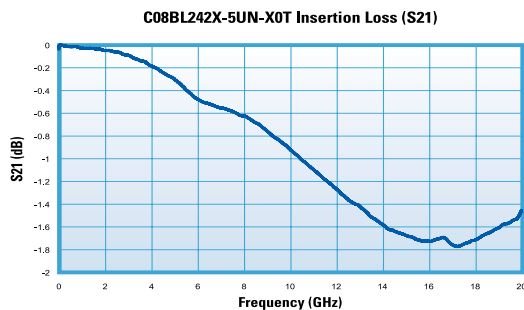

The information above represents typical device performance.

# Broadband Blocks - Opti-Cap<sup>®</sup>

## Description

- Resonance Free DC Blocking to >40GHz
- Surface Mountable by Solder or Epoxy Bonding
- Available in Tape & Reel or Waffle Pack Format
- Low Frequency Stability over Temperature
- Very Low Series Inductance
- 0201, 0402 or 0603 footprints

## Functional Applications

- Improved Low Frequency Stability over Temperature
- Very Low Series Inductance
- X7R Temperature and Voltage Stability

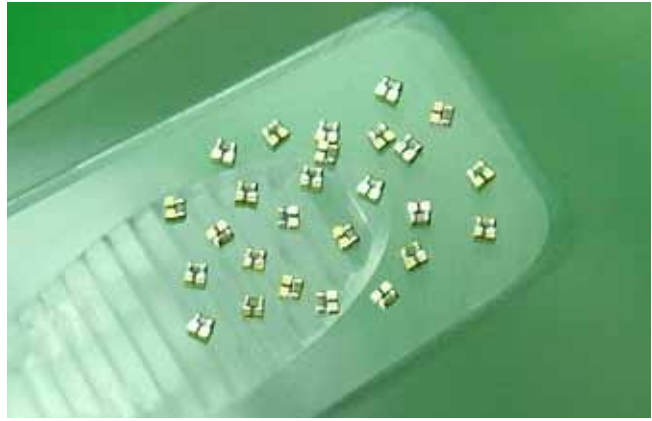

## Case Sizes

Case Size	Milli-Cap <sup>®</sup>			MLC		
	Length (L)	Width (W)	Thickness (T)	Length (L)	Width (W)	Thickness (T)
<b>P21 (0201)</b>	0.022" ± 0.006"	0.012" ± 0.002"	0.012" ± 0.002"	0.022" ± 0.002"	0.011" ± 0.001"	0.011" ± 0.003"
<b>P42 (0402)</b>	0.038" ± 0.004"	0.020" ± 0.002"	0.020" ± 0.002"	0.040" ± 0.002"	0.020" ± 0.002"	0.020" ± 0.002"
<b>P62 (0603)</b>	0.058" ± 0.003"	0.020" ± 0.002"	0.020" ± 0.002"	0.067" ± 0.004"	0.031" ± 0.004"	0.031" ± 0.005"

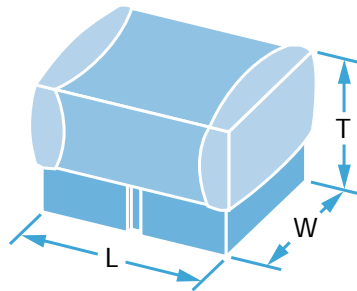

## Part Numbers

Part Number	Capacitance		Voltage Rating	TCC	IR @ +20°C	DF @ 1KHz	Aging Rate %/Decade Hr	Freq. Range 3dB (TYP)
	MLC	Milli-Cap <sup>®</sup>						
<b>P21BN300MA03976</b>	10nF	30pF	10V	X5R	>10 <sup>2</sup> MΩ	3.5%	1.0%	16KHz- >40GHz
<b>P21BN300MA04282</b>	22nF	30pF	10V	X5R	>10 <sup>2</sup> MΩ	3.5%	1.0%	
<b>P21BN300MA04572</b>	22nF	30pF	10V	X5R	>10 <sup>2</sup> MΩ	3.5%	1.0%	
<b>P21BN300MA04678</b>	1.5nF	30pF	10V	X5R	>10 <sup>2</sup> MΩ	3.5%	1.0%	
<b>P21BN300MA04733</b>	100nF	30pF	10V	X5R	>10 <sup>2</sup> MΩ	3.5%	1.0%	
<b>P42BN820MA03152</b>	220nF	82pF	10V	X5R	>10 <sup>2</sup> MΩ	3.5%	1.0%	
<b>P42BN820MA04679</b>	22nF	82pF	50V	X7R	>10 <sup>2</sup> MΩ	3.5%	1.0%	
<b>P62BN820MA02636</b>	100nf	82pF	10V	X7R	>10 <sup>2</sup> MΩ	3.5%	1.0%	

## Notes:

- X5R: -55°C to +85°C ΔC ±15%
- X7R: -55°C to +125°C ΔC ±15%
- Termination Metallization 7.5μ" Au over 50μ" Ni
- Recommended attachment is solder or conductive epoxy
- Maximum assembly process temperature 250°C
- For best high frequency performance attach Milli-Cap<sup>®</sup> side to transmission line
- Recommended microstrip gap length is 0.015"

# Broadband Blocks - Opti-Cap®

## Attachment Methods

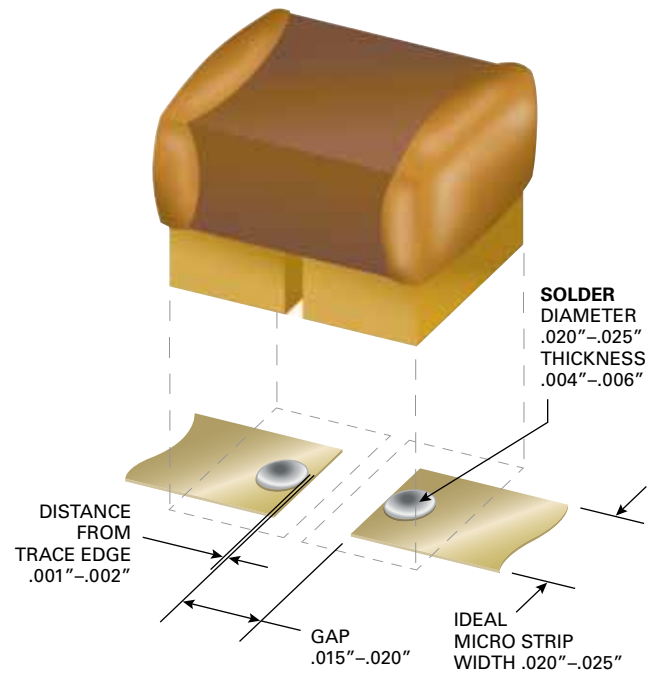
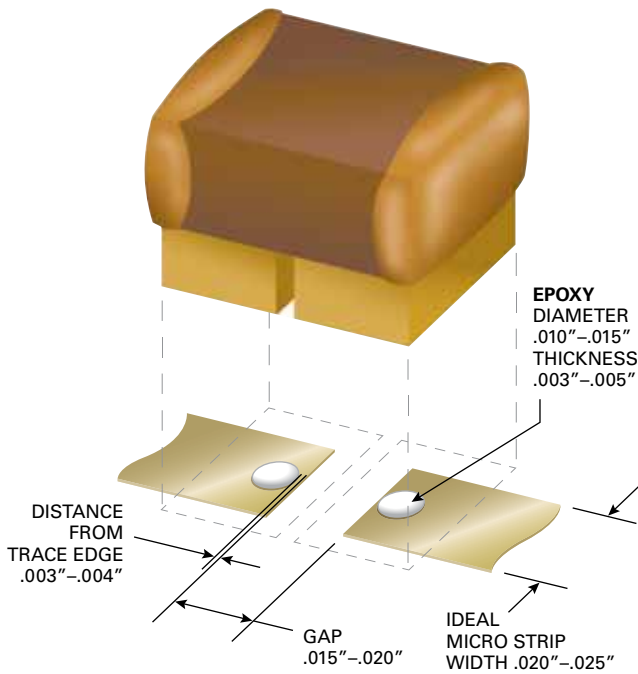

### Recommended Attachment to Soft or Hard Substrate Using Conductive Epoxy:

1. Place a single drop of conductive epoxy onto each micro strip as illustrated; the edge of the epoxy shall be at least .003"-.004" back from the edge of the trace to prevent filling the gap with epoxy.
2. Centering the termination gap of the capacitor within the gap in the micro strip, press with careful, even pressure onto the micro strip ensuring the terminations make good contact with the epoxy drops.
3. Cure according to the epoxy manufacturer's preferred schedule, typically 125°C to 150°C max.
4. After curing, inspect joint for epoxy shorts across the termination and micro strip gaps that would cause a short across the cap.

Isopropanol, and Methanol are both safe to use to pre clean Opti-Caps®.

**Isopropanol, and Methanol are not to be used after mounting with conductive epoxy as they act as a solvent!**

### Recommended Attachment to Soft or Hard Substrate Using Solder:

1. Place a single drop of solder paste onto each micro strip as illustrated; the edge of the solder shall be at least .001"-.002" back from the edge of the trace to prevent filling the gap with solder.
2. Centering the termination gap of the capacitor within the gap in the micro strip, press with careful, even pressure onto the micro strip ensuring the terminations make good contact with the drops of solder paste.
3. Reflow according to the solder manufacturer's preferred profile, ensuring the reflow temperature does not exceed 250°C.
4. After the reflow step is completed, inspect joint for voids or excess flux and non-reflowed solder balls that can degrade performance or cause shorts across the gaps. Proper cleaning after the reflow process is crucial to avoiding performance degradation and discovering poor solder joints.

Isopropanol, and Methanol are both safe to use with soldered Opti-Caps®.

# Broadband Blocks - Opti-Cap®

**P21BN300MA3976 Opti-Cap**  
 Typical Performance  
 (Reference 50 Ohm System)

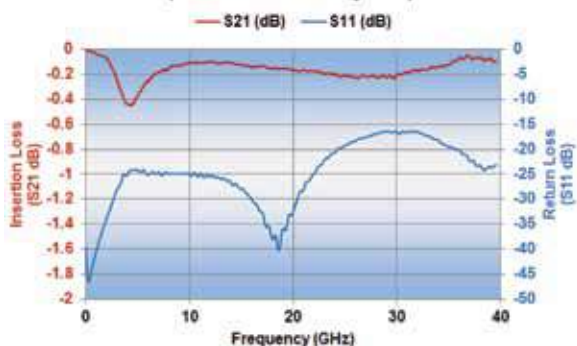

**P21BN300MA4282 Opti-Cap**  
 Typical Performance  
 (Reference 50 Ohm System)

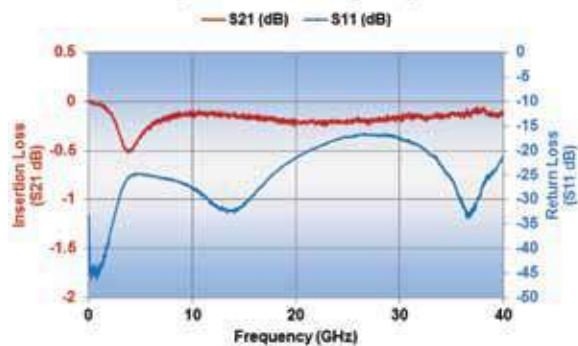

**P21BN300MA4572 Opti-Cap**  
 Typical Performance  
 (Reference 50 Ohm System)

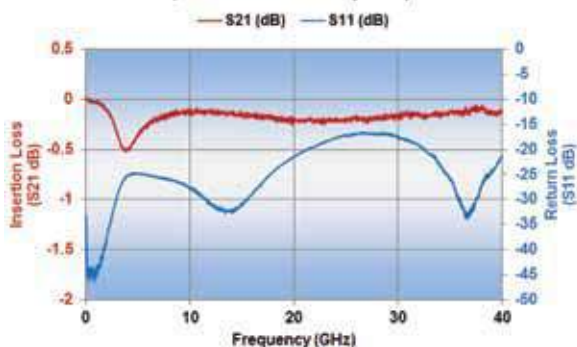

**P21BN300MA4678 Opti-Cap**  
 Typical Performance  
 (Reference 50 Ohm System)

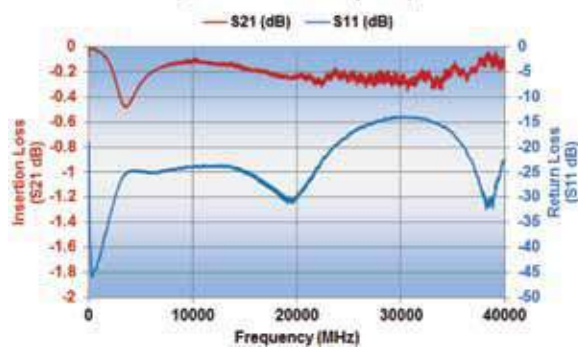

**P21BN300MA04733 Opti-Cap**  
 Typical Performance  
 (Reference 50 Ohm System)

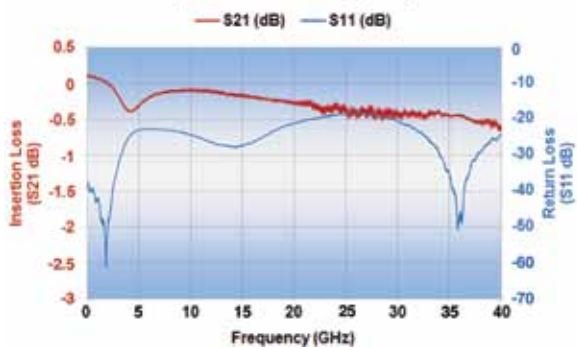

**P42BN300MA3182 Opti-Cap**  
 Typical Performance  
 (Reference 50 Ohm System)

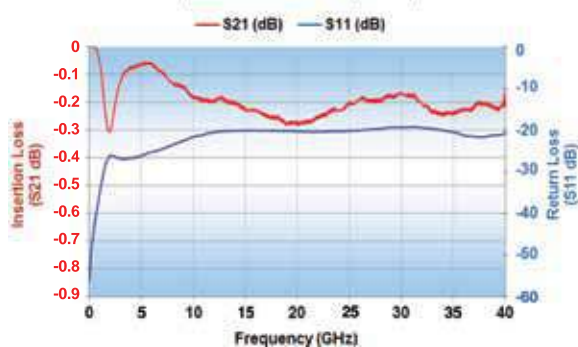

**P42BN300MA4679 Opti-Cap**  
 Typical Performance  
 (Reference 50 Ohm System)

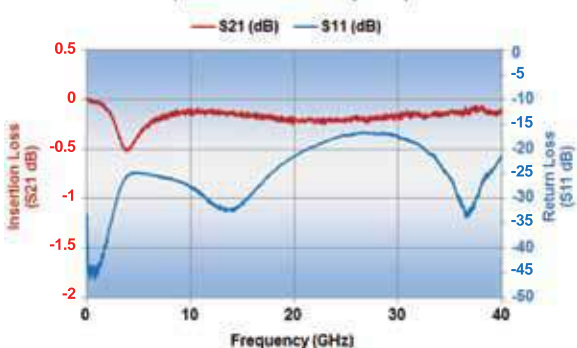

**P62BN300MA2636 Opti-Cap**  
 Typical Performance  
 (Reference 50 Ohm System)

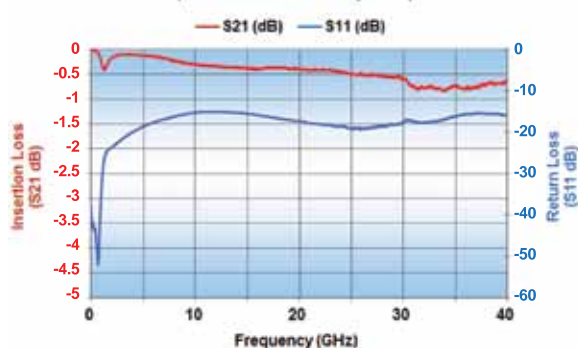

# Broadband Blocks - Milli-Cap® SMD Millimeter Wave Capacitor

## Description

- 0402, 0502 & 0602 Footprints
- Low Loss High Q part
- Very Low Series Inductance
- Ultra High Series Resonance
- Matches typical 50Ω Line Widths
- Preserves Board Space
- Behaves Like An Ideal Capacitor
- More Usable Bandwidth

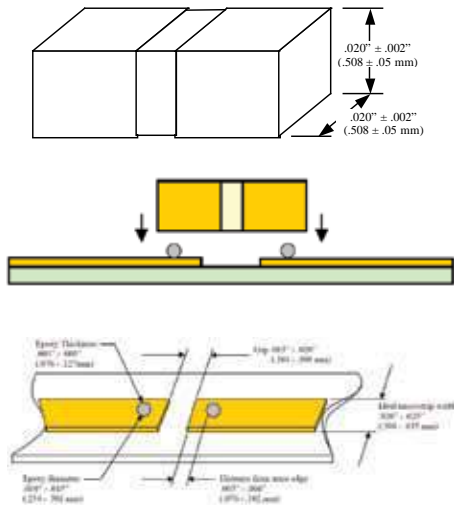

## Functional Applications

- Ideal for Test Equipment, Photonics, SONET, Digital radios, and Matching Filter applications

## Mechanical Specification

- Terminations: Gold
- Assembly temperatures not to exceed 260°C.

## Electrical Characteristics

Part Number	Cap.	Voltage Rating	Temperature Coefficient -55°C to 125°C	Maximum Dissipation Factor @25°C	Insulation Resistance (MΩ Minimum)	Aging Rate	Frequency Range
P_2BN820Z5ST	82 pF	50 Vdc	± 10%	3.0% @1MHz	10 <sup>5</sup> MΩ @ 25°C at rated voltage	<=1.5%/decade hrs	20MHz– 40GHz
P_2NR3R0K5ST	3.0 pF		N1500 ±500PPM / °C	0.25% @1MHz	10 <sup>6</sup> MΩ @ 25°C at rated voltage		4–20GHz
P_2CG1R5C5ST	1.5 pF		0 ± 30PPM	0.7% @1KHz			8–32GHz
P_2CG1R0C5ST	1.0 pF		N20 ±15PPM / °C	0.15% @1MHz			18–40GHz
P_2CD0R7B5ST	0.7 pF			20–46GHz			
P_2CF0R5B5ST	0.5 pF		0 ±15PPM / °C	0.6% @1KHz			28–40GHz
P_2CF0R3B5ST	0.3 pF				35–50GHz		

Dimensions Key: P42 = 0402; P02 = 0502; P62 = 0602

**Electrical Performance** The information below represents typical device performance.

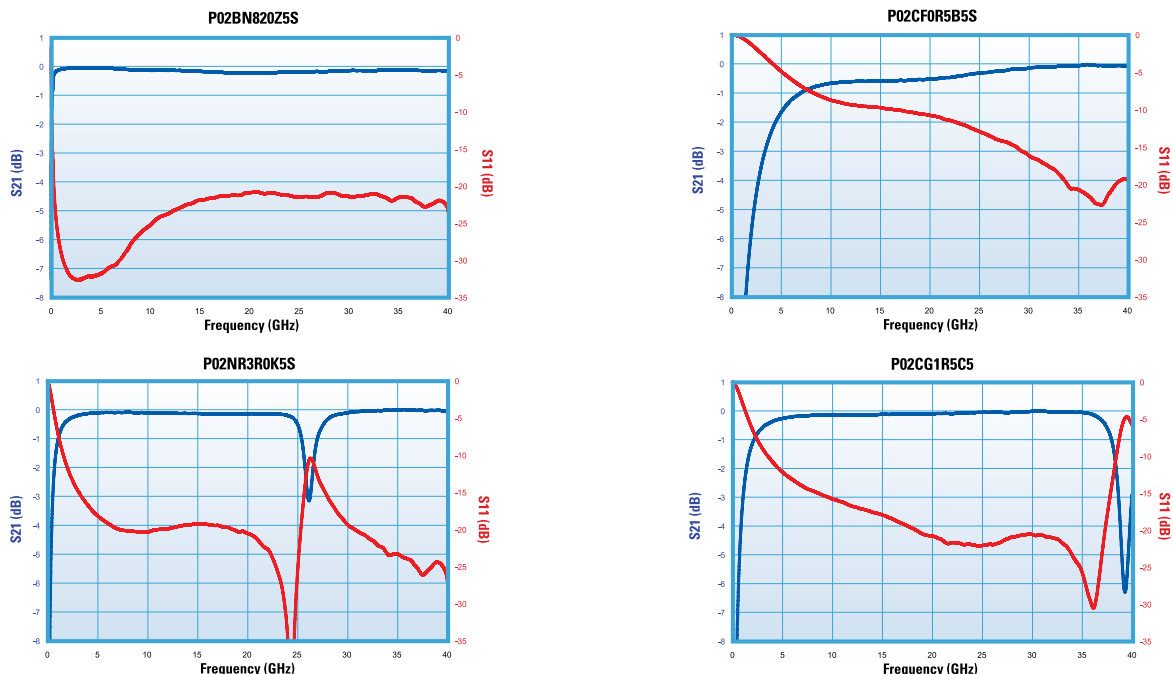

# Broadband Blocks - Miniature RF Blocking Network

## Description

For RF Noise Suppression in high speed mixed signal semiconductor devices

- Eliminates Noise at I/O Pins
- Replaces Large Decoupling Capacitor
- with Superior Performance
- Clean DC Lines Beyond 18 GHz

## Functional Applications

- High Speed Digital • Mixed Signal IC's
- Suppression of Noise on DC Supply Lines
- MCM and Hybrid Modules
- X7R Temperature and Voltage Stability

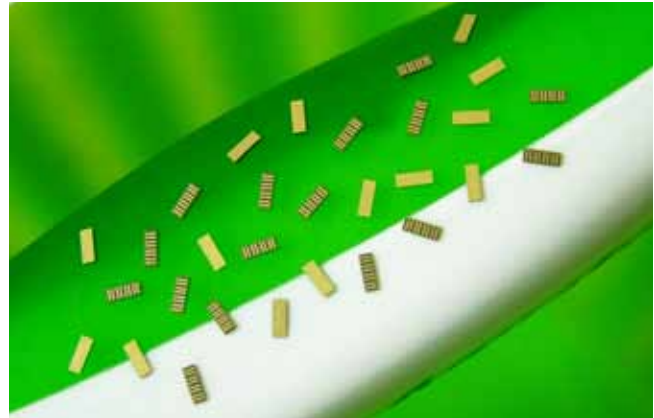

## Layout and Dimensions

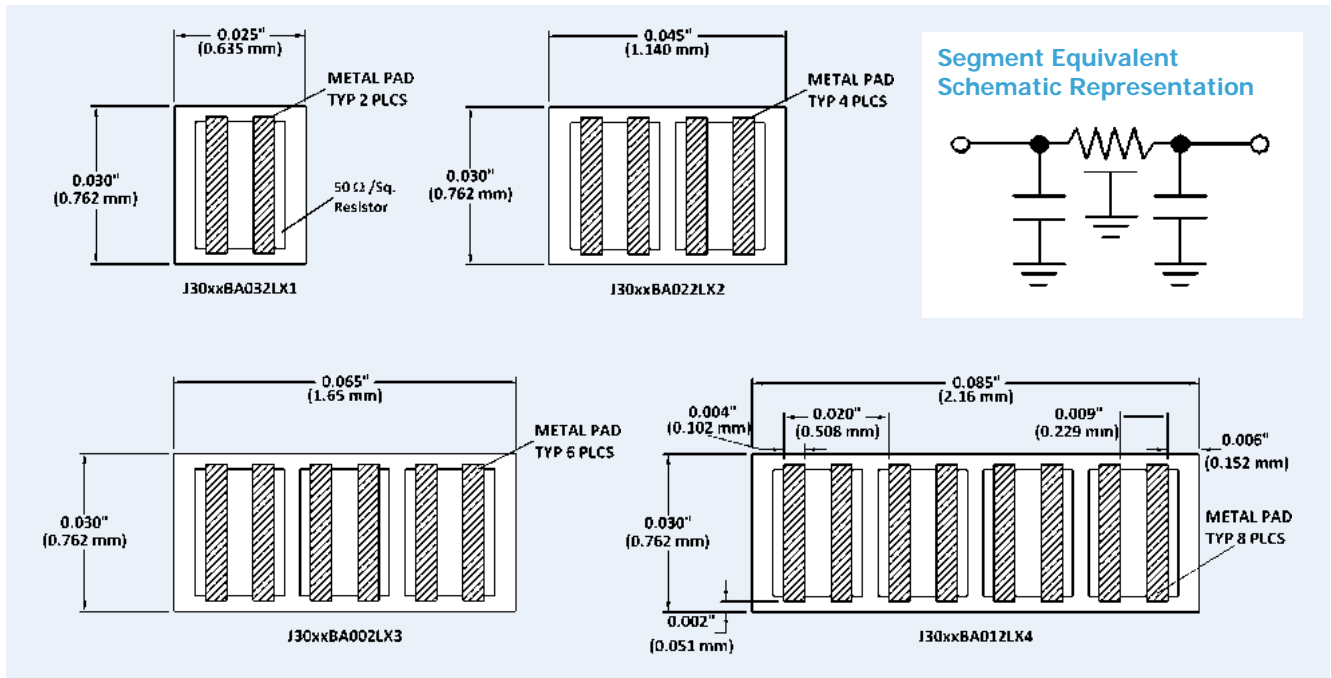

## Part Number Identification

<b>J</b>	<b>30</b>	<b>XX</b>	<b>BA01</b>	<b>2</b>	<b>L</b>	<b>X</b>	<b>4</b>
<b>Product</b> J = Blocking Network	<b>Width (Mils)</b>	<b>Material</b> BL or BJ	<b>Internal Drawing Reference</b>	<b>Voltage</b> 2 = 25 Vdc	<b>Metallization</b> 100µ" Gold Finish	<b>Test Level</b> Commercial	<b>Number of RC Segments</b>

## Material and Electrical Characteristics

Material Code	Capacitance (typical)	Resistance (pad to pad)	DF	TCC	Rated Voltage
BL	30 pF	10Ω Nom.	3.0% Max.	X7R	25 Vdc
BJ	45 pF	10Ω Nom.	3.0% Max.	X7R	25 Vdc

# Thin Film - Miniature RF Blocking Network

## Metallization:

**Top:** 50•/Square TaN, 300Å TiW, 100 • Inch minimum Au.

**Bottom:** 300Å TiW, 100 • Inch minimum Au.

## Screening Options

Test Code	Test/Inspection	Sample Size	Description
X	Bond Strength	2 Pcs/Plate	2 bonding pads on each sample
	IR	1% AQL	21/2 times rated voltage of 25 volts
	Visual Inspection	100%	4 Side visual screening
	Pad to pad resistance check	1% AQL	Ensure isolation between segments and boarder

## Performance

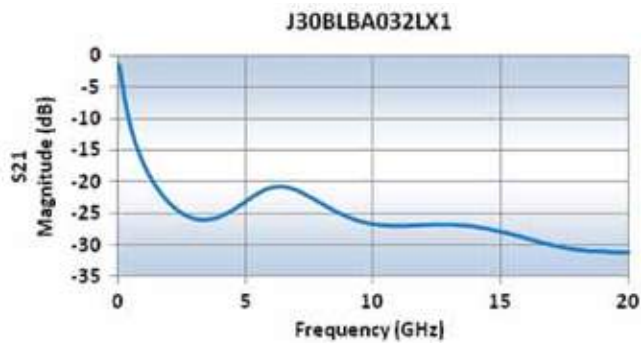

## Segment Bonding for Measurement



For additional data of multi-segment devices please contact an inside sales representative.

## Typical Application

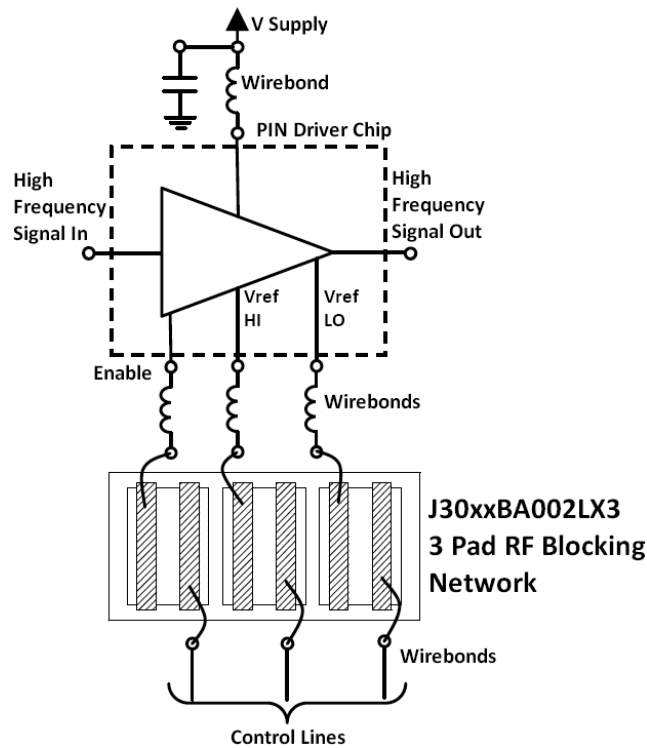



# Thin Film - RF Guru Ceramic Filter Request Form

This is an example of the form you'll find on the DLI website (<http://dliextra.net/DLIFilterGuru/RFGuru.aspx>)

It was developed as a template to make it easy for our customers to enter the information DLI needs for an initial assessment of filter performance, size and cost.



Fill out the "RF Guru" filter request form and your requirement will be automatically sent to DLI engineering.

After submitting this form DLI Applications Engineering will contact you. From these discussions DLI will provide you with further information about possible topologies and predicted filter performance. Then you can decide if a filter on a high-k dielectric is the right option for you.

Please note: This is not an order form. There is no obligation until you are confident in our capabilities and actually decide to place an order.

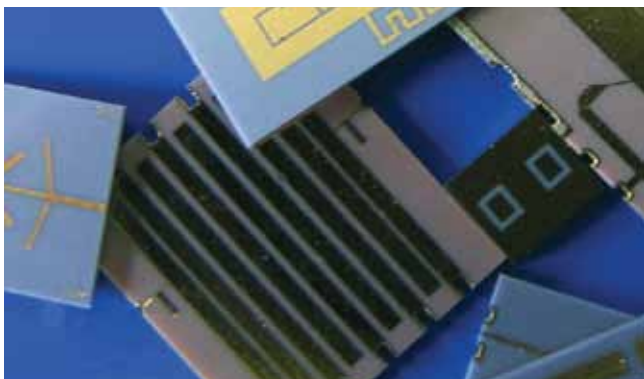
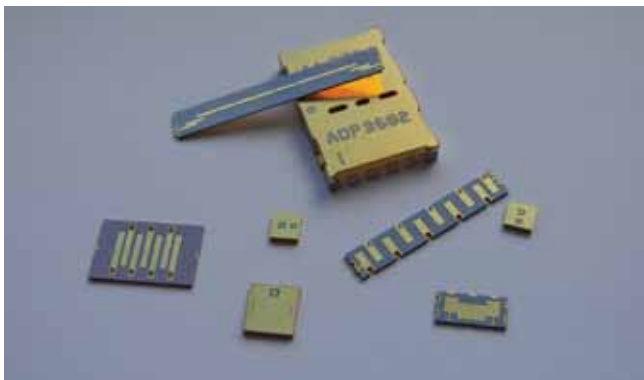
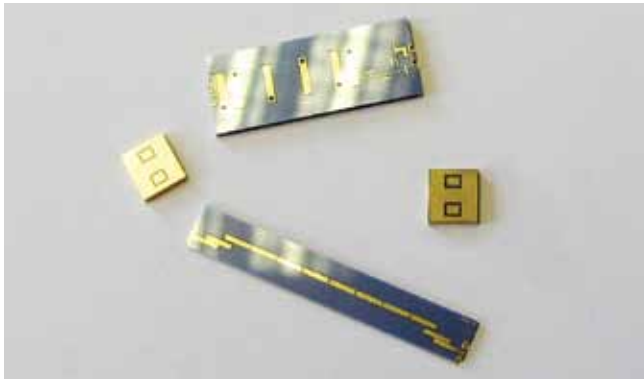
If you're looking for a catalog off the shelf solution you might find our EAR99 classified catalog filters on the following pages helpful.



ETP RF Guru
ETP RF Guru
Cat Cat

### FILTER REQUEST FOR INFORMATION FORM

This form is designed as a template to make it easy for our customers to enter the information DLI needs for an initial assessment of filter performance, size and cost. After submitting this form DLI Applications Engineering will contact you. From these discussions DLI will provide you with further information about possible topologies and predicted filter performance. Then you can decide if a filter on a high-k dielectric is the right option for you. Please note: This is not an order form. There is no obligation until you are confident in our capabilities and actually decide to place an order.

**DLI Filter Typical Specification\***

- Up to 25 GHz RF power
- 20 dB loss
- Up to 10% tolerance bandwidth and 1% size performance
- Free of any self-generated harmonic distortion/intermodulation products
- High k technology provides improved field confinement, high Q and better isolation
- Meeting a high temperature stability and low EMI emission

\*Typical Performance Specifications are for reference only. Please consult DLI Applications Engineering with your unique requirements.

**Contact Information:**

To facilitate better discussion of your requirements please provide your contact information below.

If possible, please provide filter length in a multiple of 100 mil (2.54 mm). This will speed up manufacturing and delivery time. If you don't have exact dimensions or want the filter to operate at a wide range, please provide the filter length in mm.

**DLI Filters Require Curves**

I want DLI to provide the curves.  
 I will provide my own curves.

**Electrical Specification**

Please enter the desired Filter Center Frequency (symmetric or asymmetric about the upper and lower cutoff frequencies). If you have specific requirements such as a 3dB cutoff instead of 50dB you may have a maximum return loss and noise floor you may prefer. The information on the attenuation section DLI filters usually offer very different levels at the 2 GHz to 50 GHz range. Please find design and layout to be less conservative unless your application needs otherwise to be conservative.

\*Please note that DLI filter is an inherently reciprocal and pass and it is placed between 2 DLI filter application sections.

Center Frequency	1000	3000
Bandwidth	1000	3000
3dB Bandwidth		3000
Return Loss (Passband)		%

It is good idea to leave the maximum loss of a filter to make the bandwidth as high as possible. In general if it is not 3dB it is more something that has been done a 1% tolerance bandwidth or try to keep the band width in your system in the range 0-10% or you will not a higher loss figure. To get the maximum bandwidth from the 3dB bandwidth, divide the 3dB bandwidth by the filter center frequency and convert the loss to percent.

DLI never to change the filter to the broad possible insertion loss for a given specification. For our initial assessment, I can request to know if your application has a hard limit for insertion loss.

DLI will design a filter to have a low and even return loss in the pass band but we need to know if your design requirements dictate a maximum level of the 3dB Return values are -10dB, -15dB or -20dB etc. If you prefer 10dB Return (average 20%) you can specify that as well.

**Attenuation Specification**

Design and please your attenuation specifications from Customer requirements, design requirements to improve, and if band rejection of interest is 10dB need to know if it is an even value. The most appropriate filter topology. If your circuit is needed to succeed in this filter response please indicate the amount of loss required.

**Dimensional Specifications Details**

Do you need a test fixture with the filter and if so what connections to you give to use?

Are there any special test requirements or application specific requirements such as: temperature range, test documentation or mounting information, special qualifications etc?

**NRE Fee Information**

If the requirements results in the need to create a new design DLI may charge for design, materials, test setup and engineering time, commonly referred to as NRE. If this is a problem DLI can sometimes provide a quote for the initial prototype quantities of the filter for able to make other arrangements based upon special considerations such as the size of the program. To prepare a budgetary quote it is important to know if you want to have the NRE paid as a lump sum or divided up.

We prefer to pay NRE as a lump sum - if it is required.  
 We will complete this as the NRE costs, please advise the NRE cost and add to the filter cost price.

**Budgetary Volume**

Why we are interested in this many. When your project is going to meet your next year or so (or more) we would like to know about it as you give the best possible price information. DLI has no cost with our volume projects with high performance requirements. If you will get a high volume it is also not an issue but we need to know for a precise quotation. Your best estimate is fine.

**Target Price**

DLI understands that price is an important factor to take into account at the beginning of the design cycle. DLI may not always give the lowest cost solution but also achieves the best return price, service time and best temperature stability, designed to meet your requirements in the marketplace. This is especially true at higher frequencies. DLI will use the lowest price and volume production when designing practical solutions. We will advise if we are unable to meet your price target.

**What type of response would best describe what you are looking for?**

Please select the alternative that most appropriately describes what you expect us to provide for you.

DLI appreciates your time and effort, a DLI Applications Engineer will contact you to discuss your filter requirements.

You can also print and fax this form to our fax line: (313) 555 9640

# Thin Film - Ceramic Filters

## Typical Filter Types:

- Bandpass Filters from 500MHz - 67GHz
- Lowpass Filters from 500MHz - 67GHz
- Highpass Filters from 500MHz - 67GHz
- Notch Filters from 500MHz - 67GHz
- Duplexers and Diplexers from 1GHz - 30GHz
- Cavity Filters from 6GHz - 25GHz

## Typical Characteristics:

- RF power handling up to 20 watts (function of topology, BW and other variables)
- Steep selectivity (number of poles) "n" - 2 to 20 poles
- Fractional bandwidths up to 80%
- Low insertion loss
- Flat amplitude ripple and group delay
- Solder-surface mount designs
- Chip and wire designs

## Typical Filter Topologies:

- Interdigital
- End Coupled
- Edge Coupled
- Hair Pin
- Edge - End Coupled
- Comblines and Pseudocomblines
- Dual Mode
- Quasi-lumped

## Advantages of DLI High K Ceramics and Thin Film Processing:

- Size reduction over Alumina and PWB materials
- Extremely temperature stable from -60°C to +125°C
- Thin Film Precision - Tight geometry tolerance
- High repeatability and no tuning required
- Improved field confinement
- Lower CTE mismatch in SMT applications: Smaller size and low CTE ----> Less stress, and higher reliability

**Note:** 67GHz is an artificially imposed limit currently set by the test equipment at DLI.

## Mounting Information

PCB ground pattern length and width can be 0.002-0.003 inches larger than filter footprint. Dimensions of filter launch and PCB launch pattern should be closely matched. It is suggested that PCB ground metal be pulled back from RF I/O trace to account for component alignment tolerance. Ground via depth and spacing should be set so as not to create any resonances at the frequency of operation.

Reference SMT Filter Mounting application note for additional mounting information.

Individual footprint diagrams of all Filters are available upon request from the DLI Sales Office.

**Typical Weight:** <0.3 grams

**Typical Area:** <0.1 in<sup>2</sup>

**Typical Volume:** <0.01in<sup>3</sup>

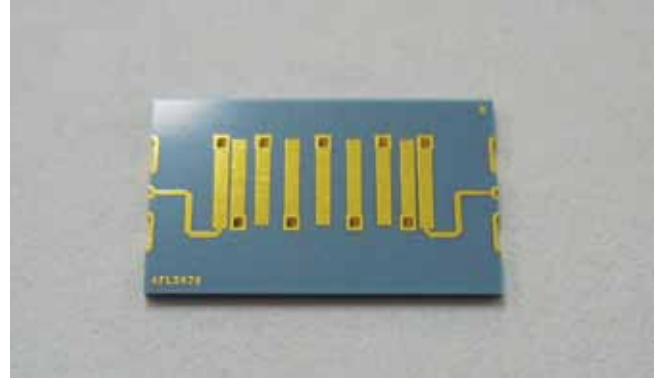

Interdigital

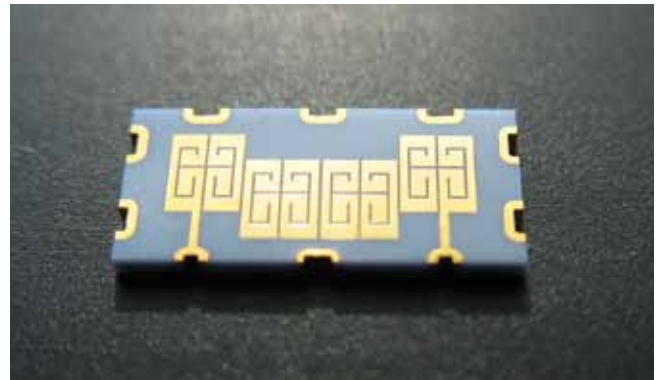

Dual Mode

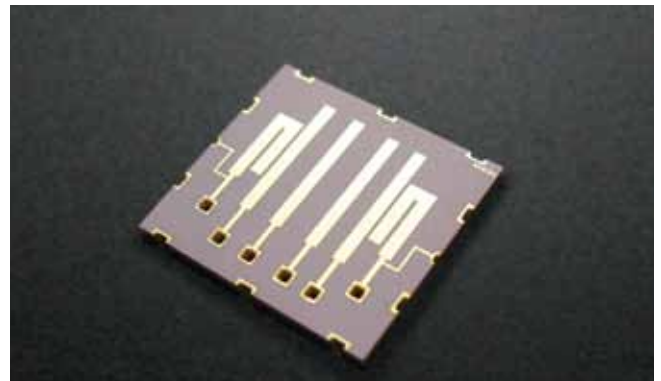

Comblines



Hairpin

# Thin Film - Ceramic Filters

DLI has expanded its filter capability beyond microstrip bandpass designs. Notch filters, lowpass and highpass filters, ceramic cavity filters, and various other filter types are now available. All filters employ DLI's high-K ceramics which allow for great size reduction and unbelievable temperature stability compared to alumina and PWB materials. Solder surface mount and chip and wire filters are all possible.

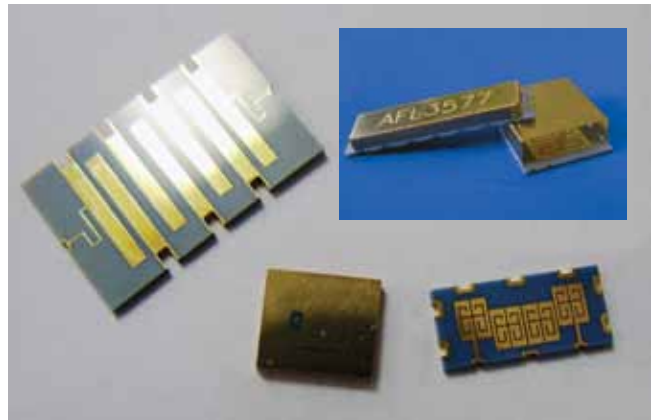

## 4GHz Notch Filter

- >20dB attenuation at 4GHz
- >Low loss in passband regions: 1.5dB
- >Small size: .25 x .196 x .02 inches
- >Solder surface mount device
- >Picture below

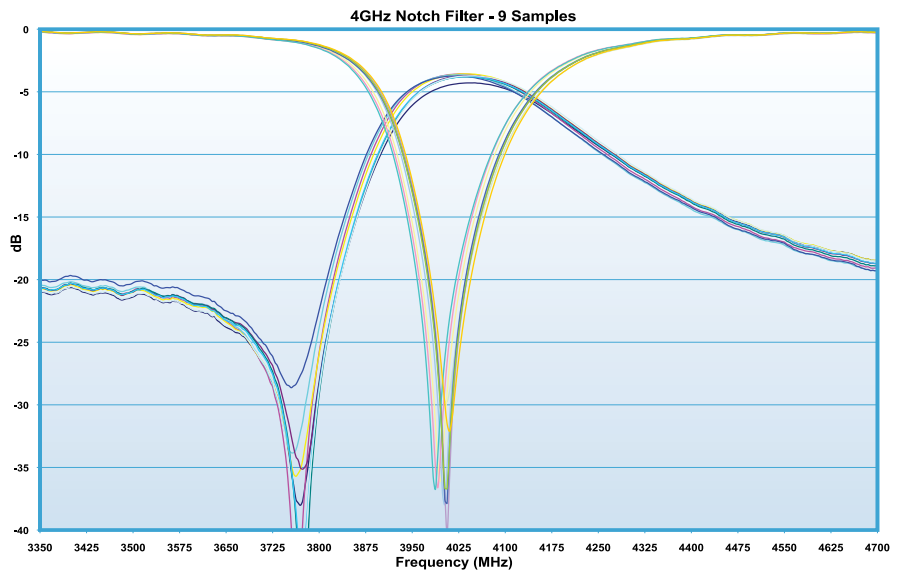
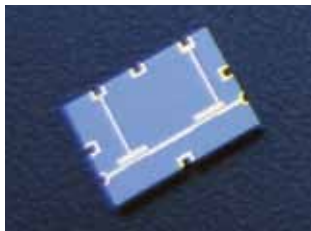

Lowpass Filter - 3 Samples

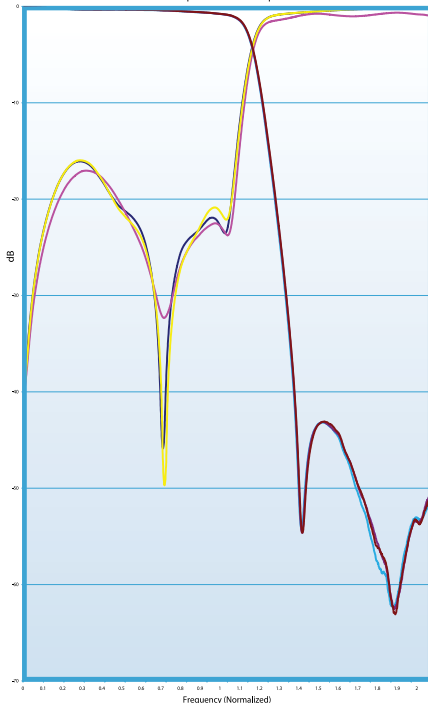

## Typical Lowpass Filter

- >Low loss in passband: 1.0dB
- >40dB attenuation in stopband
- >Typical size: .4 x .25 x .015 inches
- >Chip and wire filter [mounted on PCB with epoxy]
- >Devices scalable from L to Ka band

**NOTE:** See our website for more details.

## Typical Cavity Filter

- >Ceramic cavity filter design on CF ceramic
- >Low loss in passband: 3.5dB typical
- >Typical size: .75 x .18 x .03 inches
- >Devices scalable from X to Ku band
- >Bandwidth 1 to 3%

Cavity Filter - 5 Samples

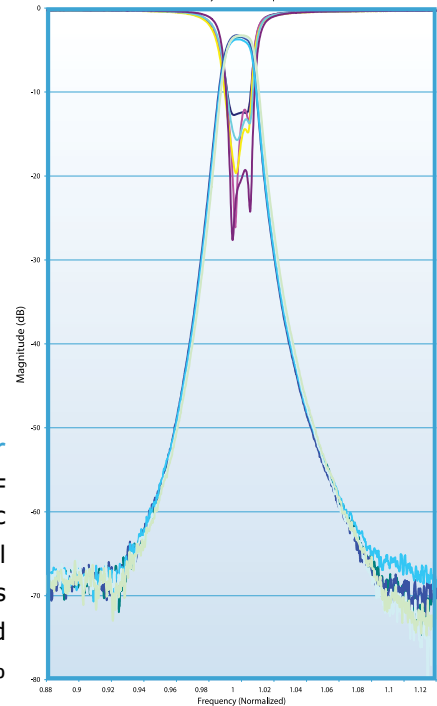

# Thin Film - Ceramic Filter Packaging and Shielding

Exceptional performance demands rigorous engineering, both of the component and of its interaction with the system. The design of the filter's shielding is a crucial element for achieving laboratory-grade performance outside of the laboratory and assuring smooth integration with the system. Shielding protects the filter from interference and creates a precisely controlled micro-environment for optimal performance. There are three packaging options available for RF shielding:



**Filter with sheet metal cover**

These covers are attached using epoxy; the cured assemblies offer a small and sturdy surface mount package that can integrate multiple filters in one pc. The overall height of the package is typically 0.1 inch. A second option for shielding is the attachment of an integral metal cover to the filter. Sheet metal covers are compatible with both solder surface mount and chip and wire filter applications.

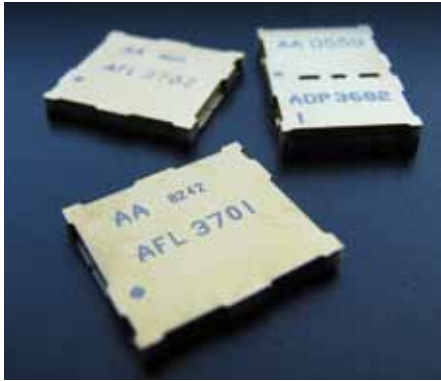

**Filter with printed wire board cover**

Printed wire board (PWB) covers are one solution offered by DLI. This style of cover offers excellent RF shielding for solder surface mount applications. Additionally, PWB covered components are extremely resistant to high shock and vibration environments.

Typically, this style of cover has tabs that fit into the ground vias along the perimeter of the part and a high-temperature solder is used for the assembly. Covers can be recessed to expose the I/O contact pad for chip and wire filters to allow wire-bonding. The I/O contact pad is not plated with a solderable metal scheme to facilitate reliable wire bonding. The overall assembly height can vary from 0.07 to 0.1 inches.

The third option leaves packaging up to the customer. Either the next level of assembly provides the RF shielding for the filter or the customer can have their own cover integrated. DLI's engineering team can provide recommendations for housing dimensions, leveraging years of expertise to ensure successful design integration.

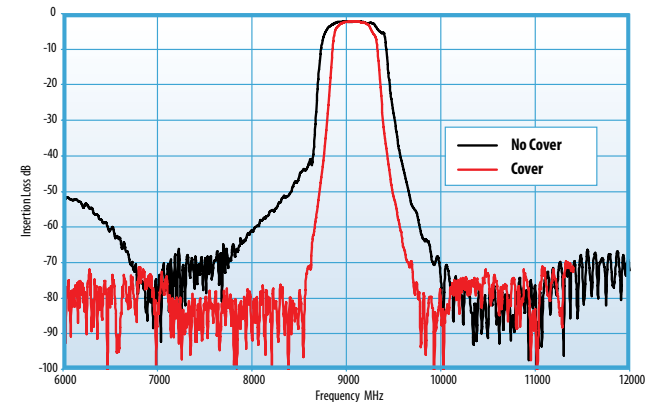

**High K substrate provides Higher Field Confinement – 9 GHz Filter (30 mil CF with and without cover).**

If the customer provides their own shielding for the filter, it is very important that DLI engineering knows the channel width and cover height that will enclose the device. These dimensions will be taken into account during design and test to ensure that the part will work in its next level of assembly.

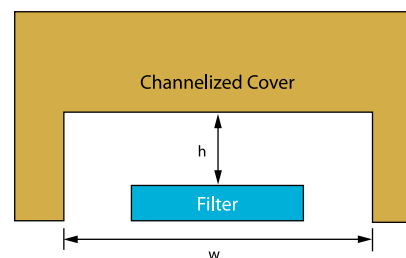

**Housing dimensions critically affect performance**

## Solder Stop

Prevents solder from wicking through vias onto critical features during SMT processing

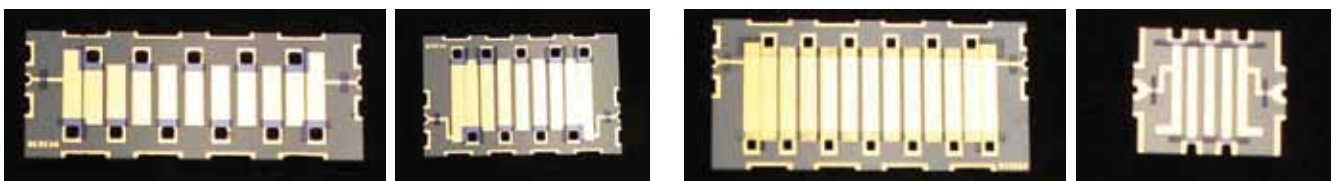

# Thin Film - Ceramic Filter Mounting

DLI offers metallization schemes compatible for both chip and wire filters, and solder-surface mount filters. The correct metal scheme will be employed to ensure reliable connectivity depending on the desired mounting method. Custom metallization schemes are also available. Please consult the factory for more details.

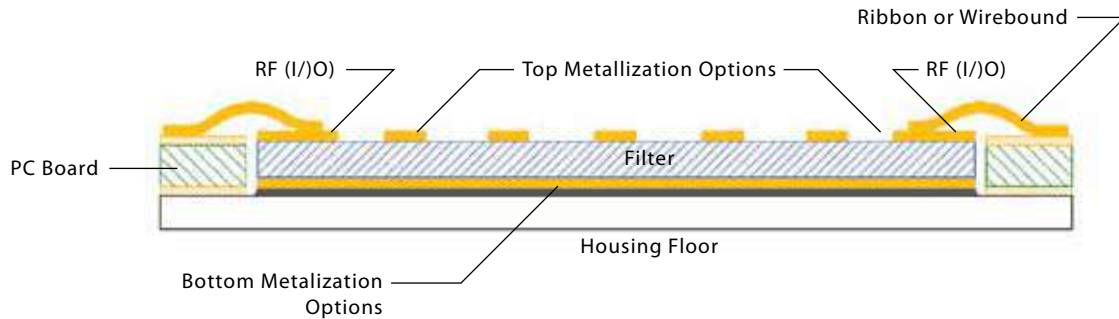

The above illustration demonstrates the mounting of a typical chip and wire filter. The circuit is relieved to accommodate the filter. The bottom surface of the part is attached directly to the system ground plane using conductive epoxy. Wire or ribbon bonds are launched from the circuit to the filter I/O pad. In a typical application a channelized housing would sit over the filter to provide adequate RF shielding.

Surface mounting techniques typically rely on a solder bond between the bottom conductor of the component and the ground conductor of the circuit board. The I/O connection is realized through edge castellations on the filter which mate with contact pads when the component is mounted on the board. Note the use of multiple ground vias between the component and the system ground plane to ensure optimal performance. Solder surface mount designs are custom matched to the specific board material on which they will be placed. In a typical application, a channelized housing would be placed over the filter to provide RF shielding.

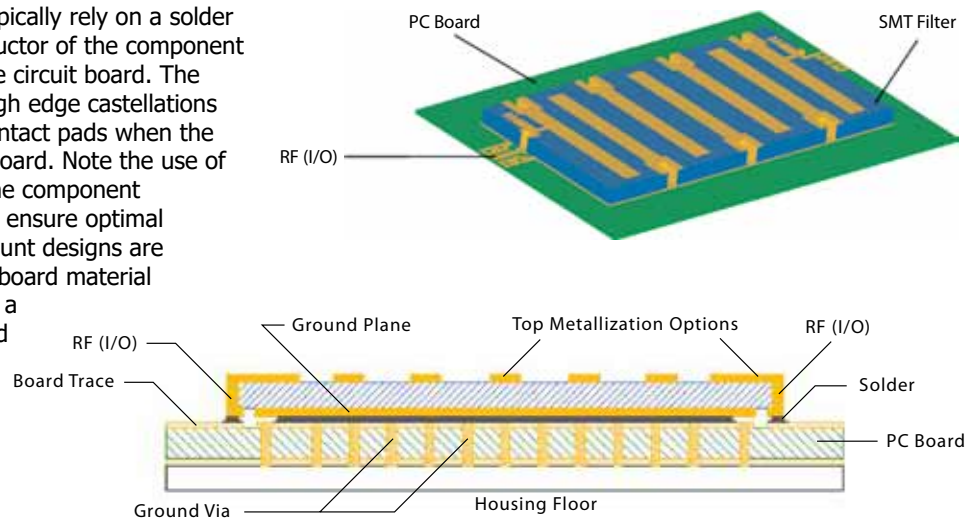

# Thin Film - Ceramic Filter Temperature Stability

The primary ceramics used in DLI filter designs are CF [K=23] and CG [K=67]. Both of these materials exhibit extreme temperature stability across a wide range of frequencies. So regardless of the filter operating frequency, no guard band needs to be designed into the device to meet a demanding temperature requirement. CF and CG

also do not out gas, do not exhibit signs of aging, and have been exposed to a mega-rad of total radiation dosage with no degradation in performance. The filters will perform the same from outer space to the desert. The graphs below demonstrate the extreme stability of DLI custom ceramic devices.

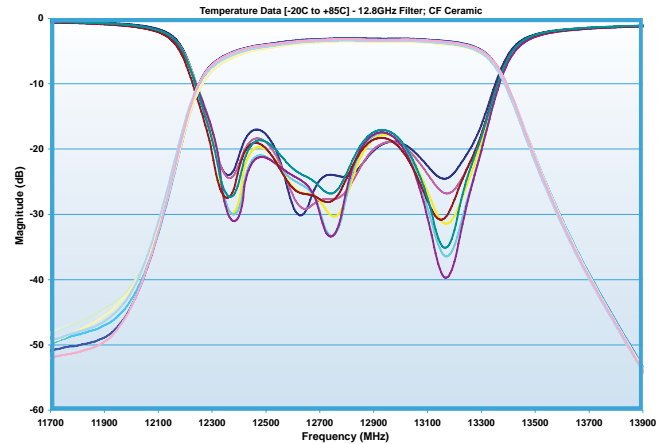
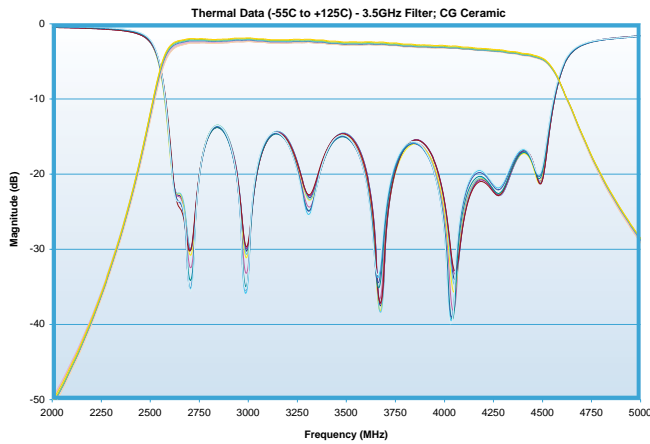

## Stability Over Temperature (-60° to +125° C)

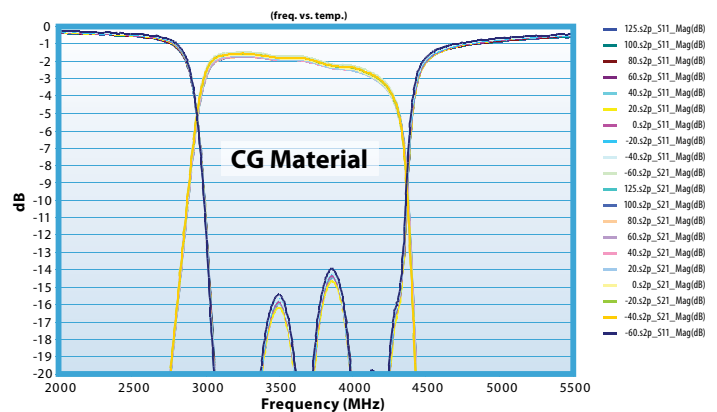
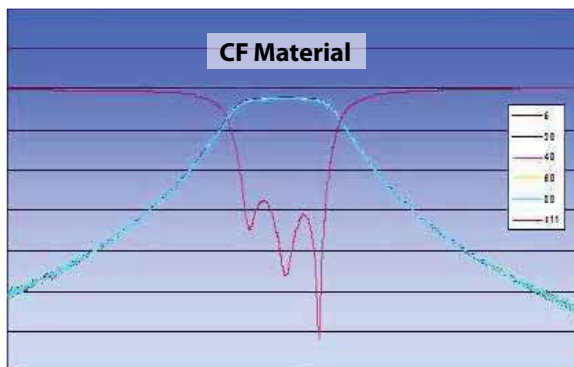
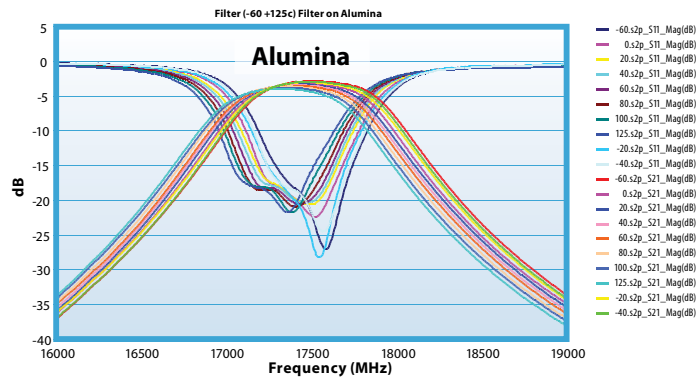

# Thin Film - Surface Mount Lowpass Filter Series

## Description

DLI introduces its new high frequency surface mountable catalog lowpass filters. These LPF's incorporate DLI's high dielectric ceramic materials which provide small size and minimal performance variation over temperature. The catalog LPF's are offered in a variety of frequency bands, which offers a drop in solution for high frequency attenuation.



## Features

- Small Size
- SMD device
- Fully Shielded Component
- Frequency Stable over Temp.
- Excellent Repeatability
- Operating Temp: -55°C to +125°C
- Characteristic Impedance: 50Ω
- 100% Tested and Inspected

Specification	Part Number						
	L065XG9S	L095XG9S	L117XH4S	L128XH4S	L157XG3S	L204XF4S	L254XF3S
<b>3 dB Cutoff</b>	6.5 GHz	9.5 GHz	11.7 GHz	12.8 GHz	15.7 GHz	20.4 GHz	25.4 GHz
<b>Passband</b>	DC - 6 GHz	DC - 9 GHz	DC - 11 GHz	DC - 12 GHz	DC - 15 GHz	DC - 20 GHz	DC - 25 GHz
<b>Max Insertion Loss in Passband</b>	1.3 dB	1.3 dB	1 dB	1.2 dB	2.2 dB	1.8 dB	1.4 dB
<b>Min VSWR in Passband</b>	1.22:1	1.12:1	1.43:1	1.38:1	1.3:1	1.43:1	1.3:1
<b>Min Rejection</b>	7.9 - 22.4 GHz (35 dB)	11.5 - 32 GHz (30 dB)	17.6 - 30 GHz (40 dB)	18.8 - 32 GHz (40 dB)	19.9 - 32.2 GHz (40 dB)	23 - 43 GHz (30 dB)	29 - 50 GHz (30 dB)
<b>Usable temp. Range</b>	-55 to +125°C						
<b>Length - Inches (mm)</b>	0.220 (5.58)	0.220 (5.58)	0.220 (5.58)	0.220 (5.58)	0.220 (5.58)	0.220 (5.58)	0.220 (5.58)
<b>Width - Inches (mm)</b>	0.180 (4.57)	0.140 (3.56)	0.140 (3.56)	0.140 (3.56)	0.140 (3.56)	0.140 (3.56)	0.140 (3.56)
<b>Height - Inches (mm)</b>	0.103 (2.62)	0.103 (2.62)	0.103 (2.62)	0.103 (2.62)	0.103 (2.62)	0.078 (1.98)	0.078 (1.98)

## Typical Measured Performance

**L065XG9S - 6.5 GHz**

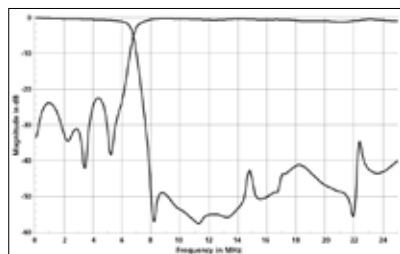

**L095XG9S - 9.5 GHz**

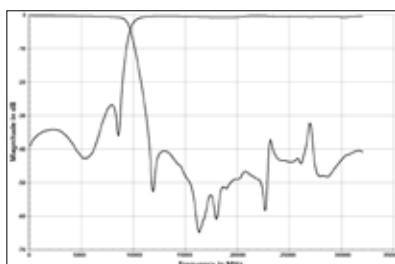

**L117XH4S - 11.7 GHz**

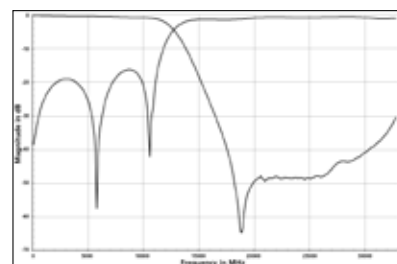

**L128XH4S - 12.8 GHz**

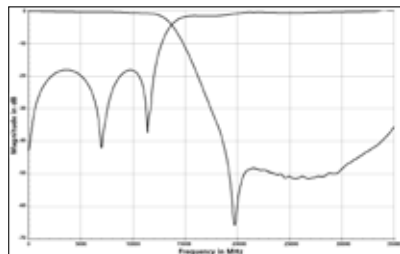

**L157XG3S - 15.7 GHz**

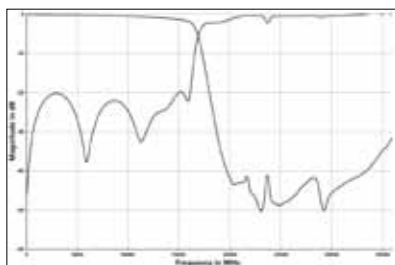

**L204XF4S - 20.4 GHz**

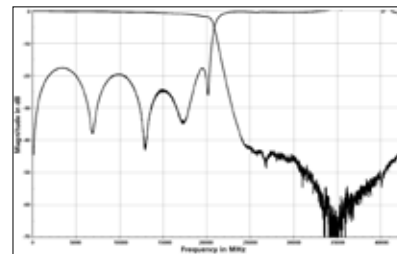

**L254XF3S - 25.4 GHz**

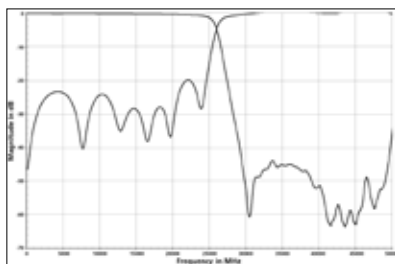

# Thin Film - 2 to 18 GHz Bandpass Filter Series

## Description

Utilizing DLI's high permittivity, NP0 ceramics allow for small size, temperature stable performance over frequency and high reliability in environmentally challenging conditions. This series of bandpass filters was designed to span the popular 2-18 GHz frequency range. The compact size and surface mount attachment allow for low cost of manufacturing without sacrificing performance and repeatability. Designed for use on PCB 8-12 mils thick with a permittivity of 3.0-3.8.

## Features

- Small Size • Fully Shielded Component
- Frequency Stable over Temperature

## Applications

- C, X and Ku Band • Satellite communications • Satellite TV
- Weather and Radar • Radar and Military communications



Specification	Part number					
	B028RF2S	B033ND5S	B056RC4S	B096QC2S	B148QF0S	
Center Frequency	3 GHz	3.5 GHz	6 GHz	10 GHz	15 GHz	
Passband	2 to 4 GHz	3.1 to 3.5 GHz	4 to 8 GHz	8 to 12 GHz	12 to 18 GHz	
Insertion Loss (@Fc)	@ 25°C	2.5 dB	2.0 dB	3.0 dB	2.5 dB	3.1 dB
	-40 to +85°C	3.0 dB	3.2 dB	3.5 dB	3.0 dB	3.6 dB
VSWR - 50W System	1.63:1	2.00:1	1.5:1	2.0:1	1.63:1	
	2 to 4 GHz	3.1 to 3.5 GHz	4 to 8 GHz	8 to 12 GHz	12 to 18 GHz	
Rejection	dc to 1.25 GHz (40 dB)	dc to 2.6 GHz (30 dB)	dc to 3 GHz (40 dB)	dc to 6 GHz (40 dB)	dc to 7.6 GHz (40 dB)	
	4.85 to 6 GHz (40 dB)	4 to 6 GHz (40 dB)	9.5 to 12 GHz (40 dB)	14 to 18 GHz (40 dB)	22.5 to 25 GHz (30 dB)	
Usable Temperature Range	-55 to +125°C					
Length - Inches (mm)	0.450 (11.43)	0.393 (9.98)	0.450 (11.43)	0.400 (10.86)	0.550 (13.97)	
Width - Inches (mm)	0.400 (10.16)	0.353 (8.97)	0.230 (5.84)	0.180 (4.57)	0.150 (3.81)	
Height - Inches (mm)	0.113 (2.87)	0.128 (3.25)	0.100 (2.54)	0.100 (2.54)	0.098 (2.49)	

## Typical Performance

B028RF2S - 2 to 4 GHz

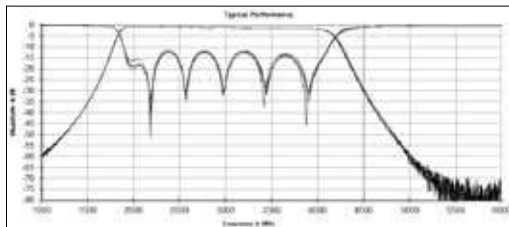

B033ND5S - 3.1 to 3.5 GHz

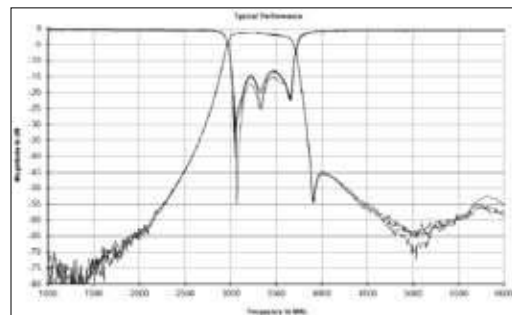

B056RC4S - 4 to 8 GHz

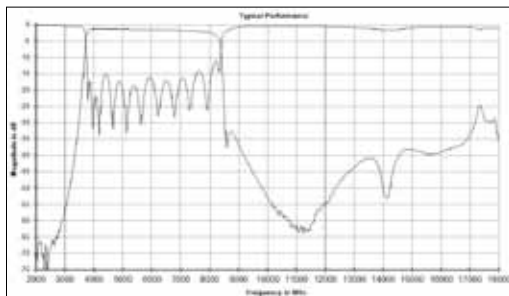

B096QC2S - 8 to 12 GHz

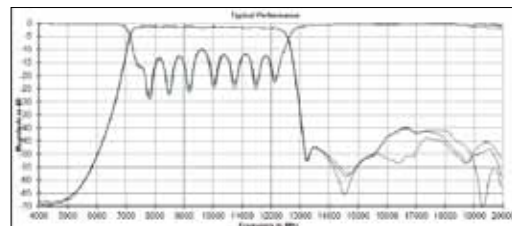

B148QF0S - 12 to 18 GHz

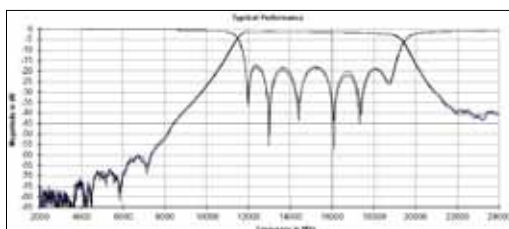



# Thin Film - Wilkinson Power Divider

## Description - Part number PDW05758

DLI introduces its new high frequency surface mountable Wilkinson Power Divider. The power divider utilizes DLI's high dielectric ceramic material which provides small size and minimal performance variation over temperature. The compact size, broad band performance and ease of integration make this power divider ideal anywhere board space is of a premium and quality signal splitting or combining is required.

### Features

- Broad Band 6 to 18 GHz Performance
- 0.7dB Typical Insertion Loss
- 20dB Typical Isolation and Return Loss
- Excellent Phase and Amplitude Balance
- Compact Solder Surface Mount Package

### Electrical Specification

Frequency Range (GHz)	6 to 18
Nominal Power Splitting (dB)	3.0 (typical)
Nominal Phase Shift (degrees)	0.0 (typical)
Amplitude Balance (dB)	±0.025 max.
Phase Balance (degrees)	±3.0 (max.)
Excess Insertion Loss (dB)	0.7 (typical)
Return Loss (dB)	20 (typical)
Isolation (dB)	20 (typical)
Input Power as a Splitter (W) <sup>2</sup>	5 (max.)

- 1) Electrical Specifications at 25°C; Over Temperature Performance TBD.
- 2) Load VSWR not to Exceed 1.20 : 1.00; Base Temperature not to Exceed 85°C.

### Recommended PCB Layout Dimensions

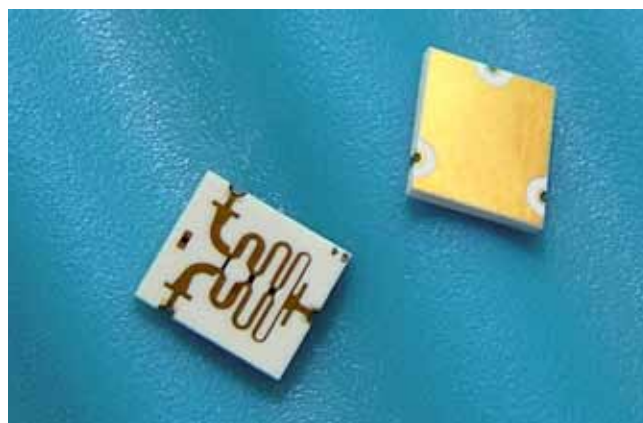
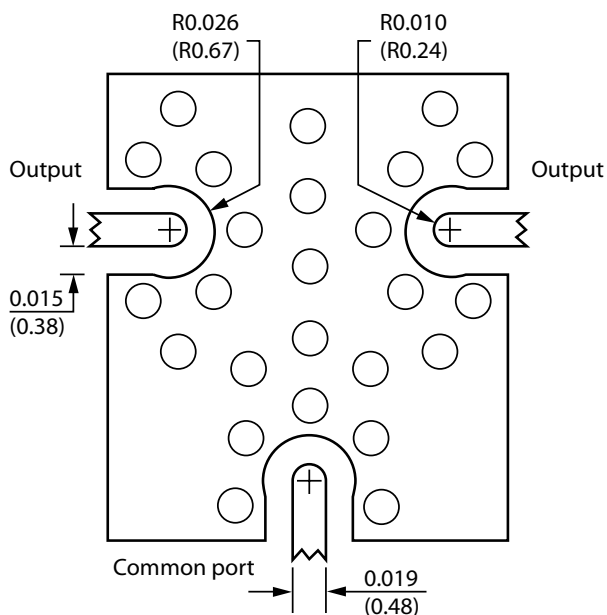

### Physical Dimensions

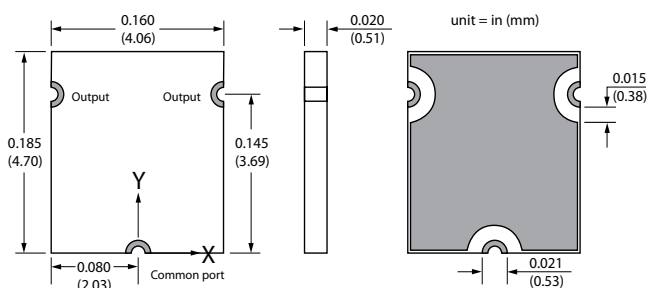

Shaded areas are solderable metal

### Typical Measured Return Loss

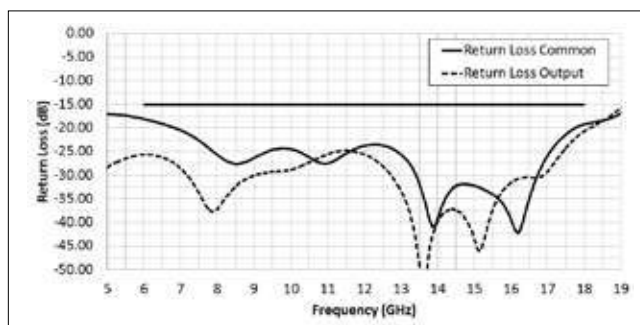

### Typical Measured Isolation and Insertion Loss

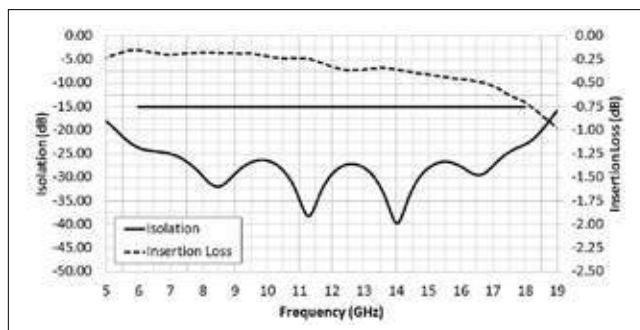

# Thin Film - Symmetric Dual Mode Resonator Filter

## Description

- High selectivity, (>-60 dB rejection in 1% bandwidth distance from center)
- High Q (low loss)
- Low loss
- Temperature stable
- 16 pole design with integrated trap to suppress harmonics

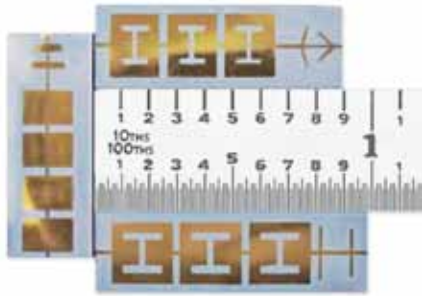

## 6.5 GHz Symmetric Dual Mode Bandpass Filter

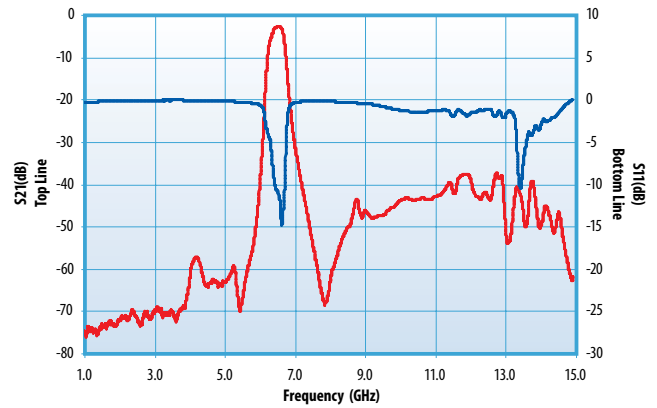

# Thin Film - 10GHz 4 Pole Band Pass with Bandstop Filter

Size: 0.9 x 0.2 x .02 Inches

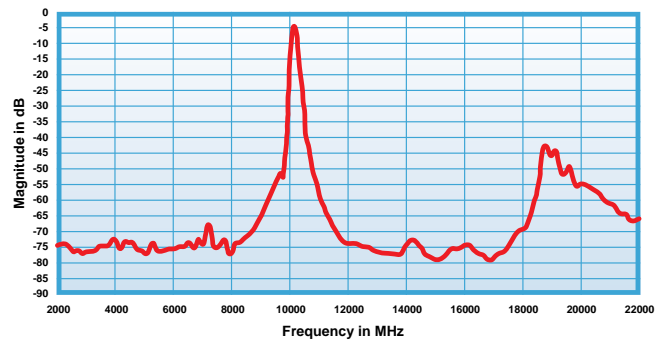

# Thin Film - 20 GHz 8 Pole SMT Filter

Size: 420 x 90 x 15 mils

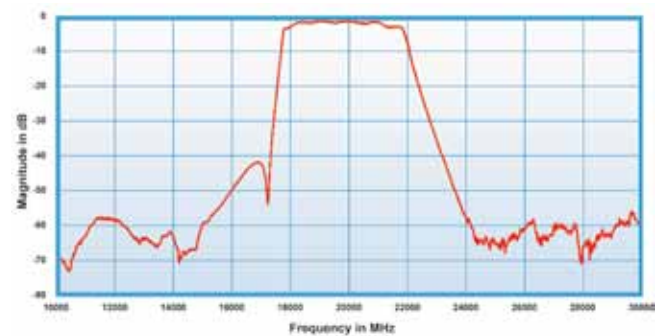

# Thin Film - 36 GHz Filter Repeatability

70 Samples from Multiple Substrates and Material Lots

10 mil CF (K23) Material

- Highly repeatable performance
- Excellent temperature stability

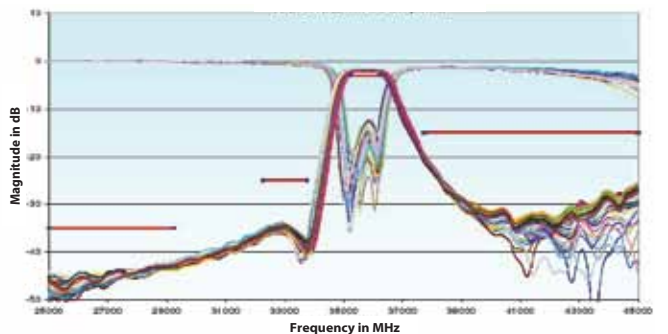

# Thin Film - GPS Filters

DLI introduced a family of GPS components that includes two bandpass filters, two diplexers, and a notch filter. The bandpass filters and diplexer pass both L1 and L2 frequency bands. The notch filter attenuates the L1 frequency band.

Two different versions of the diplexer have been designed and manufactured. The first version has higher insertion loss but better rejection due to a narrow bandwidth. The bandwidth was widened on the second version to reduce the insertion loss at the cost of eroding the rejection skirts. Data for the second version is presented below.

The bandpass filters and diplexer incorporate DLI's new printed wire board cover technology. The PWB cover provides RF shielding and reduces the possibility of energy coupling from the filters to other components in the circuit.

The notch filter incorporates an integral metal cover for RF shielding.

All components are solder surface mount compatible and would make a nice temperature stable drop-in for any GPS application.

The data here represents typical performance for all of the devices.

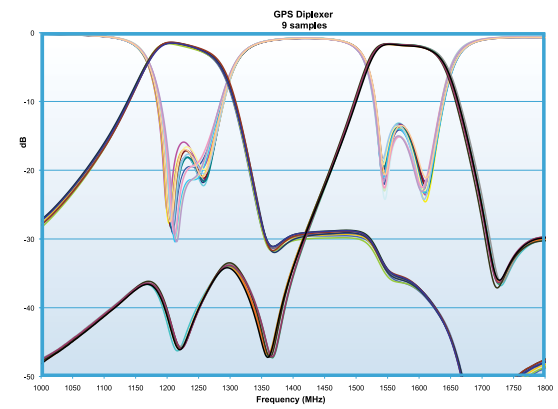
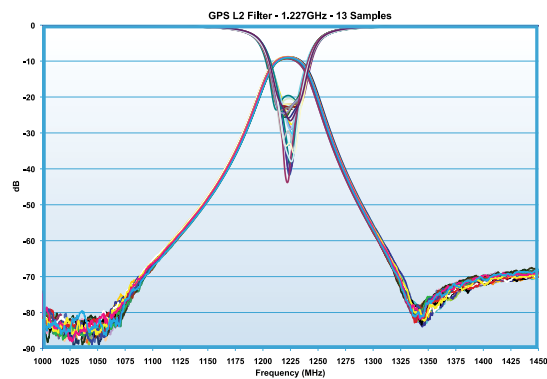
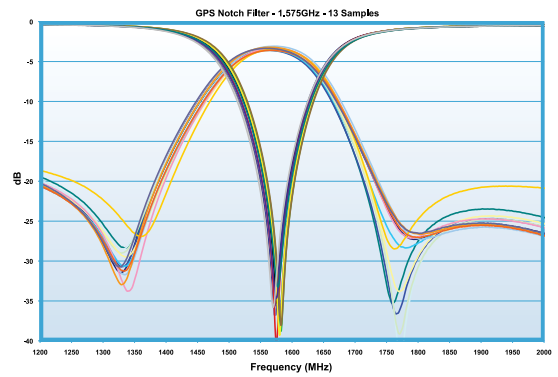
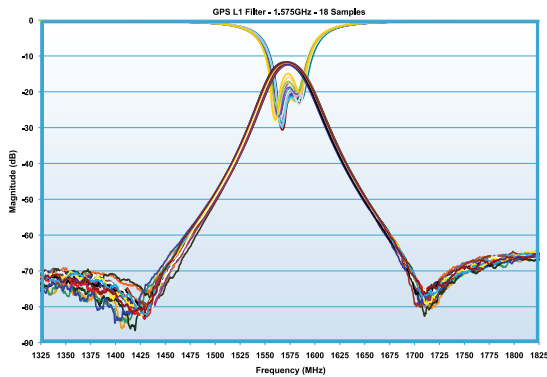

# Thin Film - 9.7 GHz End Coupled Filter

## Features

- 7-Pole End Coupled Filter
- 4% Bandwidth (400 MHz)
- Insertion Loss <2.7 dB
- Size (1.1" x 0.1" x 0.03") **but...**
- Typical cover height is 6X material thickness –
- between 75 and 100 mils

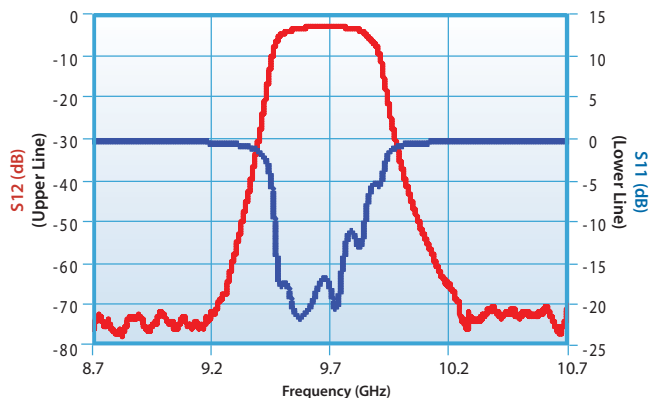

# Thin Film - High-K Ceramic Substrates and Plates

High K substrates are used for circuit miniaturization.

DLI offers complete fabrication services!

## Case Sizes and Tolerances

For custom sizes please contact the sales office.

Case Size (Inches)	Length (Inches)	Width (Inches)	Tolerance	
			Plates (H) ± (Inches)	Substrates (S) ± (Inches)
10	1.000	1.000	Substrates Only	.002
15	1.000	1.500	.050	.002
20	2.000	2.000	.050	.002
25	2.500	2.500	.050	.002
30	3.000	3.000	.050	.002
40	4.000	4.000	.050	.002



## Material Specifications

Material Code	Relative $\epsilon_r^*$ @ 5 GHz	TCCTLoss ppm/°C	Coefficient of Tangent* % Max	Thermal Thermal Expansion ppm/°K	Conductivity W/m-°K
QZ	3.82 (@ 1MHz)	Fused Quartz	0.0015 (@ 1MHz) 0.033 (@ 24 GHz)	0.55	1.28
AG	8.85 ± 0.35 (@ 1MHz)	Aluminum Nitride	0.10	4.6	140-180
PI	9.9 ± 0.15 (@ 1MHz)	Alumina 99.6%	0.01	6.5 - 7.5	27
PG	12.5 ± 0.5	P22 ± 30	0.02	7.6	—
AH	20 ± 0.5	P90 ± 20	0.02	9.6	1.56
NA	23 ± 1	N30 ± 15	0.03	10.1	1.56
CF	25 ± 2	0 ± 15	0.15	9.0	1.56
CD	38 ± 1	N20 ± 15	0.04	5.8	1.59
CG	67 ± 3	0 ± 30	0.10	9.0	1.59
NR	152 ± 5	N1500 ± 500	0.06	10.0	2.72

\*Unless otherwise specified K dielectric measurement at approximately 5 GHz. †For the temperature range -55 to 125°C.

## Surface Finish

Code	Roughness $R_a$	Material Process
X	>50 $\mu$ in.	As-Fired
Y	20 $\mu$ in.	Machined
Z	<5 $\mu$ in.	Polished
S	Special - Drawing req'd	

## Metallization

Code	Description
X	No Metallization
M	300 Angstroms TiW, 100 $\mu$ in. min. Au
N	300 Angstroms TiW, 50 $\mu$ in. min. NiV, 100 $\mu$ in. min. Au
P	75 $\mu$ in. min. Nickel, 100 $\mu$ in. min. Au
L	Top 50 Ohms/sq. TaN, 300 Angstroms TiW, 100 $\mu$ in. min Au. Bottom Side 300 Angstroms TiW, 100 $\mu$ in. min. Au
E	Metallized and etched per Customer drawing
T	300 Angstroms min. TiW, 50 $\mu$ in. min. NiV, 300 $\mu$ in. min. Au-Sn
D	SPECIAL, Customer Drawing Required!

## Screening Options

Test Code	Test/Inspection	Sample Size	Description
X	Visual Mechanical	100%	Verify that the required area is available and continuous (Broken corners allowable).
K	Visual Mechanical	100%	Verify that the required area is available and continuous (Broken corners allowable).
	Kent Test	10% of lot	K and Loss.
D	Customer Defined		Customer Drawing Required!

## Part Number Identification

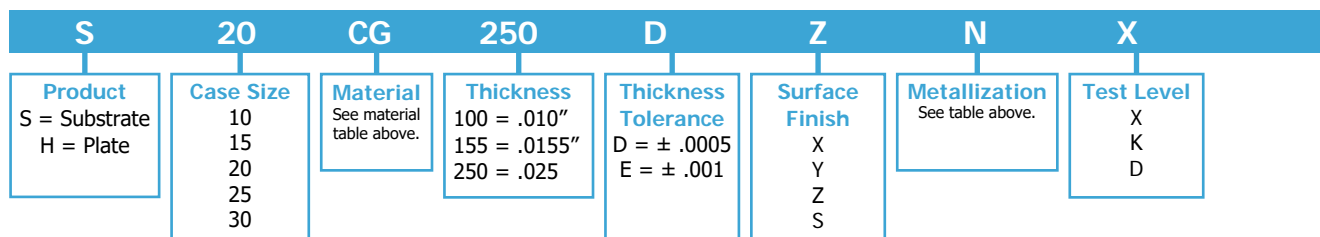

**Thickness Code.** A three digit code representing the thickness in mils.  
Examples: Code 100 = .010", Code 155 = .0155", Code 250 = .025"  
Please consult with an applications engineer for thicknesses < .010"

**Thickness Tolerance Codes**  
D = ± .0005 – Machined or Polished  
E = ± .001 – Standard

# Thin Film - Ceramic Resonators

DLI has a family of patent pending high-Q ceramic cavity resonators. They provide an ideal solution for high performance, low-cost microwave, or millimeter wave oscillators. The devices are fully shielded and designed on our temperature stable, high dielectric constant ceramics.

Frequencies of resonator designs range from <1.0 to >67GHz. Designs can be customized for either solder-surface mount or chip and wire applications. High reliability thin film gold metallization is employed and frequency tolerances as low as 0.1% are attainable.

DLI has developed an equivalent circuit modeling tool for cavity resonators. The tool enables optimization of resonator based oscillator designs and constrains circuit element values to realizable combinations. Three models are shown below, at 8GHz, using CF ceramic, one using FS, and one using CG.

Please consult DLI Applications Engineering for a copy of the modeling tool.

CF (design1)

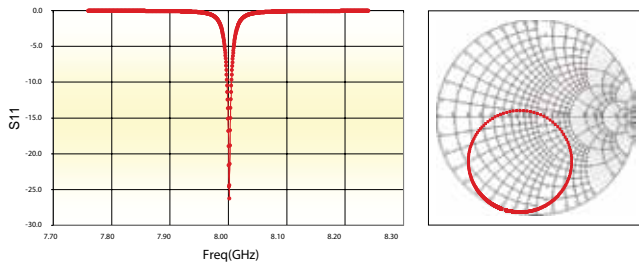

CG

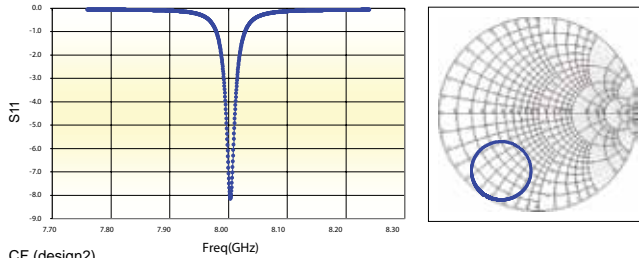

CF (design2)

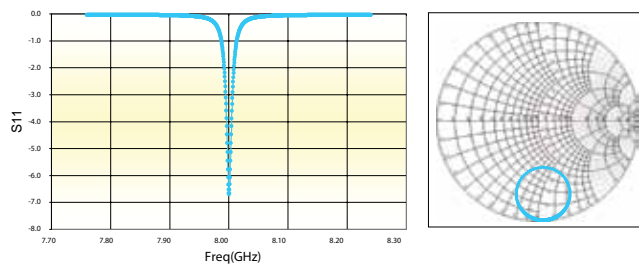

FS

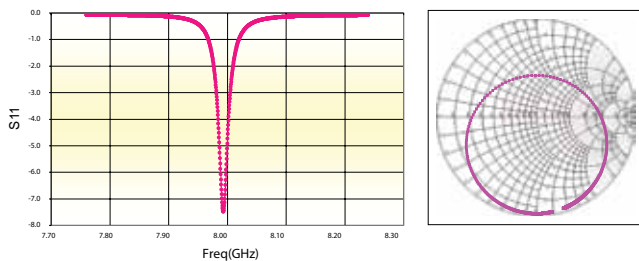

DLI resonators are direct in frequency. So in addition to all of the other benefits no multiplication is required as there would be in other technologies. As a solid block of ceramic they are also non microphonic  
**.....Imagine the possibilities!**



6.8GHz oscillator

## Types of Applications

### Systems

#### INSTRUMENTATION

#### AUTOMOTIVE

- RADAR** • Ground-based • Avionics/Missile • Shipboard
- COMMUNICATIONS** • Base Stations • WLAN, WLL • SONET/SDH
- MILITARY** • RFID • ECM/ECCM/EW • Tx/Rx • Man Pack Radio
- Aerospace • Intelligent Munitions

### Circuits

- Microwave and Millimeter-Wave Oscillators
- Fundamental Fixed Frequency Oscillators - Ultra-low Phase Noise (former solution: expensive DRO's and multiplied-up crystal or SAW based device with decreased performance)
- Narrow-Band Tunable VCO or Phase Locked Oscillators (typically  $\pm 3\%$  tuning) (former solution: varactor tuned expensive DRO)
- Integration of high performance Oscillators directly on the system motherboard without the expense and complexity of subassemblies, housing and labor intensive operations typical of former solutions.
- Narrow bandwidth low loss filters (former solution: low loss SAW devices with frequency limitation and poor performance)

Two port resonators can also be realized for varactor-tuned oscillator and feedback oscillator applications. The devices can also be implemented as one-pole bandpass filters. These are fully shielded and designed on temperature stable ceramics like the one port resonators. Below is required information for a two port resonator design and measured test data of a two port resonator at 24GHz.

Electrical Specification		General Information	
Resonant Frequency	Fc = ____GHz Tolerance: ____%	Resonator Application	Varactor - Tuned OSC Feedback OSC Filter
Doubly Loaded Q	QL = ____	Size Restriction	Max width: ____ Max length: ____ Max thickness: ____
Maximum Insertion Loss At Fc	IL = ____dB	Assembly Type	Solder Surface Mount Epoxy Attach

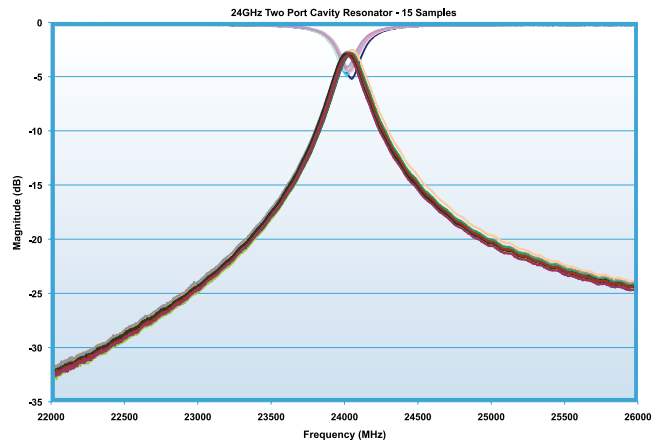

# Thin Film - Single Frequency Cavity Resonator

The table summarizes the characteristics of selected standard resonators to illustrate the primary resonator design variables. The primary variables are frequency of resonance, cavity material dielectric constant and length-by-width dimensions. The interaction of these variables is illustrated in the resonator size charts on Page 62. The loaded Q of the resonators is effected by the coupling coefficient (denoted in the tables in terms of return loss), the material choice (dielectric constant), and by material thickness. Generally, resonators made from thick, low dielectric constant materials are capable of the highest loaded Q's. For reference, when a resonator has a coupling coefficient of 1.0, it will exhibit an excellent return loss at the resonant frequency and the unloaded Q will be 2

times the loaded Q value. The desired level of resonator coupling varies with individual circuit requirements such as varactor frequency tuning or transistor negative resistance value. The unloaded Q's of the cases shown range up to 2,000, clearly a new standard for a component compatible with automated assembly. In contrast to other "high Q" microwave resonators, DLI's cavity resonator is completely self contained. Large, expensive housings are not needed. Its loaded Q and resonant frequency can be directly measured using RF coplanar probe technology. Thus, ambiguities of special test fixtures and components which are not appropriate to the product realization are eliminated from part evaluation.

## Representative Sampling of Resonator Characteristics

Resonant Frequency (GHz) *1	Material	Temperature Coefficient of Frequency *2 (Typical 9PPM/°C)	Return Loss @ Resonance Typical (dB)	Loaded Q Typical (50 OHMS)	Dimensions L x W x T	
					mm	Inches
3.2	CG	+8.8	-22	290	8.1 x 8.1 x 3.0	0.32 x 0.32 x 0.12
5.0	CF	-2.3	-12	550	8.1 x 8.1 x 3.0	0.36 x 0.36 x 0.12
5.0	CG	+8.8	-12	360	5.1 x 5.1 x 3.0	0.20 x 0.20 x 0.12
5.0	FS	-7.3	-12	1000	21.8 x 21.8 x 3.8	0.86 x 0.86 x 0.15
6.8	FS	-7.3	-9	1050	15.7 x 15.7 x 3.0	0.62 x 0.62 x 0.12
8.2	CF	-2.13	-25	250	5.3 x 5.3 x 0.8	0.21 x 0.21 x 0.03
9.95	CF	-2.3	-11	300	5.6 x 4.3 x 0.8	0.22 x 0.17 x 0.03
12.8	CF	-2.3	-7	350	3.8 x 3.6 x 0.8	0.15 x 0.14 x 0.03
18.65	FS	-7.3	-25	400	6.1 x 5.6 x 1.0	0.24 x 0.22 x 0.04
24.0	CF	-2.3	-12	480	21.8 x 21.8 x 3.8	0.86 x 0.86 x 0.15
24.0	FS	-7.3	-12	1000	4.6 x 4.6 x 3.0	0.18 x 0.18 x 0.12
26.5	FS	-7.3	-20	325	4.2 x 4.2 x 0.5	0.16 x 0.16 x 0.02
40	FS	-7.3	-18	445	2.7 x 2.7 x 0.5	0.10 x 0.10 x 0.02
50	FS	-7.3	-17	400	2.2 x 2.2 x 0.5	0.08 x 0.08 x 0.02
67	FS	-7.3	-12	600	1.6 x 1.6 x 1.0	0.06 x 0.06 x 0.04

\*1 Frequency Tolerance 0.1~ 1% \*2 Over the range -60°C to + 125°C

The equivalent circuit of the Single Frequency Cavity Resonator (SFCR) near its lowest resonant frequency is shown below. The lowest resonant mode is typically employed in oscillator and filter designs. The element values are shown for a 9.95 GHz SFCR. The resonant frequency is set by the parallel combination of Cp and Lp, and the finite unloaded Q by R. The series capacitance Cs connects the resonator L-C to the input pad, thus setting the coupling between the external circuit and the frequency controlling L-C resonator. The capacitance Csh is a stray capacitance between the input pad and ground. All of these network elements have excellent repeatability providing tight control

over resonant frequency, coupling and input impedance. The structure also provides an integrated DC blocking function, thus eliminating a tolerance sensitive element from the bill of materials. For wide bandwidth circuit modeling, S-Parameters are recommended. S-Parameters are available for downloading from our website ([www.dilabs.com](http://www.dilabs.com)). The resonators are readily customized for frequency, coupling, Q, tunability and assembly requirements.

The Graph below depicts typical Single Frequency Cavity Resonator frequency stability versus temperature for DLI standard dielectric materials.

## Equivalent Circuit of a 9.95 GHz SFCR

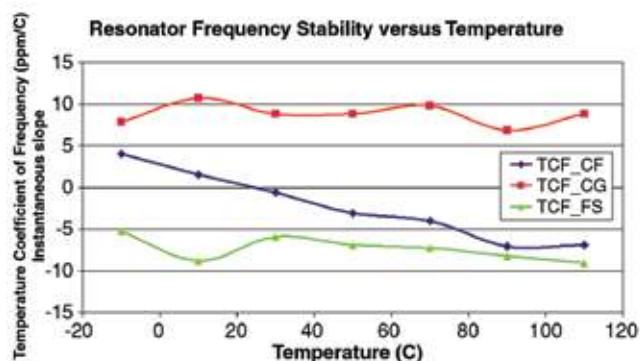
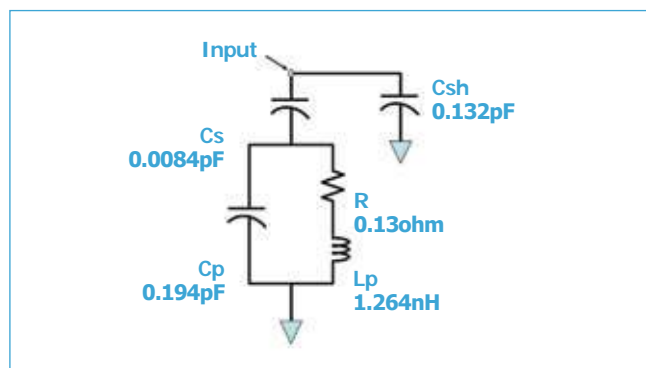

# Thin Film - Single Frequency Cavity Resonator

## Standard Frequencies for SFCR

DLI has established a series of standard specific frequency resonators (EAR 99) which have the ability to be laser trimmed down in frequency by approximately 2% of the actual resonant frequency. The resonators incorporate lithography defined 'snake eyes' that the laser can recognize as a starting point to trim through the gold. Frequencies above and below this range of standard frequencies are obtainable. Please contact DLI Applications Engineering for more details.

Resonant Frequency (MHz)	Tunable Range (MHz)	Resonant Frequency (MHz)	Tunable Range (MHz)	Resonant Frequency (MHz)	Tunable Range (MHz)
3000	60	11600	232	28000	560
3100	62	11800	236	28500	570
3200	64	12000	240	29000	580
3300	66	12200	244	29500	590
3400	68	12400	248	30000	600
3500	70	12600	252	30600	612
3600	72	12800	256	31200	624
3700	74	13000	260	31800	636
3800	76	13200	264	32400	648
3900	78	13400	268	33000	660
4000	80	13600	272	33600	672
4100	82	13800	276	34200	684
4200	84	14000	280	34800	696
4300	86	14200	284	35000	700
4400	88	14400	288	35700	714
4500	90	14600	292	36400	728
4600	92	14800	296	37100	742
4700	94	15000	300	37800	756
4800	96	15300	306	38500	770
4900	98	15600	312	39200	784
5000	100	15900	318	39900	798
5200	104	16200	324	40000	800
5400	108	16500	330	40800	816
5600	112	16800	336	41600	832
5800	116	17100	342	42400	848
6000	120	17400	348	43200	864
6200	124	17700	354	44000	880
6400	128	18000	360	44800	896
6600	132	18300	366	45000	900
6800	136	18600	372	45900	918
7000	140	18900	378	46800	936
7200	144	19200	384	47700	954
7400	148	19500	390	48600	972
7600	152	19800	396	49500	990
7800	156	20000	400	50000	1000
8000	160	20400	408	51000	1020
8200	164	20800	416	52000	1040
8400	168	21200	424	53000	1060
8600	172	21600	432	54000	1080
8800	176	22000	440	55000	1100
9000	180	22400	448	56100	1122
9200	184	22800	456	57200	1144
9400	188	23200	464	58300	1166
9600	192	23600	472	59400	1188
9800	196	24000	480	60000	1200
10000	200	24400	488	61200	1224
10200	204	24800	496	62400	1248
10400	208	25000	500	63600	1272
10600	212	25500	510	64800	1296
10800	216	26000	520	66000	1320
11000	220	26500	530	67000	1340
11200	224	27000	540		
11400	228	27500	550		

\*1 Frequency Tolerance 0.1~1% \*2 Over the range -60°C to +125°C

The graph to the left shows a 9.9GHz resonator tuned down in frequency by laser trimming slots through the gold metallization. In this particular example the part was lasered approximately 96MHz lower than its true resonant frequency. Tuning resonators up in frequency is possible by using photolithography to define slots on the top side of the resonator circuit. Wirebonding across the slots will tune the device up in frequency.

## Estimating Resonator Size

The size of the cavity resonator is determined by the desired resonant frequency and the ceramic material selected. At the same resonant frequency, a higher dielectric constant material will offer reduced size compared to a lower dielectric constant material. Resonators are typically designed on thick ceramics due to Q increasing with material thickness.

These graphs can be used as a guide for estimating resonator sizes on typical DLI materials. Designs are slightly rectangular in shape. Length to width aspect ratios are usually less than 1.2:1. For additional information consult the factory.

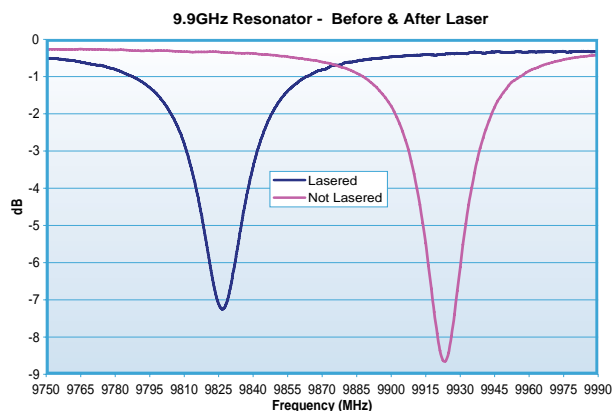
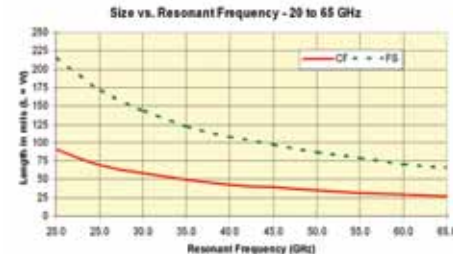
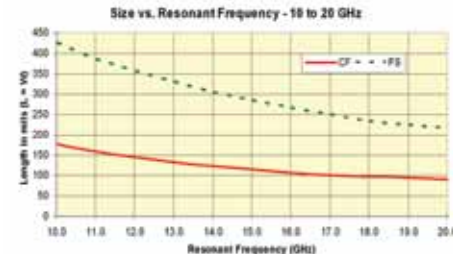
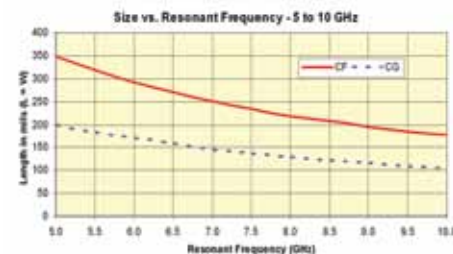
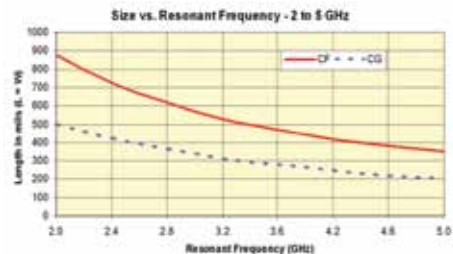

# Thin Film - Single Frequency Cavity Resonator

## Mounting Alternatives

The illustrations demonstrate a surface mounting technique. The first resonator is positioned with the I/O pad in view to demonstrate the alignment with the printed wire board geometry [1]. The second illustration shows the resonator mounted in position [2]. The third illustration shows the printed wire board geometry [3a-c]. A solder mask is used to control the flow of solder during assembly and insulate the input line from shorting to the resonator ground metallization. A solderable metal scheme with a nickel barrier will be employed on the resonators. A thin outer layer of gold will prevent oxidation of the nickel.

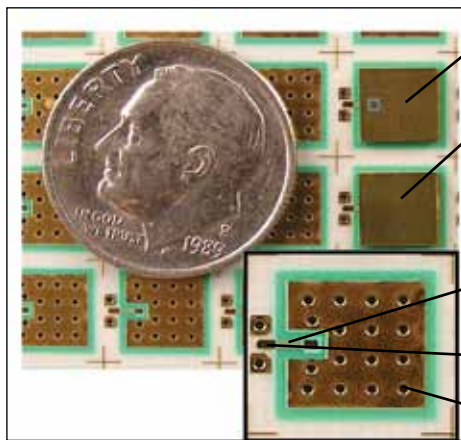

- 1) Resonator mounting surface shown facing up (contact pad is visible)
- 2) SMT resonator shown in normal mounted orientation
- 3) Typical circuit board layout for SMT resonator mounting:
  - a) Solder mask, insulates input line from shorting to ground
  - b) Input line
  - c) Ground vias in board

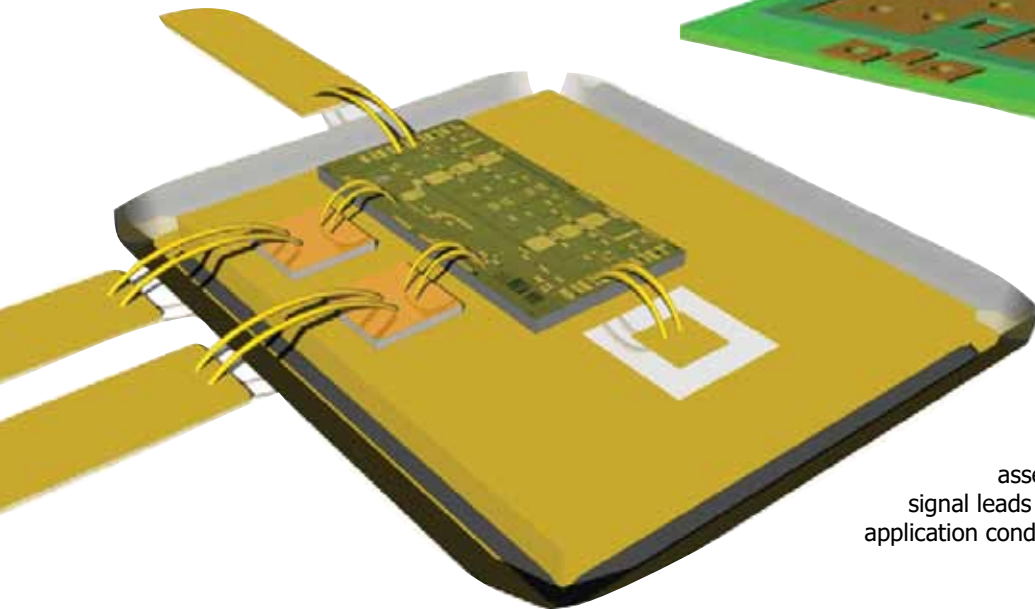
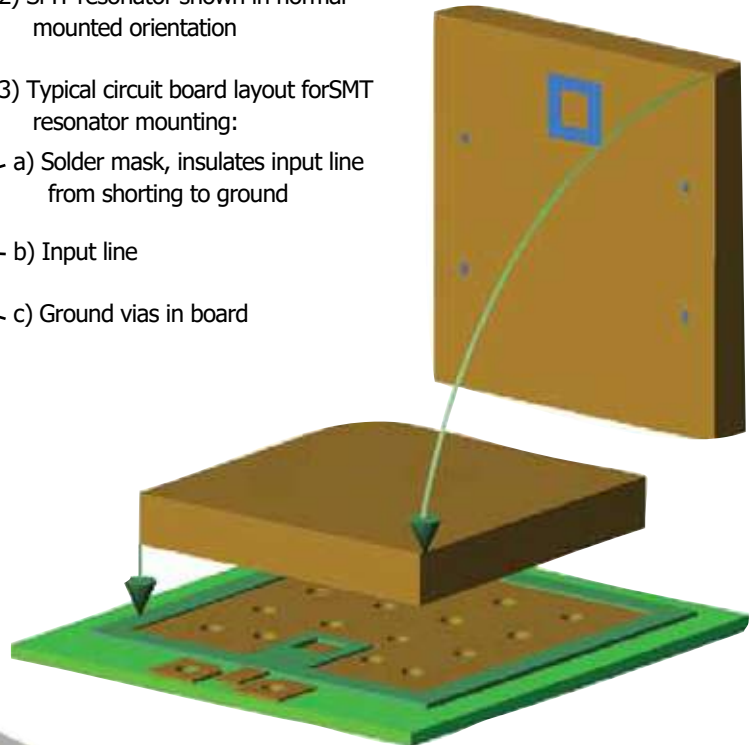

## Microstrip Mount

This picture illustrates a microstrip mounting technique. Shown is an implementation where the active device and power supply bypass capacitors are assembled onto the resonator. The wirebond signal leads are kept as short as possible. In a typical application conductive epoxy would be used to attach the resonator to the circuit.



# Thin Film - Self Bias Network

## Description

- Wireless communication modules
- MIC broadband high gain RF/Microwave module
- Bias line voltage divider and integrated decoupling capacitor
- Simplifies assembly with 1 component
- Improves gain flatness and stability in GaAs FET
- Miniature size: .020 x .034 (.5mm x .86mm)

## Physical Characteristics

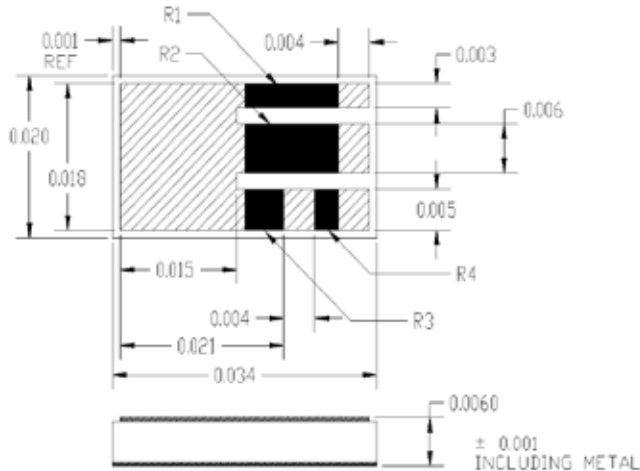

## Equivalent Schematic Representation

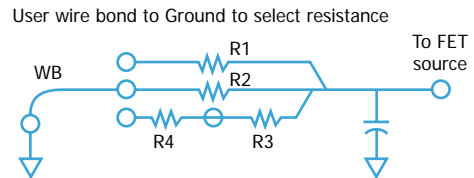

**Resistor Values:**      **Nominal Capacitance:**

- R1 - 200 $\Omega$
- R2 - 100 $\Omega$
- R3 - 50 $\Omega$
- R4 - 20 $\Omega$

50pF

Typical application requires 2 networks

**Recommended Mounting:** The self Bias Network should be mounted with fully metallized side down directly on the RF ground plane for best performance.

## Part Number Identification

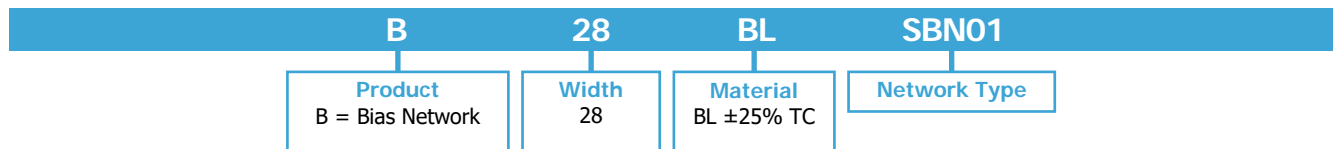

## Physical Characteristics

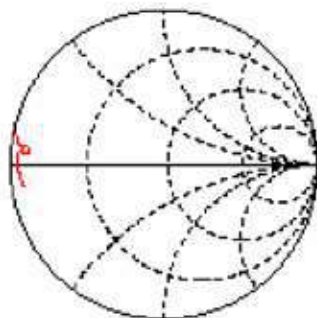

Typical S11  
Frequency Range: 1.0 to 20 GHz  
Reflection Coefficient: 50% Normalized

## Typical Application

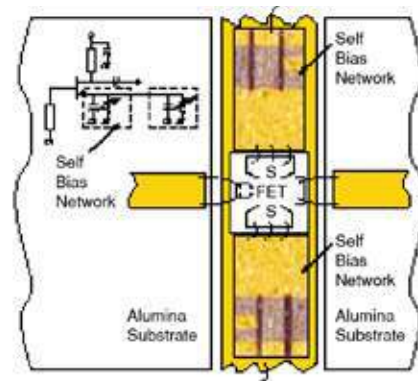

Custom Networks can be designed per customer specification. Please consult factory for additional information or special requirements.

# Thin Film - Bias Filter Network

## Description

- Wireless communication modules • Ideal varactor decoupling element • High gain RF/Microwave modules
- Ideal GaAs FET gate biasing device • MMIC multichip modules

## Functional Applications

- Filters noise and RF from Supplies
- Reduces RF feedback through bias supplies
- Simplifies assembly - one component replaces many
- Designed with large 4 mil wirebond pads for assembly ease



## Equivalent Schematic Representation

**Total Series Resistance:**      **Total Shunt Capacitance:**  
**DC Rating:** Volts Max: 50V      **I (ma) Max:** 10Ma

**Recommended Mounting:** The Bias Filter Network should be mounted with fully metallized side down directly on RF ground plane for maximum isolation performance.

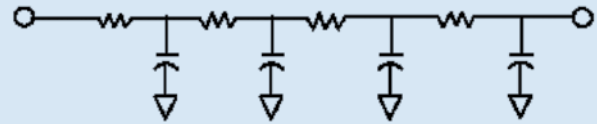

## Physical Characteristics

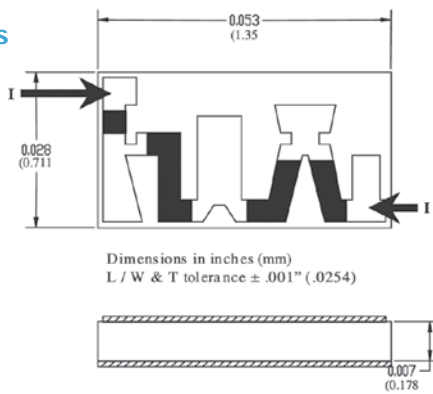

## Typical Application

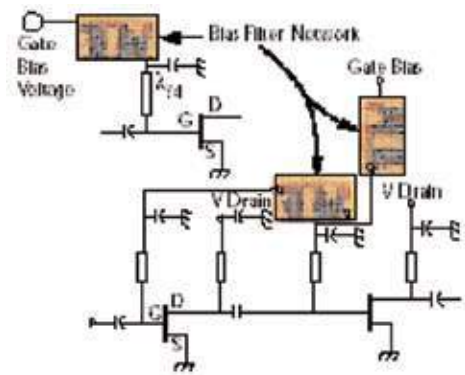

## Part Number Identification

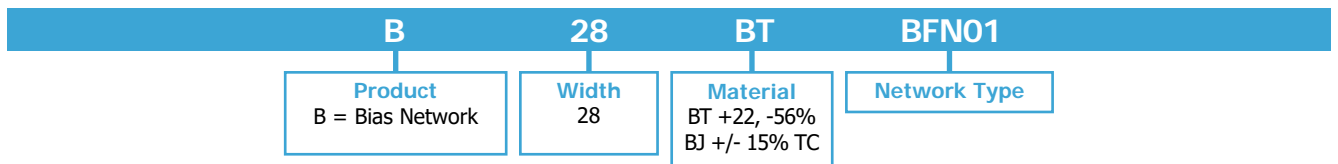

## Isolation vs. Frequency

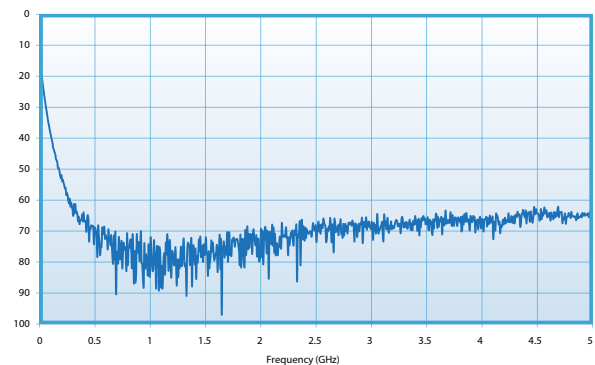
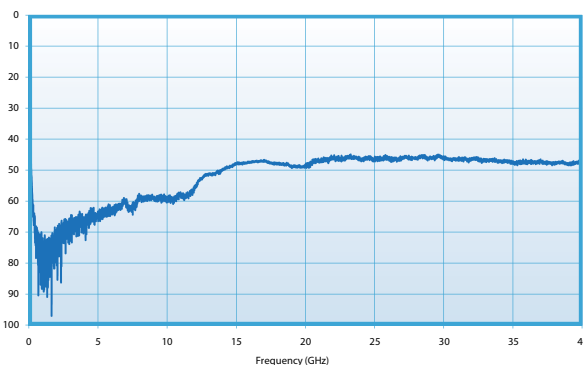

Custom Networks can be designed per customer specification. Please consult factory for additional information or special requirements.

# Thin Film - Gain Equalizer

## Description

- Equalizer compensates for module Gain Slope
- Broadband communications, radar, phased arrays
- SONET modules to 40+ GHz
- RADAR applications to >67 GHz
- Superior microwave performance
- Excellent repeatability
- Ease of assembly, reduced size and cost
- Designed with large 4 mil wirebond pads for assembly ease

## Physical Characteristics

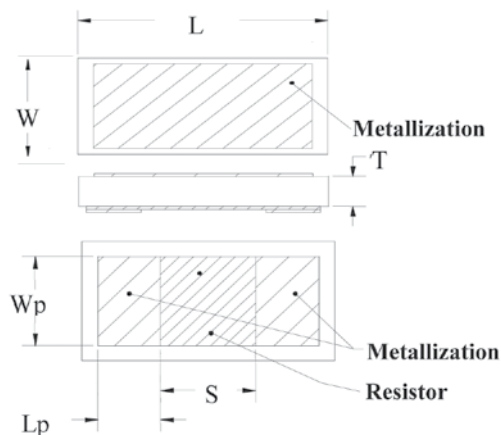

## Mounting attachment material:

Epoxy or Solder

### • Metallization - Epoxy mount:

Top: 100  $\mu$  inch Au min over 300 Angstroms TiW min.  
Bottom: 100  $\mu$  inch Au min over 300 Angstroms TiW min over TaN resistor

### • Metallization - Solder mount:

Top side: 100  $\mu$  inch min. over 50  $\mu$  inch NiV min. over 300 Angstroms TiW min.  
Bottom side: 25  $\mu$  inch min. over 50  $\mu$  inch NiV min. over 300 Angstroms TiW min. over TaN resistor

## Die attachment recommendations:

The gap in the microstrip line should nominally be equal to dimension "S" (see equalizer outline on Page 64).



## Performance

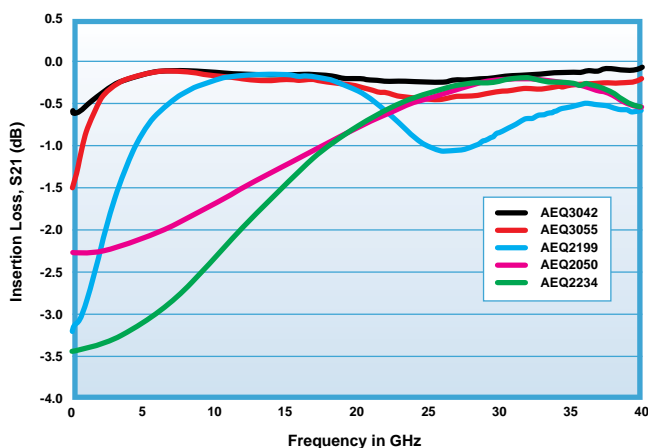

Excellent, repeatable microwave performance is achieved by application of precision thin film fabrication and DLI Hi-K Ceramic materials. DLI's unique design solution provides near Ideal R-C frequency response, far superior to "Stacked R-C chip" Assemblies.

## Equivalent Schematic Representation

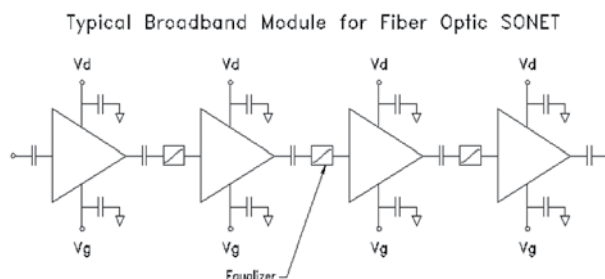

Part #	Resistor (R)	Low Frequency Insertion Loss, 50 ohm system (dB)	Equivalent Capacitance (pF)	F <sub>0</sub> (GHz)	Mounting Attachment Material: S=solder E=epoxy	L	W	T
AEQ 2050	30 $\Omega$	-2.2	0.33	34	E	0.030" $\pm$ .002" (.762 $\pm$ .051mm)	0.018" $\pm$ .002" (.457 $\pm$ .051mm)	0.005" $\pm$ .001" (.127 $\pm$ .025mm)
AEQ 2199	43 $\Omega$	-3.0	1.15	16	E	0.028" $\pm$ .002" (.711 $\pm$ .051mm)	0.016" $\pm$ .002" (.406 $\pm$ .051mm)	0.007" $\pm$ .001" (.178 $\pm$ .025mm)
AEQ 2234	50 $\Omega$	-3.5	0.31	32	E	0.032" $\pm$ .002" (.813 $\pm$ .051mm)	0.016" $\pm$ .002" (.406 $\pm$ .051mm)	0.005" $\pm$ .001" (.127 $\pm$ .025mm)
AEQ 3042	9 $\Omega$	-0.8	12.5	7	S	0.040" $\pm$ .002" (1.02 $\pm$ .051mm)	0.020" $\pm$ .002" (.508 $\pm$ .051mm)	0.006" $\pm$ .001" (.152 $\pm$ .025mm)
AEQ 3055	20 $\Omega$	-1.6	9.0	7	S	0.040" $\pm$ .002" (1.02 $\pm$ .051mm)	0.020" $\pm$ .002" (.508 $\pm$ .051mm)	0.006" $\pm$ .001" (.152 $\pm$ .025mm)

# Thin Film - DC to 18 GHz EW Series Gain Equalizers

## Description

DLI's Gain Equalizers are designed as a small, low cost solution to your gain slope challenges. DLI's EW Series is designed to address this issue from DC to 18 GHz in a package smaller than an 0302 capacitor. Components are designed for surface mount pick and place equipment or epoxy mount.

Available in tape and reel packaging for high volume applications.

## Applications

- Broadband Microwave Modules; EW, ECM, ECCM
- Equalizer is utilized as a compensation circuit to correct for loss slope created by other circuit elements such as amplifiers

## Benefits

- Footprint interchangeable part series, gain slopes from 1 to 3.5 dB
- Superior, repeatable microwave performance
- Ease of assembly; terminations are compatible with solder SMT and conductive epoxy assembly
- Package optimized for typical 50 W transmission line width
- No ground connection required

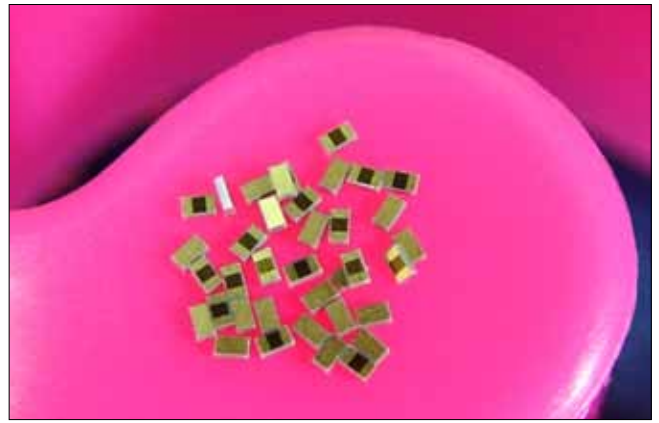

## Equivalent Schematic Representation

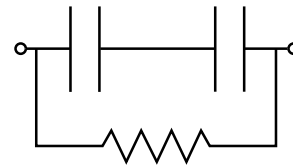

## Part Numbers - DC to 18 GHz EW Series Gain Equalizers

Part Number	L	W	T	Lp	Wp	G	Attach method	Nominal Slope
AEQ05467	28 ± 1	16 ± 1	7 ± 1	7 min.	14 ± 1	10	Solder/Epoxy	1.0 dB
AEQ05468	28 ± 1	16 ± 1	7 ± 1	7 min.	14 ± 1	10	Solder/Epoxy	1.5 dB
AEQ05469	28 ± 1	16 ± 1	7 ± 1	7 min.	14 ± 1	10	Solder/Epoxy	2.0 dB
AEQ05470	28 ± 1	16 ± 1	7 ± 1	7 min.	14 ± 1	10	Solder/Epoxy	2.5 dB
AEQ05471	28 ± 1	16 ± 1	7 ± 1	7 min.	14 ± 1	10	Solder/Epoxy	3.0 dB
AEQ05472	28 ± 1	16 ± 1	7 ± 1	7 min.	14 ± 1	10	Solder/Epoxy	3.5 dB

All dimensions in mils

## Typical Performance

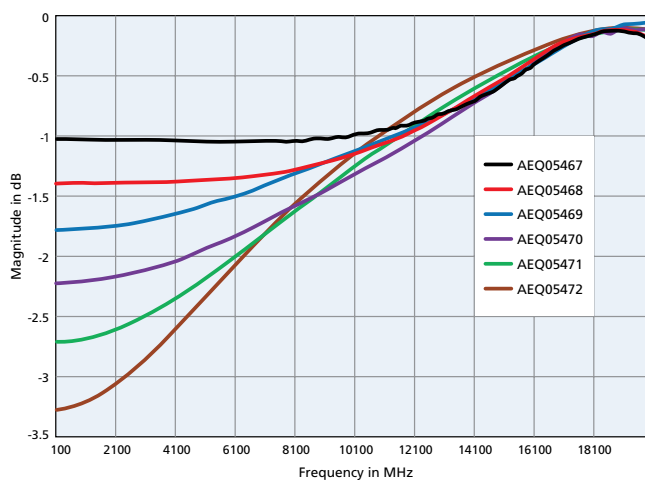

## Die Attach Recommendations

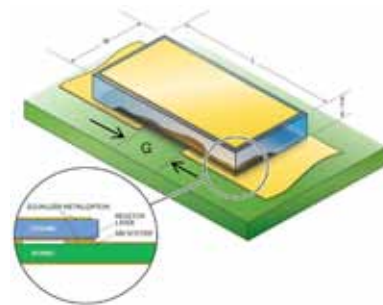

- 1) Equalizer width should be approximately as wide as 50 Ω line trace on PCB.
- 2) The gap in the microstrip line should be nominally equal to dimension G.
- 3) Vacuum pick-up tool recommended for component handling. If pressure is to be applied during component placement, it should be done uniformly across the part.
- 4) Thin, unmounted circuit boards are prone to warpage during reflow. This can cause solder attach defects and cracking of components during handling or subsequent housing installation.

# Thin Film - Gain Equalizer

DLI's miniature Thin Film Gain Equalizers have a microwave frequency response which is so close to ideal that it can be modeled by the simple parallel R-C circuit shown below. This is a convenient model for Spice (time domain) simulations. Other common equalizer implementations using stacked R-C chips are not accurately modeled by this circuit. For highest accuracy frequency domain simulations, S-parameters are recommended.

The "stacked R-C chip" implementation, illustrated in the figure below has many issues in both design and manufacturing which lead to lower performance and higher product cost. The equivalent circuit model below more accurately predicts the frequency response of the stacked chips. At microwave frequencies, the additional parasitic circuit elements are required. The effect of ESL, the equivalent inductance of the chip capacitor is particularly important as it causes a more peaked response as seen in the graph (right).

DLI's gain equalizer frequency response is compared with that of an ideal R-C, and stacked R-C chips in the figure below. The stacked R-C chip model utilizes the same Rchip and Cchip values as in the ideal R-C model. The key point is that the chip component R and C values used in a stacked chip equalizer are generally not the ideal values for specifying the DLI single chip gain equalizer. The next section discusses specifying the part by frequency response parameters, or in terms of the ideal R-C values.

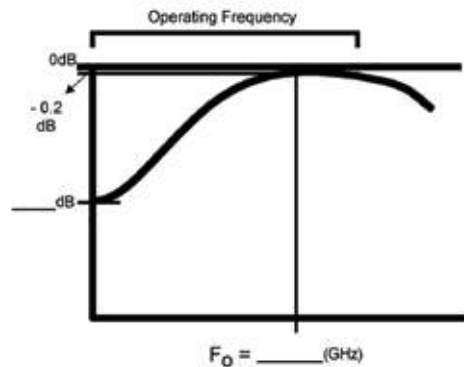
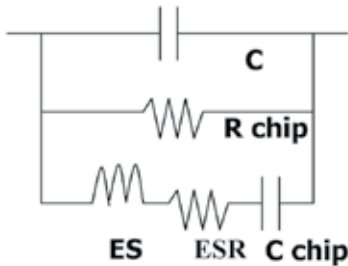
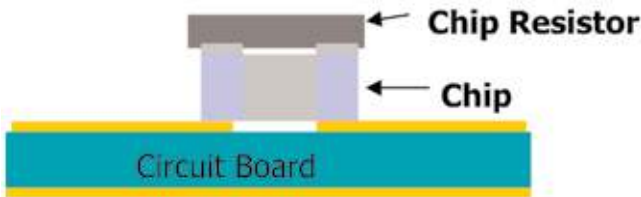
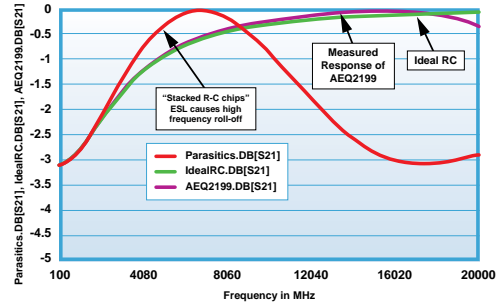

## Custom Equalizer Design Inputs:

- Low frequency loss or resistance value
- $F_0$  - minimum loss frequency or capacitance determined using equivalent circuit model on Page 64
- Case size restrictions - 50 ohm microstrip line width is a typical maximum case width objective

Case Size (inches) Preferred: \_\_\_\_\_ Maximum Length: \_\_\_\_\_ Maximum Width \_\_\_\_\_

Minimum Loss Frequency (GHz)  $F_0$  \_\_\_\_\_ GHz

Low Frequency Loss (dB), 50 ohm system Design Resistance (ohms): \_\_\_\_\_ Loss(dB): \_\_\_\_\_

Operating Temperature Range (C°) Minimum Temperature: \_\_\_\_\_ Maximum Temperature: \_\_\_\_\_

Power Dissipation (mw)

Assembly Method (SMT or Epoxy) Conductive Epoxy attach: \_\_\_\_\_ Solder attach: \_\_\_\_\_ Solder type: \_\_\_\_\_

Board Material Material: \_\_\_\_\_ Dielectric constant: \_\_\_\_\_ Thickness: \_\_\_\_\_

## What makes DLI RTP services unique?

Dielectric Laboratories, Inc. (DLI) has built its reputation as a manufacturer of High frequency, High Q Capacitors and is your global partner for application specific microwave and millimeterwave components serving customers in fiber optic, wireless, medical, transportation, semiconductor, space, avionics and military markets.

The marriage of ceramic expertise, manufacturing know-how, product quality, customer service, product customization, and clever microwave and RF design engineering sets us apart from all others in the industry.

With over three decades of material science formulation and development, more than one hundred proprietary and/or patented ceramic formulations, and multiple recent patent filings, DLI is the pre-eminent ceramic component manufacturer in the industry. You can turn to DLI with confidence for your high frequency Single-Layer Capacitors, Multi-Layer Capacitors that are difficult to build and tight tolerance; Heat Sinks, Resonators, Filters, and Build-To-Print or Custom Thin Film Components.

### Typical Applications

- Heat Sinks and Standoff
- Integrated Passive Components
- Custom Resistor Capacitor Networks
- Lange Couplers, Power Combiners
- EMI Filters
- High Frequency Filters
- Microwave Integrated Circuits (MIC)
- Bias Decoupling and Filtering
- Lumped Element Impedance Matching Network
- PA Stabilization
- Impedance Matching and Power Combining Network

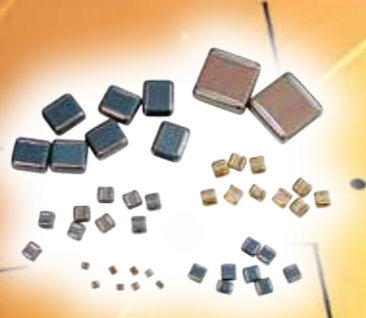

### Build-to-Print Reference Guide

#### Metal Coatings

- Gold (Au) • Nickel (Ni) • Titanium Tungsten (TiW) • Platinum (Pt)
- Titanium (Ti) • Copper (Cu) • Nickel Vanadium (NiV)
- Gold Tin (AuSn) • Tantalum Nitride (TaN) (Resistive Layer)

#### Lithography

Conductor Thickness	Line width and Spacing
Gold $\leq 150 \mu\text{m}$	$\leq 0.5 \pm 0.1 \text{ mil}$
Gold 150 - 300 $\mu\text{m}$	$1.0 \pm 0.2 \text{ mil}$
Copper 50 - 600 $\mu\text{m}$	$3.0 \pm 0.4 \text{ mil}$
Nickel 50 - 125 $\mu\text{m}$	$3.0 \pm 0.4 \text{ mil}$

#### Laser Drilling

- Features as small as 0.003" dia.
- Drill features in high K dielectrics

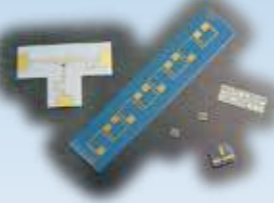

#### Other Options

- Edge-wrap Metallization • Castelated Vias • Gold Filled Vias
- Reinforced Vias • Spiral Inductors • Interdigitated Capacitors
- Lange Coupler • Resistors - Notched, Flush, Top-Hat • Polyimide
- Solder Dam • RF test capabilities up to 67 GHz
- Contoured Surfaces - (non-rectangular shapes)
- Selective Metallization - Different top and bottom substrate metal scheme. Different metal schemes on the same side of substrate
- Packaging - Photon Ring packaging, repopulation, Tape and Reel Anti-Static Waffle packaging up to 4" square

### TF Coupon

Resistors can be incorporated directly into the circuit design with the advantage of reducing assembly steps, improving thermal dissipation and improving reliability through the reduction of interconnections.

DLI's resistor technology utilizes TaN. This material has higher maximum exposure temperature and superior resistance to harsh environments (soldering and processing).

Under most circumstances DLI can tune a resistor in to tolerance of 10% without trimming. When tighter tolerance is required laser trimming is available.

DLI offers reinforced vias when higher current is required which gives better mechanical strength and lower resistance to the via hole.

Filled vias provide improved performance and reliability over plated vias but have a higher processing cost. Filled vias increase current carrying capacity and have higher thermal conductivity to the ground plane. When mounting active die, use of filled vias effectively conducts heat away from the die.

DLI offers gold fill (copper or silver can diffuse into other layers of the metallization leading to reliability issues).

The precision of conductor line width and line spacing can be critical to achieving the performance required. Control of metal geometries is key to repeatable performance in microwave structures. Characteristic impedance of transmission lines is governed by line widths. DLI has extensive experience and can assist in tailoring ceramic/metallization systems to your design to achieve maximum performance. DLI is capable of meeting as small as 0.0005" line width and spacing with 0.0001" tolerance.



CHOOSING A SUBSTRATE

CHOOSING A METAL SYSTEM

## CUSTOMER DESIGNED FILTERS

DLI is a premier manufacturer of custom designed thin film filters. DLI combines its RF design knowledge, testing capabilities, materials characterization expertise with our precision manufacturing capabilities to provide our customers with repeatable designs. Customers may provide designs on 99.6% alumina or are free to design filters using DLI's high K, high Q, temperature stable dielectrics to receive a smaller, lighter and higher performing filter. We can deliver these filters tested with known good yield.

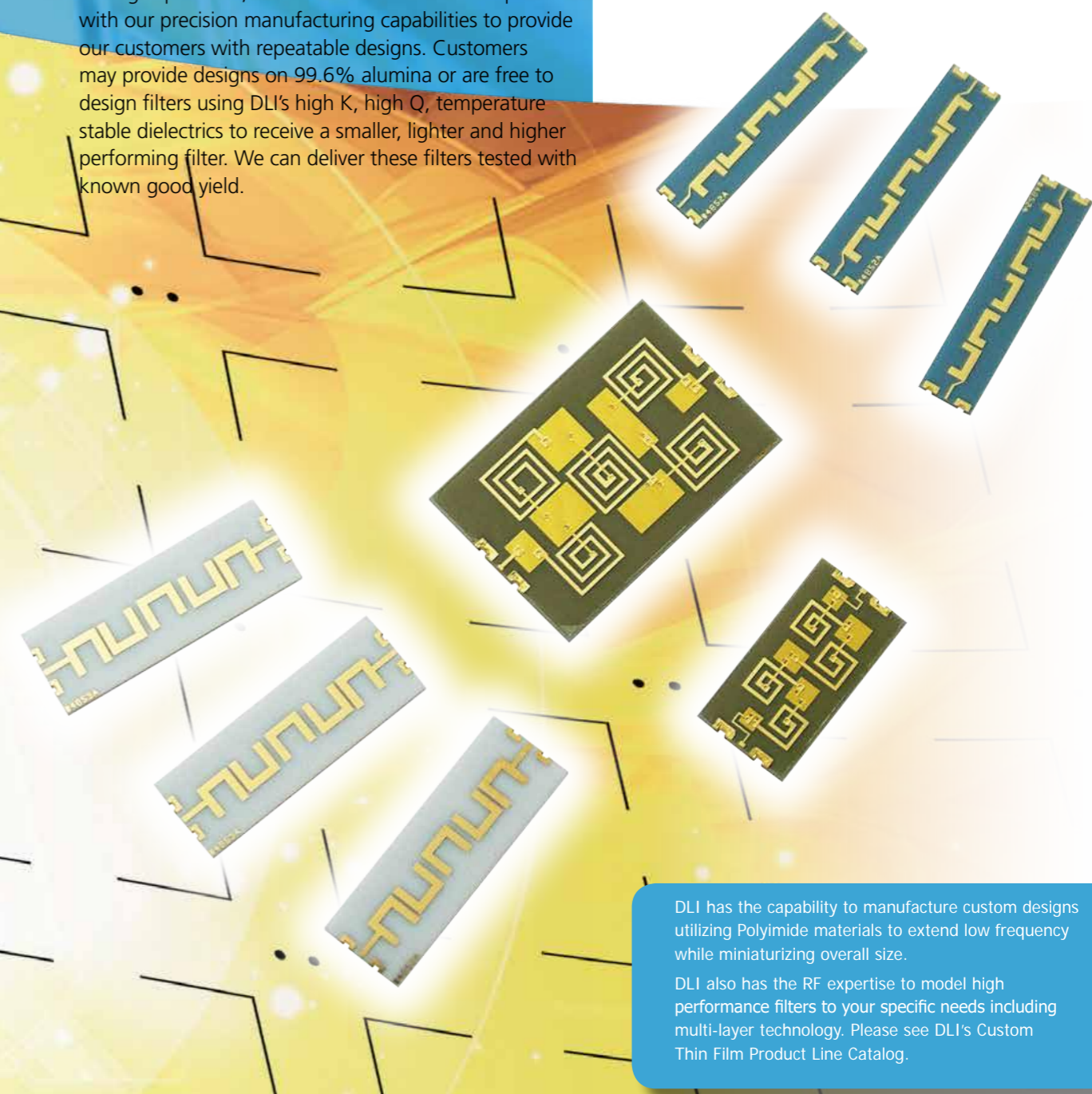

DLI has the capability to manufacture custom designs utilizing Polyimide materials to extend low frequency while miniaturizing overall size.

DLI also has the RF expertise to model high performance filters to your specific needs including multi-layer technology. Please see DLI's Custom Thin Film Product Line Catalog.

Build-to-Print or Build-to-Performance - You make the Choice!

Substrate Material	Dielectric Constant (Tolerance)	Typical Loss Tangent	Coefficient of Thermal Expansion (ppm/°K)	Temperature Coefficient of Capacitance (ppm/°C)	Surface Finish (μ-inch)	Application
Fused Quartz (SiO2) QZ	3.82 @ 1MHz	0.000015 @ 1MHz 0.00033 @ 24GHz	0.55	—	<0.1	Suitable for microwave and millimeter wave frequency applications. Low loss. Thermal Conductivity: 1.38 W/m-K.
Aluminum Nitride (AlN) AG	8.6 (±0.35) @ 1MHz	0.005 @ 8GHz	4.6	—	As Fired <20 Polished <2	Suitable for circuits requiring high power dissipation. RF and microwave circuit applications. Thermal Conductivity: 170 W/m-K or 200 W/m-K
96% Alumina (Al2O3) PJ	9.5 (±1) @ 1MHz	0.0004	6.4 - 8.2	—	As Fired <4 Polished <1	General circuit applications. Compatible with Si and GaAs chip technology. Thermal Conductivity: 26 W/m-K.
99.6% Alumina (Al2O3) PI	9.9 (±0.15) @1MHz	0.0001	6.5 - 7.5	P120 ± 30	As Fired ≤3 Polished <5	General circuit applications. Compatible with Si and GaAs chip technology. Thermal Conductivity: 27 W/m-K.
PG	13.3 (±0.5)	0.0005	7.6	P22 ± 30	Polished <5	Replacement for Alumina - improved temperature stability.
AH	20 (±0.5)	0.0002	9.6	P90 ± 20	Polished <5	Suitable for circuit miniaturization. RF and microwave circuit applications.
NA	23 (±0.5)	0.0003	10.1	N30 ± 15	Polished <5	Suitable for circuit miniaturization. RF and microwave circuit applications.
CF	25 (±0.5)	0.0003	9.0	0 ± 15	Polished <5	Excellent temperature stability. Suitable for circuit miniaturization. RF and microwave circuit applications.
CD	38 (±1)	0.0005	5.8	N20 ± 15	Polished <5	Suitable for circuit miniaturization. RF and microwave circuit applications.
CG	67 (±1)	0.0009	9.0	0 ± 30	Polished <5 Lapped <20	Excellent temperature stability. Suitable for circuit miniaturization. RF and microwave circuit applications.
NP	85 (±5%)	0.0003	—	N750 ± 200	Polished <5	Suitable for circuit miniaturization. RF and microwave circuit applications. Microwave power transistor matching; eg. GaN, SiC
NR	152 (±5%)	0.0006	10.0	N1500 ± 500	Polished <5	
NS	300 (±10%)	0.005	—	N2400 ± 500	Polished <5	
NU	600 (±10%)	0.015	—	N3700 ± 1000	Polished <5	

Standard substrate thicknesses are in 5 and 10mil thick increments but can be custom to 0.1mil. Polished and lapped surfaces are available to ±0.0005" tolerance where As-Fired materials are accurate to ±0.001". Alternative surface finishes may also be available, please consult the factory for more options.



Metalization System	Application	Component Attachment Method	Typical Thickness Range	Comments	Maximum Use Temperature °C
Tantalum Nitride (TaN) Titanium Tungsten (TiW) Gold (Au)	Standard Thin Film Metal System for Conductors with Resistor Layer	Au/Sn, Au/Si, Au/Ge - Eutectic, Epoxy	TaN: 12 to 200 Ω / □ TiW: 300 to 500 Å Au: 5 to 300 μ"	Not recommended for Tin/Lead Solder Attach - Maintain Gold 5-20 μ" for Solder Attach.	380
Titanium Tungsten (TiW) Gold (Au)	Standard Thin Film Metal System for Conductors	Au/Sn, Au/Si, Au/Ge - Eutectic, Sn/Pb, Epoxy	TiW: 300 to 500 Å Au: 5 to 300 μ"	Compatible with Wire bonding - Maintain Gold ≥100 μ" for Wire bonding.	425
Tantalum Nitride (TaN) Titanium Tungsten (TiW) Gold (Au) Copper (Cu) Nickel (Ni) Gold (Au)	High Current & Low Loss with or without TaN Resistor Layer	Au/Sn, Au/Si, Au/Ge - Eutectic, Sn/Pb, Epoxy	TaN: 12 to 200 Ω / □ TiW: 300 to 500 Å Au: 5 to 10 μ" Cu:150 to 600 μ" NiV: 40 to 100 μ" Au:5 to 300 μ"	Compatible with Tin/Lead Solder Attach - Maintain exposed surface Gold 5-20 μ" for Sn/Pb Solder Attach when repeated soldering is required for repairs.	350
Tantalum Nitride (TaN) Titanium Tungsten (TiW) Gold (Au) Nickel (Ni) Gold (Au)	High Current & Low Loss with or without TaN Resistor Layer	Au/Sn, Au/Si, Au/Ge - Eutectic, Sn/Pb, Epoxy	TaN: 12 to 200 Ω / □ TiW: 300 to 500 Å Au: 5 to 300 μ" NiV: 40 to 100 μ" Au: 5 to 70 μ"	Compatible with Wire bonding - Maintain Gold ≥100 μ" for Wire bonding.	350
Tantalum Nitride (TaN) Titanium Tungsten (TiW) Gold (Au) Nickel (Ni) Gold Tin (AuSn)	With or without TaN Resistor Layer for selective Gold/Tin attach and wire bond locations	Au/Sn	TaN: 12 to 200 Ω / □ TiW: 300 to 500 Å Au: 5 to 10 μ" NiV: 40 to 100 μ" Au:5 to 300 μ"	Eliminates solder preform. Direct die attach to pad (Au/Sn). Selective Areas available for Wire bonding.	280
Titanium Tungsten (TiW) Nickel (Ni) Gold Tin (AuSn)	For Gold/Tin Solder Systems without TaN Resistor Layer	Au/Sn	TiW: 300 to 500 Å NiV: 40 to 100 μ" AuSn: 100 to 350 μ"		280
Titanium Tungsten (TiW) Platinum (Pt) Gold (Au)	Heat sink applications	Au/Sn, Au/Si, Au/Ge - Eutectic, Sn/Pb, Epoxy	TiW: 300 to 500 Å Pt: 6-10 μ" Au: 5 to 300 μ"	Compatible with Tin/Lead Solder Attach - Maintain Gold 5-20 μ" for Solder Attach when repeated soldering is required for repairs.	>400
Titanium Tungsten (TiW) Nickel (Ni) Gold (Au)	Standard Thin Film metal system for conductors	Sn/Pb, Au/Sn, Au/Si, Au/Ge - Eutectic, Epoxy	TiW: 300 to 500 Å NiV: 40 to 100 μ" Au: 5 to 300 μ"	Compatible with Wire bonding - Maintain Gold ≥100 μ" for Wire bonding.	350

Note: Titanium can be substituted depending on substrate composition. Custom Metalizations and thicknesses are available upon request. Nickel Vanadium may be substituted for Nickel in some applications; contact applications engineering for details.

The metal system utilized is typically chosen based on the the following requirements: current carrying requirement, chip and component mounting strategies, line width and spacing requirements and if utilizing an integrated resistor.

Higher current requirements can employ thicker gold or copper metal but that limits the ability for fine line geometries. Wire bonding to the surface of a circuit generally requires 100 μ" of gold. When tin/lead soldering is required, gold thickness is decreased to reduce embrittlement and a nickel/ platinum barrier layer is utilized.

DLI also has the capability to selectively apply gold/tin solder for attachment of discrete die.

Note: For lower frequency filter (<4 GHz) designs, DLI suggests using a minimum gold thickness of 150μ". Higher frequency designs should use the standard 100μ" gold thickness.



# knowles

DLI•JohansonMFG•Novacap•Syfer•Voltronics

Knowles Capacitors designs, manufactures and sells special electronic components. Our products are used in military, space, telecom infrastructure, medical and industrial applications where function and reliability are crucial.



Knowles (Cazenovia)  
2777 Route 20 East, Cazenovia,  
NY 13035 USA

Phone: +1 315 655 8710  
Fax: +1 315 655 0445  
KCCSales@knowles.com



Knowles (Valencia)  
25111 Anza Drive, Valencia,  
CA 91355 USA

Phone: +1 661 295 5920  
Fax: +1 661 295 5928  
NovacapSales@knowles.com



Knowles (UK) Ltd  
Hethel Engineering Centre, Chapman Way,  
Hethel, Norwich, Norfolk NR14 8FB

Phone: +44 1603 723300  
Fax: +44 1603 723301  
SyferSales@knowles.com



Knowles (Cazenovia)  
2777 Route 20 East, Cazenovia,  
NY 13035 USA

Phone: +1 315 655 8710  
Fax: +1 315 655 0445  
VoltronicsSales@knowles.com