

DESCRIPTION

The MP8102 is a rail-to-rail output, operational amplifier in a TSOT-23 package. This amplifier provides 600KHz bandwidth while consuming an incredibly low 7.5 μ A of supply current. The MP8102 can operate with a single supply voltage as low as 1.8V.

FEATURES

- Single Supply Operation: 1.8V to 5.5V
- TSOT23-5 Package
- 600KHz -3 dB Bandwidth
- 7.5 μ A Supply Current
- Rail-to-Rail Output
- Unity-Gain Stable
- Input Common Mode to Ground
- Drives Up to 1000pF of Capacitive Loads

APPLICATIONS

- Portable Equipment
- PDAs
- Pagers
- Cordless Phones
- Handheld GPS
- Consumer Electronics

All MPS parts are lead-free, halogen free, and adhere to the RoHS directive. For MPS green status, please visit MPS website under Quality Assurance. "MPS" and "The Future of Analog IC Technology" are Registered Trademarks of Monolithic Power Systems, Inc.

TYPICAL APPLICATION

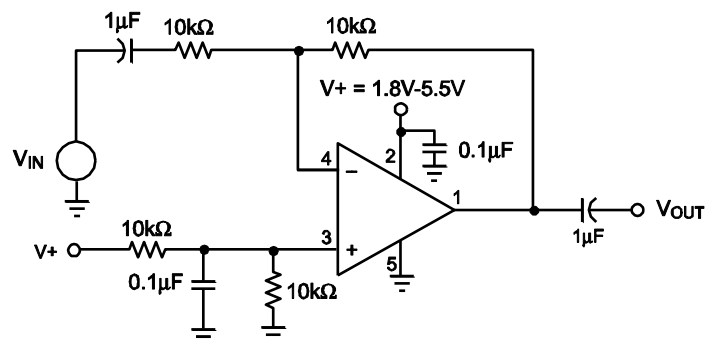

ORDERING INFORMATION

Part Number*	Package	Top Marking
MP8102DJ	TSOT23-5	See Below

* For Tape & Reel, add suffix -Z (e.g. MP8102DJ-Z);
 For RoHS, compliant packaging, add suffix -LF (e.g. MP8102DJ-LF-Z).

TOP MARKING

|H6YW

H6: product code of MP8102DJ;
 Y: year code;
 W: week code:

PACKAGE REFERENCE

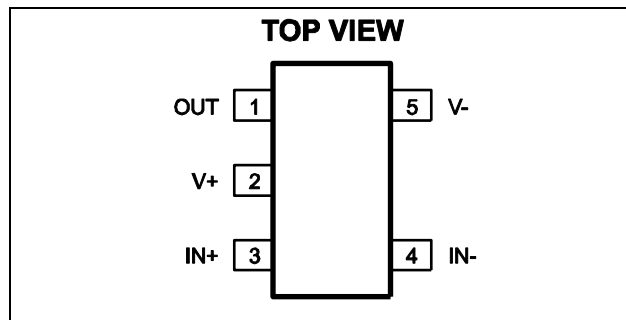

ABSOLUTE MAXIMUM RATINGS ⁽¹⁾

Supply Voltage (V+ to V-)+6.0V
 Differential Input Voltage ($V_{IN+} - V_{IN-}$).....+6.0V
 Input Voltage ($V_{IN+} - V_{IN-}$).. $V_{IN+} + 0.3V$, $V_{IN-} - 0.3V$
 Junction Temperature 150°C

Recommended Operating Conditions ⁽²⁾

Supply Voltage +1.8V to +5.5V
 Operating Temperature..... -40°C to +85°C

Thermal Resistance ⁽³⁾ θ_{JA} θ_{JC}
 TSOT23-5 220 110.. °C/W

Notes:

- 1) Exceeding these ratings may damage the device.
- 2) The device is not guaranteed to function outside of its operating conditions.
- 3) Measured on approximately 1" square of 1 oz copper.

ELECTRICAL CHARACTERISTICS

$V_+ = +5V$, $V_- = 0V$, $V_{CM} = V_+/2$, $R_L = 10k\Omega$, $T_A = +25^\circ C$, unless otherwise noted.

Parameter	Symbol	Condition	Min	Typ	Max	Units
Input Offset Voltage	V_{OS}		-5	1	+5	mV
Input Offset Voltage Temp Coefficient				15		$\mu V/^\circ C$
Input Bias Current ⁽⁴⁾	I_B			2		pA
Input Offset Current ⁽⁴⁾	I_{OS}			0.2		pA
Input Voltage Range	V_{CM}	CMRR > 60dB	0		3.8	V
Common-Mode Rejection Ratio	CMRR	$0 < V_{CM} < 3.5V$		82		dB
Power Supply Rejection Ratio	PSRR	Supply Voltage change of 1.0V		80		dB
Large Signal Voltage Gain	A_{VOL}	$R_L = 100k\Omega$, $V_{OUT} = 5.0$ Peak to Peak	60	88		dB
Maximum Output Voltage Swing	V_{OUT}	$R_L = 10k\Omega$		$V_+ - 23mV$		V
Minimum Output Voltage Swing	V_{OUT}	$R_L = 10k\Omega$		$V_- + 19mV$		V
Gain-Bandwidth Product ⁽⁴⁾	GBW	$R_L = 200k\Omega, C_L = 2pF$, $V_{OUT} = 0$		200		KHz
-3dB Bandwidth ⁽⁴⁾	BW	$A_V = 1, C_L = 2pF$, $R_L = 1M\Omega$		600		KHz
Slew Rate ⁽⁴⁾	SR	$A_V = 1, C_L = 2pF$, $R_L = 1M\Omega$		0.1		V/ μs
Short Circuit Current	I_{SC}	Source		-20		mA
		Sink		20		mA
Supply Current		No Load		7.5	10	μA

Note:

4) Guaranteed by design.

PIN FUNCTIONS

Pin #	Name	Description
1	OUT	Output.
2	V+	Supply Voltage.
3	IN+	Non-Inverting Input.
4	IN-	Inverting Input.
5	V-	Ground or Supply Return Pin.

TEST CIRCUITS

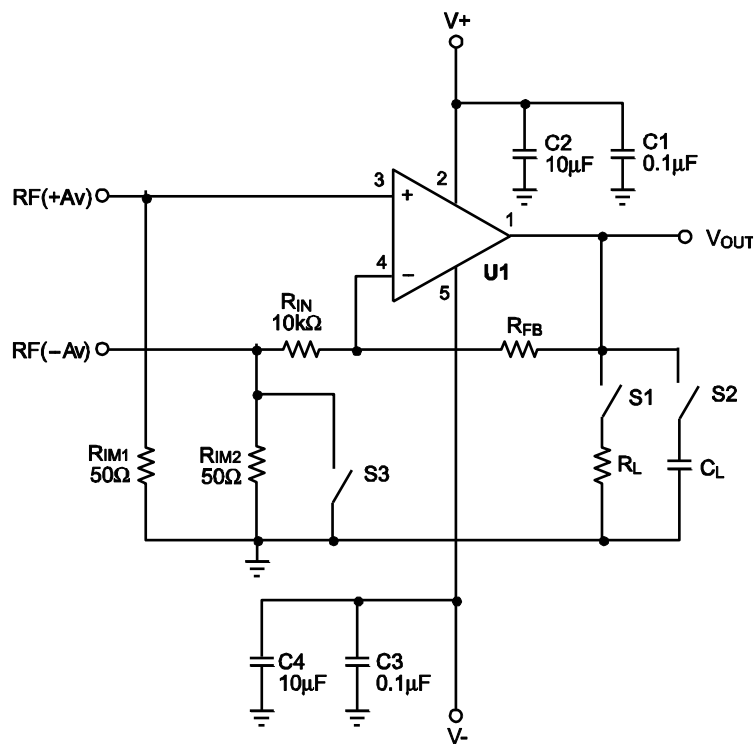

Notes: Close S3 for positive gain. Input signal to RF(+Av) connector.
 The gain $A_v = 1 + R_{FB}/R_{IN}$.
 For unity gain, remove R_{IN} and short R_{FB} .
 Open S3 for negative gain. Input signal to RF(-Av) connector.
 The gain $A_v = -R_{FB}/R_{IN}$.
 S1 and S2 are switches for possible resistor and capacitor load connections.

Figure 1—AC Test Circuit

TEST CIRCUITS (continued)

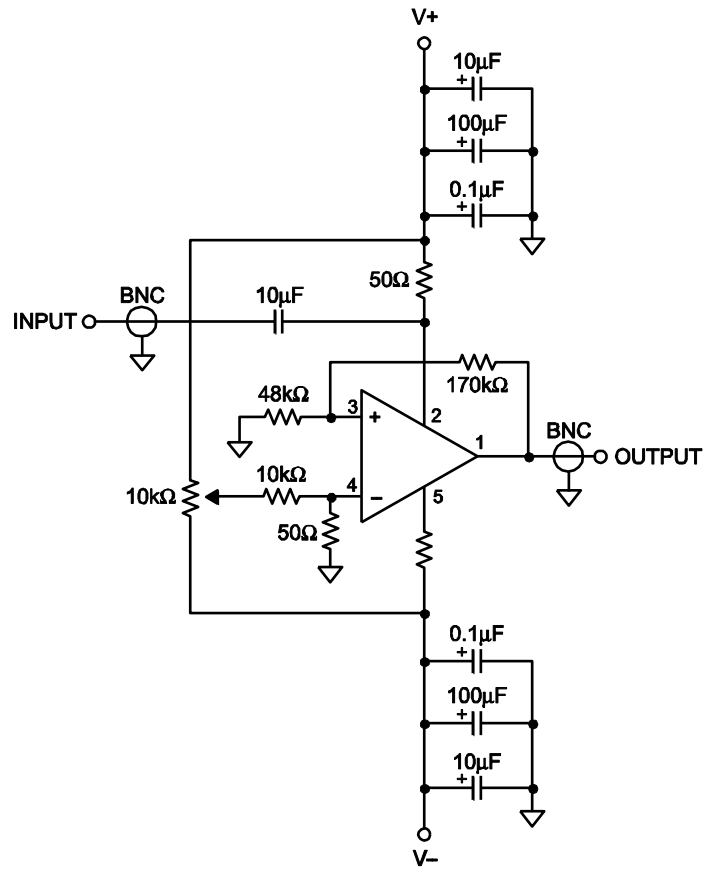
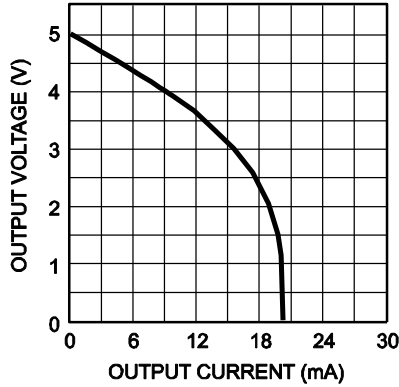

Figure 2—Positive Power Supply Rejection Ratio Measurement

TYPICAL PERFORMANCE CHARACTERISTICS

$T_A = +25^\circ\text{C}$, unless otherwise noted.

Output Voltage vs. Output Current
Sourcing



Output Voltage vs. Output Current
Sinking

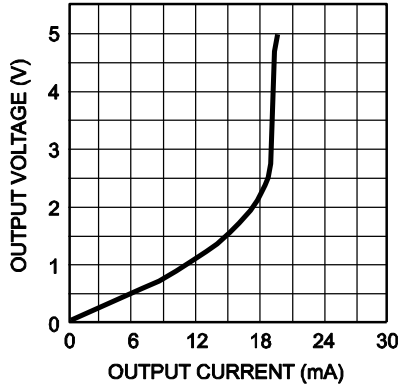

Short Circuit Current vs. Supply Voltage
Sourcing

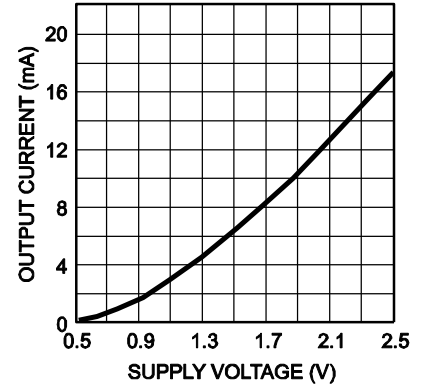

Short Circuit Current vs. Supply Voltage
Sinking

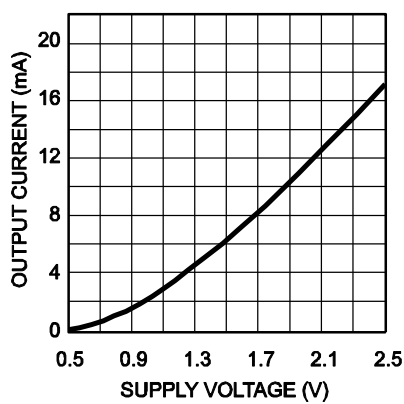

Offset Voltage vs. Common Mode Voltage
 $R_{FB} = 50\text{k}\Omega$, $V_- = -5\text{V}$ to 0V ,
 $V_+ = 0\text{V}$ to $+5\text{V}$

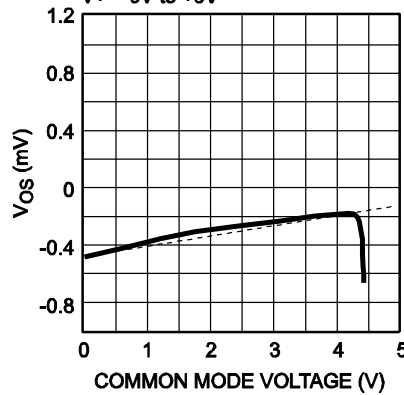

Offset Voltage vs. Supply Voltage
 $R_{FB} = 50\text{k}\Omega$, $V_- = -2.5\text{V}$ to 0V ,
 $V_+ = +2.5\text{V}$ to 0V

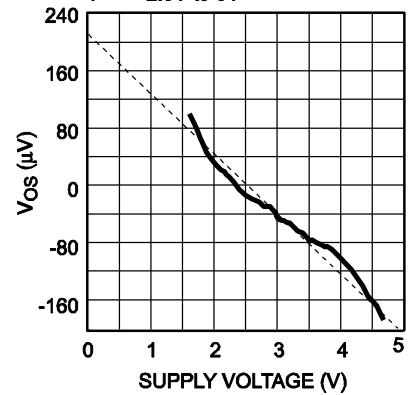

TYPICAL PERFORMANCE CHARACTERISTICS (continued)
 $T_A = +25^\circ\text{C}$, unless otherwise noted.

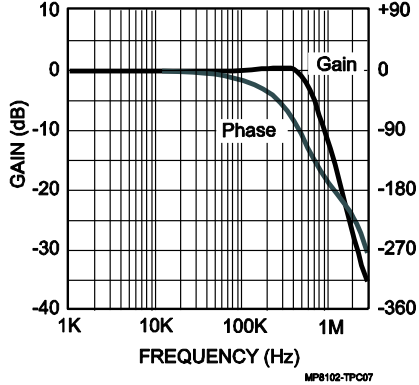
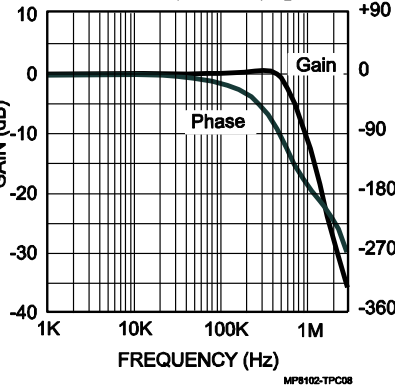
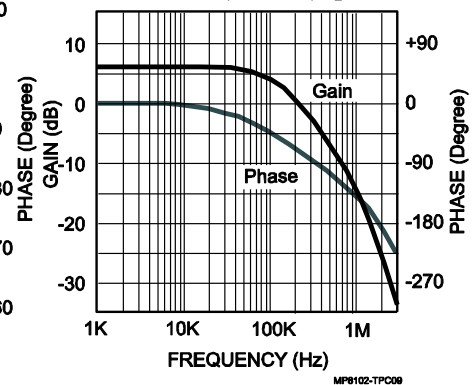
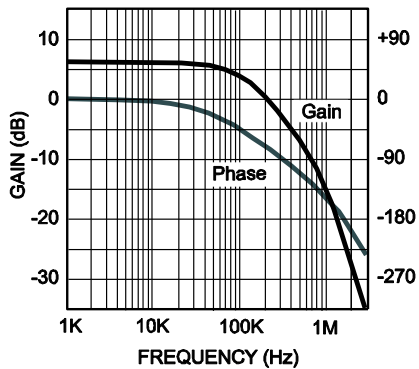
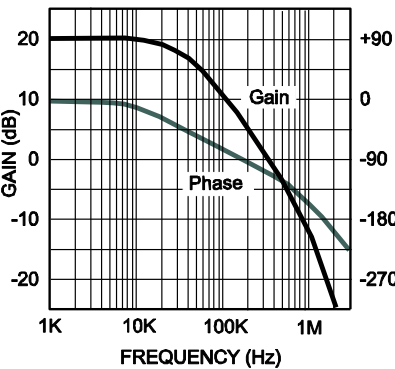
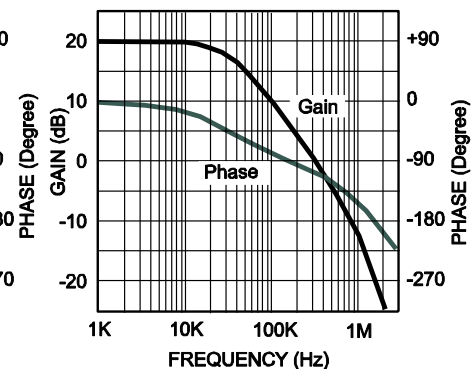
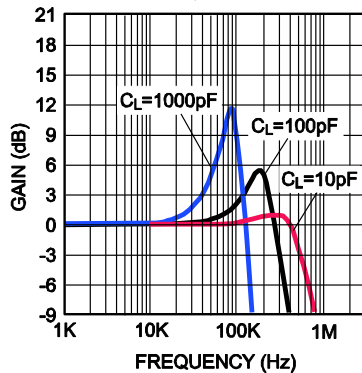
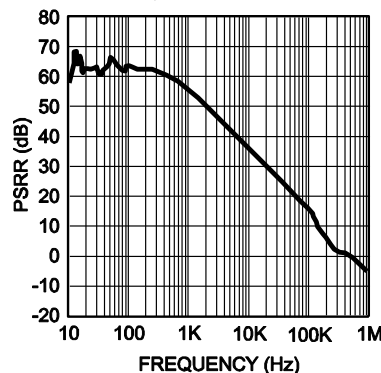
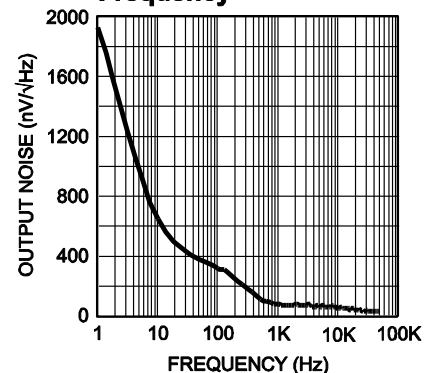
Gain Bandwidth and Phase Margin
 $V_{\pm} = \pm 1.35\text{V}$, Gain = 1, $R_L = 1\text{M}\Omega$

Gain Bandwidth and Phase Margin
 $V_{\pm} = \pm 2.50\text{V}$, Gain = 1, $R_L = 1\text{M}\Omega$

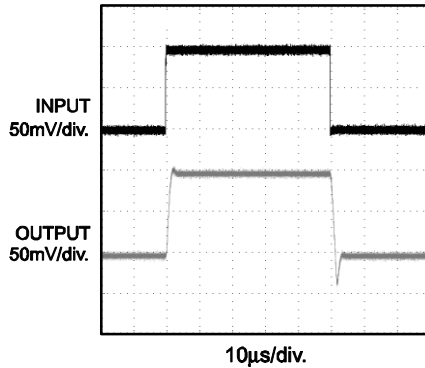
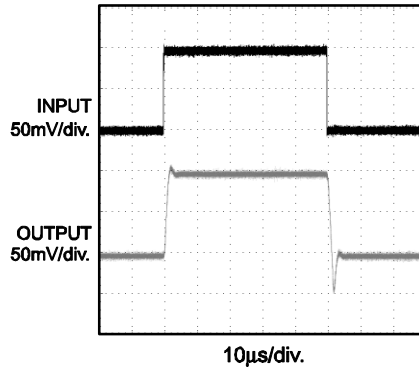
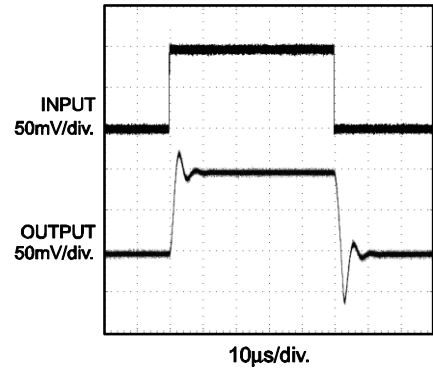
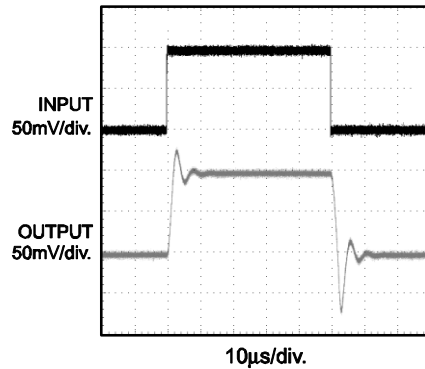
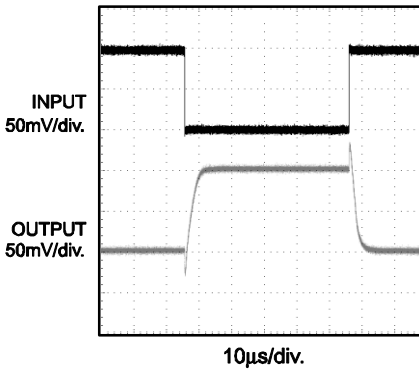
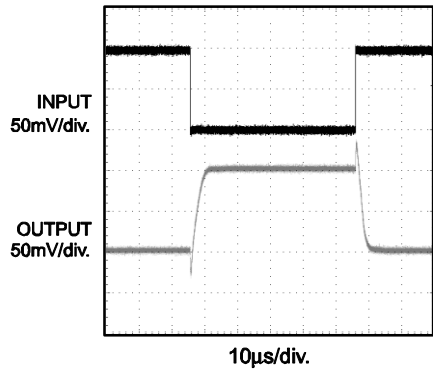
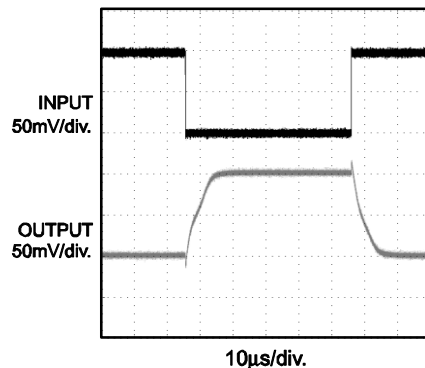
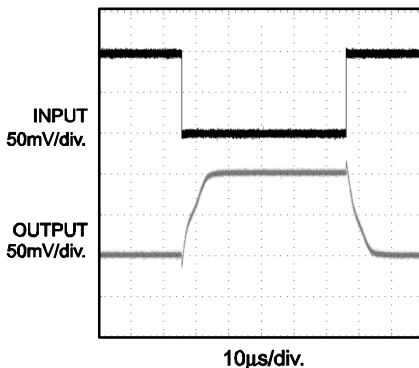
Gain Bandwidth and Phase Margin
 $V_{\pm} = \pm 1.35\text{V}$, Gain = 2, $R_L = 1\text{M}\Omega$

Gain Bandwidth and Phase Margin
 $V_{\pm} = \pm 2.50\text{V}$, Gain = 2, $R_L = 1\text{M}\Omega$

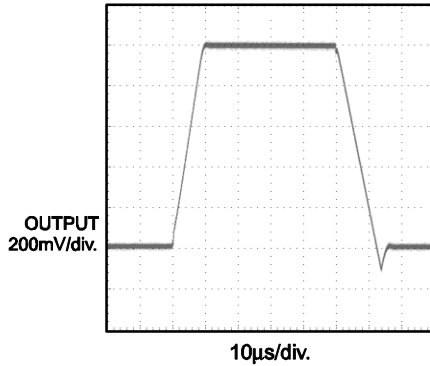
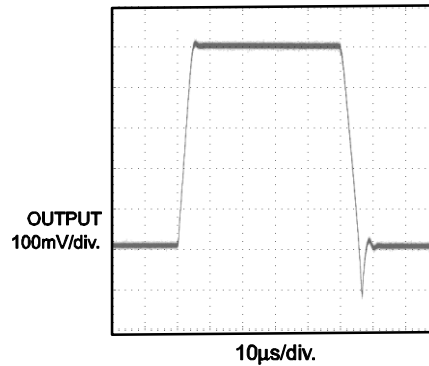
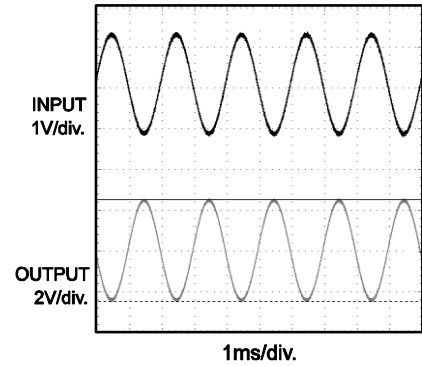
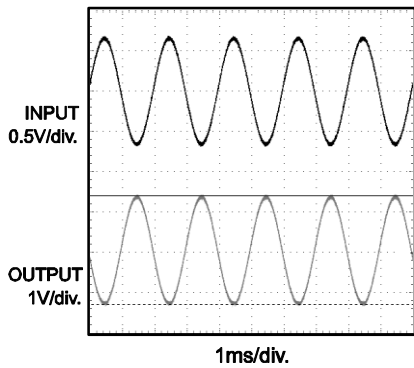
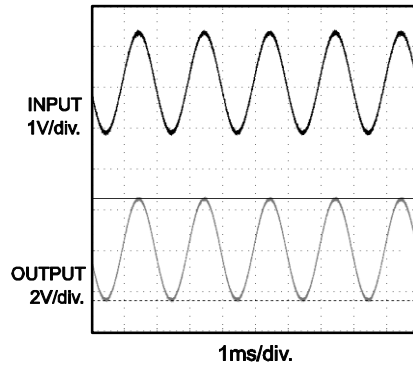
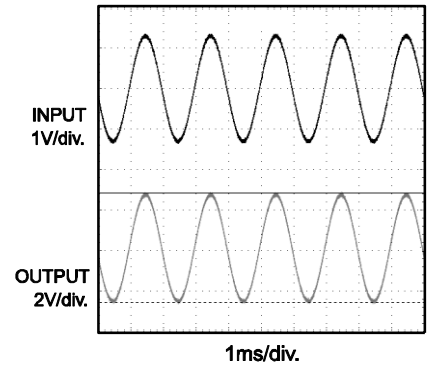
Gain Bandwidth and Phase Margin
 $V_{\pm} = \pm 1.35\text{V}$, Gain = 10, $R_L = 1\text{M}\Omega$

Gain Bandwidth and Phase Margin
 $V_{\pm} = \pm 2.50\text{V}$, Gain = 10, $R_L = 1\text{M}\Omega$

Close-Loop Unity Gain Frequency Response
 $V_{\pm} = \pm 2.50\text{V}$, Gain = 1

PSRR vs. Frequency
 $V_- = -2.5\text{V}$, $V_+ = 2.5\text{V}$

Output Noise vs. Frequency

TYPICAL PERFORMANCE CHARACTERISTICS (continued)
 $T_A = +25^\circ\text{C}$, unless otherwise noted.

Small Signal Pulse Response
 $A_V = 1, V_+ = 2.5\text{V}, V_- = -2.5\text{V}$
 $R_L = 1\text{M}\Omega, C_L = 8\text{pF}$

Small Signal Pulse Response
 $A_V = 1, V_+ = 1.25\text{V}, V_- = -1.25\text{V}$
 $R_L = 1\text{M}\Omega, C_L = 8\text{pF}$

Small Signal Pulse Response
 $A_V = 1, V_+ = 2.5\text{V}, V_- = -2.5\text{V}$
 $R_L = 1\text{M}\Omega, C_L = 50\text{pF}$

Small Signal Pulse Response
 $A_V = 1, V_+ = 1.25\text{V}, V_- = -1.25\text{V}$
 $R_L = 1\text{M}\Omega, C_L = 50\text{pF}$

Small Signal Pulse Response
 $A_V = -1, V_+ = 2.5\text{V}, V_- = -2.5\text{V}$
 $R_L = 1\text{M}\Omega, C_L = 8\text{pF}$

Small Signal Pulse Response
 $A_V = -1, V_+ = 1.25\text{V}, V_- = -1.25\text{V}$
 $R_L = 1\text{M}\Omega, C_L = 8\text{pF}$

Small Signal Pulse Response
 $A_V = -1, V_+ = 2.5\text{V}, V_- = -2.5\text{V}$
 $R_L = 5\text{k}\Omega, C_L = 8\text{pF}$

Small Signal Pulse Response
 $A_V = -1, V_+ = 1.25\text{V}, V_- = -1.25\text{V}$
 $R_L = 5\text{k}\Omega, C_L = 8\text{pF}$

TYPICAL PERFORMANCE CHARACTERISTICS (continued)
 $T_A = +25^\circ\text{C}$, unless otherwise noted.

Large Signal Pulse Response
 $A_v = 1$, $V_+ = 2.5\text{V}$, $V_- = -2.5\text{V}$
 $R_L = 1\text{M}\Omega$, $C_L = 8\text{pF}$

Large Signal Pulse Response
 $A_v = 1$, $V_+ = 1.25\text{V}$, $V_- = -1.25\text{V}$
 $R_L = 1\text{M}\Omega$, $C_L = 8\text{pF}$

Rail to Rail Output Operation
 $A_v = -2$, $V_+ = 2.5\text{V}$, $V_- = -2.5\text{V}$
 $R_L = 1\text{M}\Omega$, $C_L = 8\text{pF}$

Rail to Rail Output Operation
 $A_v = -2$, $V_+ = 1.25\text{V}$, $V_- = -1.25\text{V}$
 $R_L = 1\text{M}\Omega$, $C_L = 8\text{pF}$

Rail to Rail Output Operation
 $A_v = 2$, $V_+ = 2.5\text{V}$, $V_- = -2.5\text{V}$
 $R_L = 1\text{M}\Omega$, $C_L = 8\text{pF}$

Rail to Rail Output Operation
 $A_v = 2$, $V_+ = 1.25\text{V}$, $V_- = -1.25\text{V}$
 $R_L = 1\text{M}\Omega$, $C_L = 8\text{pF}$

APPLICATION INFORMATION

Power Supply Bypassing

Regular supply bypassing techniques are recommended. A 10 μ F capacitor in parallel with a 0.1 μ F capacitor on both the positive and negative supplies is ideal. For the best

performance, all bypassing capacitors should be located as close to the op amp as possible and all capacitors should be low ESL (Equivalent Series Inductance) and low ESR (Equivalent Series Resistance). Surface mount ceramic capacitors are ideal.

PACKAGE INFORMATION

TSOT23-5

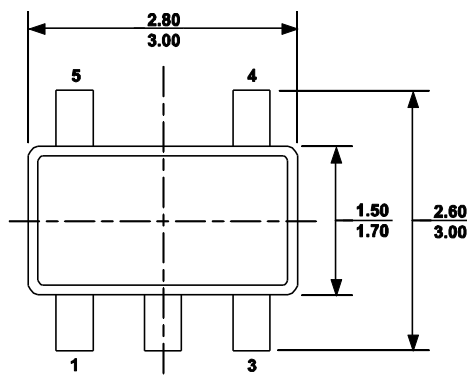

TOP VIEW

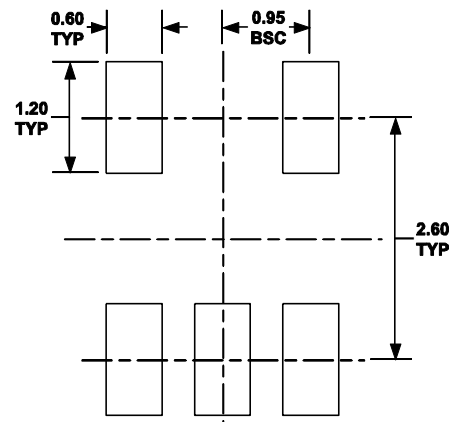

RECOMMENDED LAND PATTERN

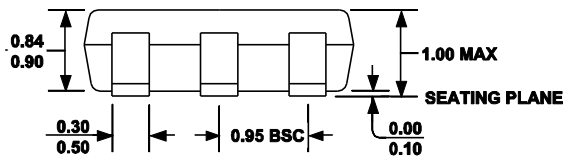

FRONT VIEW

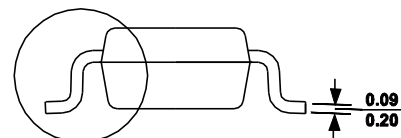

SIDE VIEW

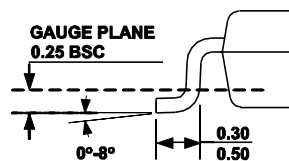

DETAIL "A"

NOTE:

- 1) ALL DIMENSIONS ARE IN MILLIMETERS.
- 2) PACKAGE LENGTH DOES NOT INCLUDE MOLD FLASH, PROTRUSION OR GATE BURR.
- 3) PACKAGE WIDTH DOES NOT INCLUDE INTERLEAD FLASH OR PROTRUSION.
- 4) LEAD COPLANARITY (BOTTOM OF LEADS AFTER FORMING) SHALL BE 0.10 MILLIMETERS MAX.
- 5) DRAWING CONFORMS TO JEDEC MO-193, VARIATION AA.
- 6) DRAWING IS NOT TO SCALE.

NOTICE: The information in this document is subject to change without notice. Users should warrant and guarantee that third party Intellectual Property rights are not infringed upon when integrating MPS products into any application. MPS will not assume any legal responsibility for any said applications.