

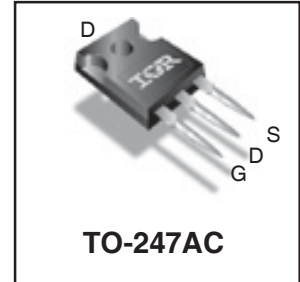
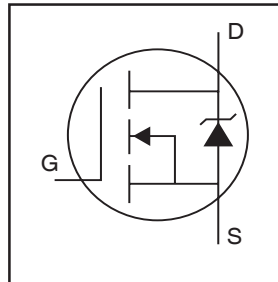
**PDP SWITCH**

**IRFP4229PbF**

**Features**

- Advanced Process Technology
- Key Parameters Optimized for PDP Sustain, Energy Recovery and Pass Switch Applications
- Low  $E_{PULSE}$  Rating to Reduce Power Dissipation in PDP Sustain, Energy Recovery and Pass Switch Applications
- Low  $Q_G$  for Fast Response
- High Repetitive Peak Current Capability for Reliable Operation
- Short Fall & Rise Times for Fast Switching
- 175°C Operating Junction Temperature for Improved Ruggedness
- Repetitive Avalanche Capability for Robustness and Reliability

Key Parameters		
$V_{DS\ min}$	250	V
$V_{DS\ (Avalanche)\ typ.}$	300	V
$R_{DS(ON)\ typ.\ @\ 10V}$	38	mΩ
$I_{RP\ max\ @\ T_C = 100^\circ C}$	87	A
$T_J\ max$	175	°C



G	D	S
Gate	Drain	Source

**Description**

This HEXFET® Power MOSFET is specifically designed for Sustain; Energy Recovery & Pass switch applications in Plasma Display Panels. This MOSFET utilizes the latest processing techniques to achieve low on-resistance per silicon area and low  $E_{PULSE}$  rating. Additional features of this MOSFET are 175°C operating junction temperature and high repetitive peak current capability. These features combine to make this MOSFET a highly efficient, robust and reliable device for PDP driving applications.

**Absolute Maximum Ratings**

	Parameter	Max.	Units
$V_{GS}$	Gate-to-Source Voltage	±30	V
$I_D @ T_C = 25^\circ C$	Continuous Drain Current, $V_{GS} @ 10V$	44	A
$I_D @ T_C = 100^\circ C$	Continuous Drain Current, $V_{GS} @ 10V$	31	
$I_{DM}$	Pulsed Drain Current ①	180	
$I_{RP} @ T_C = 100^\circ C$	Repetitive Peak Current ⑤	87	
$P_D @ T_C = 25^\circ C$	Power Dissipation	310	W
$P_D @ T_C = 100^\circ C$	Power Dissipation	150	
	Linear Derating Factor	2.0	W/°C
$T_J$	Operating Junction and	-40 to + 175	°C
$T_{STG}$	Storage Temperature Range		
	Soldering Temperature for 10 seconds		
	Mounting Torque, 6-32 or M3 Screw	10lb·in (1.1N·m)	N

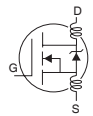
**Thermal Resistance**

	Parameter	Typ.	Max.	Units
$R_{\theta JC}$	Junction-to-Case ④	—	0.49	°C/W
$R_{\theta CS}$	Case-to-Sink, Flat, Greased Surface	0.24	—	
$R_{\theta JA}$	Junction-to-Ambient ④	—	40	

Notes ① through ⑤ are on page 8

## Electrical Characteristics @ $T_J = 25^\circ\text{C}$ (unless otherwise specified)

	Parameter	Min.	Typ.	Max.	Units	Conditions
$BV_{DSS}$	Drain-to-Source Breakdown Voltage	250	—	—	V	$V_{GS} = 0V, I_D = 250\mu A$
$\Delta BV_{DSS}/\Delta T_J$	Breakdown Voltage Temp. Coefficient	—	210	—	mV/°C	Reference to $25^\circ\text{C}, I_D = 1mA$
$R_{DS(on)}$	Static Drain-to-Source On-Resistance	—	38	46	mΩ	$V_{GS} = 10V, I_D = 26A$ ③
$V_{GS(th)}$	Gate Threshold Voltage	3.0	—	5.0	V	$V_{DS} = V_{GS}, I_D = 250\mu A$
$\Delta V_{GS(th)}/\Delta T_J$	Gate Threshold Voltage Coefficient	—	-14	—	mV/°C	
$I_{DSS}$	Drain-to-Source Leakage Current	—	—	20	μA	$V_{DS} = 250V, V_{GS} = 0V$
		—	—	1.0	mA	$V_{DS} = 250V, V_{GS} = 0V, T_J = 125^\circ\text{C}$
$I_{GSS}$	Gate-to-Source Forward Leakage	—	—	100	nA	$V_{GS} = 20V$
	Gate-to-Source Reverse Leakage	—	—	-100	nA	$V_{GS} = -20V$
$g_{fs}$	Forward Transconductance	83	—	—	S	$V_{DS} = 25V, I_D = 26A$
$Q_g$	Total Gate Charge	—	72	110	nC	$V_{DD} = 125V, I_D = 26A, V_{GS} = 10V$ ③
$Q_{gd}$	Gate-to-Drain Charge	—	26	—	nC	
$t_{d(on)}$	Turn-On Delay Time	—	25	—	ns	$V_{DD} = 125V, V_{GS} = 10V$ ③
$t_r$	Rise Time	—	27	—	ns	$I_D = 26A$
$t_{d(off)}$	Turn-Off Delay Time	—	44	—	ns	$R_G = 5.0\Omega$
$t_f$	Fall Time	—	19	—	ns	See Fig. 22
$t_{st}$	Shoot Through Blocking Time	100	—	—	ns	$V_{DD} = 200V, V_{GS} = 15V, R_G = 4.7\Omega$
$E_{PULSE}$	Energy per Pulse	—	790	—	μJ	$L = 220nH, C = 0.3\mu F, V_{GS} = 15V$ $V_{DS} = 200V, R_G = 4.7\Omega, T_J = 25^\circ\text{C}$
		—	1390	—	μJ	$L = 220nH, C = 0.3\mu F, V_{GS} = 15V$ $V_{DS} = 200V, R_G = 4.7\Omega, T_J = 100^\circ\text{C}$
$C_{iss}$	Input Capacitance	—	4560	—	pF	$V_{GS} = 0V$
$C_{oss}$	Output Capacitance	—	390	—	pF	$V_{DS} = 25V$
$C_{riss}$	Reverse Transfer Capacitance	—	100	—	pF	$f = 1.0MHz,$
$C_{oss\ eff.}$	Effective Output Capacitance	—	290	—	pF	$V_{GS} = 0V, V_{DS} = 0V\ to\ 200V$
$L_D$	Internal Drain Inductance	—	5.0	—	nH	Between lead, 6mm (0.25in.)
$L_S$	Internal Source Inductance	—	13	—	nH	from package and center of die contact

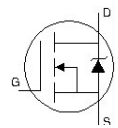


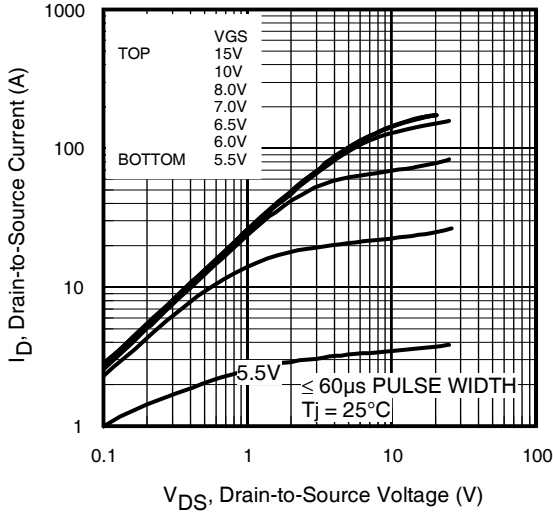
## Avalanche Characteristics

	Parameter	Typ.	Max.	Units
$E_{AS}$	Single Pulse Avalanche Energy ②	—	300	mJ
$E_{AR}$	Repetitive Avalanche Energy ①	—	31	mJ
$V_{DS(Avalanche)}$	Repetitive Avalanche Voltage ①	300	—	V
$I_{AS}$	Avalanche Current ②	—	26	A

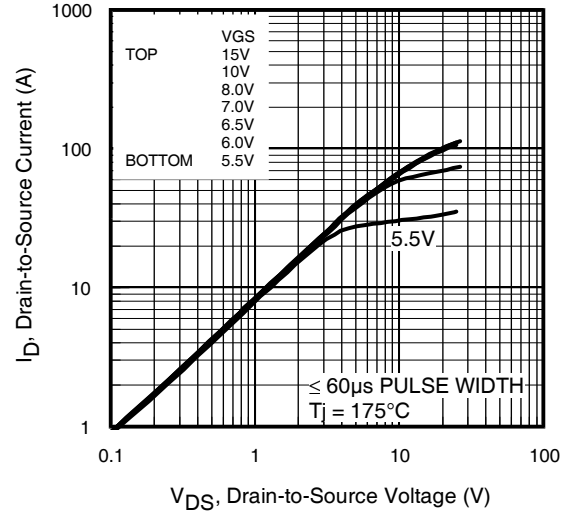
## Diode Characteristics

	Parameter	Min.	Typ.	Max.	Units	Conditions
$I_S @ T_C = 25^\circ\text{C}$	Continuous Source Current (Body Diode)	—	—	44	A	MOSFET symbol showing the integral reverse p-n junction diode.
$I_{SM}$	Pulsed Source Current (Body Diode) ①	—	—	180	A	
$V_{SD}$	Diode Forward Voltage	—	—	1.3	V	$T_J = 25^\circ\text{C}, I_S = 26A, V_{GS} = 0V$ ③
$t_{rr}$	Reverse Recovery Time	—	190	290	ns	$T_J = 25^\circ\text{C}, I_F = 26A, V_{DD} = 50V$
$Q_{rr}$	Reverse Recovery Charge	—	840	1260	nC	$di/dt = 100A/\mu s$ ③

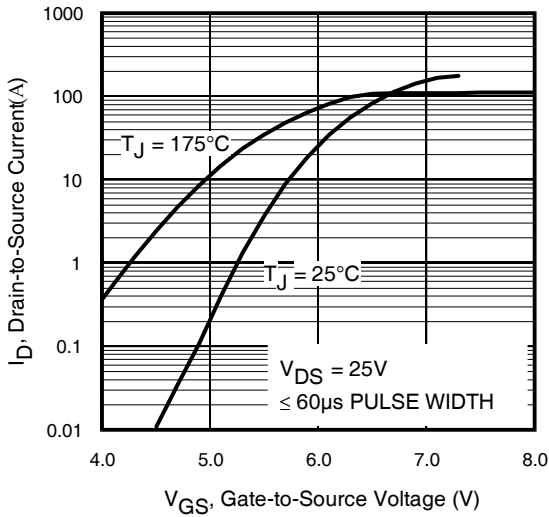




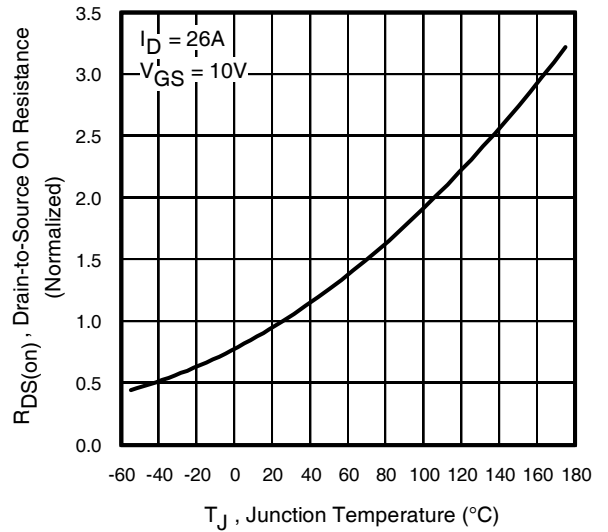
**Fig 1.** Typical Output Characteristics



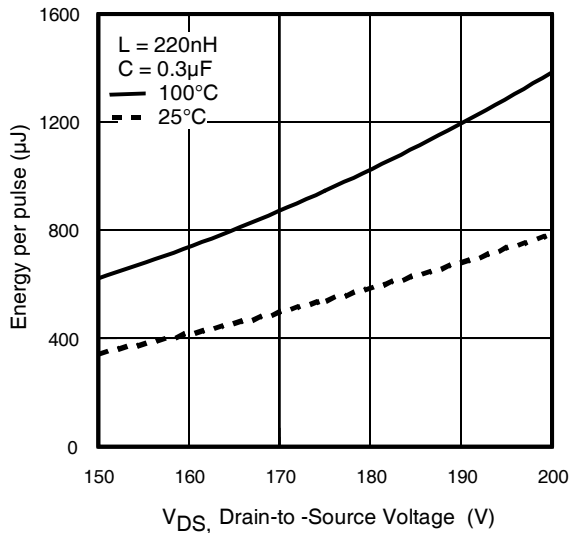
**Fig 2.** Typical Output Characteristics



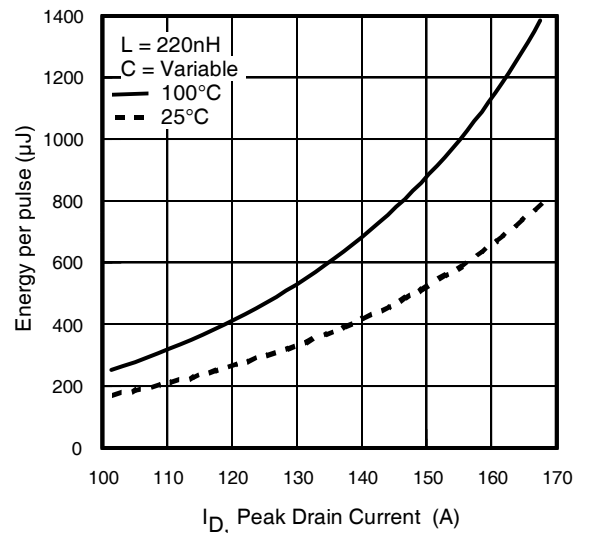
**Fig 3.** Typical Transfer Characteristics



**Fig 4.** Normalized On-Resistance vs. Temperature

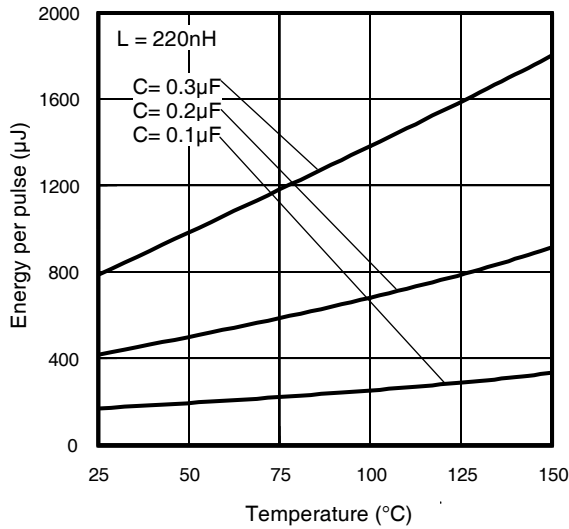


**Fig 5.** Typical  $E_{PULSE}$  vs. Drain-to-Source Voltage

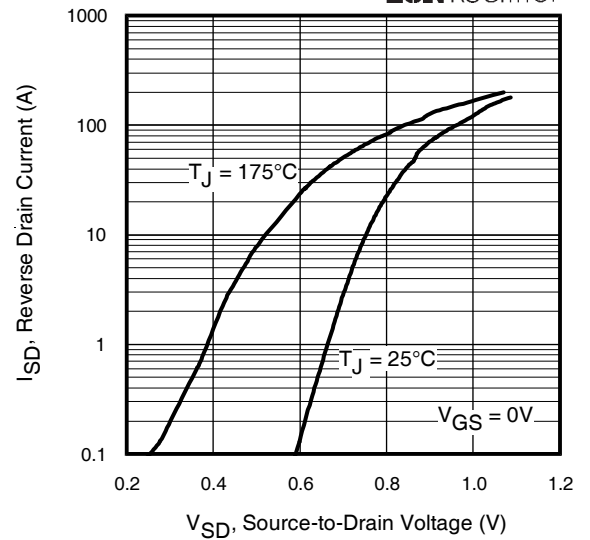


**Fig 6.** Typical  $E_{PULSE}$  vs. Drain Current

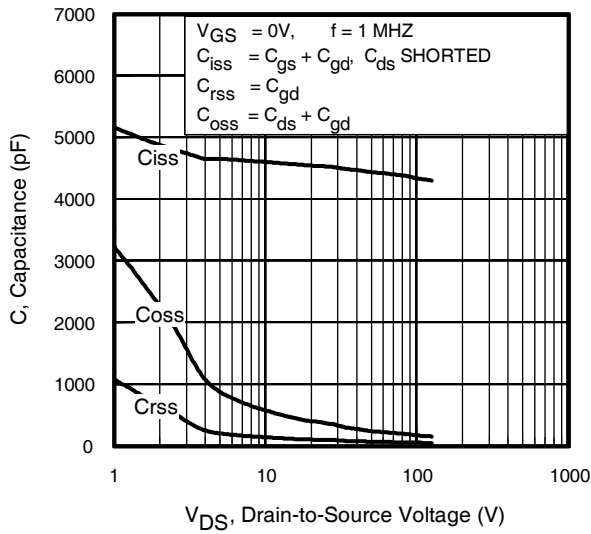
# IRFP4229PbF



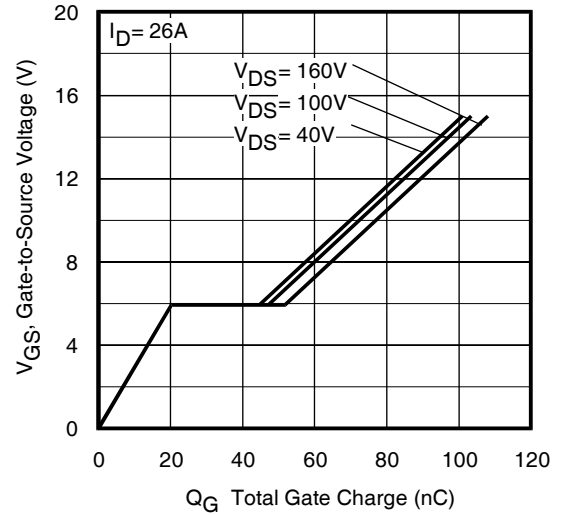
**Fig 7.** Typical  $E_{PULSE}$  vs. Temperature



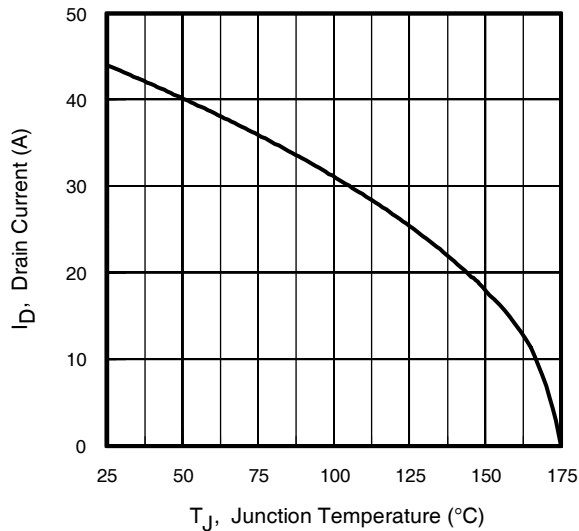
**Fig 8.** Typical Source-Drain Diode Forward Voltage



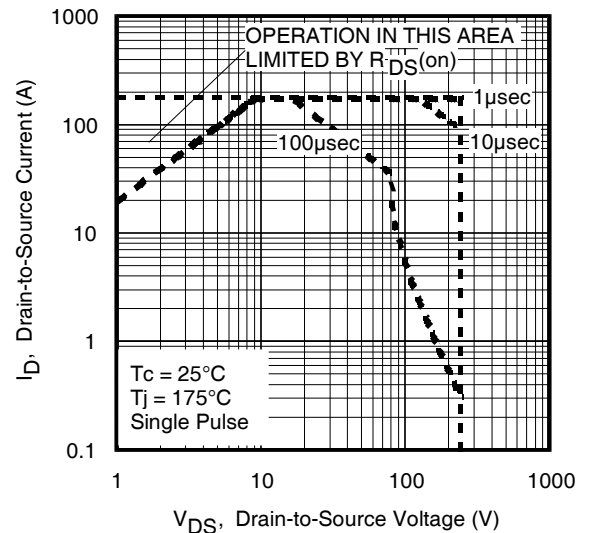
**Fig 9.** Typical Capacitance vs. Drain-to-Source Voltage



**Fig 10.** Typical Gate Charge vs. Gate-to-Source Voltage



**Fig 11.** Maximum Drain Current vs. Case Temperature



**Fig 12.** Maximum Safe Operating Area

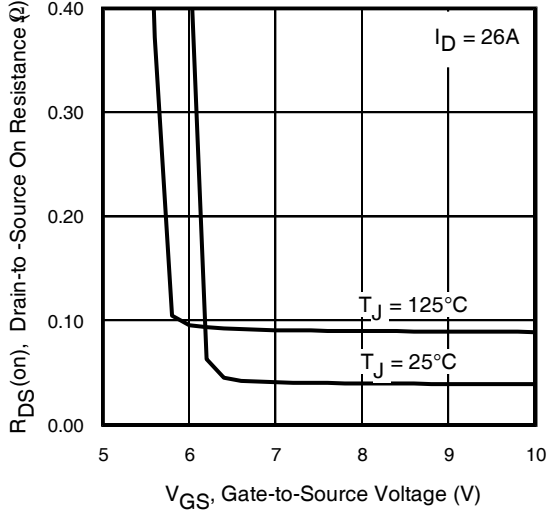


Fig 13. On-Resistance Vs. Gate Voltage

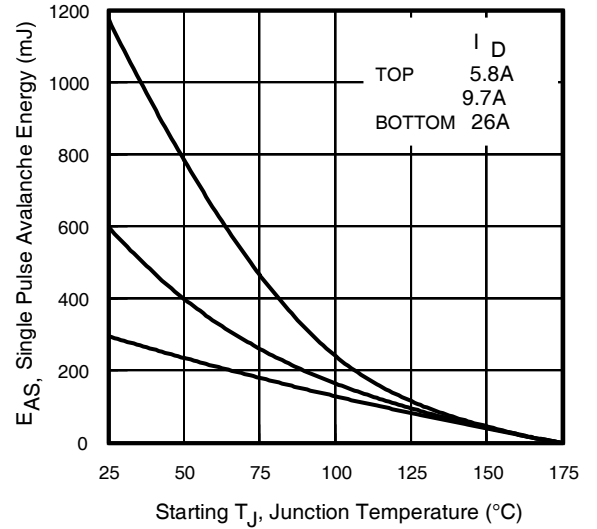


Fig 14. Maximum Avalanche Energy Vs. Temperature

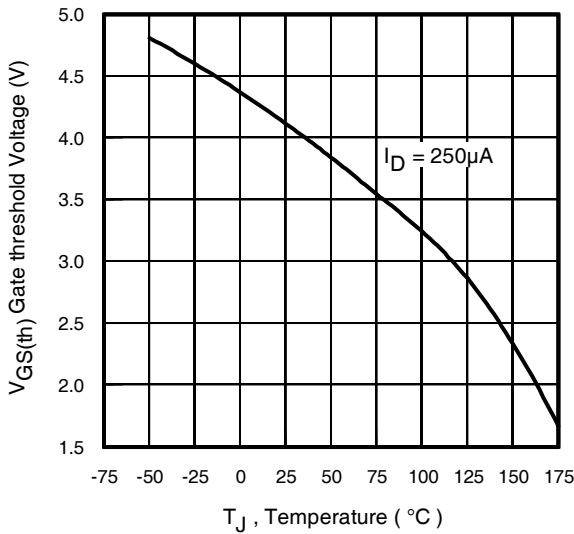


Fig 15. Threshold Voltage vs. Temperature

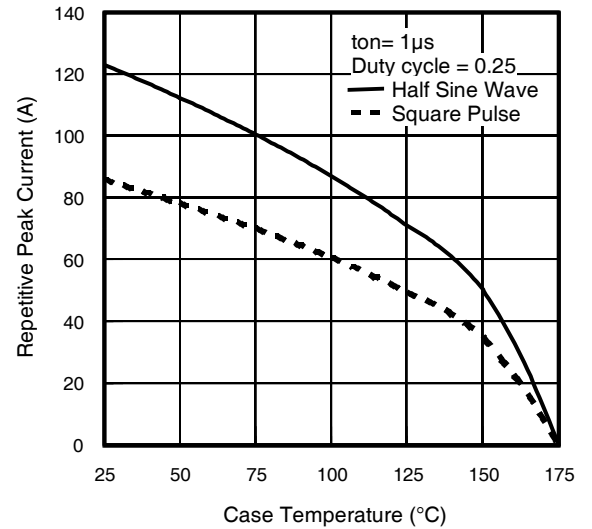


Fig 16. Typical Repetitive peak Current vs. Case temperature

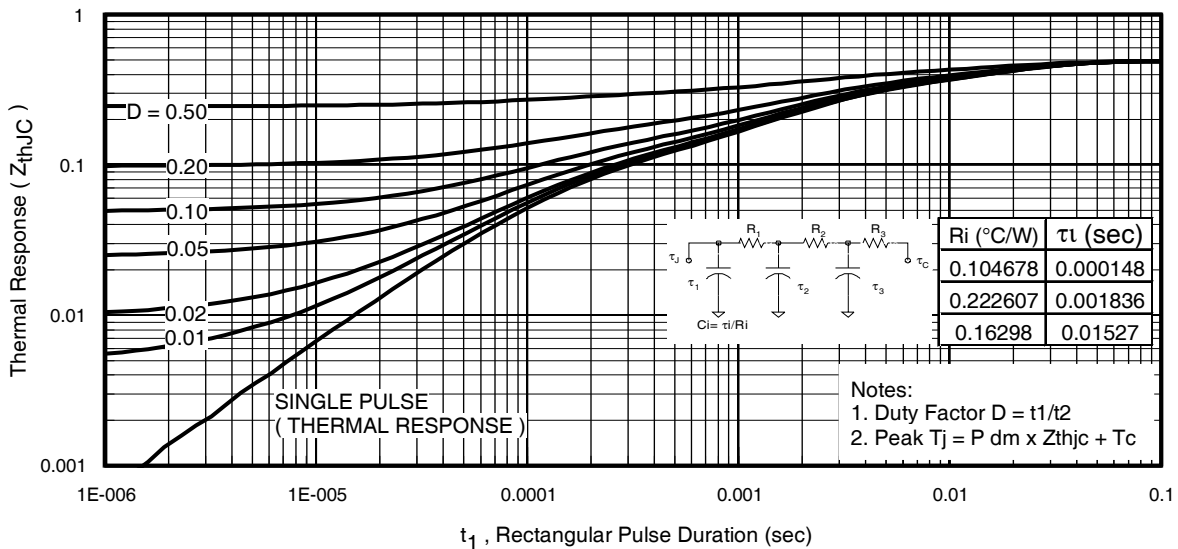
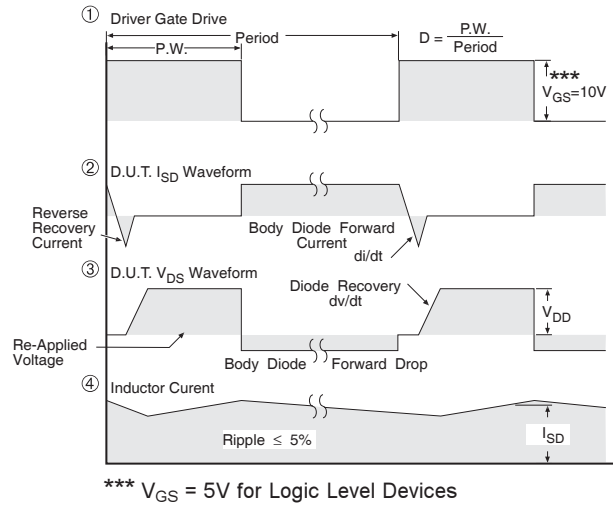


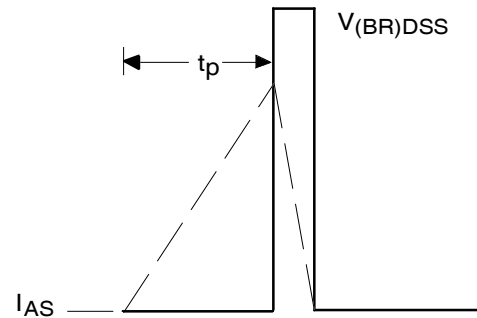
Fig 17. Maximum Effective Transient Thermal Impedance, Junction-to-Case



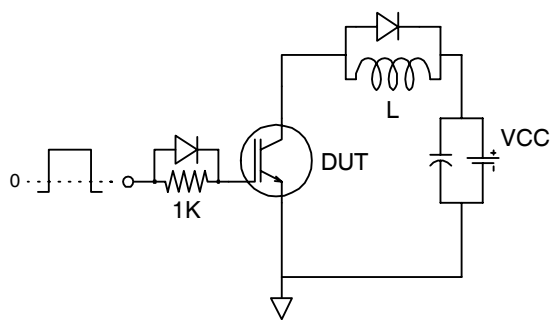
**Fig 18.** Diode Reverse Recovery Test Circuit for HEXFET® Power MOSFETs



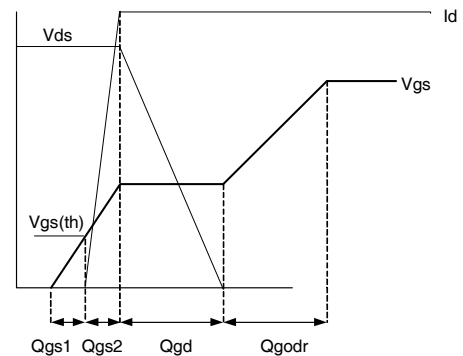
**Fig 19a.** Unclamped Inductive Test Circuit



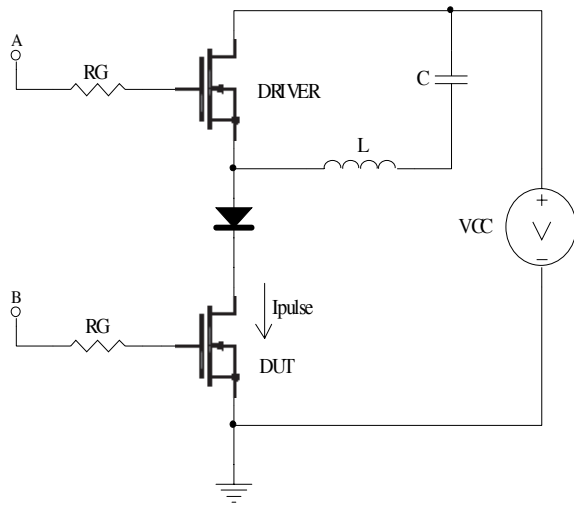
**Fig 19b.** Unclamped Inductive Waveforms



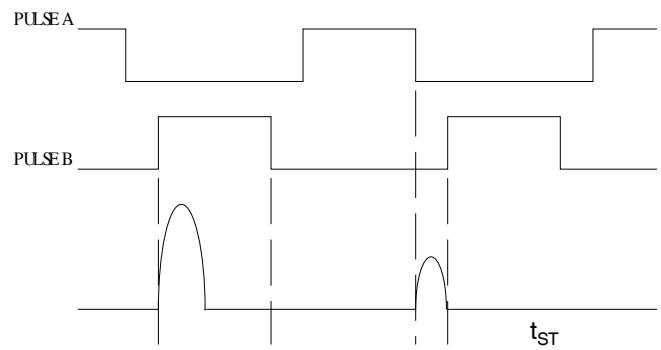
**Fig 20a.** Gate Charge Test Circuit



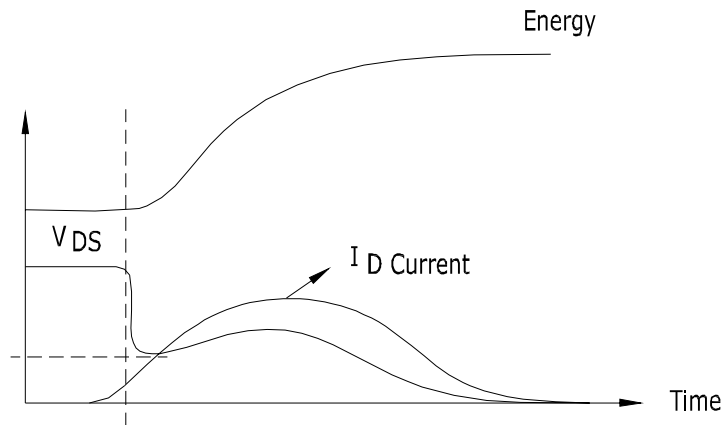
**Fig 20b.** Gate Charge Waveform



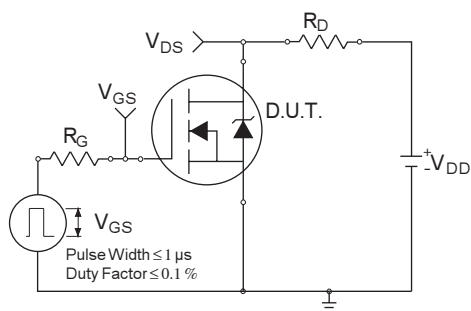
**Fig 21a.**  $t_{st}$  and  $E_{PULSE}$  Test Circuit



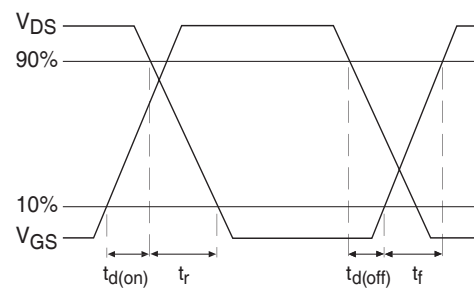
**Fig 21b.**  $t_{st}$  Test Waveforms



**Fig 21c.**  $E_{PULSE}$  Test Waveforms



**Fig 22a.** Switching Time Test Circuit

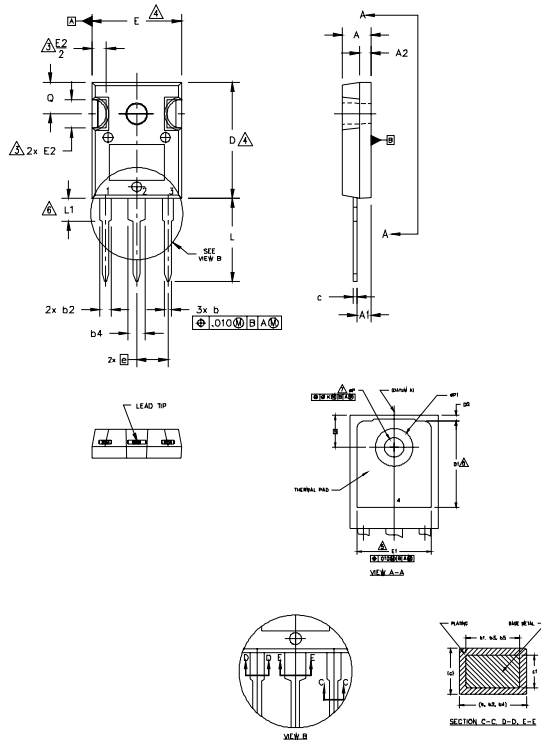


**Fig 22b.** Switching Time Waveforms

# IRFP4229PbF

## TO-247AC Package Outline

Dimensions are shown in millimeters (inches)



- NOTES:
1. DIMENSIONING AND TOLERANCING AS PER ASME Y14.5M 1994.
  2. DIMENSIONS ARE SHOWN IN INCHES.
  3. CONTOUR OF SLOT OPTIONAL.
  4. DIMENSION D & E DO NOT INCLUDE MOLD FLASH. MOLD FLASH SHALL NOT EXCEED .005" (0.127) PER SIDE. THESE DIMENSIONS ARE MEASURED AT THE OUTERMOST EXTREMES OF THE PLASTIC BODY.
  5. THERMAL PAD CONTOUR OPTIONAL WITHIN DIMENSIONS D1 & E1.
  6. LEAD FINISH UNCONTROLLED IN L1.
  7. ØP TO HAVE A MAXIMUM DRAFT ANGLE OF 1.5 ° TO THE TOP OF THE PART WITH A MAXIMUM HOLE DIAMETER OF .154 INCH.
  8. OUTLINE CONFORMS TO JEDEC OUTLINE TO-247AC.

SYMBOL	DIMENSIONS				NOTES
	INCHES		MILLIMETERS		
	MIN.	MAX.	MIN.	MAX.	
A	.183	.209	4.65	5.31	
A1	.087	.102	2.21	2.59	
A2	.059	.098	1.50	2.49	
b	.039	.055	0.99	1.40	
b1	.039	.053	0.99	1.35	
b2	.065	.094	1.65	2.39	
b3	.065	.092	1.65	2.34	
b4	.102	.135	2.59	3.43	
b5	.102	.133	2.59	3.38	
c	.015	.035	0.38	0.89	
c1	.015	.033	0.38	0.84	
D	.776	.815	19.71	20.70	4
D1	.515	-	13.08	-	5
D2	.020	.053	0.51	1.35	
E	.602	.625	15.29	15.87	4
E1	.530	-	13.46	-	
E2	.178	.216	4.52	5.49	
e	.215 BSC		5.46 BSC		
Øk	.010		0.25		
L	.559	.634	14.20	16.10	
L1	.146	.169	3.71	4.29	
ØP	.140	.144	3.56	3.66	
ØP1	-	.291	-	7.39	
O	.209	.224	5.31	5.69	
S	.217 BSC		5.51 BSC		

**LEAD ASSIGNMENTS**

**HEXFET**

- 1.- GATE
- 2.- DRAIN
- 3.- SOURCE
- 4.- DRAIN

**IGBTs, CoPACK**

- 1.- GATE
- 2.- COLLECTOR
- 3.- EMITTER
- 4.- COLLECTOR

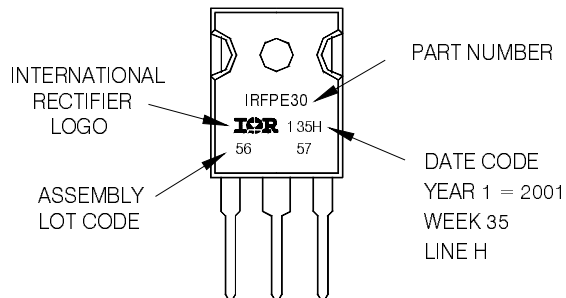
**DIODES**

- 1.- ANODE/OPEN
- 2.- CATHODE
- 3.- ANODE

## TO-247AC Part Marking Information

EXAMPLE: THIS IS AN IRFPE30  
WITH ASSEMBLY  
LOT CODE 5657  
ASSEMBLED ON WW 35, 2001  
IN THE ASSEMBLY LINE "H"

Note: "P" in assembly line position  
indicates "Lead-Free"



### TO-247AC package is not recommended for Surface Mount Application.

**Notes:**

1. Repetitive rating; pulse width limited by max. junction temperature.
2. Starting  $T_J = 25^\circ\text{C}$ ,  $L = 0.85\text{mH}$ ,  $R_G = 25\Omega$ ,  $I_{AS} = 26\text{A}$ .
3. Pulse width  $\leq 400\mu\text{s}$ ; duty cycle  $\leq 2\%$ .
4.  $R_\theta$  is measured at  $T_J$  of approximately  $90^\circ\text{C}$ .
5. Half sine wave with duty cycle = 0.25,  $t_{on} = 1\mu\text{sec}$ .

Note: For the most current drawing please refer to IR website at: <http://www.irf.com/package/>

Data and specifications subject to change without notice.  
This product has been designed and qualified for the Industrial market.  
Qualification Standards can be found on IR's Web site.



## **IMPORTANT NOTICE**

The information given in this document shall in no event be regarded as a guarantee of conditions or characteristics ("Beschaffheitsgarantie").

With respect to any examples, hints or any typical values stated herein and/or any information regarding the application of the product, Infineon Technologies hereby disclaims any and all warranties and liabilities of any kind, including without limitation warranties of non-infringement of intellectual property rights of any third party.

In addition, any information given in this document is subject to customer's compliance with its obligations stated in this document and any applicable legal requirements, norms and standards concerning customer's products and any use of the product of Infineon Technologies in customer's applications.

The data contained in this document is exclusively intended for technically trained staff. It is the responsibility of customer's technical departments to evaluate the suitability of the product for the intended application and the completeness of the product information given in this document with respect to such application.

For further information on the product, technology, delivery terms and conditions and prices please contact your nearest Infineon Technologies office ([www.infineon.com](http://www.infineon.com)).

## **WARNINGS**

Due to technical requirements products may contain dangerous substances. For information on the types in question please contact your nearest Infineon Technologies office.

Except as otherwise explicitly approved by Infineon Technologies in a written document signed by authorized representatives of Infineon Technologies, Infineon Technologies' products may not be used in any applications where a failure of the product or any consequences of the use thereof can reasonably be expected to result in personal injury.