

1

2

3

4

5

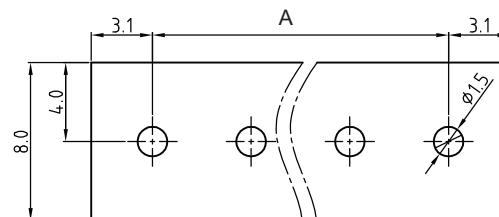

PCB LAYOUT - COMPONENT VIEW

TECHNICAL CHARACTERISTICS

MATERIAL
 INSULATOR: PA 66
 FLAMMABILITY RATING: UL94-V0
 COLOR: GREEN
 METAL HOUSING: BRASS (CuZn)
 TERMINAL SCREW: STEEL ZINC PLATING "+/-" SLOT TYPE
 WIRE GUARD: STAINLESS STEEL
 SURFACE OF SOLDER TAIL PLATING: TIN

ENVIRONMENTAL
 OPERATING TEMPERATURE: -40 UP TO 105°C
 COMPLIANCE: LEAD FREE AND ROHS

ELECTRICAL
 CURRENT RATING: 15 A
 WORKING VOLTAGE: 250 VAC
 WITHSTANDING VOLTAGE: 2.5 KV
 CONTACT RESISTANCE: 20 mOhm MAX

STANDARD
 CERTIFIED E315414

MECHANICAL
 SOLID WIRE: 24-14 AWG / 0.205-2.08 MM²
 STRANDED WIRE: 24-14 AWG / 0.205-2.08 MM²
 TORQUE: 2.6 Lb.In / 0.3 Nm

WIRE RANGE: WIRE STRIPE LENGTH: 5-6 MM
 SCREW: M2.5
 PITCH: 5.0 MM

SOLDERING
 JEDEC LEAD FREE WAVE SOLDERING

PACKAGING
 BOX

DIMENSION
 A = (NB. PINS - 1) x PITCH
 B = NB. PINS x PITCH

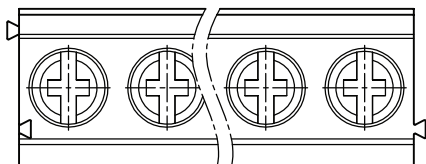
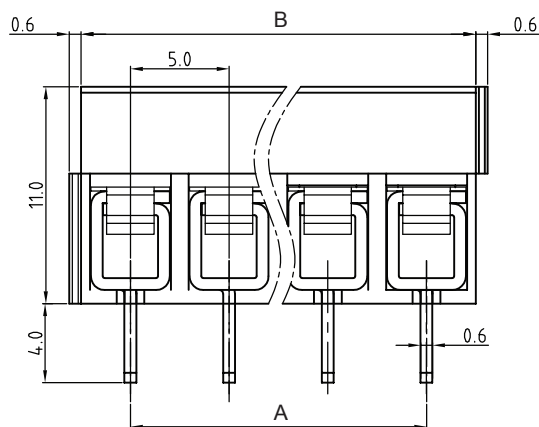
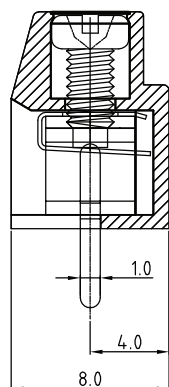

RoHS Compliant

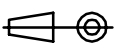
G				PROJECTION:	GENERAL TOLERANCE	 WÜRTH ELEKTRONIK	DESCRIPTION: SERIE 111 - 5.0MM HORIZONTAL ENTRY MODULAR WITH PRESSURE CLAMP - WR-TBL	SIZE A4
F	07-MAY-17	DRAWING	AK		.X = ± 0.30			
E	25-FEB-16	UPDATE	AK		APPROVAL: FBr	.XX = ± 0.20	WERI PART NO: 691 111 710 0xx	
D	06-SEP-09	PACKAGING	JC	UNIT: MM				
C	12-OCT-09	STANDARD	JP	SCALE:				
B	30-OCT-08	CHARACTERISTICS	JP	SHEET: 1/3				
A	30-OCT-07	PDF	EC	DRAW: MARVIN				
REV	DATE	FILE	BY					

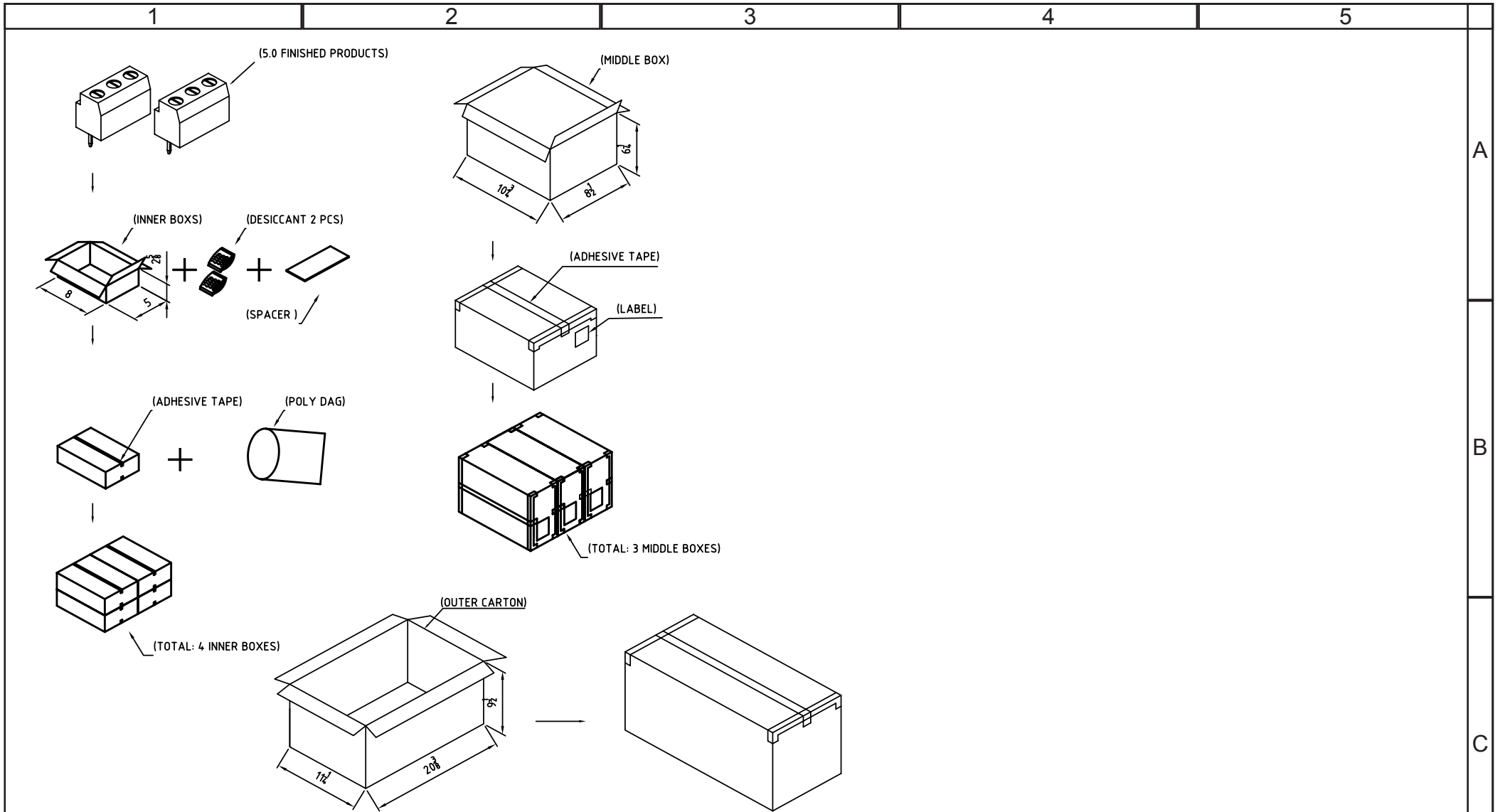

A

B

C

RoHS Compliant

G			
F			
E			
D			
C			
B			
A			
REV	DATE	FILE	BY

PROJECTION:

GENERAL TOLERANCE
 .X = ± 0.2
 .XX = ± 0.15

DESCRIPTION: SERIE 111 - 5.0MM HORIZONTAL ENTRY MODULAR WITH PRESSURE CLAMP - WR-TBL

APPROVAL: FBr

UNIT: MM
 SCALE:
 SHEET: 2/3
 DRAW: PEARL

WERI PART NO: 691 111 710 0xx

SIZE
A4

D

1

2

3

4

5

Cautions and Warnings:

This electronic component is designed and developed with the intention for use in general electronics equipments.

Before incorporating the components into any equipments in the field such as aerospace, aviation, nuclear control, submarine, transportation, (automotive control, train control, ship control), transportation signal, disaster prevention, medical, public information network etc. where higher safety and reliability are especially required or if there is possibility of direct damage or injury to human body, Würth Elektronik must be asked for a written approval.

In addition, even electronic component in general electronic equipments, when used in electrical circuits that require high safety, reliability functions or performance, the sufficient reliability evaluation-check for the safety must be performed before by the user before usage.

A

B

C

RoHS Compliant

G				PROJECTION: 	GENERAL TOLERANCE .X = +/- 0.2 .XX = +/- 0.15		
F							
E							
D							
C				APPROVAL: JC	UNIT: MM	DESCRIPTION: DISCLAIMER	SIZE A4
B					SCALE:		
A	10-SEP-14	PDF	QL		SHEET: 3/3	WERI PART NO: DISCLAIMER	
REV	DATE	FILE	BY		DRAW: QL		

D